

# AMBASSADOR 551 SERIES

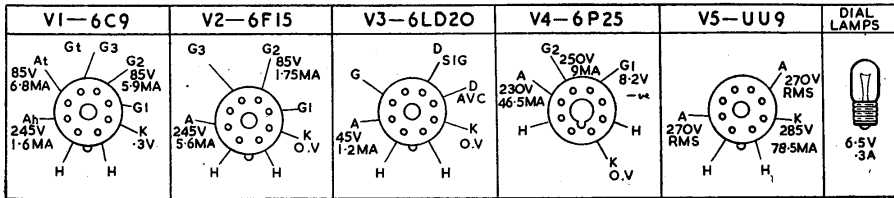

Five-valve three-band superhet with frame aerial and sockets for external aerial, pickup and extension speaker. Walnut finished table cabinet or bookshelf console. Made in AC model for 200-250V 40-60 c/s, and universal model for 200-250V AC/DC by R. N. Fitton Ltd., Brighouse, Yorkshire.

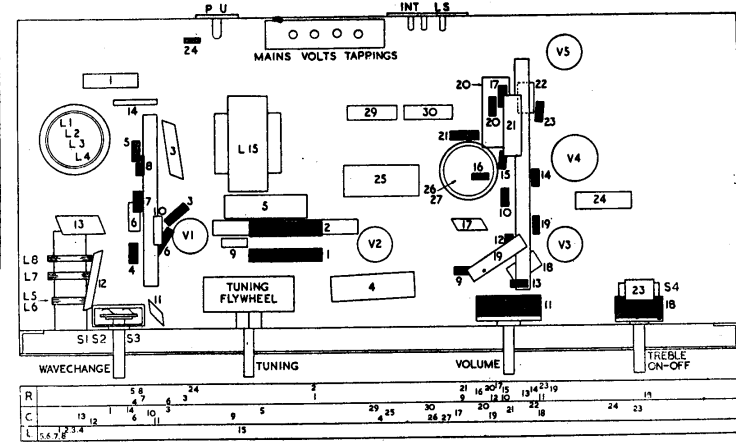
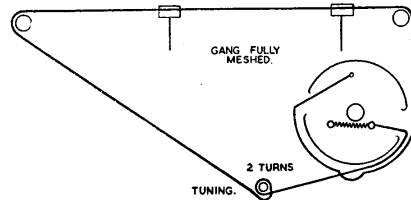
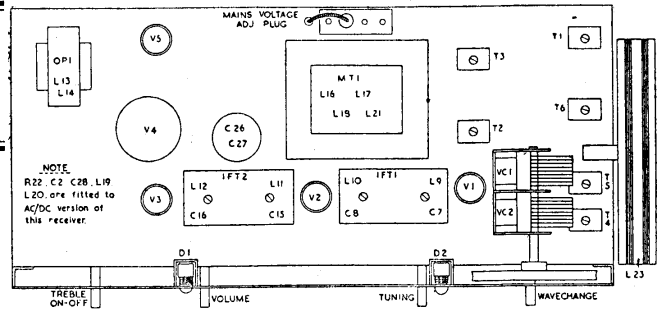

RESISTORS		R	Ohms	Watts	L	Ohms
R	Ohms	Watts	17	...	220K	...
1	...	22K	...	1	7	...
2	...	22K	...	1	8	...
3	...	33	...	1	9	...
4	...	470K	...	1	10	...
5	...	47K	...	1	11	...
6	...	47K	...	1	12	...
7	...	47K	...	1	13	...
8	...	22	...	1	14	...
9	...	47K	...	1	15	...
10	...	2.2M	...	1	16	...
11	...	500K Potentiometer	...	1	17	...
12	...	10M	...	1	18	...
13	...	22	...	1	19	...
14	...	1M	...	1	20	...
15	...	100K	...	1	21	...
16	...	100K	...	1	22	...

INDUCTORS		L	Ohms
1	...	25	Very low
2	...	Very low	Very low
3	...	2	Very low*
4	...	13.5	Very low
5	...	Very low	2.5
6	...	Very low	3

CAPACITORS		
C	Capacity	Type
1	...	.001 Tubular 1000V
2	...	.01 Tubular 1000V*
3	...	2400pF Silver Mica
4	...	.1 Tubular 350V
5	...	.1 Tubular 350V
6	...	.05 Tubular 350V*
7	...	120pF Mica
8	...	220pF Silver Mica
9	...	220pF Silver Mica
10	...	50pF Silver Mica
11	...	50pF Silver Mica
12	...	600pF Silver Mica
13	...	560pF Silver Mica
14	...	300pF Silver Mica
15	...	100pF Silver Mica
16	...	100pF Silver Mica
17	...	15pF Silver Mica
18	...	120pF Silver Mica
19	...	.02 Tubular 350V
20	...	.1 Tubular 350V
21	...	.05 Tubular 350V
22	...	.02 Tubular 350V
23	...	200pF Mica
24	...	.005 Tubular 1000V
25	...	50 Electrolytic 12V
26	...	32 Electrolytic 450V
27	...	16 Electrolytic 450V
28	...	32 Electrolytic 350V*
29	...	32 Electrolytic 350V*
30	...	.05 Tubular 1000V*

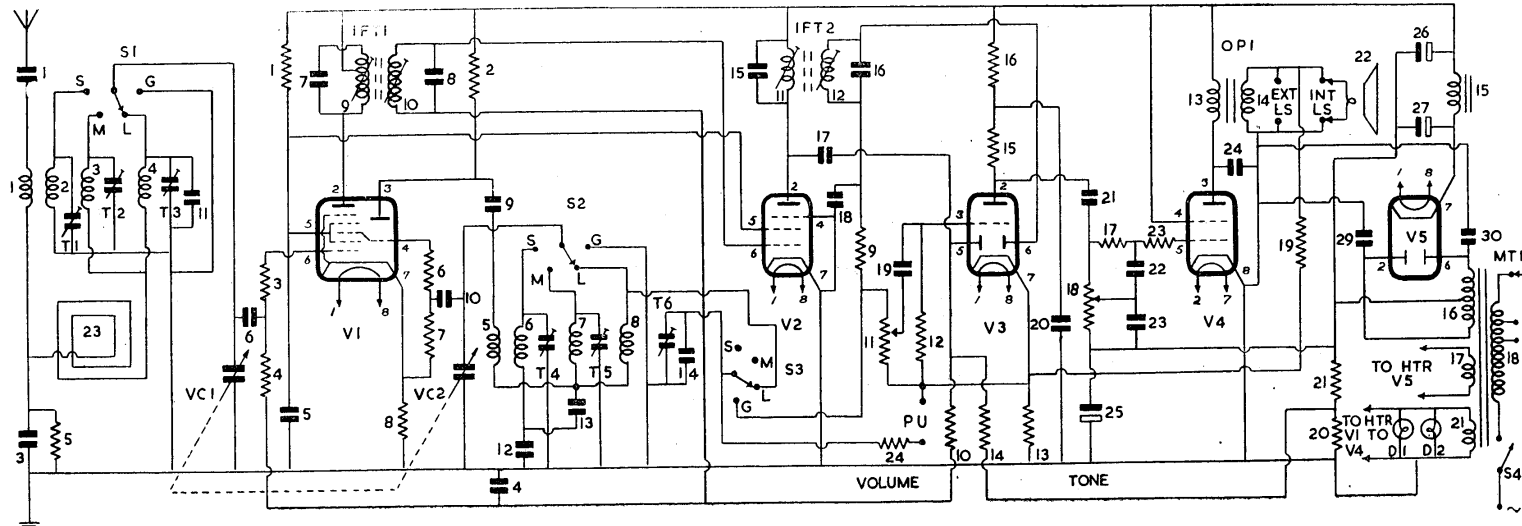

## AMBASSADOR 551—Continued

**AERIAL.** The receiver is fitted with an internal loop for the reception of the more powerful MW and LW stations. Sockets for an external aerial and earth are provided for SW reception and for weaker MW and LW transmissions.

External aerial signal is fed through isolating capacitor C1 to SW aerial coupling coil L1 and thence to frame aerial L23 which is connected to bottom end of MW and LW grid coils L3, L4 respectively. R5, C3 are associated with bottom end aerial feed circuit.

Grid coils L2 (SW), L3 (MW), L4 (LW), which are trimmed by T1, T2, T3-C11 respectively, are switched by S1 to aerial tuning capacitor VC1 and coupled through C6 and grid stopper R3 to g1 of triode-heptode frequency-changer V1.

AVC voltages and a small standing bias, decoupled by R10, C4 are applied through R4, R3 to V1. R8 provides a small degree of negative feed-back to cathode. Screen (g2, g4) voltage is obtained from R1 decoupled by C5. Suppressor is internally strapped to one side of cathode. Primary L9, C7 of IFT1 is in the heptode anode circuit.

**Oscillator** is connected in a tuned-grid shunt-fed circuit. Grid coils L6 (SW), L7 (MW), L8 (LW) trimmed by T4, T5, T6 and padded by C12 (SW) and C12, C13 (MW, LW), are switched by S2 to oscillator tuning capacitor VC2 and coupled by C10 through stopper R6 to oscillator grid.

The gram. switch is utilised to prevent absorption by the LW oscillator circuit on MW, S3 switching out T6, C14. This means that the PU, when left connected and R24 are across these trimmers but effect on LW operation is negligible.

Automatic bias is developed on C10 with R7 as leak. Anode reaction voltages are developed inductively on L5 (SW) and capacitively across padders C12, C13 on MW, LW bands, and are applied through C9 to oscillator anode of which R2 is load.

**IF amplifier** operates at 420kc/s. Secondary L10, C8 of IFT1 feeds signal together with AVC and standing bias voltages decoupled by R10, C4, to g1 of IF amplifier V2.

Cathode and suppressor are connected down to chassis and screen voltage is obtained from R1 decoupled by C5. Primary L11, C15 of IFT2 is in the anode circuit.

**Signal rectifier.** Secondary L12, C16 of IFT2 feeds signal to one diode of V3. R11, the volume control, is the diode load and R9, C18 an IF filter.

AVC signal at anode V2 is fed by C17 to second diode of V3. Load resistor R14 is returned to chassis through R20 in negative HT circuit to provide a delay voltage. Delay bias, plus AVC voltage, is fed through decoupling network R10, C4 to grids of V1, V2.

**Pickup.** Sockets are provided for connection of any high resistance magnetic or crystal pickup. Pickup signal is applied through R24 to S3 which in its gram. position switches signal to volume control R11. Earthy socket is connected to junction of bottom of R11 and cathode feedback resistor R13. When pickup is in use aerial and oscillator coils are switched out and their tuning capacitors VC1, VC2 are shorted down to chassis by S1, S2 respectively.

**AF amplifier.** Rectified signal on volume control R11 is fed by C19 to grid of triode section

of V3. Bias for grid is developed on C19 with R12 as leak resistor.

Negative feedback from secondary L14 of output matching transformer OP1 is applied to R13 in cathode of V3. R15 is anode load and R16, C20 provide HT decoupling.

**Output Stage.** C21 feeds signal at anode V3 through stoppers R17, R23 to beam-tetrode output amplifier V4. Grid resistor is potentiometer R18 which in conjunction with R17, C22, C23 provides variable top cut tone control. Cathode is at chassis potential, hence grid is provided with negative bias by connecting bottom end of grid load R18 to chassis through R20, R21 (decoupled by C25) which are in negative HT return lead.

V4 is transformer coupled by OP1 to a 6 $\frac{1}{2}$ in. PM speaker L22. Fixed degree of tone correction is given by C24. Sockets are provided on secondary L14 of OP1 for connection of a low-impedance (3 ohm) extension speaker.

**HT** is provided by an indirectly-heated fullwave rectifier V5 the anode voltages of which are obtained from HT secondary L16 of mains input transformer OP1. Heater current is obtained from L17. Choke-capacity smoothing is given by L15, C26, C27 whilst mains filtering is provided by C29, C30. Reservoir smoothing capacitor C27 is rated to handle 150mA ripple current. Negative side of HT is fed to chassis through R20, R21 decoupled by C25 in order to provide grid bias for V4, delay voltage for AVC diode and standing bias for grids of V1, V2.

**Heaters V1 to V4** and dial lights are parallel connected and obtain their current from secondary L21, one side of which is connected to chassis. Primary L18 of MT1 is tapped for input voltages of 200-210, 220-230, 240-250V, 40-100c/s.

**Universal model** of this receiver differs from the above circuit as follows: Valves used are V1 10C1, V2 10F9, V3 10LD11, V4 10P14, V5 U404.

Heaters are series connected and obtain their current from the mains through a 970 ohm tapped dropper resistor. Rectifier anode is fitted with surge limiter R22.

Output transformer has a separate tertiary winding L19 for connection of extension speaker.

A mains interference filter L20 is also incorporated together with filter capacitor C28. Dial lamps are coupled in series and wired in mains lead to chassis through R21, R20.

Earth socket is isolated from chassis by C2. Reservoir capacitor C27 increased to 32mF.

Mains input is fitted with 1A fuse in each lead and a double-pole ON/OFF switch.

### TRIMMING INSTRUCTIONS

Apply signal as stated below	Tune receiver to	Trim in order stated for maximum output
(1) 420kc/s to g1 of V1 via resistive termination	S/C VC2	Cores, L9, 10, 11, 12.
(2) Adjust dial pointers so that they lie vertically down edges of apertures with gang fully meshed.		
(3) 250kc/s to ae socket via dummy aerial	1200 metres	T6, T3
(4) 1.333mc/s as above	225 metres	T5, T2
(5) 15mc/s as above	20 metres	T4, T1

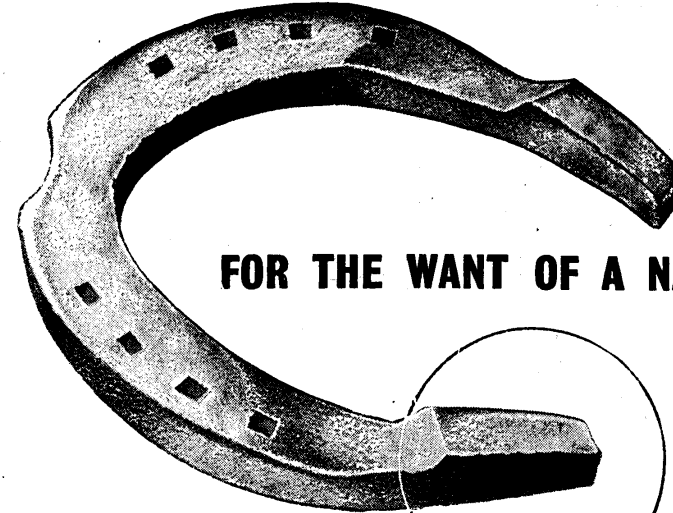

FOR THE WANT OF A NAIL . . .

Dear Mr. Dealer,

Your service Department is good. No doubt, you want it to become better.

Do you know that we offer you the largest range of guaranteed spare parts backed by the finest delivery service this country has ever known!

Do not hesitate—give your orders to our Representative who calls on you. Should you be outside the areas covered by our Sales Force at present, write with full confidence—your smallest needs will receive immediate and business-like attention.

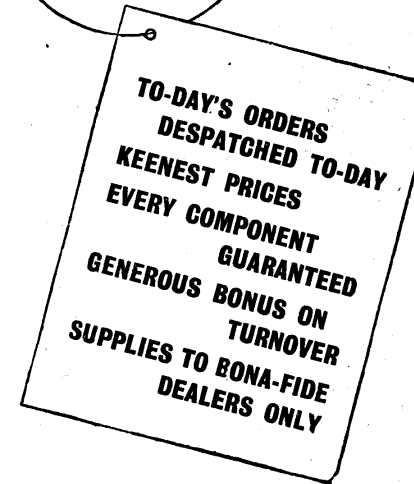

## Radio&spares Ltd.

19-23 FITZROY STREET, LONDON, W.1. Telephone: MUSeum 9301/6  
Telegrams: RADOSPERES, WESDO, LONDON. Cables: RADOSPERES, LONDON