

# HMV MODEL 1604

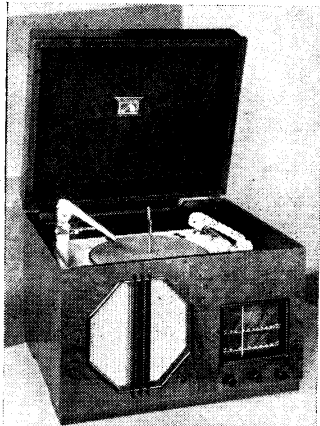
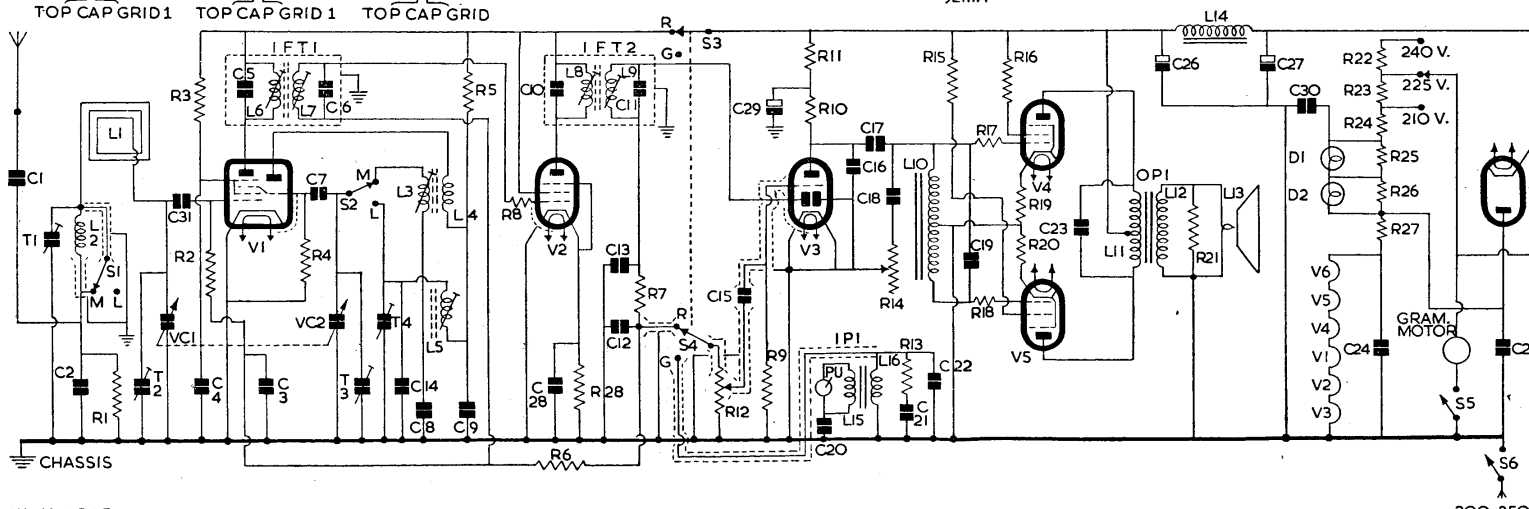
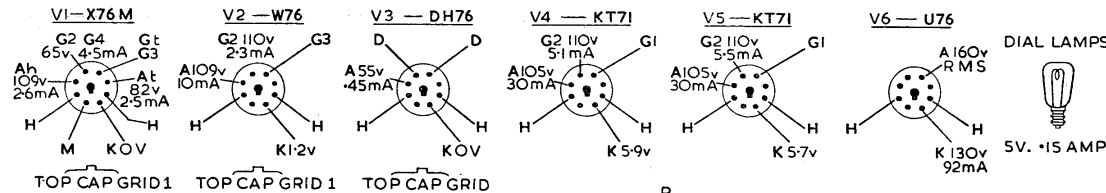

Table model radiogram for 195-255V 50 c/s AC mains. Six-valve two-waveband radio with push-pull output stage. Automatic record changer fitted with lightweight pickup operating with up to ten 10 or 12 in. records at one loading. Walnut veneered table cabinet.



### CAPACITORS

Capacity Type

1	3500 pf silver mica
2	3500 pf "
3	.047 tubular 350 v
4	1 " 350 v
5	80pf silver mica
6	80pf "
7	75pf "
8	350pf "
9	200pf "
10	80pf silver mica
11	80pf "
12	100pf "
13	100pf "
14	75pf silver mica
15	2300pf "
16	230pf "
17	.05 tubular 350 v
18	5000pf silver mica
19	500 "
20	.005 "
21	.005 "
22	500pf "
23	.0023 "
24	.0023 "
25	.05 tubular 500 v
26	32 electrolytic 350 v
27	32 " 350 v
28	.047 tubular 350 v
29	8 electrolytic 200 v
30	.0023 silver mica
31	100pf "

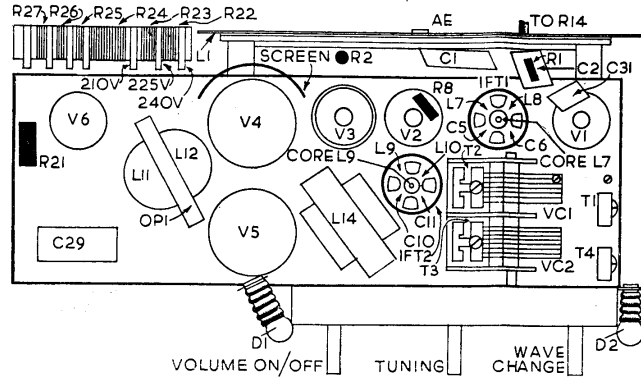

### RESISTORS

R	Ohms	Watts	R	Ohms	Watts	R	Ohms	Watts
1	22 k	1/2 W	11	10 k	1/2 W	20	160	1/2 W
2	470 k	1/2 W	12	500 k	SPST Switch	21	47	1/2 W
3	10 k	1/2 W	13	150 k	Potentiometer	22	60	1/2 W
4	100 k	1/2 W	14	500 k	Potentiometer	23	60	1/2 W
5	10 k	1/2 W	15	500 k	Potentiometer	24	160	1/2 W
6	1.5 m	1/2 W	16	160	1/2 W	25	35	1/2 W
7	47 k	1/2 W	17	10 k	1/2 W	26	35	1/2 W
8	4.7 k	1/2 W	18	10 k	1/2 W	27	65	1/2 W
9	10 m	1/2 W	19	160	1/2 W	28	100	1/2 W
10	100 k	1/2 W						

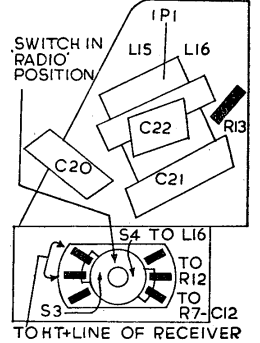
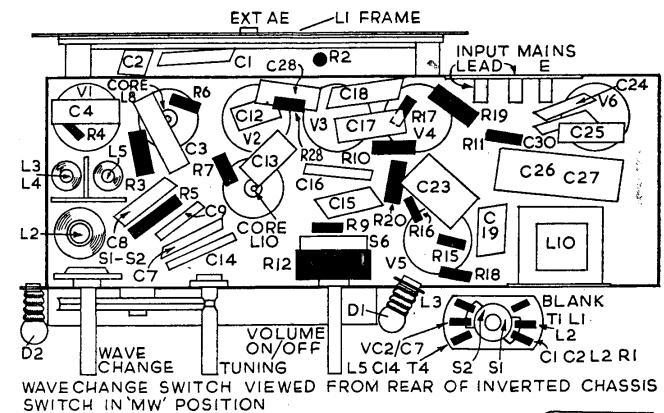
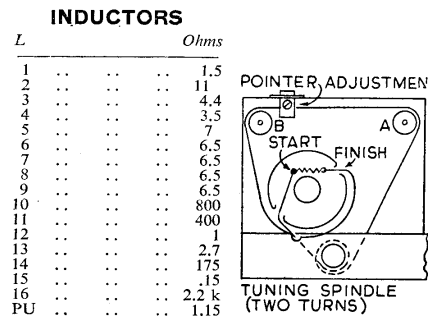

## HMV MODEL 1604—Continued

**RECEIVER CIRCUIT** consists of triode-hexode frequency changer V1 coupled by permeability-tuned IF transformer to a variable- $\mu$  pentode IF amplifier V2. A second permeability-tuned transformer leads to double-diode triode V3, used for signal rectification, AVC and AF amplification. Centre-tapped choke energises grids of push-pull output valves V4, V5, which feed a 6 $\frac{1}{2}$  in. PM speaker. The pickup is coupled through a matching and step-up transformer, and via the radiogram switch, to the volume control in the receiver. HT is provided by a half-wave indirectly heated rectifier V5.

**Aerial circuit.** An internal frame aerial L1 is tuned by VC1 and trimmed by T2 on MW. On LW, loading coil L2 is switched in series with earthy end of L1 by S1. L1 and L2 are then tuned by VC1 and trimmed by T1. Aerial tuned circuit is coupled to g1 of V1 through C31. Provision is made for connection of an external aerial through C1 to bottom end of L2 or L1. C2 and R1 are bottom end coupling.

AVC is applied to g1 of V1 through R2 and decoupled by C3. Screen (g2, g4) voltage is obtained from R3 decoupled by C4. L6, C5, the primary of IFT1, is in the hexode anode circuit.

**Oscillator** is connected in a tuned grid circuit. L3 the MW coil and L5 the LW tuned coil are switched by S2 to tuning capacitor VC2 and, through C7, to oscillator grid (gt, g3). T3 is MW trimmer and C8 MW padder. T4, C14 are LW trimming and C9 is padding. R4, C7 provide leak-condenser bias.

Anode reaction is developed inductively from L4 on MW band; on LW, however, it is obtained across the padding capacitor C9. R5 is oscillator anode load resistor.

**IF amplifier** operates at 465 kc/s. L7, C6, the secondary of IFT1, feeds the signal to g1 of V2, the variable- $\mu$  amplifier. AVC is fed to g1 from R6, through secondary winding L6. C3 is AVC decoupling and R8 a grid stopper. Screen (g2) voltage is obtained direct from HT line. Cathode bias is by R28 and C28. L8, C10, form the primary of IFT2.

**Signal rectifier.** L9, C11, secondary of IFT2, feeds signal to one diode of V3. R12, the volume control, is the diode load resistor and R7, C12, C13 form an IF filter. R12 is connected to R7 when S4 is in the Radio position. In Gram. position of S4, the pickup transformer secondary L16 is connected across R12.

**Automatic volume control** is obtained from the signal diode and is fed through R6 to g1 of V1 and V2. C3 is AVC line decoupling capacitor.

**Pickup** is of the low-impedance type and a step-up transformer IP1, L15, L16, couples it to the receiver. A connecting network R13, C21, C22 is across L16. One side of the pickup is connected to the metal chassis of the motorboard which is directly earthed. The receiver, being an AC-DC type, is earthed to the motorboard chassis through isolating capacitor C20.

Output from secondary of IP1 is fed to S4, which in the Gram. position, switches it to R12, the volume control. S3, ganged to S4, breaks the HT supply to anodes and screens of V1 and V2 when in the Gram. position.

**AF amplifier.** C15 feeds either radio or pickup signals developed across R12 to grid of triode section of V3. Bias for grid is developed on C15 with R9 as grid leak. R10 is anode load

resistor and C16 anode RF bypass capacitor. R11, C29 provide decoupling of HT supply to anode.

**Output stage.** C17 feeds signal to auto-transformer L10, the centre tap of which is earthed. The opposite phase signals appearing across each half are applied to grids (g1) of push-pull output pentode valves V4 and V5 through grid stopper resistors R17 and R18. C19 is shunted across L10, and C18, R14 provide adjustable top cut tone control. Each output valve has its own cathode bias resistor—R19 for V4 and R20 for V5. No decoupling is provided, hence a degree of negative feedback is applied.

Screens (g2) obtain voltage from HT line through stoppers R15, R16. HT for anodes is fed to centre tap of primary L11 of output matching transformer OPI. C23 gives fixed tone correction.

L12, secondary of OPI, feeds a 6 $\frac{1}{2}$  in. PM loudspeaker L13. R21 across L12 prevents damage to output valves and OPI in the event of the LS becoming disconnected.

**High tension** is provided by a half-wave indirectly heated rectifier V6. Its anode voltage is obtained through section of mains dropper resistor R22-R27. L14, C26, C27 provide choke-capacity smoothing and C24, C25, C30 are filter capacitors.

**Heaters of V1 to V6** are series connected and obtain their current through mains dropper resistor R22-R27. The two dial lamps are shunted across R25 and R26 of this resistor. S6, which is connected in the mains lead to chassis, is the on/off switch for both receiver and turntable motor. S5, which is mounted on the turntable chassis and is coupled to the auto-changer mechanism, is the motor on/off switch.

**Dismantling.** For replacement of valves dial lights and minor adjustments and alignment, the receiver chassis need not be removed from the cabinet. The auto-changer plate and panel on bottom of cabinet must be removed as follows:—

Set record retaining arm down and secure the pickup arm to its rest. Remove rear panel of cabinet and unfasten aerial and earth bracket and cleat from baseboard. Remove aerial plug from socket in centre of receiver frame aerial.

Remove the two motor leads (blue) from the "Motor" tags on panel on receiver chassis. Remove four large screws at corners of auto-changer plate. Lift front of plate by means of the pickup rest and record support pedestal and remove five pin plug from sub-panel just under the radiogram switch. The auto-changer plate is now free to be withdrawn from cabinet.

No provision is made on the plate for resting it on the bench. Place auto-changer plate in vertical position on bench (with record support pedestal edge of panel resting on bench surface) and insert suitable wood block under lifting handle and also under end frame of motor. The record retaining arm or pedestal should on no account be allowed to take any of the weight of the plate.

Connect pin 1 to pin 2 and pin 4 to pin 5 on plug on receiver lead. Receiver can now be operated in the normal way for testing.

**Removal of chassis.** Remove the three push-on knobs, the mains dropper resistor and three cable

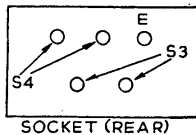
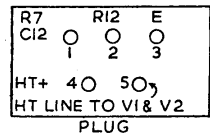

## Insulation+Continuity with one instrument

The Everett Edgcombe Hum-Metrohm Insulation Tester is an instrument with three positive advantages.

1. It can be operated with one hand, leaving the other free to manipulate the connections.
2. Combines a 500 volt insulation and earth circuit conductivity test in a single instrument.
3. Ripple-free testing current facilitates insulation measurements on condensers.

Both regular and occasional users of insulation testing sets will find these three advantages of real value.

Full details gladly sent on request. Ask for catalogue sheet 242F.

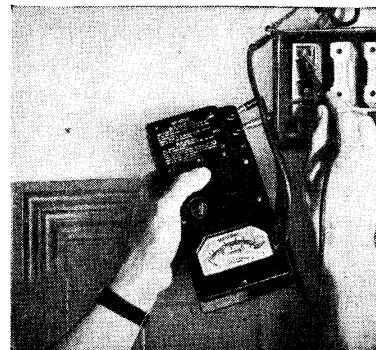

### THE HUM-METROHM

MAKERS OF ELECTRICAL INSTRUMENTS FOR INDICATING, RECORDING AND CONTROLLING, PHOTOMETRIC APPARATUS AND PROCESS CONTROLS.

COLINDALE WORKS, LONDON, N.W.9  
Tel.: COLindale 6045



"Just horrible howls in the night There's spooks in that manor all right." Cried EH, "Oh dear, no. That's a dud radio. Watch FLUXITE soon put 'em to flight!"

For all **SOLDERING** work you need **FLUXITE**—the pasteflux—with which even dirty metals are soldered and "tinned." For the jointing of lead—without solder and the "running" of white metal bearings—without "tinning" the bearing. It is suitable for **ALL METALS**—excepting Aluminium—and can be used with safety on Electrical and other sensitive apparatus. With **FLUXITE**, joints can be "wiped" successfully that are impossible by any other method. **OF ALL IRONMONGERS**, in tins—10d., 1/6 & 3/- Used for over 40 years in Government works and by leading Engineers and Manufacturers. The "FLUXITE GUN" puts Fluxite where you want it by a simple pressure. Price 1/6 or filled 2/6.

## FLUXITE

SIMPLIFIES ALL SOLDERING

Write for Leaflets on Case-Hardening Steel and Tempering Tools with FLUXITE, also on "wiped" joints. Price 1d. each. FLUXITE LTD. (Dept. T.E.), Bermondsey St., London, S.E.1.

# STURDY FOR REWINDS

Send your rewinds to Sturdy. All makes Radio Mains Transformers, Field Coils, etc. First-class work with quick delivery and fully guaranteed.

**STURDY ELECTRIC CO., LTD.**  
DIPTON Tel.: DIPTON 221 NEWCASTLE-ON-TYNE

## HMV MODEL 1604—Continued

cleats. Pull off tone-control knob and remove tone control and bracket from side of case. Remove insulating caps covering the four chassis bolts and unscrew bolts. Withdraw chassis.

**Replacement of cord drive.** Approximately 28 inches of high grade flax fishing line is required. Form a loop of  $\frac{1}{8}$  in. diameter at one end. Pass loop through hole in periphery of drum and fix to anchor pin. Take cord partly round drum and wind round tuning spindle two complete turns.

Take cord over pulley A and pulley B and partly round drum and in through hole in periphery. Attach to tension spring and shellac start and finish knots on cord. Attach cursor to cord and adjust position of pointer to read correctly on known frequency.

### TRIMMING INSTRUCTIONS

Apply signal as stated below	Tune receiver to	Trim in order stated for max. output
1) 465 kc/s to top cap V1 via .05 capacitor	Gang cond. to max.	Cores L9, L8, L7, L6
2) Check that with the centre of dial on calibration scale	gang condenser at rear top of	ser at maximum cides with 5 inches dial plate
3) 1.667 mc/s to AE socket via dummy aerial	Gang cond. to min.	T3
4) 1.429 mc/s as above	Cursor to 129/32 in.	T2
5) 588 kc/s as above	Cursor to 4 13/32 in.	CORE L3—REPEAT (3) (4) and (5)
6) 333.3 kc/s as above	Gang cond. to min.	T4
7) 300 kc/s as above	Cursor to 2 1/4 in.	T1
8) 162.5 kc/s as above	Cursor to 4 13/32 in.	CORE L5—REPEAT (6) (7) and (8).
9) After chassis has been replaced in cabinet check calibration at about middle of scale on frequency. Adjust dial cursor to give best compromise on both wavebands.		

### THE AUTOMATIC RECORD CHANGER OPERATING SEQUENCE

In the following description the figure in each part number refers to the appropriate Figure, thus 7D is found in Fig. 7.

**1. Automatic starting of gear assembly.** On pressing the "Auto" button, the last-record lever 7D auto-lever assembly 7E and reject lever 7F, are drawn across the mechanism plate by means of the rocker 7B. 7E is retained in its "on" position by the latch on the latch assembly 7AD, spring 7AE holding the latch in. Switch-plate assembly 7L, attached to 7E, switches on the mains supply to the motor, which drives the turntable and the assembly 5K through the pulleys.

7F performs no function at this stage. 7D operating the last-record connecting-link assembly

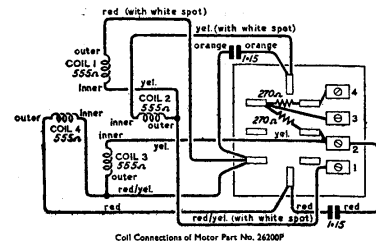

Fig. 2

7AP allows the last-record plunger 6L to drop and retain 7AP and 7D against spring 7J.

At the same time, the stud on 7E moves the lever-operating clutch plate 7AC. The latter turns the clutch plate 7AA, which pushes the clutch-operating lever assembly 7Z to its furthest position, also drawing the lever-operating clutch gear assembly 7X from the gear and clutch assembly 7AL. 7AL drops and engages with pinion 7AM which drives the gear assembly, which operates in the following sequence.

**2. Dropping a record.** The cam follower plate assembly 5B, spring loaded by 5Q, follows the cam on the underside of the cam gear assembly 5C. By means of the lever and connecting link assembly 5P and clamp block 5L, the pusher tube 3A

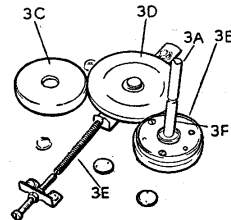

Fig. 3

revolves so that the shaped end of the tube draws the record directly over the spindle allowing it to drop on the turntable. The records remaining on the cranked spindle, depress 3A against spring 5M so that the top of the shaped end of 3A becomes flush with the "shelf" of the cranked spindle.

**3. Feeding pickup on to record.** The pickup lifting rod 4B, engaging on the top of the vertical cam on 5C raises the pickup. The cam follower plate assembly 8H, following the horizontal cam on 5C allows spring 8E to draw the pickup towards the record; the cam gear lever 5D, spring loaded by 5E, ensures gentle movement of the pickup.

The position at which the pickup lands on the record, is determined by the pickup control lever 8D coming into contact with the appropriate stop, i.e., for 12-inch records the stud on the stop plate 7AT is used, and the position of this plate is adjusted by means of the 12-inch PU control adjuster, A 4D locked by 4C; for 10-inch records, the 10-inch PU control adjuster, B 4D locked by 4C itself is used. 7AT is brought into operation by lifting the 10-inch record support 6B, the movement of which is transmitted to 7AT via the 12-inch pickup control connecting link 7AR; 7AR being loaded by spring 7AS.

**4. Teasing pickup into music grooves.** The pickup is lowered on to the record by the same cam on 5C and is teased into the first groove by the

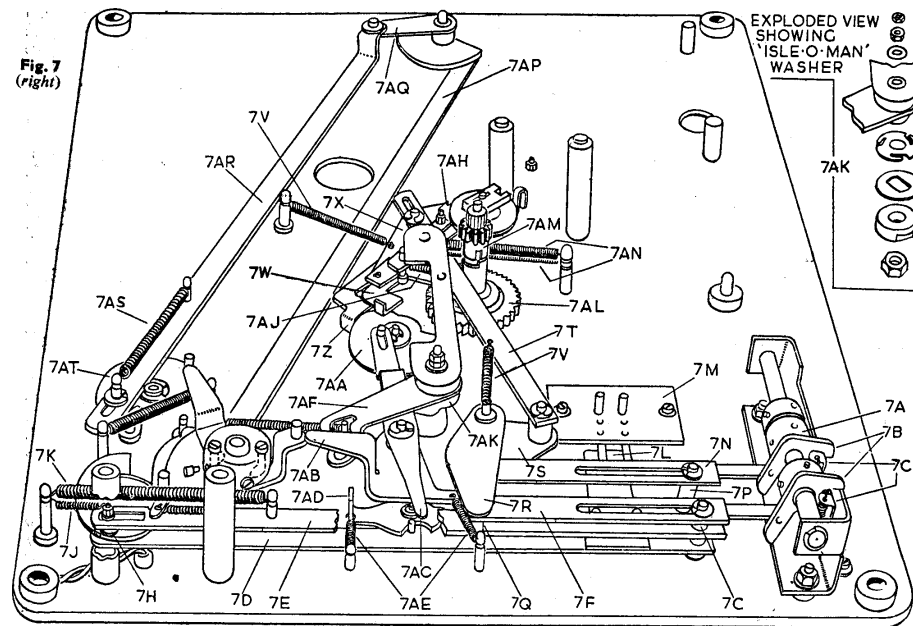

projection on the upper face of the horizontal cam on 5C bearing on the pickup feed-in lever 8L; this movement is transmitted to the pickup via the pick-up lever operating trip mechanism 8J by the spring 8K. The tension of 8K is sufficient to draw the needle into the first groove, but not too strong to drag it beyond; the remaining movement of the projection simply pushes 8L to one side.

**5. Automatic stopping of gear assembly.** At this stage the clutch operating lever 7W is drawn into the cut-away section of the clutch on the gear and clutch plate assembly 5F by spring 7AN (lower),

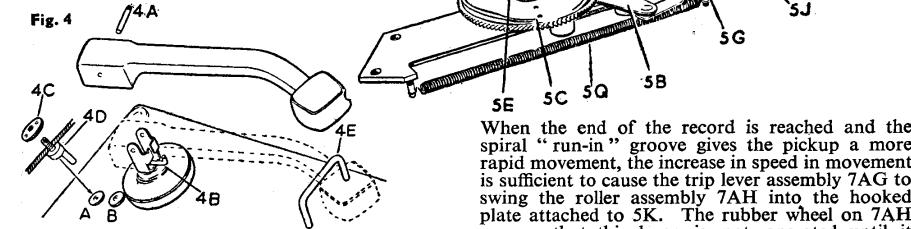

drawing with it 7X which engages on the cam on the underside of 7AL. Check-spring 7Y prevents 7W "bouncing" (at the end of its travel) against the trip lever assembly 7AH and causing the mechanism to trip as the pickup enters the music grooves. 7AL thus lifts and disengages from 7AM. The gear assembly now ceases to operate.

**6. Playing of record and operation of "Isle of Man" washer.** The pickup travels across the record at its normal rate and the trip lever quadrant 7AF to which is attached the "Isle of Man" washer 7AK, is moved slowly and constantly by means of 8J.

When the end of the record is reached and the spiral "run-in" groove gives the pickup a more rapid movement, the increase in speed in movement is sufficient to cause the trip lever assembly 7AG to swing the roller assembly 7AH to the hooked plate attached to 5K. The rubber wheel on 7AH ensures that this lever is not operated until it receives the rapid movement from the spiral "run-in" groove; the rubber wheel coming into contact with a projection on the hooked plate of 5K. The hooked plate engaging on 7AH forces it away, pushing 7W away from the clutch on 5F and withdraws 7X from 7AL, which then drops and engages 7AM. As 7W is pushed away from the clutch of 5F, the spring loaded plate closes (by spring 5H) so that 7W is held on the periphery of the clutch when it returns, thereby ensuring that 7X does not re-engage on 7AL. The gear assembly commences to operate again. 7AG is returned to

## HMV MODEL 1604—Continued

its normal position by a stud on the underside of 5F.

So that the "Isle of Man" washer is being fed in (Section 3), a stud on 7AG comes into contact with the clutch gear plate 5G.

**7. Returning pickup to rest.** The pickup lifting rod 4B engaging on the top of the second vertical cam on 5C raises the pickup. 8H, engaging on the horizontal cam on 5C, forces the pickup to a position over its rest. The pickup is lowered on to its rest by 4B following the cam. While the pickup is being returned to its rest, the pusher tube 3A is rotated by 5B, spring loaded by 5Q, bearing on the cam on the underside of 5C, and locates in the next record by the action of spring 5M.

This complete cycle (sections 2-7) for playing one record is repeated until last record is dropped.

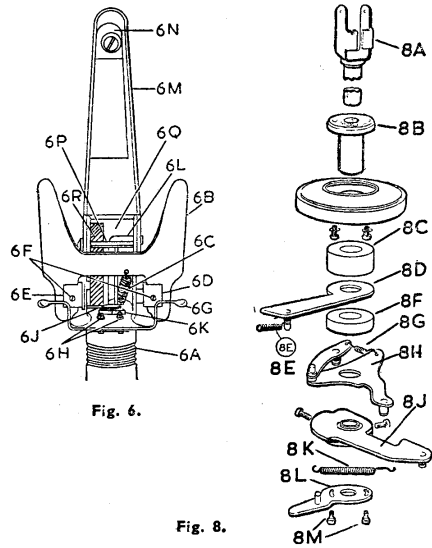

Fig. 6.

Fig. 8.

**8. Dropping and playing last record.** When the last record has dropped on to the turntable the record retaining arm 6M falls to the furthest length of its travel and in doing so raises the last record plunger 6L. As soon as 6L is withdrawn, 7AP and 7D are released, both adopting their original positions by the action of spring 7J. This movement of 7D causes the latch on 7AD to be withdrawn from the cut-away in 7E. 7E is withdrawn by spring 7K until it is held by the latch on the switch lever assembly 7AB, which is itself retained by the second spring 7AE.

The pickup is fed on to and plays the record in the method described in Sections 3 and 4.

**9. Automatic switching off.** At the end of the record the "Isle of Man" washer operates moving 7W and 7X as described above, 7AL engaging once again with 7AM. The pickup is returned to its rest in the normal way. At the same time the projection on the upper face of the horizontal cam on 5C strikes 7AB, releasing the latch holding 7E, thus allowing spring 7K to return 7E to its normal position. In doing so a stud on 7E moves 7AC,

which in turn rotates 7AA, allowing 7Z to be drawn in by spring 7AN, thus permitting 7X to disengage 7AL from 7AM. At the same time the switch plate assembly 7L disconnects the supply to the motor.

**10. To reject a record.** A record can only be rejected after it has started to be played. The "Auto" button is pressed and the movement of 7F is transmitted via the auto reject lever plate 7R and the reject lever and clutch 7T to 7W, which is thereby pushed away from the clutch on 5F. Lever 7X is withdrawn, allowing 7AL to engage with 7AM. The spring loaded plate closes, by spring 5H, so that 7W rests on the periphery of 5F. The sequence of operations for returning the pickup to its rest, dropping the next record and feeding the pickup in are described in Sections 7, 2, 3 and 4.

**11. Pressing the "off" button.** On pressing the "off" button, which must be done only when the pickup is on the record, the off lever 7N is drawn across the mechanism plate by means of the rocker 7B. This movement of 7N is transmitted via the off reject lever plate 7S and the reject lever and clutch connecting link 7T to 7W. 7X is withdrawn and 7AL engages with 7AM. A stud on 7S withdraws 7AD, thus allowing 7E to be retained by the latch on 7AB. The pickup is returned to its rest and at the same time the latch on 7AB is released by the action of the projection on top of the horizontal cam on 5C. The movement of 7E returns all levers to their normal positions and switches off the supply to the motor.

**12. Safety clutch for pickup.** If the pickup is inadvertently knocked inwards towards the centre spindle, the safety clutch comes into operation to prevent damage to the pickup or its mechanism. The smaller lever of 8H, which is normally retained by spring 8G in the cut-away in 8J, is disengaged. To reset, the pickup is swung back until this stud re-engages in 8J.

### MAINTENANCE

In the event of faulty behaviour, the instrument should be watched carefully to ascertain at what point trouble occurs. Do not use force when making adjustments and do not attempt to retard or hurry the pickup arm during the changing cycle—serious damage may result.

Two test records, TB11 and TC14, are available to facilitate the adjustment of this mechanism.

**To adjust pickup landing position.** With either TB11 or TC14 test record on the turntable, the needle must descend on the appropriate modulated groove for 10 or 12 in. records. Should the pickup lower at the wrong point in either case, disconnect the supply and adjust as follows:

With a 10 in. test record on the turntable, lower the record retaining arm and lower the 10 in. record support plate. Press "Auto" button, rotate turntable by hand until the pickup arm reaches its maximum inward travel. Continue to rotate the turntable until the pickup is within about  $\frac{1}{4}$  in. of the surface of the record. Slacken locking nut 4C of the 10 in. PU control adjuster B on top of the mechanism plate and rotate slightly the eccentric pin 4D until the needle adopts the desired position. Secure the adjustment by retightening the locking nut.

With a 12 in. record, repeat the above operations, but with the 10 in. record support plate raised, and adjust by means of A.

**To adjust pusher tube** so that mechanism drops records correctly. Slacken screw in clamp block 5L. With cranked spindle in position, rotate pusher tube 3A, until its shaped end sits directly beneath the upper portion of the cranked spindle. Raise

## HMV MODEL 1604—Continued

3A until the upper edge of the tube is flush with the "shelf" in the cranked spindle. A gap of approximately  $\frac{3}{32}$  in. between the lower edge of tube 3A and top of the sleeve 3F should result. Re-tighten screw in 5L.

**To adjust record support plates.** For 10 in.: Remove cranked spindle and lower 10 in. record support plate 6B. Hold a 10 in. record horizontally so that the pusher tube 3A just passes through the centre hole. Slacken fixing screws 6F and adjust until a clearance of  $\frac{1}{16}$  in. is obtained between 6B and the edge of the record. Re-tighten screws 6F.

For 12 in.: Remove the cranked spindle and raise fully the 10 in. record support plate 6B. Using a 12 in. record repeat as for 10 in. record, adjusting the 12 in. record support plate 6G by slackening screws 6H.

**To adjust "Isle of Man" washer.** Over a long period the setting of the friction washer may need adjusting. This can be obtained by tightening the adjustment nut (approximately a quarter turn at a time) and securing by means of the locking nut.

**To adjust plate on clutch operating lever 7W.** With the rubber wheel of the roller assembly 7AH resting against the projection of the hooked plate 5K, adjust the plate on clutch operating lever 7W until there is a  $\frac{1}{8}$  in. gap between the edge of the plate and the stud on 7AH.

[Test records TB11 and TC14 and special tools Q/D 514/4, for removing the mechanism and adjusting the PU control adjuster are available from the manufacturers.]

### MOTOR

The motor is an hysteresis synchronous type designed to operate on 200-250V 50 c/s AC mains. The speed of rotation of the turntable is maintained at 78 r/m.

**Principle.** The hysteresis motor is an induction type operating by virtue of the rotating magnetic field produced by the four-pole stator in conjunction with condensers. The rotor consists of a plain ring of magnet steel which, during starting, is magnetised by the eddy currents produced by the rotating field in such a way that torque is developed between the stator and the rotor field. As the motor reaches synchronous speed the rotor becomes polarized in a simple two-pole manner and consequently follows the rotating field set up by the stator.

**Removal of motor.** Remove the turntable (3 screws). Detach mains lead (blue) from the tag panel, and earth tag and cleat from underside of motor. Slacken off the grub screw on motor pulley 3C. Take out the three screws on top of the mechanism plate, at the same time supporting the bottom of the motor to prevent it from dropping. Withdraw the motor.

**Removal of stator.** Remove large bronze rotor bearing, and withdraw rotor carefully. Unsolder leads from condenser block. Remove stator assembly by unscrewing the four securing screws.

When re-assembling, care must be exercised to ensure that the end of the rotor spindle is located in the spring loaded bearing (at the worm end) before pushing the large bronze bearing home. Before finally tightening the stator securing screws assemble the rotor in position and ensure that an equal gap is obtained all round the magnet steel ring. A diagram of the coil connections is given in Fig. 2.

**Removal of main spindle.** Remove three screws securing the bottom plate of the motor. Spindle can now be withdrawn.

**Adjustments.** End play is catered for by the spring loaded bearing. Ball thrust bearings should be present at both ends of the rotor and at the lower end of the turntable spindle.

Motor should be oiled periodically with a fine machine oil. There are three lubrication points—two holes at extreme ends of motor, and the spindle bearing.