

INVICTA MONOMATIC A.C. FIVE

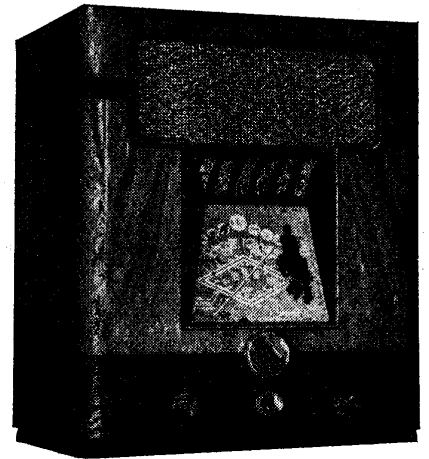

The Invicta model 500 incorporates Monomatic rotary knob auto tuning.

CIRCUIT.—The aerial coupling to the grid of V1, a triode hexode frequency changer is *via* selectively switched H.F. aerial transformers. The medium wave aerial transformer has further coupling in the form of C3. The oscillator section of the valve conforms with standard practice, the oscillator anode being coupled to the reaction windings *via* the coupling condenser C18. It will be noted with regard to the pre-set station arrangement that the aerial and oscillator sections are automatically switched to the correct waveband and are pre-tuned by means of separate sets of trimmers for each station.

Coupling to the I.F. amplifying valve V2, an H.F. pentode, is effected by means of an I.F. transformer tuned to 465 kc. The I.F. transformers are of the non-trimmer type, to prevent drift.

A further I.F. transformer of similar construction provides the coupling between the I.F. amplifier and the demodulating diode and load of V3, a double diode triode. The

other diode provides the D.C. potential for the A.V.C. network to V1 and V2. The demodulating diode load consists of two resistances, the centre point being connected to the visual tuning indicator *via* a decoupling circuit.

A feature is that the coupling arrangements to the grid of the triode section of V3 include a tone compensated manual volume control and a three-position tone switch.

RESISTANCES

| R. | Purpose. | Ohms. |
|----|---------------------------------|------------|
| 1 | V1 screen decoupling | 20,000 |
| 2 | Osc. anode load | 20,000 |
| 3 | Osc. grid leak | 20,000 |
| 4 | V1 cathode bias | 300 |
| 5 | T.I. anode feed | 2 megohm s |
| 6 | V2 cathode bias | 450 |
| 7 | V3 anode decoupling | 40,000 |
| 8 | V3 anode load | 60,000 |
| 9 | Tone control | 250,000 |
| 10 | H.F. stopper | 100,000 |
| 11 | Demodulating diode load (part). | 250,000 |
| 12 | Volume control | 1 megohm. |
| 13 | T.I. grid decoupling | 250,000 |
| 14 | Demodulating diode load (part). | 250,000 |
| 15 | Tone modifier | 60,000 |
| 16 | A.V.C. line decoupling | 1 megohm |
| 17 | A.V.C. diode load | 1 megohm |
| 18 | V3 cathode bias | 1,000 |
| 19 | V4 cathode bias | 150 |
| 20 | V4 grid leak | 500,000 |
| 21 | V4 grid stopper | 100,000 |

VALVE READINGS

No signal. Volume maximum. M.W. band minimum capacity. 200 volt A.C. mains.

| V. | Type. | Electrode. | Volts. | Ma' |
|----|---------------|------------|--------|-----|
| 1 | TH4A (7 met). | Anode | 198 | 3.1 |
| | | Screen | 110 | 4 |
| | | Osc. anode | 92 | 4.1 |
| 2 | VP4B (7 met). | Anode | 198 | 6.5 |
| | | Screen | 200 | 2.2 |
| 3 | TDD4 (7 met). | Anode | 55 | 1.4 |
| 4 | Pen. A4 (7) | Anode | 185 | 25 |
| | | Screen | 200 | 4 |
| | | Cathode | 300 | — |
| 5 | IW4/350 (5). | | | |

QUICK TESTS

Quick tests are available on the field winding on speaker and across the output transformer primary. Volts measured between these and the chassis should be—

Output transformer—185 and 200 volts, smoothed H.T.

Field—300 volts, unsmoothed H.T.
200 volts, smoothed H.T.

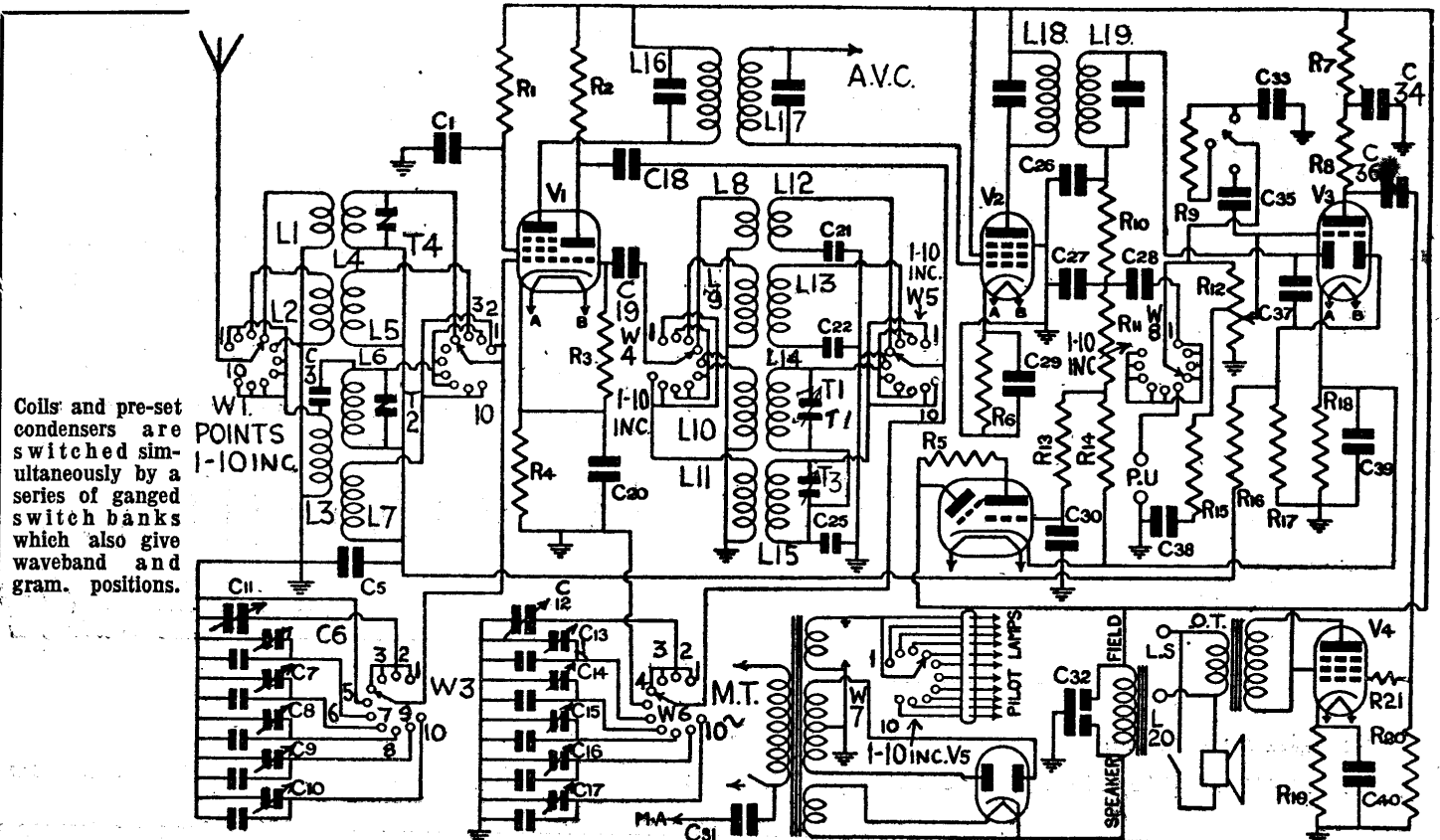

Coils and pre-set condensers are switched simultaneously by a series of ganged switch banks which also give waveband and gram. positions.

V3 is resistance capacity coupled to V4, an output pentode and the last stage in the radio line-up.

Mains equipment consist of a mains transformer, a full-wave rectifying valve, V5, electrolytic smoothing condensers, and a smoothing choke (the speaker field).

Chassis Removal.—The cabinet has a false bottom secured by four wood screws, removal of which enables the underside of the chassis to be exposed and access to be obtained to all trimmers.

Remove the four spring fixed control knobs from the front of the cabinet. Then turn the cabinet on its side and remove the four chassis securing bolts and washers from the base, afterwards returning the cabinet to its original upright position.

The chassis may then be removed from the cabinet free to the extent of the speaker leads and is fully accessible from the point of view of service work.

If desired the speaker (secured by four nuts) may be removed, and the chassis operated externally of the cabinet.

Special Notes.—A Q.M.B. switch at the rear of the chassis enables control of the internal speaker to be obtained. Connections to an extension speaker with an im-

pedance of two ohms can be plugged into the L.S. sockets at the rear of the chassis.

Pick-up sockets are provided. A wander plug at the rear of the chassis near the aerial socket can be plugged into the aerial socket when the mains wiring can be used as an aerial.

The mains voltage adjustment on the mains transformer takes the form of three sockets marked with voltage values. A flying lead makes the contact with the desired tapping.

Pilot lights, of which there are 12, are rated at 6.2 volts .3 amp. and are of the 15 mm. M.E.S. base type. These fit into screw-in holders clipped to various portions of the wavelength dial assembly.

The visual tuning indicator and holder can be removed from its mounting by a slight pull. R5 is connected across the visual tuning indicator valve holder. The tuning indicator is a Mullard type T.V.4.

C3 is formed of insulated wires twisted together.

(Continued on page viii.)

Invicta 500 on Test

MODEL 500.—Standard model for A.C. mains operation, 200-250 volts, 40-100 cycles. PRICE.—£13 19s. 6d.

DESCRIPTION.—A four-valve, plus rectifier, four-waveband table superhet.

FEATURES.—Full-vision scale calibrated in metres and station names. Selector switch gives choice of five stations automatically tuned. Station names (pre-set) light up when switched to same. Selector switch also controls waveband. Other controls for combined volume and master switch, flywheel manual tuning and tone switch. Sockets for P.U. and E.S. with Q.M.B. switch at rear of chassis controlling internal speaker. Provision for mains aerial.

LOADING.—75 watts.

Sensitivity and Selectivity

SHORT WAVES (13.5-52 and 50-200 metres).—Good gain selectivity well maintained on both bands. Easy handling and no drift.

MEDIUM WAVES (200-500 metres).—Representative gain and selectivity, with a good background. Local station spread on adjacent channels.

LONG WAVES (800-2,100 metres).—Good sensitivity and selectivity. All main stations easily received, some overlap on Deutschland-sender.

Acoustic Output

Well-balanced output with sufficient volume for ordinary room. Top crisp and clean, and good low-note radiation. Speech natural.

AUTOMATIC TUNING.—The pre-set adjustments for the five stations were found to be correct and did not change during the period of test.

CONDENSERS

| C. | Purpose. | Mfds. |
|----|----------------------------------|---------|
| 1 | V1 screen decoupling | .1 |
| 3 | M.W. aerial coupling | .000006 |
| 5 | V1 A.V.C. decoupling | .1 |
| 18 | Osc. anode coupling | .00015 |
| 19 | Osc. grid | .00015 |
| 20 | V1 cathode bias shunt | .1 |
| 21 | B1 osc. fixed padder | .005 |
| 22 | B2 osc. fixed padder | .0013 |
| 25 | M.W. and L.W. osc. fixed padder. | .000657 |
| 26 | H.F. bypass | .00015 |
| 27 | H.F. bypass | .00015 |
| 28 | L.F. coupling | .05 |
| 29 | V2 cathode bias shunt | .1 |
| 30 | T.I. grid decoupling | .1 |
| 31 | Mains aerial coupling | .001 |
| 32 | H.T. smoothing | 8+8 |
| 33 | Tone control | .001 |
| 34 | V3 anode decoupling | .1 |
| 35 | Tone control | .00002 |
| 36 | L.F. coupling | .05 |
| 37 | A.V.C. diode coupling | .00015 |
| 38 | Tone modifier | .005 |
| 39 | V3 cathode bias shunt | .20 |
| 40 | V4 cathode bias shunt | .20 |

WINDINGS (D.C. Resistances)

| L. | Ohms. | Range | Where Measured. |
|------------|-----------|-------|------------------------------|
| 1 | .5 | B1 | Aerial socket and chassis. |
| 2 | .9 | B2 | Aerial socket and chassis. |
| 3 | 70 | M.W. | Aerial socket and chassis. |
| 4 | Very low. | B1 | Top grid V1 and R16. |
| 5 | .6 | B2 | Top grid V1 and R16. |
| 6 | 2.8 | M.W. | Top grid V1 and R16. |
| 7 | 14.3 | L.W. | Top grid V1 and R16. |
| 8 | 46.8 | B1 | C19 and chassis. |
| 9 | 85 | B2 | C19 and chassis. |
| 10 | 13 | M.W. | C19 and chassis. |
| 11 | 19.4 | L.W. | C19 and chassis. |
| 12 | Very low. | B1 | C18 and C21. |
| 13 | .5 | B2 | C18 and C22. |
| 14 | 1.7 | M.W. | C18 and C25. |
| 15 | 2.2 | L.W. | C18 and C25. |
| 16 | 7 | Any | Across tags. |
| 17 | 7.3 | Any | Across tags. |
| 18 | 7.3 | Any | Across tags. |
| 19 | 7 | Any | Across tags. |
| 20 | 2,500 | Any | Outside tags, speaker panel. |
| O.T. prim. | 370 | Any | Tags on speaker panel. |
| M.T. prim | 52 | Any | Across mains plug pins |
| total. | | | |

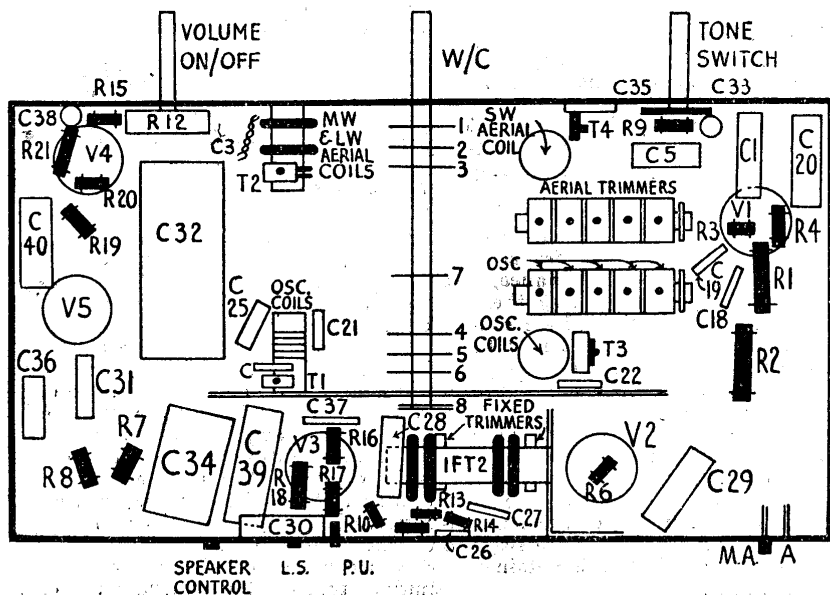

Left, the layout of the underside. Top view is on page viii. The switch banks are similar, the drawing (right) shows them as seen with the chassis on transformer end. Dial lights and corresponding trimmers are shown below.

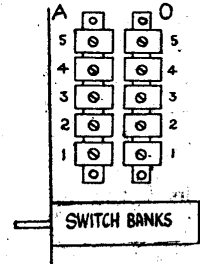
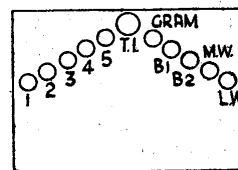
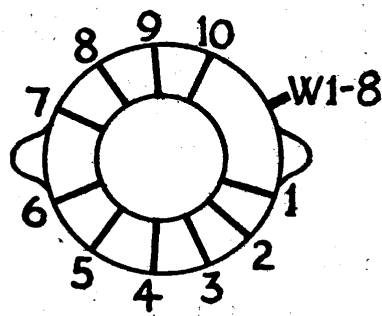

Invicta 500 Monomatic Alignment Notes

(Continued from page iii.)

I.F. Circuits.—As there are no trimmers to drift it should not be found necessary to touch the I.F. transformers. However, should an I.F. transformer be found faulty and need replacing, the following procedure should be carried out.

Connect an output meter across the primary of the speaker transformer. Switch the receiver to the M.W. band, turn gang and volume to maximum and the tone switch to the high position.

Connect a service oscillator between the top grid cap of V1 and chassis. Tune the service oscillator to 465 kc. and vary the coupling between the coils of the transformers (adjusting the outer coils only), until the maximum peak is obtained. Reduce the input from the service oscillator as the circuits come into line to render the A.V.C. inoperative.

Then reseal the coils to the formers with coil dope and allow to dry before carrying out any signal circuit adjustments.

Signal Circuits.—Connect the service oscillator to the aerial and earth sockets via a dummy aerial, only feeding sufficient input to obtain reliable peaks in the output meter, and progressively reducing the input as the circuits come into line.

Turn gang to maximum and set pointer exactly on the 51 and 200 metres calibration marks.

Medium Waves.—Tune set and oscillator to 250 metres (1,200 kc.), and adjust T1 and then T2 for maximum.

The padding is fixed, but check calibration throughout the range covered compensating with T1 if very much out.

Long Waves.—Tune set and oscillator to 1,200 metres (250 kc.), and adjust T3 to bring in the signal spot on.

Short Waves.—BAND 1, 13.5 TO 52 METRES.—Tune set and oscillator to 14 metres (21.4 mcs.), and adjust T4 for maximum output. Check calibration at 50 metres. BAND 2, 50 TO 200 METRES.—There are no trimming adjustments to be effected on this band.

Pre-set Stations.—To RE-SET TRIMMERS connect an aerial and earth to the receiver as for ordinary broadcast reception. With the receiver on its side (pre-

ferably with the mains transformer nearest the test bench) the trimmers from top to bottom are in line with and correspond to the station names on the W/L panel. The oscillator trimmers are those nearest the rear of the chassis.

Turn the selector switch so that the station name "Droitwich" lights up, tune in the actual station spot on (with the aid of the visual tuning indicator) by means of the corresponding oscillator trimmer, and then adjust the aerial trimmer for maximum volume.

The other stations should be treated in the same manner in turn. To CHANGE A PRE-SET STATION.—There are two long-wave and three medium-wave station settings. These, if desired, can be changed from the stations originally set by the makers. Choice of two long-wave and three medium-wave can be obtained.

To change a station very close in wavelength to the original station it will only be necessary to adjust the trimmers to tune in the desired station.

To change to a station appreciably different in wavelength from the original station, it will be necessary to obtain from the makers a set of two fixed condensers and connect these across the oscillator and aerial trimmers in place of those already fitted.

As sent out the station names are engraved on a celluloid strip. Remove this strip by lifting out from behind dial backplate, and, with a pair of scissors, cut out the superseded station or stations.

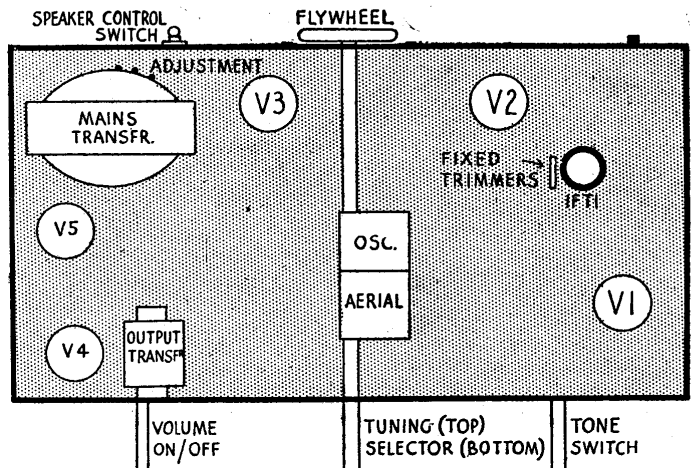

ferably with the mains transformer nearest the test bench) the trimmers from top to bottom are in line with and correspond to the station names on the W/L panel. The oscillator trimmers are those nearest the rear of the chassis.

Replacement Condensers

Replacement condensers are available from A. H. Hunt, Ltd., Garratt Lane, Wandsworth, London, S.W.18, for the Invicta Model 500. These are: for either C39 or C40, unit list number 2,935, 1s. 9d., and for the block C32, unit 1,573, 6s. 6d.

FREE with **THREE**

Unbreakable NEON TESTER

FREE to you with three LAB Kits (as on right). Needed every day for testing fuses, identifies A.C., D.C. & R.F., etc. Neon glows on only .0005 amp. current, and will never 'blow' (like other Neon testers). A necessity to all servicemen.

CARDED KITS

LAB VOLUME CONTROLS

or LAB FUSES

VOLUME CONTROL KIT. 12 assorted controls, 5000 ohm to 1 megohm, retail 3/- & 3/6, each on display card. Retail value of Kit 39/-.

FUSE KIT. 24 assorted fuses, 6d. each. Neon tester FREE with 3 of either Kit, or two of one and one of other.

Order immediately: only limited number of testers available.

RADIO RESISTOR CO LTD

