

# LISSEN

## SERVICE MANUAL FOR THREE VALVE BAND PASS BATTERY RECEIVER MODEL 8306

### TECHNICAL SPECIFICATION

THE model 8306 is a three-valve band-pass receiver for use with an external aerial. The wavebands covered are 200-550 metres, and 850-1,900 metres.

The three valves employed are :—

- V1—Variable-mu H.F. Pentode (Metallised)  
Ever Ready K50N.
- V2—Triode Detector (Metallised)  
Ever Ready K30K.
- V3—Output Pentode Ever Ready K70B

An inductively coupled band-pass filter precedes the H.F. amplifier, and control of volume is obtained by varying the bias on this valve. The resistance R3 prevents the H.F. bias being reduced below a certain value, and the potentiometer R4 enables a large bias voltage to be applied to the valve for volume control purposes.

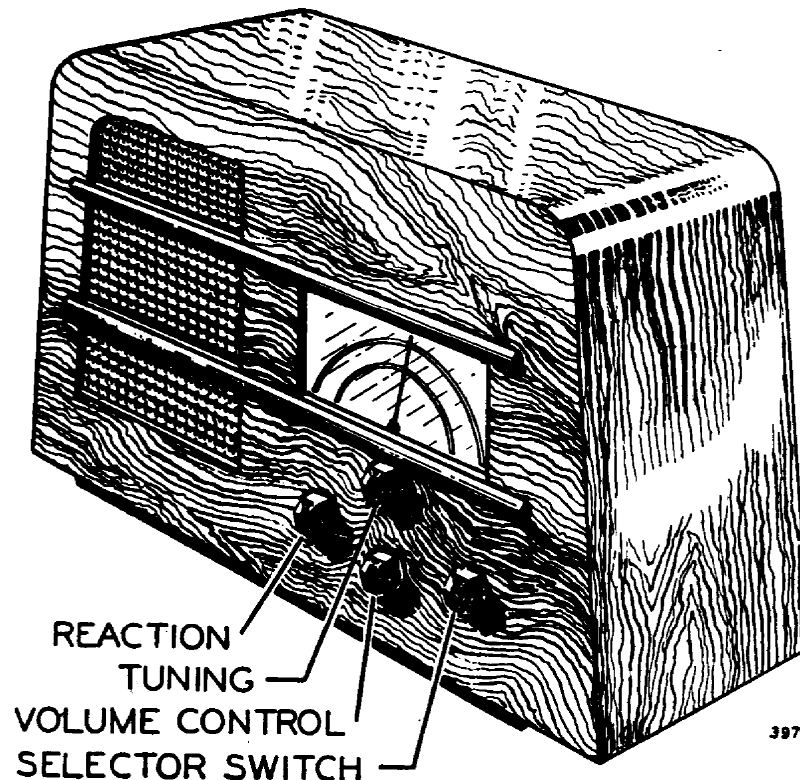

The coupling between the H.F. and Detector valves is through the condenser C11 to the tuned grid coils L6 and L7. Reaction is applied to the Detector through the coils L8 and L9 by varying the capacity of C14.

The L.F. coupling to the Output valve is through the condenser C15 to the Parallel-feed transformer T1.

Resistances R8 and R9 provide the total bias voltage which is available for reducing the gain of the H.F. valve when required; the output pentode bias is provided by R8 alone.

The three wave-change switches, S1, S3 and S4, are closed in the medium wave position and open in the long wave position. The "On-Off" switch (S2) is, of course, closed when the receiver is switched on.

# SERVICE DATA FOR BATTERY RECEIVER MODEL No. 8306.

OPERATING CONDITIONS OF VALVES			
Valve	Electrode	Voltage	Current
H.F. Amplifier (E.R. K50N)	Anode ..	108	1.5 mA.
	Screen ..	38	0.7 mA.
	Bias ..	0.6—9.5	—
Detector (E.R. K30K)	Anode ..	43	0.5 mA.
Output Pentode (E.R. K70B)	Anode ..	105	4.2 mA.
	Screen ..	109	0.7 mA.
	Bias ..	—3.8	—

Total H.T. Current (Volume Control at max.) .. 7.6 mA.  
 " " " ( " " " min.) .. 6.8 mA.  
 " L.T. " .. 0.37 amp.  
 Bias volts with Volume Control at max. .. 10.9 volts.  
 " " " " " min. .. 9.5 "

NOTE.—All voltages over 50 measured with a Universal Avometer on 1,200-volt range.

RESISTORS			
Code	Description	Part No.	Values
R1	V1 Screen Feed ..	71,962	110,000 ohm, $\frac{1}{2}$ watt
R2	V1 Decoupling ..	71,944	510,000 ohm, $\frac{1}{2}$ watt
R3	Minimum Bias Resistor ..	71,960	250 ohm, $\frac{1}{2}$ watt
R4	Volume Control ..	81,503	5,000 ohm
R5	V2 Anode Decoupling ..	71,974	26,000 ohm, $\frac{1}{2}$ watt
R6	V2 Anode Load ..	71,962	110,000 ohm, $\frac{1}{2}$ watt
R7	V3 Grid Stopper ..	71,962	110,000 ohm, $\frac{1}{2}$ watt
R8	Bias Resistor ..	71,961	800 ohm, $\frac{1}{2}$ watt
R9	Bias Resistor ..	71,906	1,500 ohm, $\frac{1}{2}$ watt
R10	V2 Detector Grid Leak ..	71,902	2.1 megohm, $\frac{1}{2}$ watt

CONDENSERS			
Code	Description	Part No.	Values
C1	Aerial Coupling Condenser ..	71,262	10 mmfd.
C2	Aerial Coupling Condenser ..	66,503	100 mmfd. Mica
C3	B.P.1 Tuning ..	80,504	3-gang Condenser on Gang
C4	B.P.2 Tuning ..		
C5	H.F. Tuning ..		
C6	B.P.1 Trimmer ..		
C7	B.P.2 Trimmer ..		
C8	H.F. Trimmer ..	68,020	0.1 mfd.
C9	Grid Decoupling ..		
C10	V1 Screen Bypass ..	68,020	0.1 mfd.
C11	H.F. Coupling ..	66,502	50 mmfd. Mica
C12	V2 Detector Grid Condenser ..	66,502	50 mmfd. Mica
C13	V2 Anode By-pass ..	66,506	500 mmfd. Mica
C14	Reaction Condenser ..	80,505	500 mmfd.
C15	L.F. Coupling ..	68,005	0.01 mfd.
C16	Tone Correction ..	68,005	0.01 mfd.
C17	Bias By-pass Condenser ..	67,005	50 mfd., 12-v. peak Electrolytic
C18	V2 Anode Decoupling ..	68,019	0.5 mfd.

INDUCTANCES			
Code	Description	Part No.	Values
L1	Primary Coil ..	78,510	
L2	M.W. B.P.1 Coil ..		
L3	L.W. B.P.1 Coil ..		
L4	M.W. B.P.2 Coil ..		
L5	L.W. B.P.2 Coil ..	78,511	
L6	M.W. H.F. Coil ..		
L7	L.W. H.F. Coil ..		
L8	M.W. Reaction Coil ..		
L9	L.W. Reaction Coil ..	13,894	
L10	H.F. Choke ..		

VALVES			
Code	Description	Part No.	Values.
V1	H.F. Pentode ..	4,091	K50N
V2	Detector ..	4,090	K30K
V3	Output Pentode ..	4,058	K70B

TRANSFORMERS			
Code	Description	Part No.	Values
	L.F. Transformer, 6—1 ..	77,506	
	Output Transformer on P.M. Speaker ..		

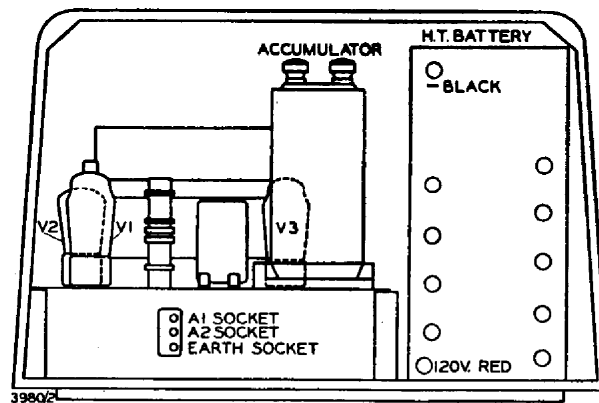

Fig. 7.

## CIRCUIT ALIGNMENT PROCEDURE FOR LISSEN 8306.

Note.—C1 and C2, etc., refer to trimmers as indicated in Service Manual, Fig. Nos. 4 and 5.

### Medium Wave Band Alignment.

(1) See that the scale pointer registers with the 180°s line on the scale with gang condenser at max. capacity.

(2) Set the pointer against the 214-metre mark on scale.

(3) Apply a signal of 214 metres to the A1 and E sockets of the receiver and adjust trimmers C6, C7 and C8 on top of gang condenser sections for maximum output. This must be done with critical reaction, obtained by adjustment of the reaction condenser C14.

(4) Check calibration at 300 metres and 500 metres, with critical reaction in each case. See that the receiver tunes down to 200 metres.

### Long Waveband.

No alignment is required on this waveband, but a check must be made for scale calibration at 1,200 metres and 1,700 metres, with critical reaction, by applying the appropriate signal to the A1 and E sockets of the receiver.

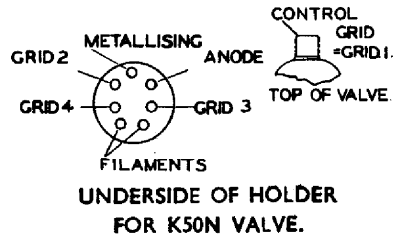

UNDERSIDE OF HOLDER FOR K50N VALVE.

Fig. 1.

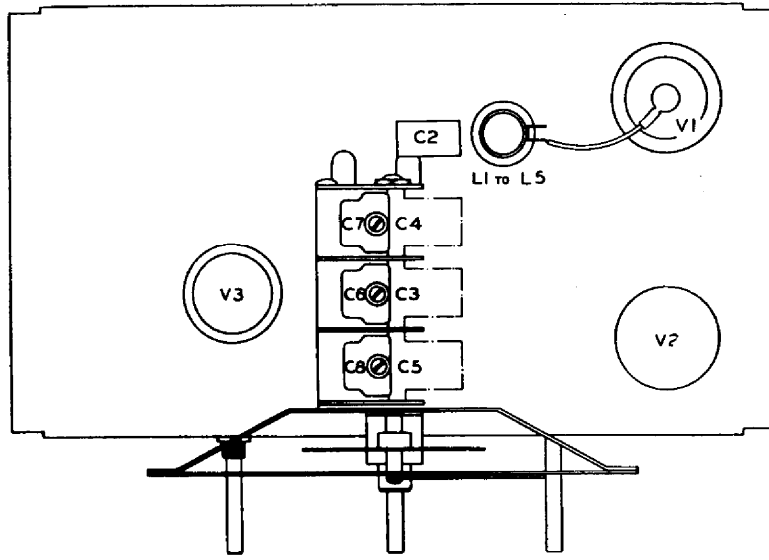

Fig. 4.

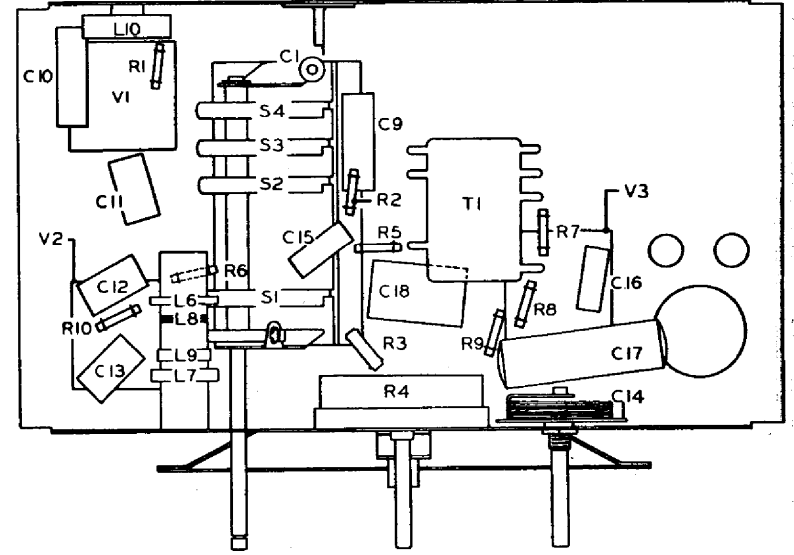
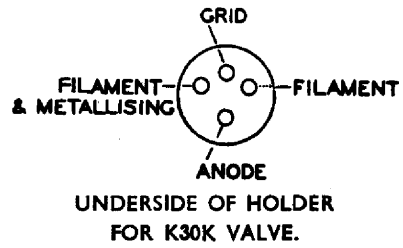
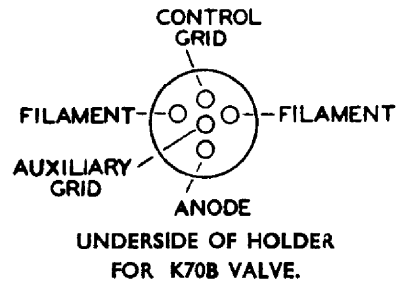

Fig. 5.



UNDERSIDE OF HOLDER FOR K30K VALVE.

Fig. 2.



UNDERSIDE OF HOLDER FOR K70B VALVE.

Fig. 3.

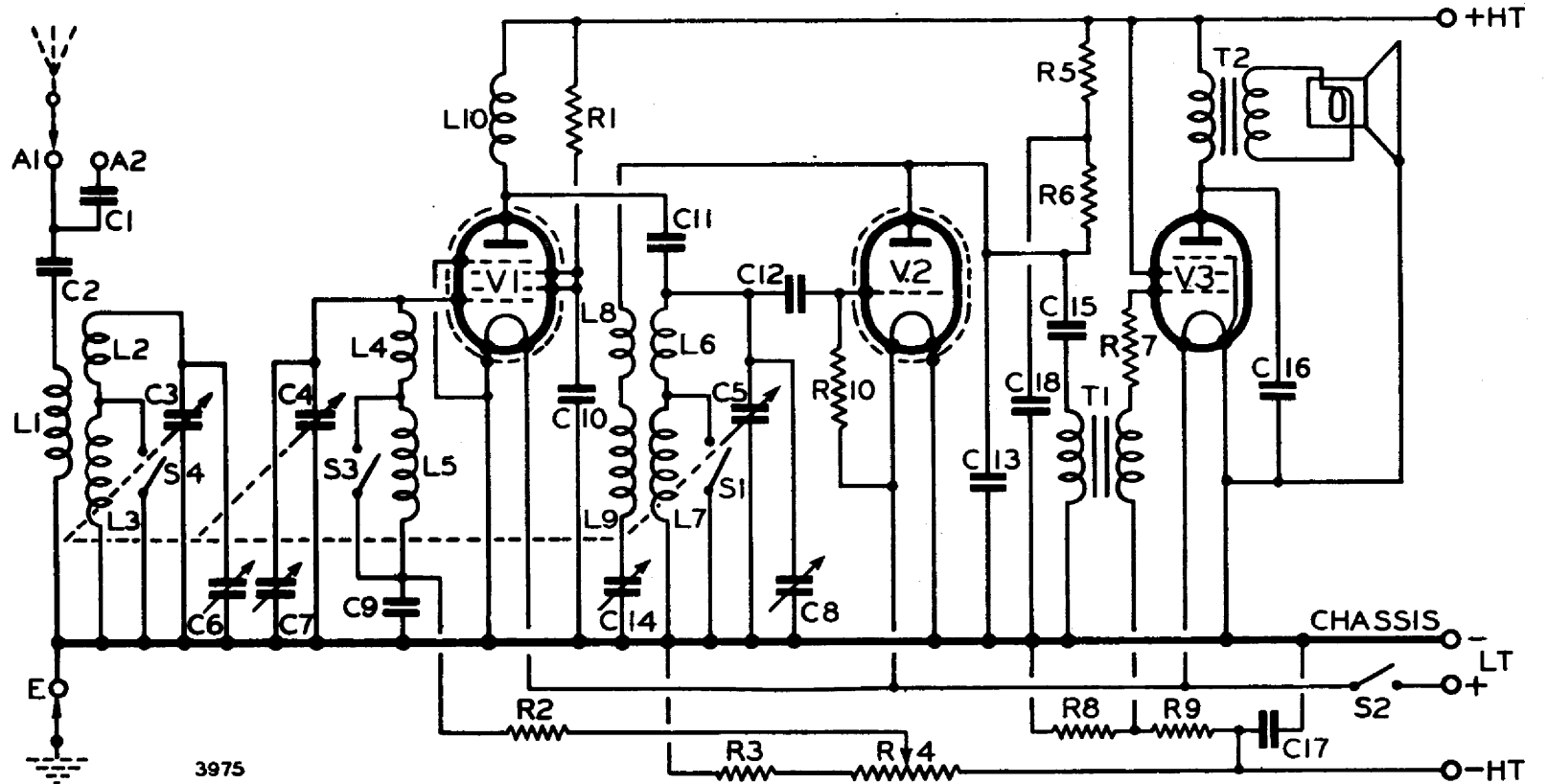

3975

CIRCUIT DIAGRAM

Fig. 6.