



PHILCO



Radio Service Bulletin No. 43

Published by the Philco Radio & Television Corporation of Great Britain, Ltd., Perivale, Greenford, Middlesex

Model 99. Baby Grand.

TYPE CIRCUIT: Seven-valve Superheterodyne with pre-selector H.F. amplifier, automatic volume control and push-pull Pentode Output (7 watts), for operation on Long, Medium and Short-wave bands. Built-in connections for Philco All-wave Aerial—aerial selector built into and operated by the wave-change switch. Provision is made by means of a Jack for connecting a pick-up for gramophone reproduction.

POWER SUPPLY: Alternating current mains of 100-130 volts, or 200-260 volts, 40-100 cycles when the correct connections are made on the series parallel primary winding. (See Circuit Diagram.)

WAVE-BANDS: COVERAGE: Three (a) Long, 150-350 Kc. (2,000-857 metres); (b) Medium, 550-1,700 Kc. (545-176.5 metres); (c) Short, 6-18 Mc. (50-16.6 metres.)

TUNING DRIVE: Dual planetary, ball-bearing, ratios 10-1 and 50-1 for slow and accurate tuning. Glowing arrow wave-band indicator and shadow-meter tuning device.

tone CONTROL: Four positions giving full tone, normal, bright, and mellow reproduction.

INTERMEDIATE FREQUENCY: 451 Kc.

POWER CONSUMPTION: 90 watts.

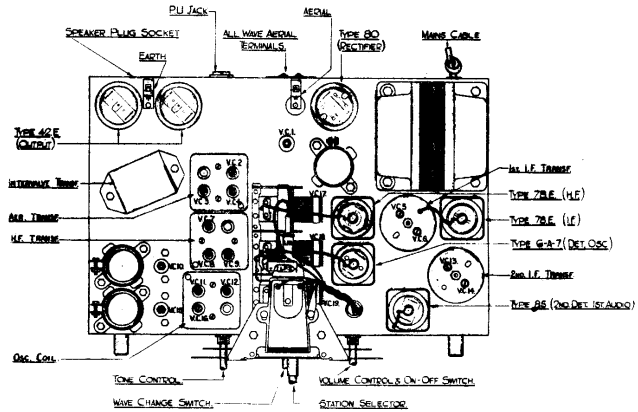

MODEL 99,
TOP CHASSIS DIAGRAM.

TABLE I. VOLTAGES.

Valve socket readings to chassis taken with an 025 or 099 Philco Set Tester using the 300, 30 and 10 volt ranges. Volume control at minimum, wave-change switch in M.W. position, gang condenser fully open and no aerial connected. A.C. Line—245v. 50 cycles.

POSITION.	VALVE.	ANODE	SCREEN	BIAS
H.F. Amplifier S4	78E	Pin 3. 225 volts †† Pin 3. 80 volts	Pin 4. 90 volts	Pin 5 -2.5 volts
1st Detector and Oscillator S.5.	6A7	Pin 3. 225 volts Pin 5. 150 volts*	Pin 4. 90 volts	—
I.F. Amplifier S.6	78E	Pin 3. 235 volts	Pin 4. 90 volts	Pin 5 -2.5 volts
2nd Det. A.V.C. and 1st L.F. Amplifier S.7	85	Pin 3. 40 volts	—	Pin 4 0.1 volts †
Pentode Output S.1.	42E	Pin 3. 250 volts	Pin 4. 260 volts	-16**
Pentode Output S.2.	42E	Pin 3. 250 volts	Pin 4. 260 volts	—
Full-wave Rectifier S.3.	80	Pin 3. 330v. A.C. Pin 4. 330v. A.C.	—	—

* Oscillator Anode volts. † Diode volts. †† S4 Anode volts measured with SW.2 in Short Wave position.
** Bias measured between chassis and R.1/3. Total D.C. 335 volts (measured between R.1/3 and EC.2/2).

TABLE 2. RESISTANCES OF COILS.

REF. NO.	TEST PROD 1	TEST PROD 2	RESIST. (OHMS)	REF. NO.	TEST PROD 1	TEST PROD 2	RESIST. (OHMS)
WT1	"Aerial"	VC1/2	15	T4 Secondary	V7 Cap	TB3/1	10
T1 Tappings	TB5/1	TB5/2	SW2 L.W. Zero SW2 M.W. 12.5 SW2 S.W. 0.5	T5 Primary	V7/3	TB8	12
T1 Primary	"Aerial"	Chassis	SW2 L.W. 175 SW2 M.W. 115 SW2 S.W. 0.5	T5 Secondary	V6/5	C18/1	10
T1 Secondary	V4 Cap	T1/7	SW2 L.W. 50 SW2 M.W. 5 SW2 S.W. 0.1	Shadowmeter	TB8	EC1/2	3,500 approx.
T2 Primary	V4/3	C2/1	SW2 L.W. 25,000 approx. SW2 M.W. 25,000 approx. SW2 S.W. 5	T1A Primary	C1/3	Chassis	400 approx.
T2 Secondary	V5 Cap	TB3/1	SW2 L.W. 50 SW2 M.W. 5 SW2 S.W. 0.1	T1A Secondary	TB1/1 TB1/1	V1/5 V2/5	3,500 approx. 3,500 approx.
T3	V5/6	SW2-2/2	SW2 L.W. 15 SW2 M.W. 3.5 SW2 S.W. 0.1	T6 Primary	S8/2	V1/3	350
T3 Reaction	V5/5	TB4/1	0.5	T6 Primary	S8/2	V2/3	350
T4 Primary	V5/3	C2/1	12	T6 Secondary	Outp't Trfmr.	Outp't Trfmr.	0.2
				Speech Coil	Lead 1	Lead 2	2.0
				CK.1	S8/2	S8/3	435
				P.T. Primary			
				200-260 volts	TB10/2	C19/3	8
				100-130 volts	TB10/2	C19/3	2
				H.T. Secondary	V3/3	R1/3	60
				H.T. Secondary	V3/4	R1/3	60
				Rectifier L.T.	V3/1	V3/2	0.1†
				Heaters L.T.	V1/2	Chassis	0.2†

* Resistance of T6 secondary alone and speech coil alone (taken when disconnected).
† Resistance of L.T. windings taken with all valves removed.
NOTE: Reference numbers for valves should be read in conjunction with the socket numbers, e.g., V1.—S.1.

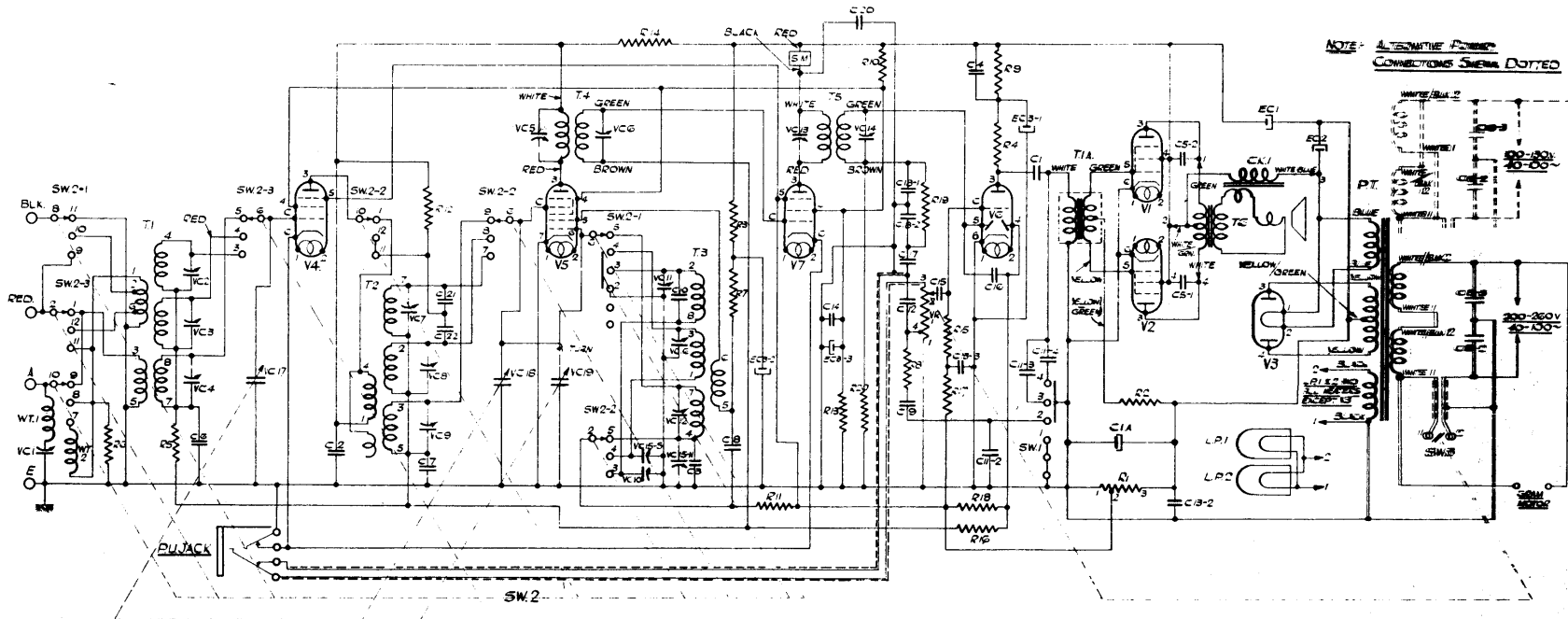

NOTE: ALTERNATIVE POWER CONNECTIONS SHOWN DOTTED

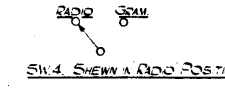
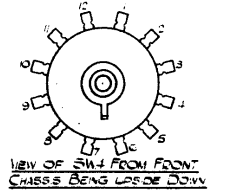
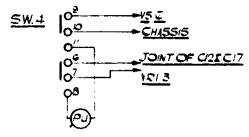

NOTE: REVISED WIRING OF PICK-UP CONNECTIONS & LOCATION OF SW-1 & SW-2 MOTOR CONNECTIONS ON MODEL 99 RG ONLY

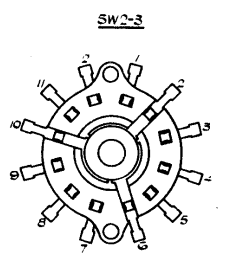
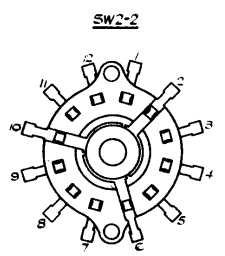
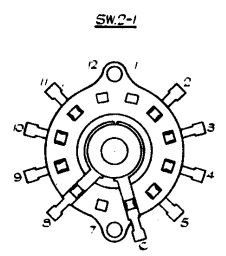

VIEWS OF SWITCHES FROM FRONT CHASSIS BEING UPSIDE DOWN

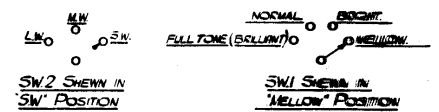

MODEL 99, CIRCUIT DIAGRAM.

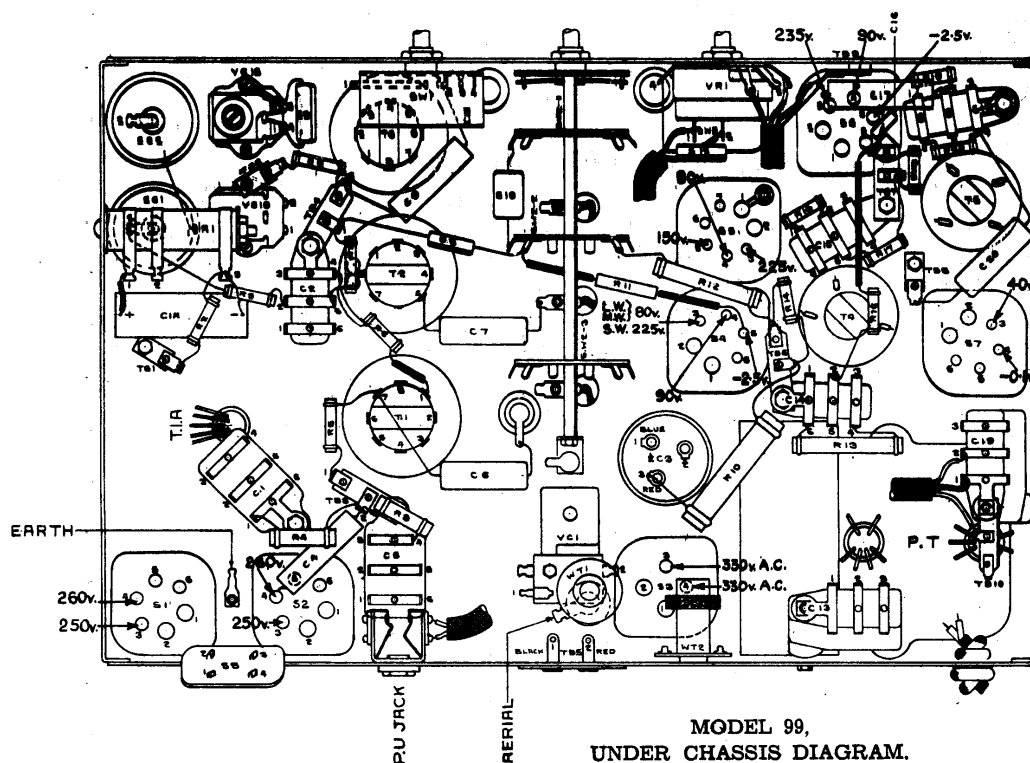

MODEL 99,
UNDER CHASSIS DIAGRAM.

ALIGNMENT PROCEDURE.

Before leaving the factory, all Philco receivers are accurately aligned, but if mis-alignment is suspected through damage it should not be attempted without instruction in the correct adjustment of the trimming and padding condensers. It should only be carried out with the aid of an accurately calibrated Signal Generator covering Long, Medium and Short wave frequencies, and for this purpose the PHILCO ALL-PURPOSE SET TESTER MODEL 077 is recommended.

Connect the Output Meter across the Primary of the Output Transformer, *i.e.*, green and white leads. With gang condenser fully closed, check that indicator reads on index line.

Set wave-change switch to M.W. (2nd position), and turn gang open to fullest extent. Turn volume control to maximum and tone control fully counter-clockwise.

INTERMEDIATE FREQUENCY: The I.F. trimmers (VC's 14, 13, 6 and 5) should first be roughly adjusted in that order by feeding in a 451 Kc. signal from the Signal Generator to the grid cap of the 6A7 valve (with grid lead disconnected) and the Signal Generator earthed to the receiver chassis. Adjust the Signal Generator attenuator to give a half scale reading on the Output Meter.

Transfer Signal Generator lead via a Standard Dummy to the Aerial terminal. Replace grid lead of 6A7 valve and retrim VC's 14, 13, 6 and 5 for maximum output.

WAVE TRAP: With the same connection, trim VC.1 for *minimum* output.

LONG WAVES: Turn wave-change switch to L.W. (1st position, left hand) and set gang at 290 Kc. Feed in a 290 Kc. signal and trim VC's 11, 7 and 2 in that order for maximum output.

Feed in and tune a 160 Kc. signal. Rock gang and pad VC.10 for maximum output. Readjust trimming at 290 Kc. and padding at 160 Kc. until no further improvement is obtainable.

MEDIUM WAVES: Turn wave-change switch to M.W. (2nd position) and set gang condenser to 1,400 Kc. Feed in a signal of 1,400 Kc. and trim VC's 16, 8 and 3 for maximum output. Feed in and tune a 600 Kc. signal. Rock gang and pad VC.15 (screw) for maximum output. Readjust trimming at 1,400 Kc. and padding at 600 Kc. until no further improvement results.

SHORT WAVES: Turn wave-change switch to S.W. (3rd position, right hand). Substitute a 400 ohms resistor for the Standard Dummy, and feed in an 18 Mc. signal. Set gang at 18 Mc. and adjust VC.12 for the second signal heard from tight (care is necessary as the two peaks are narrowly spaced). Next trim VC's 9 and 4 roughly, and check for Image at approximately 17.1 Mc.

NOTE: Due to the very small difference between the pre-selector and oscillator frequencies, the adjustment of VC's 9 and 4 will have a tendency to "pull" or change the frequency of the oscillator. By shunting a 21 plate variable condenser (approx. .00035 mfd.) across the oscillator (front) section of the gang and tuning it so that the second harmonic, instead of the fundamental, beats with the incoming signal, this "pull" can be minimised.

Connect the shunt condenser across VC.19, and tune it (about half open) for signal at 18 Mc. Trim VC's 9 and 4 for maximum output. Disconnect shunt condenser and retrim VC.12.

Feed in and tune a 6 Mc. signal. Rock gang and pad VC.15 (nut) for maximum output.

Readjust trimming at 18 Mc. as above, and padding at 6 Mc. until no further gain can be obtained.

Check calibration.

Model 99 — Radiogram

The Model 99 Radiogram is a 7-valve superheterodyne receiver employing the same circuit as the Model 99 Baby Grand, but with the following refinements:—

GRAMOPHONE: Automatic record changing equipment is incorporated, which will play either eight 10-inch or eight 12-inch records consecutively, if desired; any record can be rejected whilst the instrument is in operation should it be desired to do so, and the turntable is automatically stopped at the conclusion of the final record of any series. Single eight-inch records also can be played.

Provision is made for the use of an external speaker.

Operation of the gramophone is controlled by a separate switch located below the wave-change switch which makes change over from radio to gram, without the possibility of radio break-through.

CONTROLS: All controls are on the motor board.

REMOVAL OF CHASSIS: This is easily effected by loosening the bracket nuts inside cabinet, allowing the chassis to be lowered and lifted out after the knobs have been removed.

TOP CHASSIS DIAGRAM: Pick-up-Jack removed.

CIRCUIT DIAGRAM: Revised wiring of pick-up connections, change over switch, and gram. motor connections shown on diagram.

UNDER CHASSIS DIAGRAM: Pick-up-Jack removed. S.W.4 and mounting bracket fastened to front of chassis by means of nut fixing S.W.2. Pick-up lead and mains cable for motor added.

Tables 1 and 2 and Alignment Procedure are the same as for Model 99 Baby Grand.

TABLE 3.—PARTS AND PRICE LIST.

Delete:—

REF. NO.	DESCRIPTION.	PART NO.
T.6 CK.1	Output Transformer, Speech Coil and Cone } Field Coil - - - - - } Speaker complete Type K.31	36-1151
EC.1	Electrolytic Condenser, 8 mfd. - - - - -	30-2025
EC.2	Electrolytic Condenser, 12 mfd. - - - - -	30-2117
	Electrolytic Condenser Insulator - - - - -	27-7194
	Pick-up-Jack - - - - -	6585

Add:—

REF. NO.	DESCRIPTION.	PART NO.	LIST PRICE
			£ s. d.
T.6 CK.1	Output Transformer, Speech Coil and Cone } Field Coil - - - - - } Speaker complete	360-1022	57 9
EC.1	Electrolytic Condenser, 8 mfd. - - - - -	300-2000	4 9
EC.2	Electrolytic Condenser, 12 mfd. - - - - -	300-2001	5 8
SW.4	Radio-gram Switch - - - - -	42-1164	2 2
	Pick-up Cable - - - - -	LO-1033	1 0
	Motor Cable - - - - -	LO-1002	1 0
	Automatic Record Changer, Motor, Turntable and } Pick-up Assembly, complete. Type RC.3 - }	350-2007	10 0 0
	Extension Speaker Lead - - - - -	LO-1031	1 2

TABLE 3 - PARTS AND PRICE LIST.

Reference No.	DESCRIPTION.	Part No.	List Price s. d.	Reference No.	DESCRIPTION.	Part No.	List Price s. d.									
WT.1	I.F. Trap Assembly - - -	38-6850	6 6	R.6	¼ watt Carbon Resistor 3,000 ohms. - - - -	33-1030	9									
VC.1				Image Suppressor Coil Assembly	32-2069	1 1	R.7	¼ watt Carbon Resistor 15,000 ohms. - - - -	33-1177	9						
WT.2	Aerial Transformer Coil Assembly - - -	32-1664	17 6	R.8	¼ watt Carbon Resistor 25,000 ohms. - - - -	33-1013	9									
T.1				H.F. Transformer Coil and Trimmer Assembly - - -	32-1666	16 3	R.9	½ watt Carbon Resistor 32,000 ohms. - - - -	5279	9						
VC.2							Fixed Condenser 1.5 mmfd. - -	32-1666	16 3	R.10	3 watt Carbon Resistor 16,000 ohms. - - - -	7500	2 3			
VC.3										Fixed Condenser 1.5 mmfd. - -	32-1666	16 3	R.11	¼ watt Carbon Resistor 51,000 ohms. - - - -	6098	9
VC.4													Oscillator Coil Assembly - - -	32-2016	17 6	R.12
T.2				1st I.F. Transformer Assembly -	32-1835	10 0	R.13	1 watt Carbon Resistor 20,000 ohms. - - - -	6649	9						
VC.7							2nd I.F. Transformer Assembly	32-1836	9 6	R.14	¼ watt Carbon Resistor 4,000 ohms. - - - -	33-1031	9			
VC.8				Output Transformer } Speaker	36-1151	27 6				R.15	¼ watt Carbon Resistor 1 meg. - - - -	33-1096	9			
VC.9							Speech Coil & Cone } complete	36-1151	27 6	R.16	¼ watt Carbon Resistor 1 meg. - - - -	33-1096	9			
C.21				Interval Transformer - - -	32-7532	19 9				R.17	¼ watt Carbon Resistor 490,000 ohms. - - - -	6097	9			
C.22	3-Gang Condenser - - - -	31-1555	22 6				R.18	¼ watt Carbon Resistor 1 meg. - - - -	33-1096	9						
T.3				Single moulded padder, 250 mmfd. - - - -	31-6081	1 4	R.19	¼ watt Carbon Resistor 51,000 ohms. - - - -	6098	9						
VC.11	Double Moulded Padder, 1,500+ 600 mmfd. - - - -	31-6027	2 11				R.20	¼ watt Carbon Resistor 330,000 ohms. - - - -	33-1200	9						
VC.12				Electrolytic Condenser 35 mfd. - - - -	300-2007	1 3	VR.1	Volume Control 1 megohm (tap at 225,000 ohms.) - - - -	33-5113	8 9						
VC.16	Moulded Condenser .15+.15 mfd. - - - -	6287-DU	2 6				SW.3	On-off Switch - - - -	42-1153	8 9						
T.4				Moulded Condenser .05 mfd. - - - -	3615-SG	9	SW.2-1	Wavechange Switch - - - -			42-1153	8 9				
VC.5	Mica Condenser .0025 mfd. - - - -	7006-equiv	1 1				SW.2-2		Power Transformer	32-7464			28 6			
VC.6				Tubular Condenser .06 mfd. - - - -	30-4114	1 3	SW.2-3							100-130-v. } 40-100 cycles	32-7464	28 6
T.5	Moulded Condenser .002+.002 mfd. - - - -	7296-DU	2 6				P.T.	200-260-v. }			32-7464	28 6				
VC.13				Tubular Condenser .05 mfd. - - - -	30-4020	7	LP.1		Scale Pilot Lamp Bulb - - - -	34-2039			1 4			
VC.14	Mica Condenser 250 mmfd. - - - -	30-1056-equiv.	8				LP.2							Shadowmeter Pilot Lamp Bulb - - - -	34-2064	1 4
T.6				Tubular Condenser .05 mfd. - - - -	30-4020	7	S.M.	Dial and Hub Assembly - - - -			31-1775	3 0				
CK.1	Mica Condenser 50 mmfd. - - - -	30-1029-equiv.	4						Shadowmeter - - - -	27-5184			1 6			
T.1A				Fixed Condenser .015 mfd. - - - -	30-1019	8								Scale - - - -	270-5037	1 6
VC.17	Fixed Condenser .01 mfd. - - - -	30-4406	3 6				Glowing Arrow Mask - - - -	27-5160			6	6				
VC.18				Fixed Condenser .015 mfd. - - - -	30-4406	3 6			Glowing Arrow Screen - - - -	27-5159			3			
VC.19	Tone Control Switch - - - -	30-1031-equiv.	8											Electrolytic Condenser Insulator - - - -	27-7194	1
VC.10				Mica Condenser 110 mmfd. - - - -	300-1020	8	Shadowmeter - - - -	450-2001-P			6 6	6 6				
VC.15	Moulded Condenser .09+.09 mfd. - - - -	4989-DG	1 3						Speaker Cable - - - -	02722			1 7			
C1A				Moulded Condenser .09 mfd. - - - -	4989-SU	9								Bezel Assembly - - - -	40-5724	2
C.1	Moulded Condenser .01 mfd. - - - -	3903-SU	7				Valve Shield - - - -	28-2726			2	doz. 5				
C.2				Mica Condenser 110 mmfd. - - - -	30-1031-equiv.	8			Grid Clip - - - -	28-2214			doz. 5			
C.3	Tubular Condenser .05 mfd. - - - -	30-4020	7											Knob, Tuning - - - -	27-4206	3
C.4				Moulded Condenser 110+110 mmfd. - - - -	8035-DG	1 0	Knob, Slow Speed Tuning - - - -	27-4207			3	3				
C.5	Mica Condenser .015+.015 mfd. - - - -	3793-DG	8						Knob, Wavechange - - - -	27-4225			3			
C.6				Moulded Condenser .09+.09 mfd. - - - -	4989-DG	1 3								Knob, Volume, Tone - - - -	27-4208	3
C.7	Moulded Condenser .09 mfd. - - - -	4989-SU	9				Knob Spring - - - -	280-5262			doz. 2	5				
C.8				Moulded Condenser .01 mfd. - - - -	3903-SU	7			Mains Lead and Plug - - - -	380-5043			5			
C.9	Mica Condenser 250 mmfd. - - - -	30-1056-equiv.	8											6-Prong Socket - - - -	27-6036	5
C.10				Fixed Condenser .015 mfd. - - - -	300-1019	8	6-Prong Socket - - - -	27-6036			5	5				
C.11-2	Fixed Condenser .01 mfd. - - - -	30-4406	3 6						7-Prong Socket - - - -	27-6037			5			
C.11-3				Fixed Condenser .015 mfd. - - - -	30-4406	3 6								6-Prong Socket - - - -	27-6036	5
C.11-4	Tone Control Switch - - - -	30-1031-equiv.	8				6-Prong Socket - - - -	27-6036			5	5				
SW.1				Mica Condenser 110 mmfd. - - - -	300-1020	8			6-Prong Socket - - - -	27-6036			5			
C.12	Moulded Condenser .09+.09 mfd. - - - -	4989-DG	1 3											6-Prong Socket - - - -	27-6036	5
C.13				Moulded Condenser .09 mfd. - - - -	4989-SU	9	7-Prong Socket - - - -	27-6037			5	5				
C.14	Moulded Condenser .01 mfd. - - - -	3903-SU	7						6-Prong Socket - - - -	27-6036			5			
C.15				Mica Condenser 110 mmfd. - - - -	30-1031-equiv.	8								6-Prong Socket - - - -	27-6036	5
C.16	Tubular Condenser .05 mfd. - - - -	30-4020	7				6-Prong Socket - - - -	27-6036			5	5				
C.17				Moulded Condenser 110+110 mmfd. - - - -	8035-DG	1 0			4-Prong Socket - - - -	27-6043			6			
C.18	Mica Condenser .015+.015 mfd. - - - -	3793-DG	8											Type 42E Pentode Output Valve - - - -	6447E	14 0
C.19				Moulded Condenser .015+.015 mfd. - - - -	3793-DG	8	Type 42E Pentode Output Valve - - - -	6447E			14 0	0				

TABLE 3 - PARTS AND PRICE LIST (contd.)

C.20	Tubular Condenser .02 mfd. -	30-4113	1 3	V.2	Type 42E Pentode Output Valve - - - - -	6447E	14 0
EC.1	Electrolytic Condenser 8 mfd. -	30-2025	8 0	V.3	Type 80 Full Wave Rectifier Valve - - - - -	3149	8 0
EC.2	Electrolytic Condenser 12 mfd.	30-2117	9 0	V.4	Type 78E Variable-mu H.F. Pentode Valve - - - - -	8315E	13 0
EC.3	Electrolytic Condenser 1+1+2 mfd. - - - - -	30-2080	8 0	V.5	Type 6A7 Variable-mu Heptode Valve - - - - -	34-2002E	16 0
R.1	Wire-wound Resistance 24+136 ohms. - - - - -	33-3236	9	V.6	Type 85 Double Diode Triode Valve - - - - -	7532	12 0
R.2	¼ watt Carbon Resistor 240,000 ohms. - - - - -	33-1097	9	V.7	Type 78E Variable-mu H.F. Pentode Valve - - - - -	8315-E	13 0
R.3	¼ watt Carbon Resistor 15,000 ohms. - - - - -	33-1177	9		Chassis Mounting Washer (Rubber) - - - - -	27-4201	doz. 3
R.4	¼ watt Carbon Resistor 99,000 ohms. - - - - -	4411	9		Chassis Mounting Cushion (Rubber) - - - - -	27-4202	2
R.5	¼ watt Carbon Resistor 51,000 ohms. - - - - -	6098	9		Pick-up Jack - - - - -	6585	3 6