

Accuphase

MDS COMPACT DISC PLAYER

DP-500

- Newly developed high-rigidity, high-precision CD drive
- MDS++ type D/A converter
- Jitter-free high-performance digital demodulator
- Direct Balanced Filter with separate analog low-pass filtering for balanced and unbalanced signal paths
- Two sets of digital inputs
- Two sets of transport outputs
- Fully digital control of CD mechanism





Dedicated high-end CD player for ultimate musical fidelity — New high-rigidity, high-precision drive mechanism optimized for CD reproduction. Processor section features MDS++ type D/A converter with four parallel DACs. Independent construction of transport section and digital processor. One set each of coaxial and optical connectors for digital input and transport output.

The Compact Disc format with its 20-year history offers an unsurpassed wealth of musical treasures. Audiophiles the world over therefore covet the Accuphase lineup of high-end dedicated CD players. As the latest entry in this category, the DP-500 features a CD drive mechanism for the first time developed in house, of course with our famous dedication to quality and attention to detail. Combine this with the latest digital signal processing technology, and the result is a breathtaking CD player that will make you rediscover the joys of music.

The CD mechanism in the DP-500 was developed with a simple yet demanding aim: extract the information encoded on the CD one-hundred percent. Using all of its accumulated know-how and expertise, Accuphase has created an extremely rigid and ultra precise transport mechanism that attains new levels of performance.

The processor section employs four strictly selected high-performance delta-sigma devices operating in parallel, forming a further refined MDS++ D/A conversion system. The analog filter, which has a significant influence on sound quality, is a so-called "Direct Balanced Filter" that provides totally separate analog low-pass filtering (5-pole Butterworth) for the balanced and unbalanced signal paths. This brings out the full musical potential of the CD. The outstanding sound and high performance of the D/A converter section can be accessed also by external equipment. A set of optical and coaxial digital inputs accepts digital signals from other components, for processing with the highest musical accuracy.



Coaxial input indication



Optical input indication

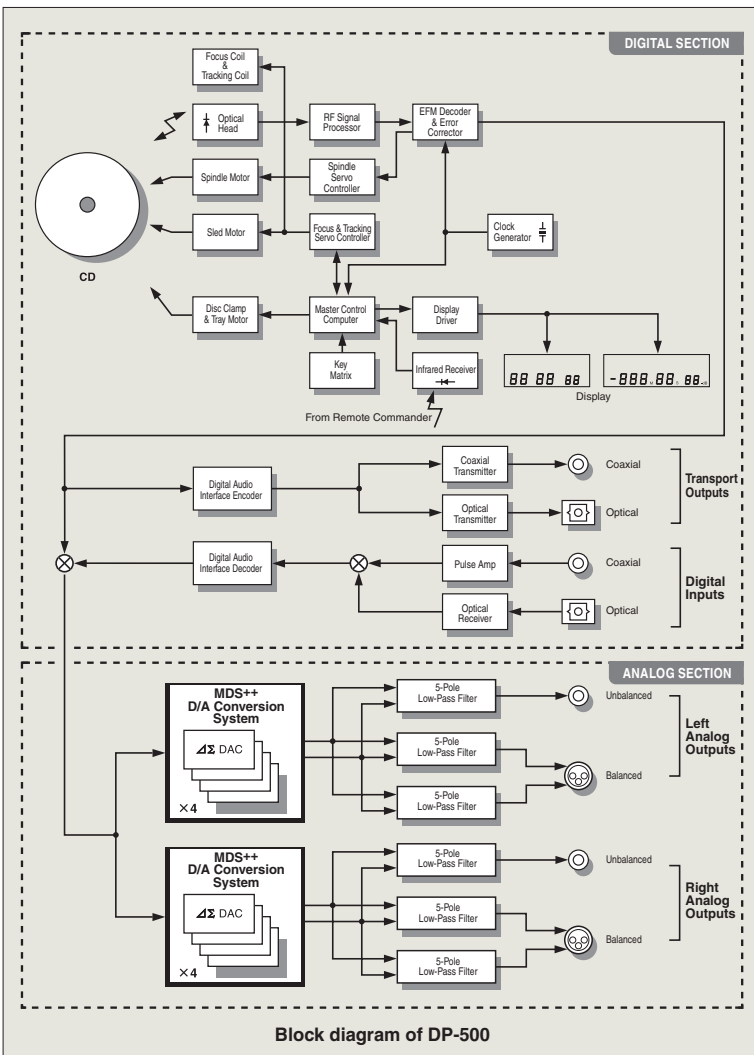

MDS++ D/A converter

MDS (Multiple Delta Sigma) is a revolutionary design which employs several delta sigma type converters in a parallel configuration. In the combined output of these multiple converters, conversion errors cancel each other out, resulting in a drastic improvement in all relevant aspects of converter performance such as accuracy, S/N ratio, dynamic range, linearity, and THD. In the DP-500, four delta sigma type PCM1796 converters (made by Texas Instruments) are driven in parallel. Compared to a single converter, this results in an overall performance improvement by a factor of 2 ($= \sqrt{4}$).

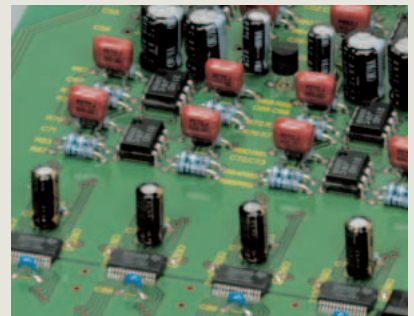

As shown in the diagram, the MDS++ features an enhanced current-to-voltage (I/V) converter for processing the D/A converter output current. A combination of current summing and voltage summing is used, resulting in even better stability and top-notch performance. The music emerges from a totally silent background, with breathtaking detail resolution and accurate spatial information.

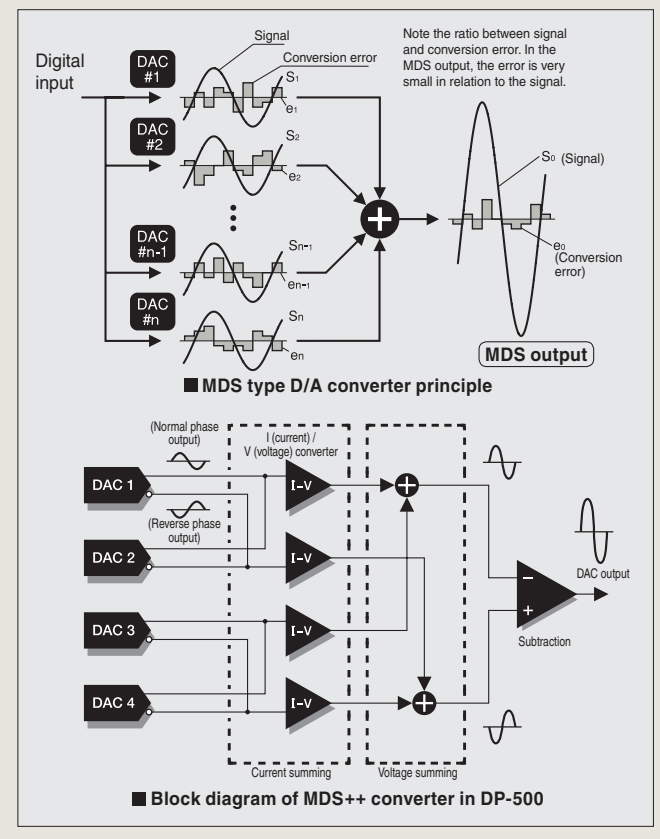
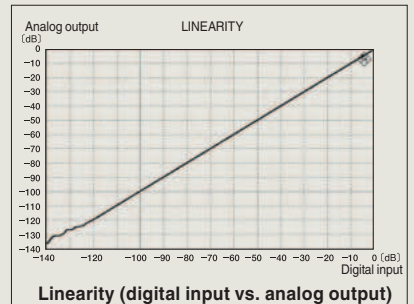

Transport section features newly developed high-rigidity, high-precision CD drive

In order to extract the minute bits of information from the rapidly spinning disc and decode these accurately into a digital signal of high purity, vibrations emanating from the rotating medium as well as external mechanical vibrations must be minimized. At the same time, the prevention of resonances is also highly important.

In the DP-500, the CD drive base is mounted firmly to a strong metal frame, forming a highly rigid chassis construction. Conversely, the traverse mechanism, an integrated structure consisting of the optical assembly including laser pickup and rotating parts, is designed for extremely light weight and isolated by a floating suspension

arrangement from the mechanism base. Specially selected material is used for viscous damping, supporting the traverse mechanism at four points.

A large, sturdy bridge-type cover is joined to the mechanism base for reinforcement. The entire CD drive assembly is directly mounted to the bottom chassis, which in turn features four large cast iron insulator feet with superior damping characteristics. The result is a unit with a low center of gravity and excellent protection against all kinds of adverse influences from vibrations. Perfectly stable and quiet operation produces a signal of utmost accuracy.

- **Sturdy chassis absorbs external vibrations**
- **Highly rigid and precise construction**
- **Traverse mechanism with floating design and viscous damping**
- **Integrated design with large bridge joined to mechanism base**
- **Low center of gravity and efficient vibration control**
- **High-quality CD tray made of extruded aluminum, plus quiet and smooth disc loading mechanism**
- **"High Carbon" cast iron insulator feet with superior damping characteristics further enhance sound quality**

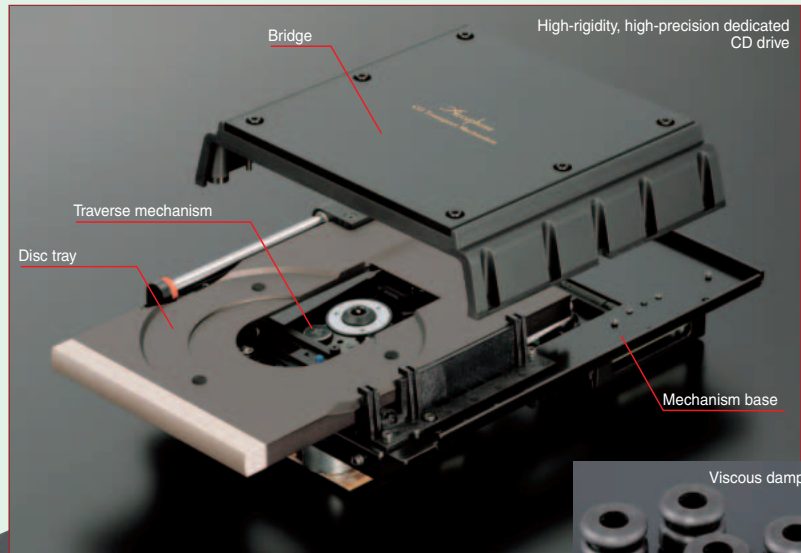

CD transport section features and functions

- **Fully digital control of CD mechanism**
- **Laser pickup with integrated RF amplifier for drastically reduced noise interference**
- **Balanced drive circuitry for actuator control eliminates interaction with other circuits**
- **Power-on play feature allows automatic playback**

- **Supplied remote commander RC-100**
Provides access to direct play, input source selection, level control, repeat play, program play and other functions.



Direct Balanced Filter with separate balanced/unbalanced circuitry

The output of any D/A converter contains so-called aliasing noise in the very high frequency range. During CD playback, an analog filter designed to remove that noise is therefore always required.

The filter circuitry in the DP-500 uses 5-pole Butterworth analog filters with extremely flat frequency response in the passband. In order to prevent unwanted interaction, completely separate filters are provided for the balanced and unbalanced signal paths. A direct connection from the balancing circuit at the output of the D/A converter to the filter circuitry and symmetrical +/- configuration ensures that the +/- output impedance is also identical. This provides ideal transmission conditions for the high-quality MDS++ output.

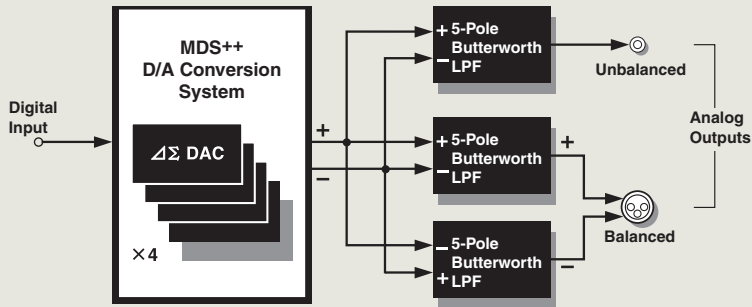

Front panel

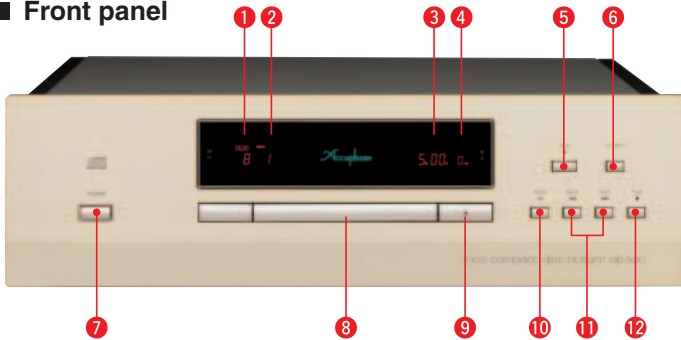

Rear panel



- | | |
|--|---|
| 1 Play track indicator | 11 Track search buttons |
| 2 Total track/index indicator | 12 Stop button |
| 3 Time indicator | 13 Digital input connectors (coaxial, optical) |
| 4 Output level indicator | 14 Transport output connectors (coaxial, optical) |
| 5 Play button | 15 Balanced output connectors (analog) |
| 6 CD transport/processor selector button | ① Ground |
| 7 Power switch | ② Inverted (-) |
| 8 Disc tray | ③ Non-inverted (+) |
| 9 Disc tray open/close button | 16 AC power connector* |
| 10 Pause button | 17 Unbalanced output connectors (analog) |

Remarks

- * This product is available in versions for 120/230 V AC. Make sure that the voltage shown on the rear panel matches the AC line voltage in your area.
- * The shape of the AC inlet and plug of the supplied power cord depends on the voltage rating and destination country.

- Supplied accessories:
 - AC power cord
 - Audio cable with plugs (1 meter)
 - Remote Commander RC-100

Connection example for DG-38

The transport output of the DP-500 can be connected (via coaxial or optical fiber cable) to the digital input of the DG-38, for processing of the CD transport signal in the digital domain.

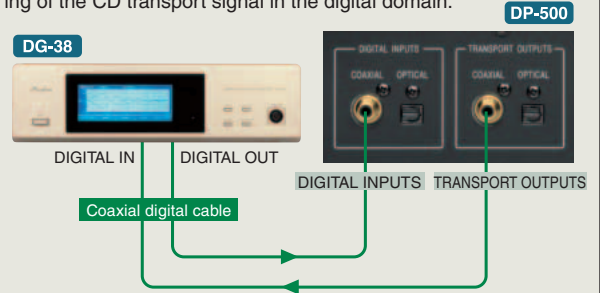

- Independent processor section with coaxial and optical fiber inputs supports signal formats up to a sampling frequency of 96 kHz/24 bits
- CD transport section with coaxial and optical fiber outputs allows digital recording of CD signal
- Balanced and unbalanced analog outputs
- Digital level control allows adjustment down to -60 dB

GUARANTEED SPECIFICATIONS

[Guaranteed specifications are measured according to the JEITA standard CP-2402A.]
[Measurement disc: JEITA CP-2403A]

CD Transport

- **Format:**
 - Standard CD format
 - Quantization: 16 bits
 - Sampling frequency: 44.1 kHz
 - Error correction principle: CIRC
 - Number of channels: 2
 - Revolution speed: 500–200 rpm (CLV)
 - Scan velocity: 1.2–1.4 m/s, constant
- **Data read principle:** Non-contact optical pickup
- **Laser:** GaAIs (double hetero-junction visible-spectrum semiconductor laser diode)
- **Transport output level:**
 - COAXIAL (IEC 60958): 0.5 V_{p-p}, 75 ohms
 - OPTICAL (JEITA CP-1212): Light output -21 to -15 dBm
 - Wavelength 660 nm

Digital Processor

- **Input format** (IEC 60958/AES-3 compliant)
 - Quantization: 16–24 bits, linear
 - Sampling frequency: 32 kHz, 44.1 kHz, 48 kHz, 88.2 kHz, 96 kHz
- **Digital input level:**
 - COAXIAL (IEC 60958): 0.5 V_{p-p}, 75 ohms
 - OPTICAL (JEITA CP-1212): Light output -27 to -15 dBm
- **Frequency response:** 4 to 20,000 Hz ±0.3 dB
- **D/A converter:** 24 bits, MDS++ type
- **Total harmonic distortion:** (20–20,000 Hz, 24-bit input) Max. 0.001%
- **Signal-to-noise ratio:** 114 dB or better
- **Dynamic range:** 110 dB or better
- **Channel separation:** 110 dB or better
- **Output voltage and impedance:**
 - BALANCED: 2.5 V into 50 ohms, balanced XLR type
 - UNBALANCED: 2.5 V into 50 ohms, RCA-type phono jacks
- **Output level control:** 0 to -60 dB in 1-dB steps (digital type)

General

- **Power requirements:** AC120 V/230 V, 50/60 Hz (Voltage as indicated on rear panel)
- **Power consumption:** 20 W
- **Max. dimensions:**
 - Width 465 mm (18-5/16")
 - Height 150 mm (5-7/8")
 - Depth 393 mm (15-1/2")
- **Mass:**
 - 16.6 kg (36.6 lbs) net
 - 22.0 kg (48.5 lbs) in shipping cartion
- **Supplied Remote Commander RC-100**
 - Remote control principle: Infrared pulse
 - Power supply: Two IEC R03 (size AAA) batteries
 - Max. dimensions: 56 mm × 175 mm × 26 mm
 - Weight: 155 g (including batteries)



ACCUPHASE LABORATORY, INC.