

Accuphase

COMPACT DISC PLAYER

DP-57

- MDS++ D/A converter achieves amazingly low distortion and superb S/N ratio
- Jitter-free high-performance digital demodulator
- 3-pole analog filter with outstanding phase characteristics
- Two sets of digital inputs
- Two sets of transport outputs
- Fully digital control of CD mechanism
- Balanced drive circuitry for servo motors





A player dedicated to CD playback – Fully independent transport and digital processor sections. MDS++ type D/A converter for even better performance. Optical and coaxial digital inputs and transport outputs provide added flexibility. Fully digital control of CD mechanism achieves optimization of servo parameters in real time.

The DP-57 was created by further refining the Accuphase model DP-55V using the very latest in digital technology. The end product is a player solely dedicated to reproducing Compact Disc sources with impeccable quality.

Although the number of discs released in SACD format is increasing, the CD which boasts a history of over 20 years is still the main source format for music lovers the world over. The “capability to reproduce existing CDs with even higher sound quality” was a wish often voiced by audiophiles, and Accuphase has responded by further strengthening its lineup of dedicated CD players. As a result of intensive and innovative research, Accuphase helps listeners rediscover the immense musical potential of the CD, by making discs sound as lively and detailed as never before.

The DP-57 features totally separate CD transport and processor sections, allowing individual use of each. The processor employs an ultra-precise 24-bit D/A converter using a newly developed MDS++ converter. This takes the MDS (Multiple Delta Sigma) principle pioneered by Accuphase to new heights. All electrical characteristics have been further improved, as exemplified by minimal distortion, extremely low noise, and superb linearity. The outstanding sound quality and high performance of the processor section can be accessed also by external digital



Display example for optical input



Display example for coaxial input

components, via the optical and coaxial digital inputs. The high conversion accuracy of the D/A converter ensures that any digital signal will be reproduced with optimum fidelity. The transport section is also equipped with two outputs (optical and coaxial). This allows connection of a digital recorder for formats such as CD-R, DAT, or MD, to record the signal from the CD transport of the DP-57 in the digital domain.

CD Transport Section Features and Functions

Fully digital control of CD mechanism

Control of the mechanism section is fully digital, allowing the use of adaptive circuits to optimize servo performance for each individual disc. This results in a drastically reduced error rate and enhanced operation stability, even when the ambient temperature fluctuates.

Laser pickup with integrated RF amplifier

The pickup used in the DP-57 employs a miniature RF amplifier which is so compact that it can be directly mounted in the photodetector pickup assembly. This provides a high-level output signal free from noise interference, which in turn reduces the error rate.

Balanced drive circuitry for servo motors

The motors and actuators which move the disc tray, spindle, sled, and the focussing and tracking assembly are driven by two amplifiers arranged in a balanced configuration. Because there is no circuit flowing in the ground line, the operation of other circuits in the player remains entirely unaffected.

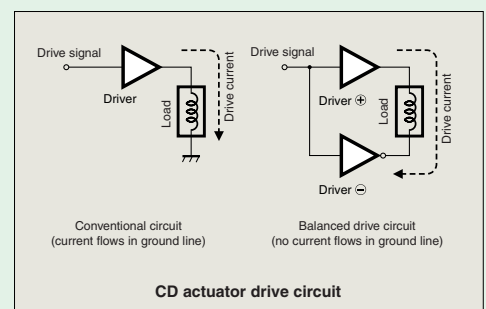

Tray lock prevents resonances

If the disc tray which is used to slide the disc into the unit resonates due to vibrations generated in the rotating assembly while the disc is playing, signal quality can be degraded. In the DP-57, the tray is firmly secured during playback, to eliminate any possibility of harmful resonances.

Power-on play and frame display

“Power-on play” means that the DP-57 can start playback when power is turned on, allowing automatic playback in conjunction with an audio timer. For precise location of any spot on a disc, the player can display frame information (1 frame = 1/75 second), and functions such as repeat can be carried out in steps of individual frames.

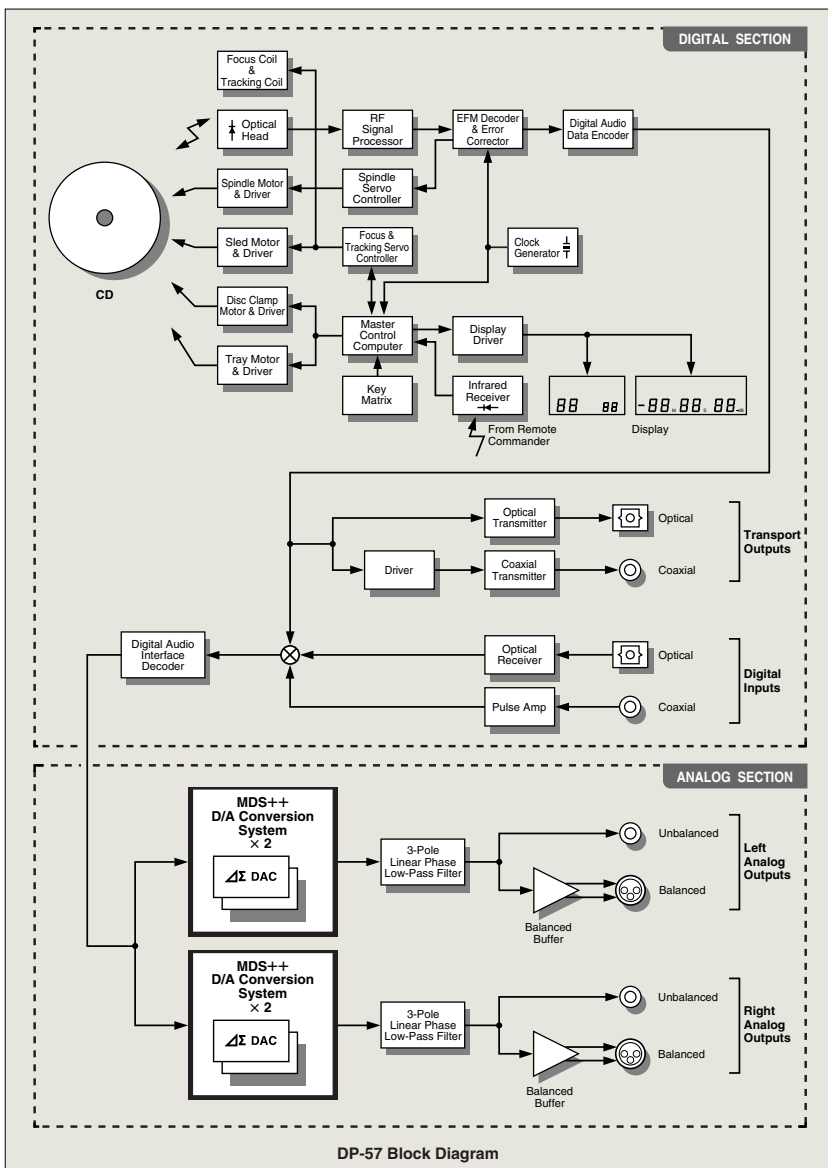

MDS++ D/A converter moves another step ahead

MDS (Multiple Delta Sigma) is a revolutionary design which employs several delta sigma type converters in a parallel configuration.

In the combined output of these multiple converters, conversion errors cancel each other out, resulting in a drastic improvement in all relevant aspects of converter performance including accuracy, S/N ratio, dynamic range, linearity, and THD.

In the DP-57, two delta sigma type PCM1796 converters (made by Texas Instruments) are driven in parallel. Compared to a single converter, this results in an overall performance improvement by a factor of 1.4 ($=\sqrt{2}$).

As shown in the diagram, the MDS++ used in the DP-57 features an enhanced current-to-voltage (I/V) converter for processing the D/A converter output current.

In combination with voltage summing, this design results in even better stability and top-notch performance. The music emerges from a totally silent background, with breathtaking detail resolution and accurate spatial information.

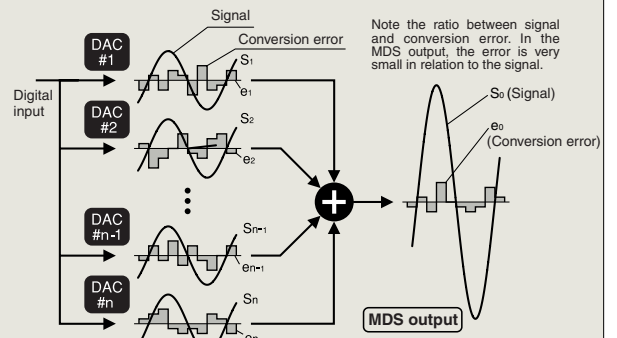
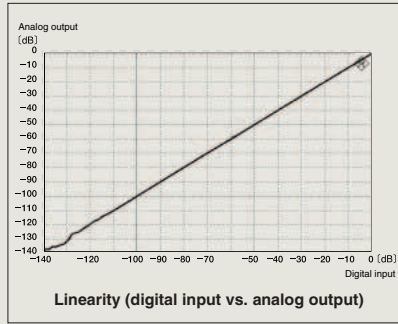
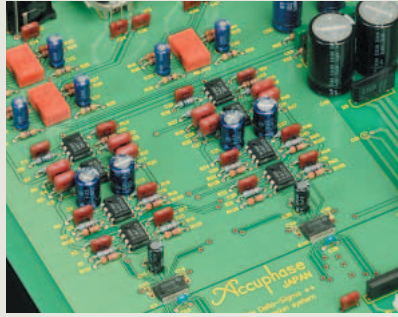

■ MDS type D/A converter principle

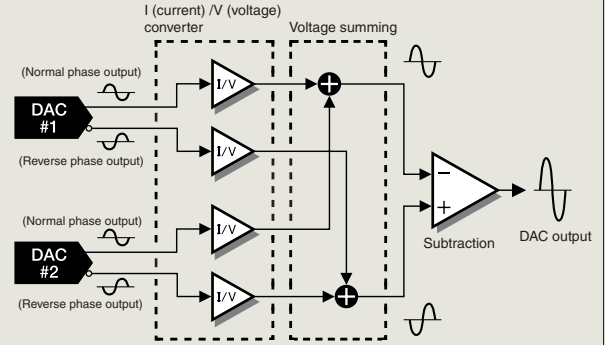

■ Block diagram of MDS++ converter in DP-57

■ Assembly with CD transport control circuitry, digital inputs, transport outputs, MDS++ D/A converter, 3-pole analog filter, balanced/unbalanced analog output circuitry, power supply, etc.

■ Supplied remote commander RC-18
Offers a host of functions such as input switching, direct play, program play, repeat, etc.



Digital Processor Section Features and Functions

■ **MDS++ type D/A converter** achieves stunning performance and sound quality



Delta Sigma D/A converter

■ **Jitter-free high-performance digital demodulator**
The demodulator used in the DP-57 for processing the supplied digital signal produces extremely low jitter and significantly reduces any jitter components that may be present in the input signal.

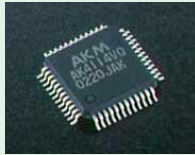

Digital demodulator IC

■ **3-pole linear phase analog filter with outstanding phase characteristics**
The cutoff frequency setting of the analog filter circuitry is optimized in order to keep phase shift in the passband to a minimum. Only strictly selected components are used, resulting in excellent music playback quality.

■ **Digital level control with 0 dB to -40 dB adjustment range**

■ **Two sets of balanced and unbalanced analog output connectors**



Balanced and unbalanced analog output connectors

Front panel

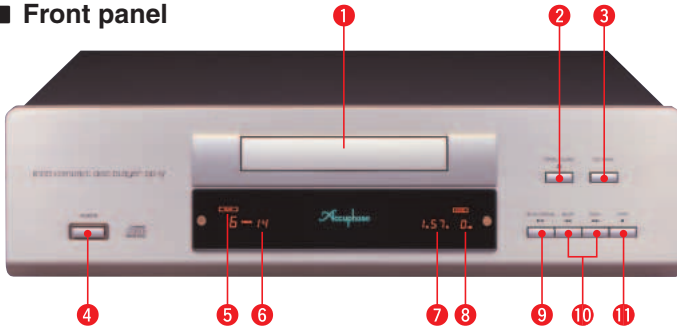

Rear panel

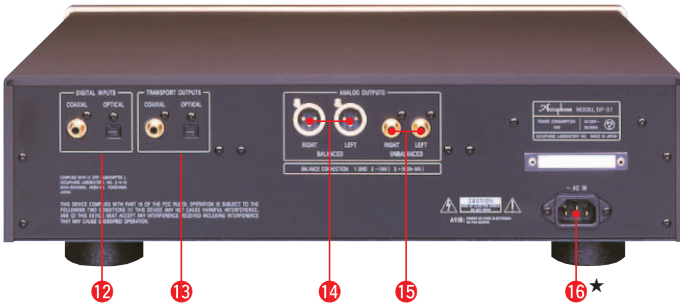

- | | |
|--|---|
| 1 Disc tray | 9 Play/pause button |
| 2 Disc tray open/close button | 10 Track search buttons |
| 3 CD transport/processor selector button | [processor operation:
external input selector buttons] |
| 4 Power switch | |
| 5 Play track indicator | 11 Stop button |
| [processor operation:
digital input indicator] | 12 Digital input connectors (coaxial, optical) |
| | 6 Track/index indicator |
| [processor operation:
sampling frequency indicator] | 14 Balanced output connectors (analog) |
| | 7 Time indicator |
| 8 Output level indicator | 15 Unbalanced output connectors (analog) |
| | 16 AC power connector* |

Remarks

★ This product is available in versions for 120/230 V AC. Make sure that the voltage shown on the rear panel matches the AC line voltage in your area.

★ The shape of the AC inlet and plug of the supplied power cord depends on the voltage rating and destination country.

- Supplied accessories:
- AC power cord
 - Audio cable with plugs (1 m)
 - Remote Commander RC-18

■ **Independent processor section.** Coaxial and optical digital input connectors accept signals with a sampling frequency up to 96 kHz and resolution up to 24 bit.

■ **Coaxial and optical transport output connectors** allow direct copy of digital signal from transport section.

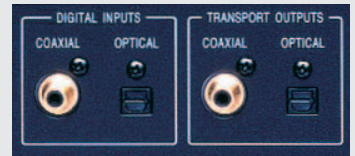

Digital input connectors

Transport output connectors

■ **"High Carbon" cast iron insulator feet** with superior damping characteristics further enhance sound quality

NOTES

- ◎ **Proper playback (operation/sound quality) of CCDs is not assured.**
 - Copy Control CDs (CCCDs) and other types of discs implementing some form of copyright protection may not play properly on Accuphase CD players, because such discs may not conform to existing CD standards. No assurances are made regarding playback and sound quality when using such discs.
 - For detailed information regarding CCCDs, please contact the disc manufacturer.
- ◎ **Only discs conforming to existing CD standards can be played on this player.** Check the label on the disc before attempting to use it in this player.

GUARANTEED SPECIFICATIONS

[Guaranteed specifications are measured according to the EIA standard CP-2402.]
[Measurement disc: CP-2403]

CD Transport

- **Format:** Standard CD format

Quantization:	16 bits
Sampling frequency:	44.1 kHz
Error correction principle:	CIRC
Number of channels:	2
Revolution speed:	500 - 200 rpm (constant linear velocity)
Scan velocity:	1.2 - 1.4 m/s, constant
- **Data read principle:** Non-contact optical pickup (semiconductor laser)
- **Laser type:** GaAIs (double heterodyne diode)
- **Transport output level (EIAJ CP-1201)**

OPTICAL:	Output -21 to -15 dBm Wavelength 660 nm
COAXIAL:	0.5 Vp-p, 75 ohms

Digital Processor

- **Input format:** EIAJ CP-1201 compatible

Quantization:	16 - 24 bits, linear
Sampling frequency:	32 kHz, 44.1 kHz, 48 kHz, 88.2 kHz, 96 kHz
- **Digital input level (EIAJ CP-1201):**

OPTICAL:	Input -27 to -15 dBm
COAXIAL:	0.5 Vp-p, 75 ohms
- **D/A converter:** MDS++ type, 24 bits Digital deemphasis
- **Frequency response:** 4.0 to 20,000 Hz ±0.3 dB
- **Total harmonic distortion:** Max. 0.001% (20 - 20,000 Hz, 24-bit input)
- **Signal-to-noise ratio:** 114 dB or better
- **Dynamic range:** 110 dB or better (24-bit input)
- **Channel separation:** 110 dB or better
- **Output voltage and impedance:**

BALANCED:	2.5 V into 50 ohms, balanced XLR type
UNBALANCED:	2.5 V into 50 ohms, RCA-type phono jacks
- **Output level control:** 0 to -40 dB in 1-dB steps (digital)

General

- **Power requirements:** AC 120 V/230 V, 50/60 Hz
(Voltage as indicated on rear panel)
- **Power consumption:** 14 W
- **Maximum Dimensions:**

Width	475.0 mm (19-11/16")
Height	140.0 mm (5-1/2")
Depth	395.5 mm (15-9/16")
- **Mass:**

	11.7 kg (25.8 lbs) net
	16.0 kg (35.3 lbs) in shipping carton
- **Supplied Remote Commander RC-18**

Remote control principle:	Infrared pulse
Power requirements:	3 V DC, IEC R6 (size AA) batteries × 2
Dimensions:	55 mm × 194 mm × 18 mm
Weight:	100 g (including batteries)