

# Accuphase

INTEGRATED STEREO AMPLIFIER

## E-250

m Revolutionary AAVA-II volume control  
m Parallel push-pull output stage with high-power transistors delivers plenty of quality power  
m Instrumentation amplifier principle in power amplifier section allows fully balanced signal transmission  
m Current feedback topology  
m Logic-control relays for straight and short signal paths  
m Robust power supply with large transformer and high filtering capacity





# AAVA-II (Accuphase Analog Vari-gain Amplifier) type volume control

AAVA-II (Accuphase Analog Vari-gain Amplifier) is a novel volume control concept that completely does away with variable resistors in the signal path. Because the music signal does not have to pass through such devices, there is no adverse influence from changes in impedance. This means that the outstanding S/N ratio and low distortion of the amplifier are not compromised in any way, and the same superb sound quality will be obtained at any volume setting.

AAVA-II input stage employs current feedback principle that ensures high-speed, low-noise operation and assures excellent characteristics at high output voltages.

Volume control resolution  
The listening volume is adjusted by a combination of 16 V-I converters. The number of possible volume steps is 2 to the power of 16 = 65,536, as determined by current switches.

AAVA-II circuitry is deceptively simple  
Because AAVA-II employs circuitry that is electrically very simple, long-term reliability is excellent, with performance and sound

quality that will remain unchanged also after prolonged use.

AAVA-II means analog processing  
The AAVA-II circuit converts the music signal from a voltage into a current, to allow control by current switches, and then back into a voltage. The entire process is carried out in the analog domain.

No more left/right tracking differences or crosstalk  
Because AAVA-II is an electronic circuit employing only fixed-value resistors, there is virtually no left/right tracking error also at low volume levels, and crosstalk also does not present a problem.

AAVA-II maintains high S/N ratio and uniform frequency response

Because AAVA-II does not introduce any change in impedance, there is no deterioration of S/N ratio or alteration of frequency response. Changing the volume with AAVA does not mean introducing noise or otherwise degrading the sound quality of the amplifier.

Control knob gives same operation feel as with a conventional high-quality volume control.

Attenuator and balance control also implemented by AAVA-II

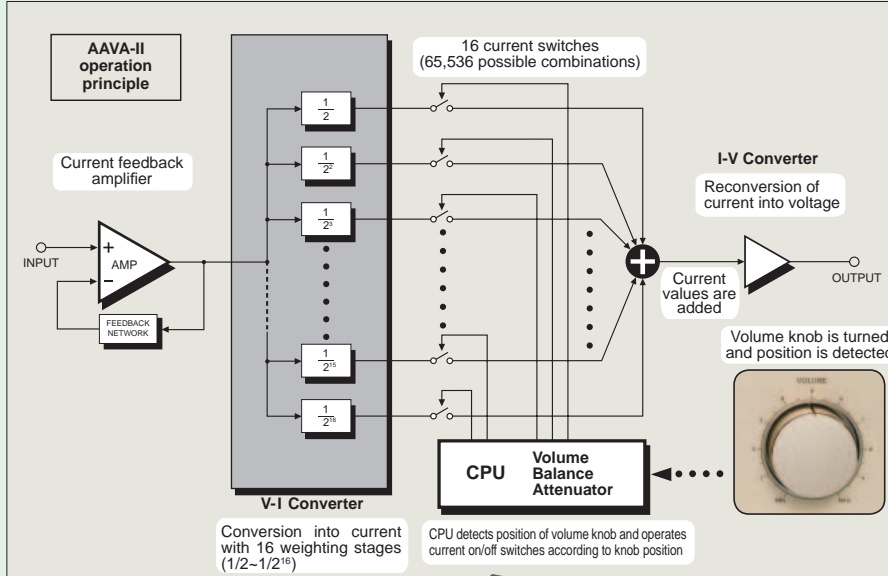

## How AAVA-II works

AAVA-II operates by feeding the music signal to a V-I (voltage - current) converting amplifier where it is weighted in 16 steps [ $1/2, 1/2^2, \dots, 1/2^{15}, 1/2^{16}$ ]. The 16 current steps are turned on or off by 16 current switches, and the combination of switch settings determines the overall volume. The switching operation is controlled by a CPU according to the position of the volume control knob. The combined signal current forms a variable gain circuit that adjusts the volume. Finally, the combined current is converted back into a music signal voltage by an I-V (current - voltage) converter.

AAVA-II volume control assembly with higher integration density of components and circuitry

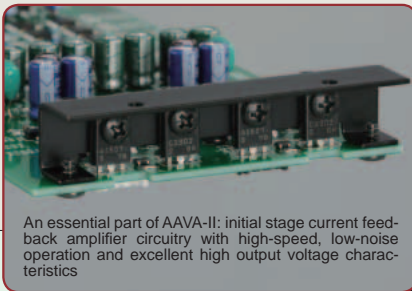

Supplied remote commander RC-200  
Allows volume adjustment and input source switching.

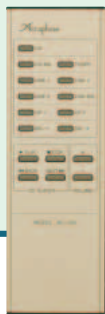

Power amplifier assembly featuring parallel push-pull output stage directly mounted to large heat sink, instrumentation amplifier configuration, and current feedback circuitry

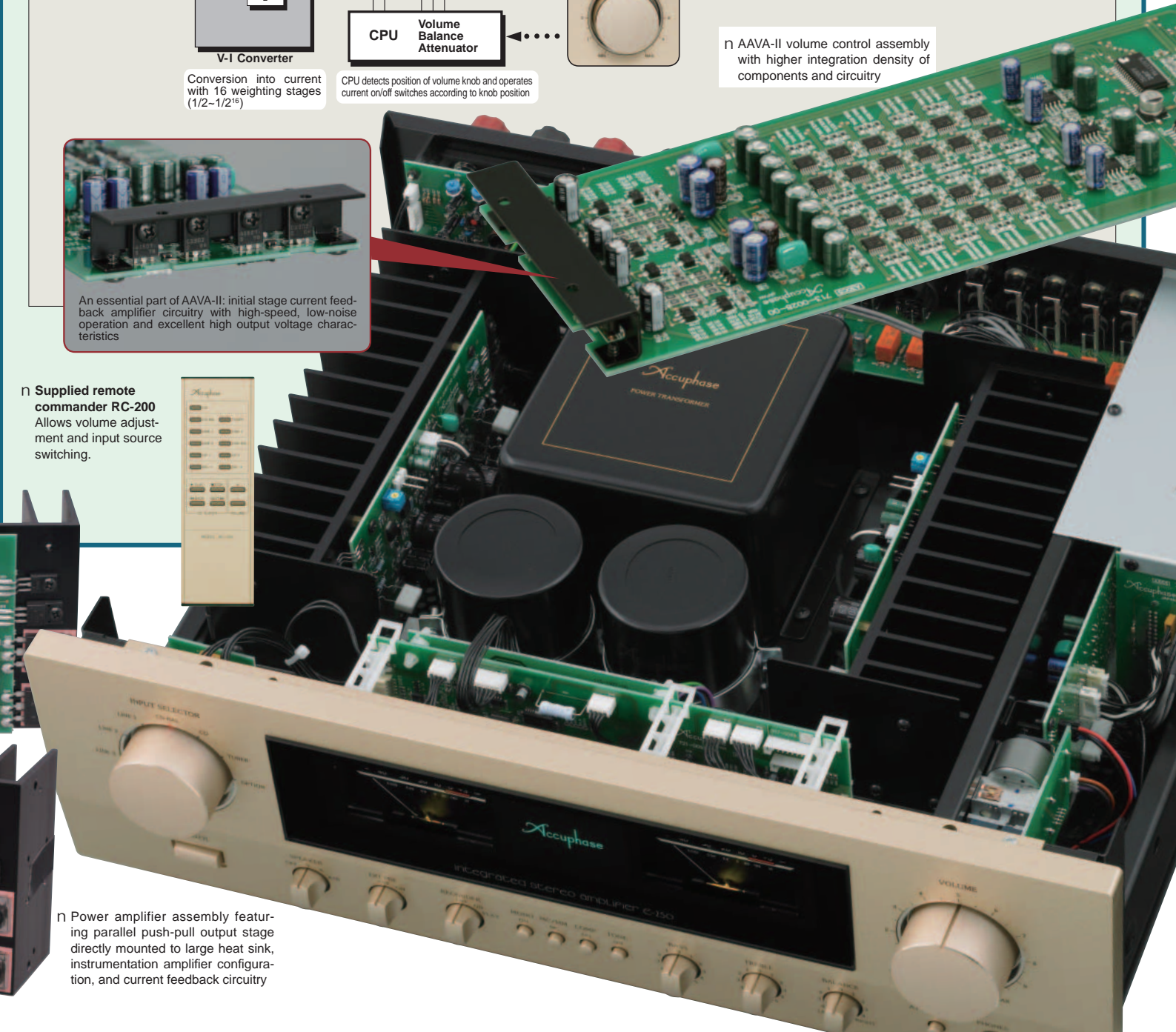

n **Tone controls using summing active filters for optimum sound quality**

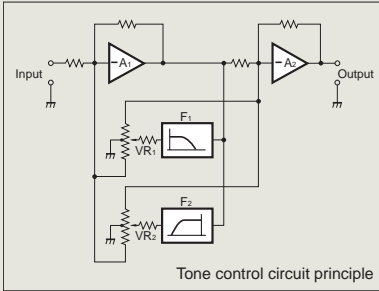

Tone control circuit principle

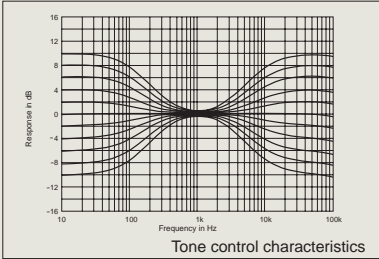

Tone control characteristics

## Option Boards

Three types of option boards can be used in the E-250: the Digital Input Board DAC-20, Analog Disc Input Board AD-20, and Line Input Board LINE-10. One of these boards can be installed in the rear-panel slot as required.

m The Analog Disc Input Board AD-9/AD-10 and the Line Input Board LINE-9 can also be used.

m When using the AD-9/AD-10, the MC/MM button of the E-250 has no effect. MC/MM switching must be performed on the board.

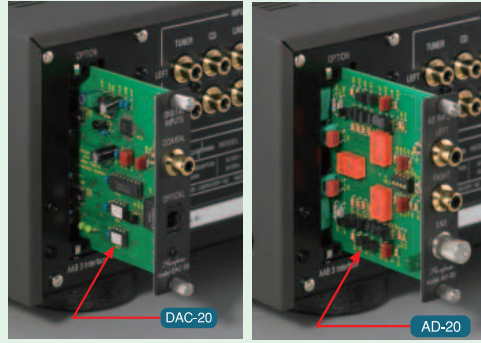

Photos show examples for option board installation.

### Digital Input Board

### DAC-20

The board features an MDS++ (Multiple Delta Sigma) type D/A converter and allows direct digital connection of a CD player, MD or other component with digital output (sampling frequency up to 96 kHz, 24 bits), for high-quality music reproduction.

m Inputs for coaxial and optical fiber connections are provided.

### Analog Disc Input Board

### AD-20

This board serves for playback of analog records. It contains a high-performance, high-gain phono equalizer.

m MC/MM switching is possible on the front panel of the E-250.

m Internal DIP switches control MC input impedance and subsonic filter on/off.

**MC** Gain : 62 dB  
Input impedance: 10/30/100 ohms (selectable)

**MM** Gain : 36 dB  
Input impedance: 47 kilohms

### Line Input Board

### LINE-10

This option board provides a set of unbalanced line level inputs.

## n Front Panel

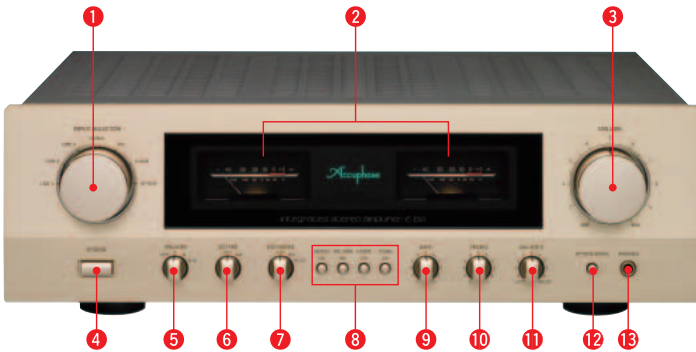

## n Rear Panel



- 1 Input selector  
LINE 3 LINE 2 LINE 1 CD-BAL CD  
TUNER OPTION
- 2 Left/right channel output meters
- 3 Volume control
- 4 Power switch
- 5 Speaker selector OFF A B A+B
- 6 EXT PRE (preamplifier/power amplifier separator) switch
- 7 Recorder switch OFF ON PLAY
- 8 Function buttons  
Stereo/Mono selection, MC/MM selection,  
Loudness compensator ON/OFF, Tone control ON/OFF
- 9 Bass control
- 10 Treble control
- 11 Balance control
- 12 Attenuator button
- 13 Headphone jack
- 14 Line inputs (unbalanced)
- 15 CD inputs (balanced)
- 16 Recorder outputs and inputs
- 17 Power amplifier inputs
- 18 Left/right speaker output terminals  
A/B
- 19 AC power connector\*

### Remarks

- \* This product is available in versions for 120/230 V AC. Make sure that the voltage shown on the rear panel matches the AC line voltage in your area.
- \* The shape of the AC inlet and plug of the supplied power cord depends on the voltage rating and destination country.

### n Supplied accessories:

- AC power cord
- Remote Commander RC-200

## GUARANTEED SPECIFICATIONS

[Guaranteed specifications are measured according to EIA standard RS-490.]

- m **Continuous Average Output Power** (both channels driven, 20 – 20,000 Hz)  
115 watts per channel into 4 ohms  
105 watts per channel into 6 ohms  
90 watts per channel into 8 ohms
- m **Total Harmonic Distortion** (both channels driven, 20 – 20,000 Hz)  
0.04% with 4 to 16-ohm load
- m **Intermodulation Distortion** 0.05%
- m **Frequency Response** HIGH LEVEL INPUT/POWER IN  
20 – 20,000 Hz +0, –0.2 dB (for rated continuous average output)  
3 – 150,000 Hz +0, –3.0 dB (for 1 watt output)
- m **Damping Factor** 100 (with 8-ohm load, 50 Hz)
- m **Input Sensitivity, Input Impedance**

Input	Sensitivity		Input impedance
	For rated output	For 1 W output (EIA)	
HIGH LEVEL INPUT	134 mV	14.2 mV	20 kΩ
BALANCED INPUT	134 mV	14.2 mV	40 kΩ
POWER IN	1.07 V	113 mV	20 kΩ

- m **Gain** HIGH LEVEL INPUT → OUTPUT: 46 dB  
POWER IN → OUTPUT: 28 dB
- m **Tone Controls** Turnover frequency and adjustment range  
BASS: 300 Hz ±10 dB (50 Hz)  
TREBLE: 3 kHz ±10 dB (20 kHz)
- m **Loudness Compensation** +6 dB (100 Hz)
- m **Attenuator** –20 dB
- m **Signal-to-Noise Ratio**

Input	Input shorted (A weighting)	EIA S/N
	S/N ratio at rated output	
HIGH LEVEL INPUT	105 dB	92 dB
BALANCED INPUT	89 dB	92 dB
POWER IN	120 dB	98 dB

- m **Power Level Meters** Logarithmic compression, peak reading meters  
Output dB/% scale
- m **Load Impedance** 4 – 16 ohms
- m **Stereo Headphones** Suitable impedance: 8 – 100 ohms
- m **Power Requirements** AC 120 V/230 V 50/60 Hz  
(Voltage as indicated on rear panel)
- m **Power Consumption** 46 watts idle  
245 watts in accordance with IEC 60065
- m **Maximum Dimensions** Width 465 mm (18-5/16")  
Height 150 mm (5-7/8")  
Depth 420 mm (16-9/16")
- m **Mass** 19.9 kg (43.9 lbs) net  
26 kg (57.3 lbs) in shipping carton
- m **Supplied Remote Commander RC-200**  
Remote control principle: Infrared pulse  
Power supply: 3 V DC (IEC R03 batteries x 2)  
Maximum dimensions: 56 mm x 175 mm x 26 mm  
Mass: 153 g (including batteries)



ACCUPHASE LABORATORY, INC.