

Accuphase

INTEGRATED STEREO AMPLIFIER

E-307

- Parallel push-pull output stage delivers 2 x 100 watts of quality power into 8 ohms
- Current feedback topology assures superb phase stability in the upper frequency range
- Logic-controlled relays for shortest signal paths
- Separate switch allows independent use of preamplifier and power amplifier
- Large, high-efficiency power transformer
- Digital input possible with option board
- Analog record playback possible with option board





Witness another revolution in sound. Integrated amplifier realizes digital input via option board with high-precision MDS (Multiple Delta Sigma) D/A converter. Current feedback topology assures superb high-range phase fidelity. Wide-band power transistors in parallel push-pull configuration and large power transformer deliver 140 watts/channel into 4 ohms and 100 watts/channel into 8 ohms.

Based on the highly successful Accuphase E-306V which has become a mainstay in the category of integrated amplifiers, the E-307 is a further enhanced and accomplished product for totally faithful music reproduction. It reflects the extensive experience Accuphase has gained in building superb separate-type amplifiers. Every single aspect has been honed to deliver optimum performance. An integrated amplifier provides various advantages such as convenient operation and modest space requirements. However, because its overall gain is very high, even the slightest interference or crosstalk at the input can have a considerable effect on the signal provided at the output. To preclude this possibility, the E-307 is built with totally separate preamplifier and power amplifier sections. Both electrically and structurally, these two parts operate completely autonomously. Each has its own power supply and dedicated regulator circuitry. A dedicated set of inputs and outputs even allows using the preamplifier and power amplifier as if they were stand-alone components.

Accuphase's highly acclaimed current feedback topology is used in both the preamplifier and power amplifier. This innovative principle eliminates phase shifts in the upper frequency range and assures stable operation and uniform frequency response which does not change with gain. Phase compensation can be kept at a minimum, and high amounts of negative feedback with their associated disadvantages are no longer required, resulting in excellent transient response, with superb sonic transparency and detail.

A total of six input positions are provided, including two balanced inputs for professional-quality noise-free signal transmission. The tape enthusiast will welcome connectors for two tape recorders, with easy dubbing in both directions. Tone controls, loudness compensation, and other convenient features come in handy. Flexibility is further enhanced by the option to install a Digital Input Board with a high-precision MDS (Multiple Delta Sigma) D/A converter that directly accepts the digital signal from a CD player or similar, for uncompromising reproduction quality. An analog disc input board is also available, allowing high-grade reproduction of analog records.

Parallel push-pull output stage delivers quality power: 140 watts/channel into 4 ohms, 100 watts/channel into 8 ohms

Figure 1 shows a circuit diagram of the power amplification stage. The power transistors are multi-emitter types designed for audio applications. They have been selected for optimum frequency response, forward-current transfer ratio linearity, and switching performance characteristics. Arranged to achieve low impedance, the devices are connected in parallel and mounted directly on a large heat sink for efficient dissipation of thermal energy. This allows the E-307 to deliver ample power output, amounting to 140 watts into 4 ohms, 120 watts into 6 ohms, or 100 watts into 8 ohms per channel.

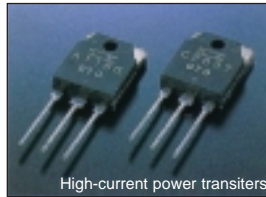

High-current power transistors

Current feedback circuit topology in power amplifier and preamplifier sections prevents phase shifts

In the E-307, the signal current rather than the more conventionally used voltage is used for feedback. Figure 2 shows the operating principle of this circuit. At the sensing point of the feedback loop, the impedance is kept low and current detection is performed. An impedance-converting amplifier then converts the current into a voltage to be used as the feedback signal. Since the impedance at the current feedback point (current adder in Figure 2) is very low, there is almost no phase shift. Phase

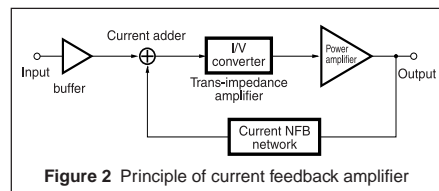

Figure 2 Principle of current feedback amplifier

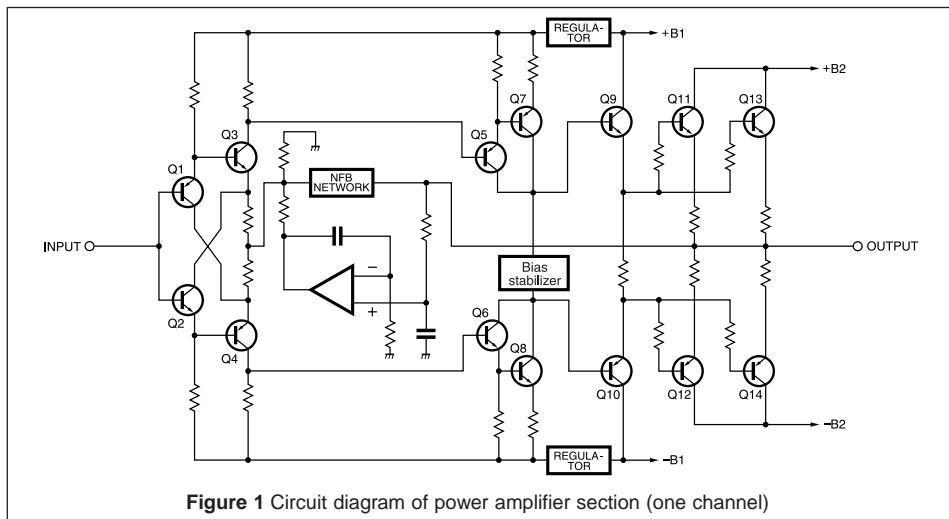

Figure 1 Circuit diagram of power amplifier section (one channel)

compensation can be kept to a minimum, resulting in excellent transient response and superb sonic transparency. Figure 3 shows frequency response for different gain settings of the current feedback amplifier. The graphs demonstrate that response remains uniform over a wide range.

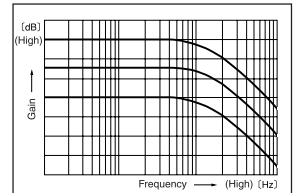
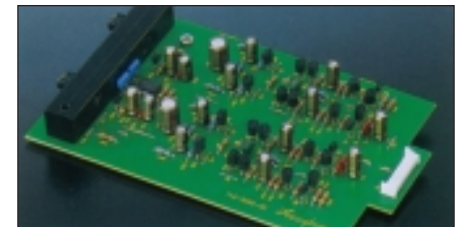

Fig. 3 Frequency response with current feedback (response remains uniform also when gain changes)

Figure 3 shows frequency response for different gain settings of the current feedback amplifier. The graphs demonstrate that response remains uniform over a wide range.

Discrete-type line amplifier for superior sonic purity

To assure optimum performance, the line amplifier is built entirely from discrete parts. A pure complementary push-pull circuit is used, and current feedback topology enhances circuit operation. This reduces the need for phase compensation, resulting in effortless, utterly natural and transparent sound.



Highly reliable logic-controlled relays

Program source switching is performed by logic-controlled relays which are arranged to permit the shortest possible signal paths. The hermetically sealed relays are high-quality types developed specifically for demanding communication applications. The contacts are twin crossbar types plated with gold for minimum contact resistance and outstanding long-term reliability.

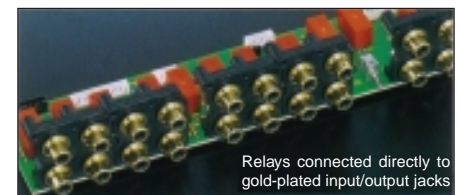

Relays connected directly to gold-plated input/output jacks

Tone controls use summing active filters for pure sound

The tone control circuitry in the E-307 was specially designed with summing active filters such as found in high-quality graphic equalizers. Figure 4 illustrates the operation principle of this circuit. The flat signal is passed straight through, and only when an adjustment is required, the characteristics are created at F1 and F2 and added to the signal,

thereby producing the desired change. This design provides efficient control without diluting signal purity.

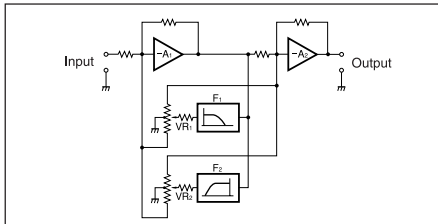
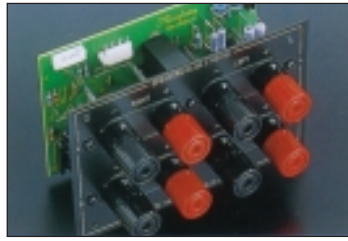

Figure 4 Tone control circuit principle (Summing active filter type)

Two sets of speaker terminals

The large speaker terminals are made of extruded high-purity brass material which accept also heavy-gauge speaker cable. Two sets of outputs with a speaker selector are provided, and bi-wiring (supplying the same signal via dual leads to

speakers with separate high-frequency and low-frequency inputs) is also possible.



Robust power supply with large power transformer and high filtering capacity

The power supply plays a vital role as the source of energy for the power amplifier section. The E-307 uses a large 500 VA power

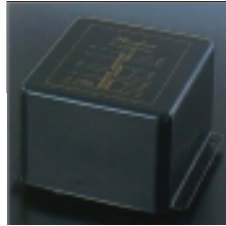

transformer and two massive electrolytic capacitors rated for 22,000 uF each. This assures ample reserves also for the reproduction of demanding bass passages. The preamplifier section which handles low-level signals has its own dedicated power supply circuitry to preclude any possibility of interference via the power supply line.



Large, direct-reading peak power meters

The large analog power meters have a peak hold function which lets you easily monitor the output level of the rapidly fluctuating music signal. Thanks to logarithmic compression, the meters cover a wide dynamic range.



- Power amplifier assembly with parallel push-pull output devices mounted to large heat sink and current feedback amplifier circuitry

- Supplied remote commander RC-20 allows volume adjustment and input source switching



Other Features

- Digital input can be implemented via option board.
- Analog phono input can be implemented via option board.
- High-quality volume control. Supplied remote commander allows source switching and volume adjustment.
- Separator switch and dedicated inputs/outputs enable independent use of preamplifier and power amplifier sections.
- Versatile input configuration including balanced connectors.

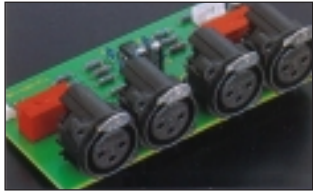

Option Boards

The rear panel of the E-307 provides two slots in which optional input boards can be installed easily. Three types of boards are available for the E-307: Digital Input Board DAC-10, Analog Input Board AD-10, and Line Input Board LINE-10.

- For reasons of power supply capacity, only one DAC-10 option board can be installed. Installing two AD-10 boards or a combination of DAC-10 and AD-10 is possible.
- The DAC-10 cannot be used in the models E-407, E-406V, E-306V, E-211, and C-265.
- The Analog Disc Input Board AD-9 and Line Input Board LINE-9 can also be used.

The option board shown in the photograph is the DAC-10



Digital Input Board

DAC-10

The board features an MDS (Multiple Delta Sigma) D/A converter and has inputs for coaxial and optical fiber connections. It assures high-quality reproduction of digital music signals (sampling frequency range 32 - 96 kHz, 24 bits).

Analog Disc Input Board

AD-10

This board contains a high-performance, high-gain phono equalizer. Internal DIP switches control MM/MC operation, MC input impedance, and subsonic filter on/off.

MM Gain: 36 dB
Input impedance: 47 kilohms

MC Gain: 62 dB
Input impedance: 10/30/100 ohms (selectable)

Line Input Board

LINE-10

This option board provides an additional set of conventional line inputs which can be used to connect a CD player, tuner, or other component with analog output.

FRONT PANEL

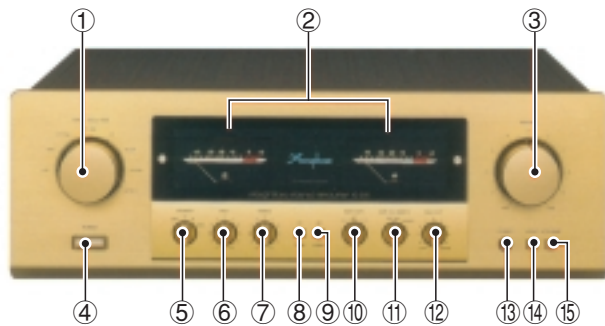

REAR PANEL

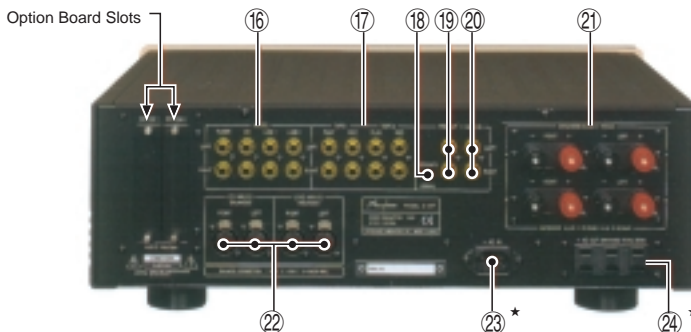

- | | |
|--|---|
| ① INPUT SELECTOR
LINE 2 LINE 1 LINE-BAL CD-BAL
CD TUNE OPTION 1 OPTION 2 | ⑫ BALANCE Control |
| ② Power Meters (Decibel Scale) | ⑬ PHONES Jack |
| ③ VOLUME Control | ⑭ MONO Switch |
| ④ POWER Switch | ⑮ ATT (Attenuator) Switch |
| ⑤ SPEAKER Selector OFF A B A+B | ⑯ INPUTS: TUNER, CD, LINE 1, 2 |
| ⑥ BASS Controls | ⑰ TAPE 1, 2 PLAY/REC Jacks |
| ⑦ TREBLE Controls | ⑱ Preamplifier/power amplifier separator switch |
| ⑧ TONE ON/OFF Button | ⑲ PRE OUT Jacks |
| ⑨ COMP (Loudness Compensator) Switch | ⑳ MAIN IN Jacks |
| ⑩ TAPE COPY Selector 1 → 2 OFF 2 → 1 | ㉑ SPEAKERS Terminals |
| ⑪ TAPE RECORDER Selector
REC OFF SOURCE 1 2 | ㉒ CD/LINE INPUTS (BALANCED) |
| | ㉓ AC Power Supply Connector
(for supplied power cord)* |
| | ㉔ SWITCHED Outlets* |

Remarks

- * This product is available in versions for 120/230 V AC. Make sure that the voltage shown on the rear panel matches the AC line voltage in your area.
- * The 230 V AC model does not have the SWITCHED power outlet.
- * The shape of the AC inlet, plug of the supplied power cord, and AC outlet depends on the voltage rating and destination country.
- * These switched AC outlets may not be supplied depending on the safety standards or regulations applicable in the particular country to where the unit is destined.

Supplied accessories: • AC power cord
• Remote commander RC-20

GUARANTEED SPECIFICATIONS

[Guaranteed specifications are measured according to EIA standard RS-490.]

- **Continuous Average Output Power** (both channels driven, 20 - 20,000 Hz)
140 watts per channel into 4 ohms
120 watts per channel into 6 ohms
100 watts per channel into 8 ohms
- **Total Harmonic Distortion** (both channels driven, 20 - 20,000 Hz)
0.01%, with 4 to 16 ohms load
- **Intermodulation Distortion**
0.01%
- **Frequency Response**
HIGH LEVEL INPUT/MAIN INPUT
20 - 20,000 Hz +0, -0.2 dB (for rated continuous average output)
2 - 150,000 Hz +0, -3.0 dB (for 1 watt output)
- **Damping Factor**
100 (with 8-ohm load, 50 Hz)
- **Input Sensitivity, Input Impedance**

Input	Sensitivity		Input impedance
	For rated output	For 1 W output (EIA)	
HIGH LEVEL INPUT	113 mV	11.2 mV	20 kΩ
BALANCED INPUT	113 mV	11.2 mV	40 kΩ
MAIN INPUT	1.13 V	112 mV	20 kΩ

- **Output Voltage, Output Impedance**
PRE OUTPUT: 1.13 V, 50 ohms
(at rated continuous average output)
- **Gain**
MAIN INPUT → OUTPUT: 28 dB
HIGH LEVEL INPUT → PRE OUTPUT: 20 dB
- **Tone Controls**
Turnover frequency and adjustment range
BASS: 300 Hz ±10 dB (50 Hz)
TREBLE: 3 kHz ±10 dB (20 kHz)
- **Loudness Compensation**
+6 dB (100 Hz) (Volume control setting -30 dB)
- **Attenuator**
-20 dB
- **Signal-to-Noise Ratio**

Input	Input shorted, IHF-A weighting		S/N ratio (EIA)
	S/N ratio at rated input		
HIGH LEVEL INPUT	104 dB		80 dB
BALANCED INPUT	88 dB		80 dB
MAIN INPUT	122 dB		100 dB

- **Power Level Meters**
Logarithmic compression, peak reading meters dB scale
- **Load Impedance**
4 - 16 ohms
- **Stereo Headphones**
Suitable impedance: 4 - 100 ohms
- **Power Requirements**
120 V/230 V (Voltage as indicated on rear panel) AC, 50/60 Hz
- **Power Consumption**
50 watts idle
240 watts in accordance with IEC-65
- **Maximum Dimensions**
Width 475 mm (18-11/16")
Height 170 mm (6-11/16")
Depth 424 mm (16-11/16")
- **Weight**
21.6 kg (47.6 lbs) net
26.0 kg (57.3 lbs) in shipping carton