



GFP-750

Stereo Preamplifier

OWNER'S MANUAL

THE FOLLOWING PRECAUTIONS AND SAFETY INSTRUCTIONS ARE REQUIREMENTS OF UL AND CSA SAFETY REGULATIONS

Warning: To reduce the risk of fire or electric shock, do not expose this unit to rain or moisture.

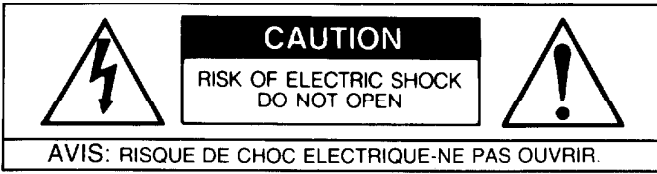

The graphic symbol of a lightning flash with an arrow point within a triangle signifies that there is dangerous voltage within the unit and it poses a hazard to anyone removing the cover to gain access to the interior of the unit. **Only qualified service personnel should make any such attempt.**



The graphic symbol of an exclamation point within an equilateral triangle warns a user of the device that it is necessary to refer to the instruction manual and its warnings for proper operation of the unit.



Do not place this unit on an unstable cart, stand, tripod, bracket, or table. The unit may fall, causing serious injury to a child or adult, and serious damage to the unit. Use only with a cart, stand, tripod, bracket, or table recommended by the manufacturer, or sold with the unit. Any mounting of the device should follow the manufacturer's instructions, and should use a mounting accessory recommended by the manufacturer.

Read all the safety and operating instructions before connecting or using this unit.

Retain this notice and the owner's manual for future reference.

All warnings on the unit and in its operating instructions should be adhered to.

All operating and use instructions should be followed.

Do not use this unit near water; for example, near a bathtub, washbowl, kitchen sink, laundry tub, in a wet basement, or near a swimming pool.

The unit should be installed so that its location or position does not interfere with its proper ventilation. For example, it should not be situated on a bed, sofa, rug, or similar surface that may block the ventilation openings; or placed in a built-in installation, such as bookcase or cabinet, that may impede the flow of air through its ventilation openings.

The unit should be situated away from heat sources such as radiators, heat registers, stoves, or other devices (including amplifiers) that produce heat.

The unit should be connected to a power-supply outlet only of the voltage and frequency marked on its rear panel.

The power-supply cord should be routed so that it is not likely to be walked on or pinched, especially near the plug, convenience receptacles, or where the cord exits from the unit.

Clean unit only as recommended in its instruction manual.

The power-supply cord of the unit should be unplugged from the wall outlet when it is to be unused for a long period of time.

Care should be taken so that objects do not fall, and liquids are not spilled, into the enclosure through any openings.

This unit should be serviced by qualified service personnel when:

- A. The power cord or the plug has been damaged; or
- B. Objects have fallen, or liquid has been spilled, into the unit; or
- C. The unit has been exposed to rain, or liquids of any kind; or
- D. The unit does not appear to operate normally, or exhibits a marked change in performance; or
- E. The device has been dropped, or the enclosure damaged.

ATTENTION

POUR PRÉVENIR LES CHOCS ÉLECTRIQUES NE PAS UTILISER CETTE FICHE POLARISÉE AVEC UN PROLONGATEUR, UNE PRISE DE COURANT OU UNE AUTRE SORTIE DE COURANT, SAUF SI LES LAMES PEUVENT ÊTRE INSÉRÉES À FOND SANS EN LAISSER AUCUNE PARTIE À DÉCOUVERT.

CAUTION

TO PREVENT ELECTRIC SHOCK DO NOT USE THIS POLARIZED PLUG WITH AN EXTENSION CORD, RECEPTACLE OR OTHER OUTLET UNLESS THE BLADES CAN BE FULLY INSERTED TO PREVENT BLADE EXPOSURE.

CAUTION

POWER LINES

Any outdoor antenna must be located away from all power lines.

OUTDOOR ANTENNA GROUNDING

If an outside antenna is connected to your tuner or tuner-preamplifier, be sure the antenna system is grounded so as to provide some protection against voltage surges and built-up static charges. Section 810 of the National Electrical Code, ANSI/NFPA No. 70-1984, provides information with respect to proper grounding of the mast and supporting structure, grounding of the lead-in wire to an antenna discharge unit, size of grounding conductors, location of antenna discharge unit, connection to grounding electrodes, and requirements for the grounding electrode.

- a. Use No.10 AWG (5.3 mm²) copper, No.8 AWG (8.4 mm²) aluminum, No.17 AWG (1.0 mm²) copper-clad steel or bronze wire, or larger, as a ground wire.
- b. Secure antenna lead-in and ground wires to house with stand-off insulators spaced from 4-6 feet (1.22-1.83 m) apart.
- c. Mount antenna discharge unit as close as possible to where lead-in enters house.
- d. Use jumper wire not smaller than No.6 AWG (13.3 mm²) copper, or the equivalent, when a separate antenna-grounding electrode is used. See NEC Section 810-21 (j).

EXAMPLE OF ANTENNA GROUNDING AS PER NATIONAL ELECTRICAL CODE INSTRUCTIONS CONTAINED IN ARTICLE 810 - RADIO AND TELEVISION EQUIPMENT.

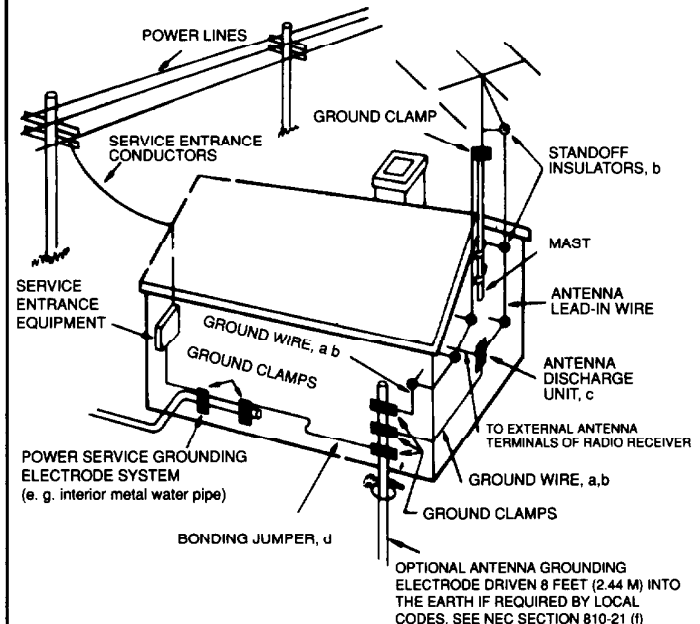

NOTE TO CATV SYSTEM INSTALLER

This reminder is provided to call the CATV system installer's attention to Article 820-22 of the National Electrical Code that provides guidelines for proper grounding and, in particular, specifies that the cable ground shall be connected to the grounding system of the building, as close to the point of cable entry as practical.

**DO NOT ATTEMPT SERVICING OF THIS UNIT YOURSELF.
REFER SERVICING TO QUALIFIED SERVICE PERSONNEL.**

1. PRODUCT DESCRIPTION

1.1. GFP-750 Front Panel Diagram & Remote Control

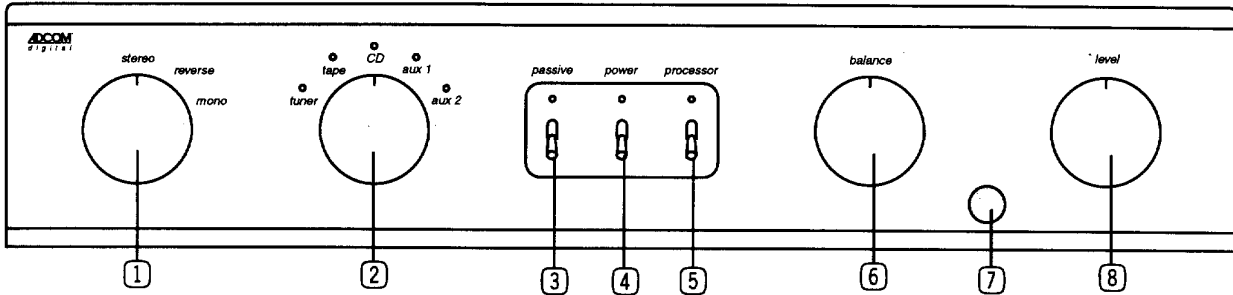

- ① **Stereo/Reverse/Mono** Switch (*reverse*) or combine (*mono*) channels
- ② **Input Source Selection** Select input source
- ③ **Passive Mode On/Off** Bypass active gain stages
- ④ **Power On/Off** Turn unit on and off.
- ⑤ **External Processor** Engage external processor
- ⑥ **Balance Control** Adjust balance level
- ⑦ **Infrared Remote Control Sensor Lens** Receiver for remote control IR signal
- ⑧ **Volume Control** Adjust volume level
- ⑨ **Mute** Engage Mute circuitry

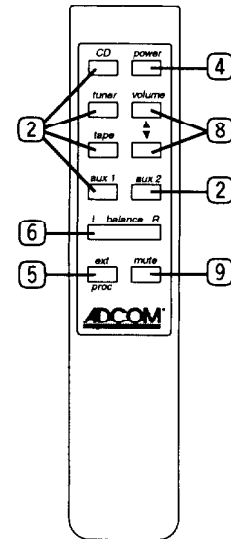

1.2. GFP-750 Rear Panel Diagram

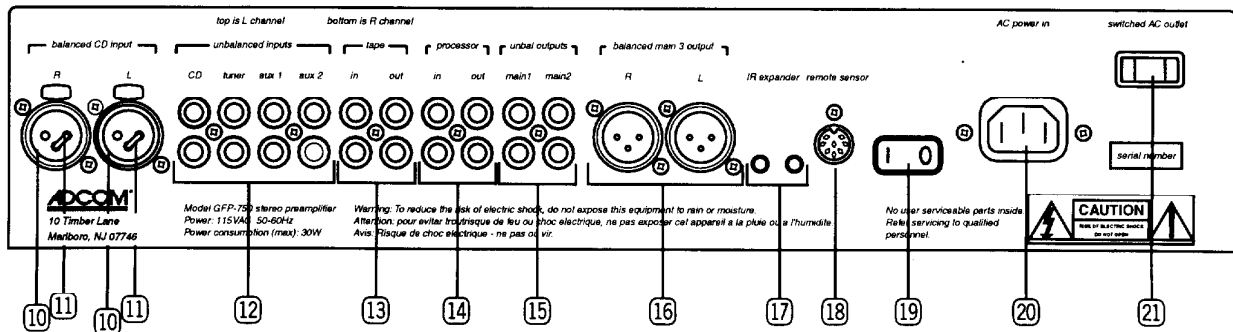

- ⑩ CD Balanced Inputs
- ⑪ Gold Jumpers
- ⑫ Unbalanced Stereo Inputs
- ⑬ Tape Loop Stereo In/Out
- ⑭ External Processor Loop Stereo In/Out
- ⑮ Main 1 and Main 2 Unbalanced Stereo Outputs
- ⑯ Main 3 Balanced Stereo Outputs
- ⑰ Remote Control Infrared repeater outputs (x 2)
- ⑱ Remote Control Sensor Input
- ⑲ Master On/Off Switch
- ⑳ AC Power Cord Socket
- ㉑ Switched AC Outlet

1.3. Product Features

① Stereo/Reverse/Mono Switch

This switch is used to change the polarity of the input signal in relation to the output signal. The stereo setting allows normal playback of the input signal. The reverse setting inverts the phase of the input signal. The mono setting combines both channels for a monaural input signal or where speaker placement does not accommodate stereo playback.

② Input Selection

The input selection knob has a digital interface that senses movement of the knob. The knob appears to turn freely as the interface detects the direction the knob is being turned and indexes through the input sources accordingly. To go from *aux 2* to *tuner* or from *tuner* to *aux 2*, you must index back through the other input sources.

③ Passive

This feature allows the active gain stages of the preamp to be bypassed. (*A slight drop in volume level is expected when this feature is engaged.*) This feature has no effect when the *processor* feature is engaged.

④ Power On/Off

The **GFP-750** is turned on by pressing either the remote control *power* button or toggling the front panel *power* switch. The LED above the *power* switch will come on indicating the unit is on. (The *power* status LED will glow slightly dimmer when the unit is muted.)

⑤ Processor Switch

Engages the processor loop when activated. See ⑭ for further information.

⑥ Balance Control

The **GFP-750** balance control feature provides finer balance adjustment allowing for greater balance accuracy and will not entirely mute either channel.

⑦ Infrared Remote Control Sensor Lens

This lens protects the infrared receiver which receives commands from the remote control. The pathway between the lens and remote control must be free of obstructions for the remote control to operate the **GFP-750**.

⑧ Volume Control

The front panel *volume* control knob is motorized. It may be adjusted either by hand or by the *volume* buttons on the remote control. The *volume* knob's groove always indicates the present volume level. The *volume* control knob may be used to reduce the volume level while the **GFP-750** is muted without deactivating the mute feature.

⑨ Mute

The **GFP-750's** mute feature is engaged by pressing the *mute* button on the remote control. This feature fully mutes the outputs. To deactivate the mute feature, press the *mute* button again or either of the two *volume* buttons on the remote control. (*Turning the front panel volume knob will not deactivate the mute feature.*)

⑩ Balanced CD Inputs

Before using the balanced CD inputs, it is necessary to remove the gold jumpers located between pins 1 and 3 in both connectors. (See the figure to the right.) When switching from balanced CD inputs to unbalanced CD inputs, you must replace the jumpers between pins 1 and 3 as shown.

DO NOT USE BOTH BALANCED AND UNBALANCED CD INPUTS AT THE SAME TIME.

⑪ Gold Jumpers

When using the unbalanced CD inputs, jumpers must be installed to short pins 1 and 3 of the balanced input jacks.

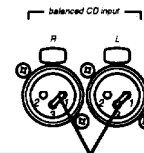

gold jumpers

⑫ Unbalanced Stereo Inputs

Connect the various outputs from each signal source to these unbalanced stereo inputs. *Do not connect both the unbalanced and balanced CD inputs at the same time.* See the section labeled **CONNECTIONS** for further information regarding these inputs.

13 Tape In/out

The *tape* outputs are fixed level outputs. The signal is selected by the *input source* knob or *input* buttons on the remote control. (*The tape outputs are muted when tape is selected as the input source or when the processor loop is engaged.*)

14 Processor

The processor in/out connectors allow for convenient connection of an external processor, like ADCOM's **GSA-700 surround** sound processor. The connection diagrams under Audio/Home Theater and Multi-Channel Audio detail basic connection methods that take advantage of this feature. When the processor feature is activated the external processor controls the volume and balance of the system.

15 Main Unbalanced Stereo Outputs

Main 1 is an unbalanced line level stereo output to be connected to the amplifier's unbalanced inputs. *Main 2* accommodates a second amplifier for multi-room or multi-zone operation.

16 Main Balanced Stereo Outputs

Main 3 is a balanced line level stereo output for use with amplifiers that utilize balanced inputs.

17 Remote Control Infrared Repeater Output

Connect the ADCOM IRA-500II infrared repeater to control other remote controlled equipment via the remote sensor extension.

18 Remote Control Sensor Input

Connect either the ADCOM XR-500II or SPM-500II to extend the remote control capabilities of the GFP-750 via an external room or zone.

19 Master On/Off Switch

The rear panel Master On/Off Switch allows the unit to be electrically disconnected from the AC power source without having to remove the AC power cord. We recommend the Master On/Off switch be pushed to the "O" (off) position when the unit will be left unattended for an extended period of time.

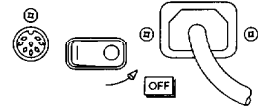

IF THE GFP-750 DOES NOT RESPOND TO REMOTE CONTROL COMMANDS, AND THE AC POWER CORD IS INSTALLED, CHECK THAT THE MASTER ON/OFF SWITCH IS IN THE "I" ON POSITION.

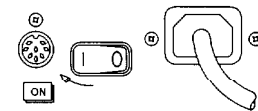

2. CONNECTIONS

2.1. Connecting the GFP-750

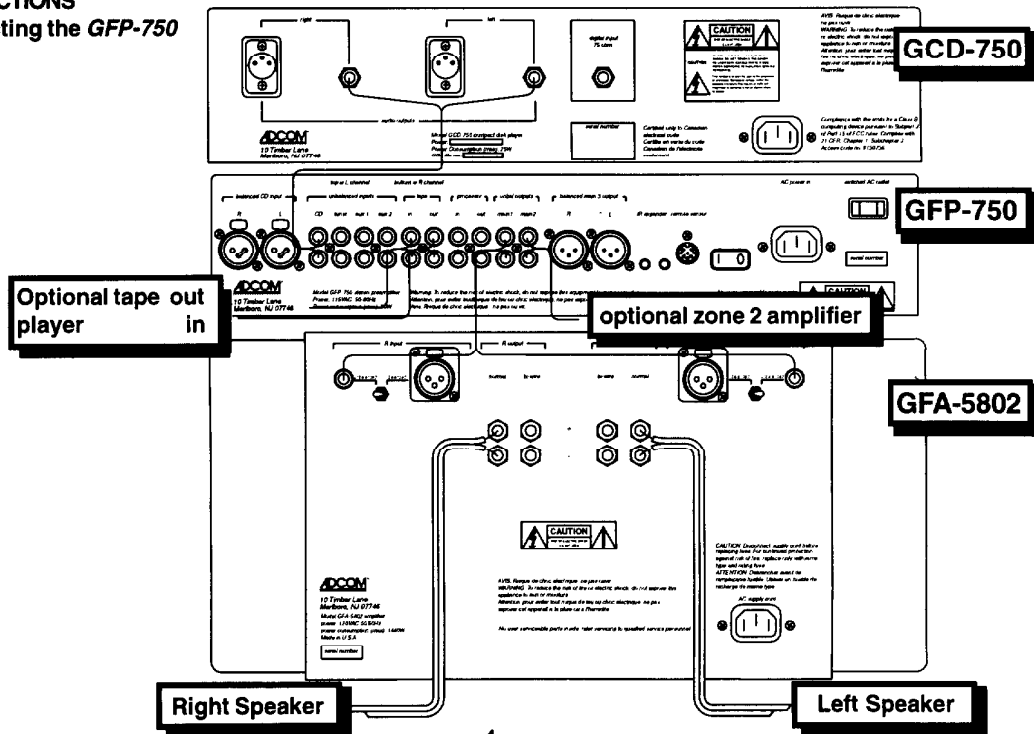

2.2. Adding an External Processor

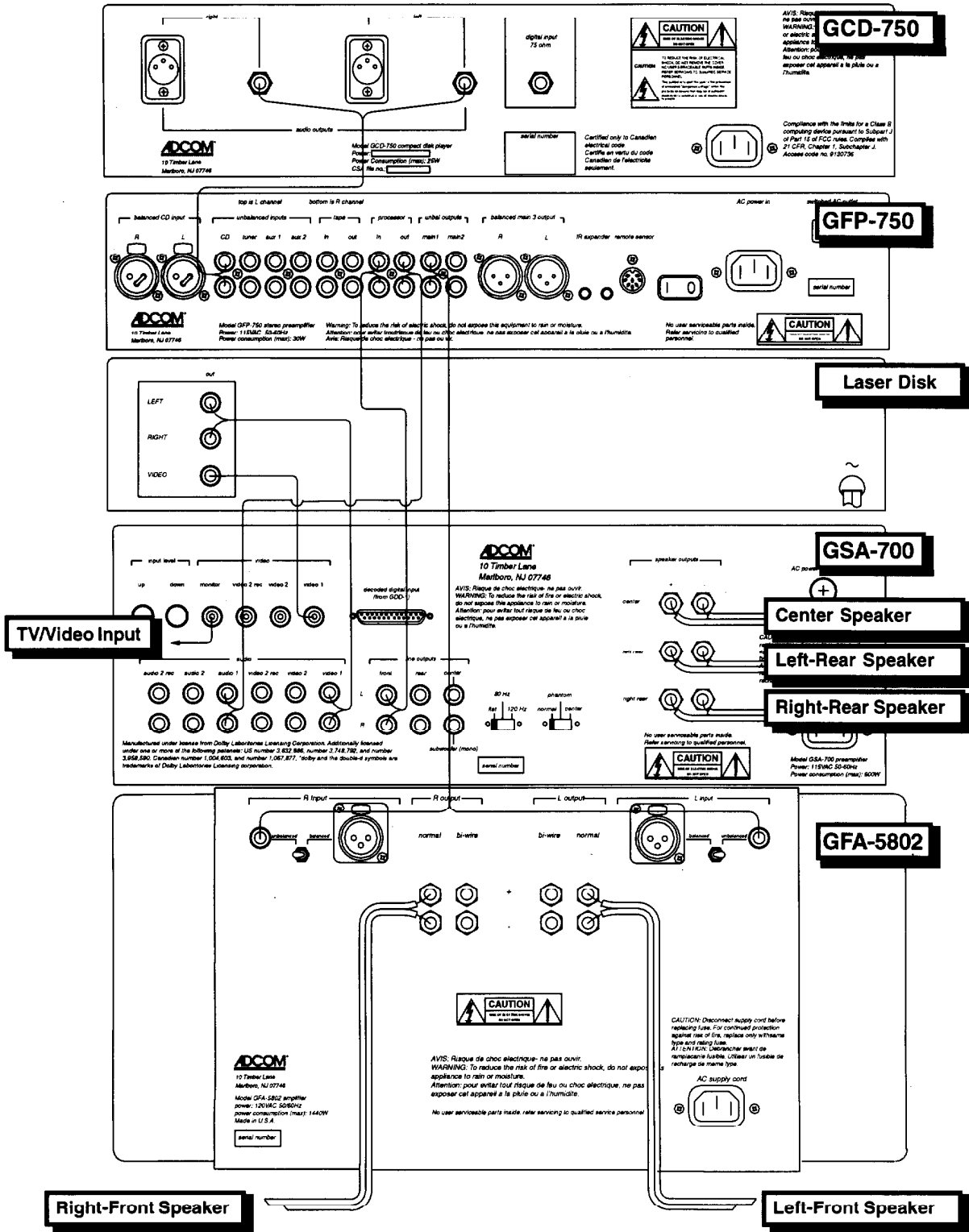

Note: These diagrams represent a basic audio/video system using the GFP-750 with various other audio equipment. Additional audio and video sources may easily be added to the system following similar connections as shown. Refer to your other owner's manuals for more detailed connection information.

3. TROUBLE SHOOTING

Symptoms	Possible Causes
Unit does not respond to front panel <i>power</i> switch or remote control <i>power</i> button.	-AC power cord not connected -Master On/Off switch is off
<i>Power</i> LED is dimmer than the other status LED's.	-Preamp is muted. (<i>Power</i> LED is dimmed when outputs are muted.)
No signal at <i>main</i> outputs	-Wrong source selected -The external processor feature is activated (<i>processor</i> LED is on) without the external processor either being on or connected properly. (The main outputs are connected to the <i>processor in</i> inputs when in the external processor feature is activated.) -Preamp is muted. (<i>Power</i> LED is dimmed when outputs are muted.)
No signal at <i>tape</i> outputs	-The input device is on <i>tape</i> . -The external processor feature is activated. (<i>Processor</i> LED is on) (<i>tape out</i> is disconnected when <i>tape</i> is selected as the source or the <i>processor</i> feature is activated.)
Volume level is reduced when going to passive mode	-A slight reduction in volume level is to be expected as the active gain stages are bypassed when the <i>passive</i> feature is engaged.
The <i>volume</i> and <i>balance</i> controls do not function.	-The <i>volume</i> and <i>balance</i> controls are bypassed when the <i>processor</i> feature is engaged. Either use the controls on the external processor or switch the <i>processor</i> feature off.

4. CARE AND MAINTENANCE

The *GFP-750*'s steel chassis and extruded aluminum front panel are specially coated to provide a durable and attractive finish. To remove dust and finger smudges, merely dampen a cloth and wipe off the chassis. Do not use strong solvents or detergents. Many are very abrasive or corrosive. Never spray or pour any liquid onto the chassis or front panel. In the event of any liquid getting into the chassis, unplug the unit from the AC outlet immediately.

5. SERVICING

ADCOM's Technical Service Department will be happy to answer all questions pertaining to the installation and operation of your unit. In the unlikely event of difficulty, please contact us for prompt advice. If we cannot help you resolve the problem immediately, we may refer you to an authorized repair agency, or authorize the return of your unit to our plant.

All written inquiries should be addressed to:

ADCOM Service Department
10 Timber Lane
Marlboro, NJ 07746 USA
(732) 683-2356 Phone (732) 683-9792 Fax

Telephone inquiries are welcome from Monday through Friday between 9 AM and 4 PM, Eastern Standard Time. We will also be glad to answer any FAX inquiries. Please include your phone and FAX numbers so we can respond.

When inquiring about your unit, please include the serial number, the name of the dealer from whom you purchased the unit, and the date of purchase.

If we ask you to return the unit to us for service, we will issue a specific Return Authorization number for your use. UNDER NO CIRCUMSTANCES SHOULD THE UNIT BE SHIPPED TO US WITHOUT PROPER AUTHORIZATION OR PACKED IN ANYTHING OTHER THAN ITS ORIGINAL PACKING.

If the original packing has been lost, discarded or damaged, we will gladly supply replacement packaging at a nominal charge. Please mention your need when you contact us.

Always ship PREPAID via UPS (United Parcel Service) or other appropriate carrier. FREIGHT COLLECT SHIPMENTS WILL BE REFUSED.

DO NOT SHIP VIA PARCEL POST as the packaging will not necessarily withstand the handling by our Postal Service.

6. GFP-750 SPECIFICATIONS

Output Level (Rated) 1.0V

THD+N @ Rated Output (20Hz to 20kHz)

Balanced..... ≤0.025%
Unbalanced ≤0.095%

THD+N @ Rated Output (1kHz)

Balanced..... ≤0.015%
Unbalanced ≤0.017%

Output Impedance

Balance..... <1200Ω
Unbalanced Outputs..... <600Ω

Input Impedance

Balanced..... 94kΩ
Unbalanced 47kΩ

Frequency Response (Balanced and Unbalanced)

20Hz to 20kHz +0, -0.25dB

IM Distortions (@ Rated Output)

CCIF from 4kHz to 20kHz (Balanced) ≤0.009%
CCIF from 4kHz to 20kHz (Unbalanced) ≤0.035%
SMPTE (Balanced) ≤ 0.05%
SMPTE (Unbalanced)..... ≤ 0.05%

Signal to Noise Ratio (Ref. to 1 volt)

"A" Weighted (Balanced) ≥102dB
"A" Weighted (Unbalanced) ≥102dB

Input Sensitivity (@ Rated Output)

Balanced..... 183mV
Unbalanced 365mV

GENERAL SPECIFICATIONS

Power (available in 230V by special order) 115VAC-50/60Hz
Power Consumption 30 VA
Chassis Dimensions 3 1/2" (89mm) x 17" (432mm) x 11" (279mm)
Maximum Dimensions 4 1/8" (105mm) x 17" (432mm) x 12"(305mm)
Weight 15 lbs (6.8kg)
Weight, Packed 17 lbs. (7.7kg)