

---

# AKAI

## SECTION 1

### STEREO PRE AMPLIFIER

# MODEL UC-A5

ALSO APPLICABLE TO BLACK PANEL MODEL

#### TABLE OF CONTENTS

I.	TECHNICAL DATA .....	4
II.	DISMANTLING OF UNIT .....	5
III.	CONTROLS .....	6
IV.	PRINCIPAL PARTS LOCATION .....	7
V.	VOLTAGE CONVERSION .....	8
VI.	ADJUSTMENT .....	9
VII.	CLASSIFICATION OF VARIOUS P.C BOARDS .....	10
	1. P.C BOARD TITLE AND IDENTIFICATON NUMBERS .....	10
	2. COMPOSITION OF VARIOUS P.C BOARDS .....	11

## V. VOLTAGE CONVERSION

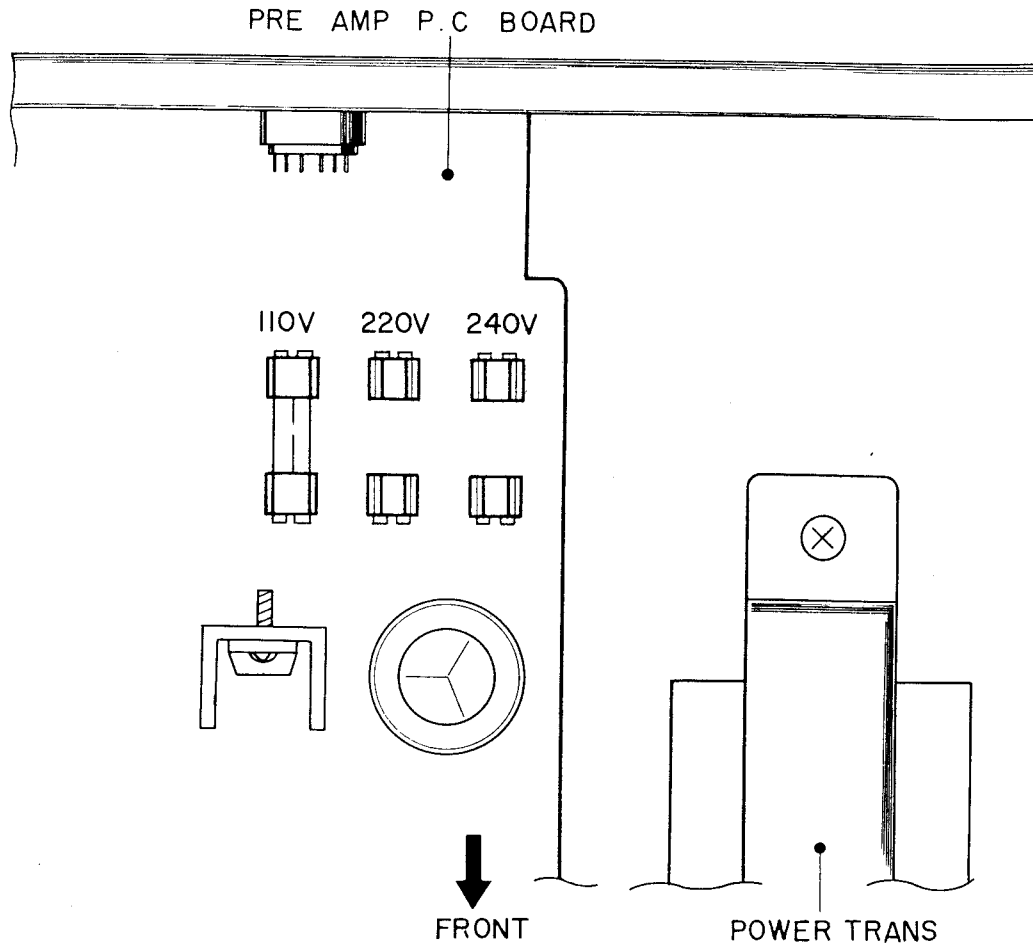

Fig. 3 Voltage Conversion (U/T Model)

### 1. U/T Model (Refer to Fig. 3)

- 1) Switch OFF power and remove power cord from mains supply.
- 2) Loosen holding screws and remove bottom panel.
- 3) Remove existing Line Voltage Fuse and insert required Line Voltage Fuse in the proper fuse holder.
  - 110 V : 500 mA
  - 220 V : 250 mA
  - 240 V : 250 mA

### 2. Models other than U/T

No voltage conversion.

## VI. ADJUSTMENT

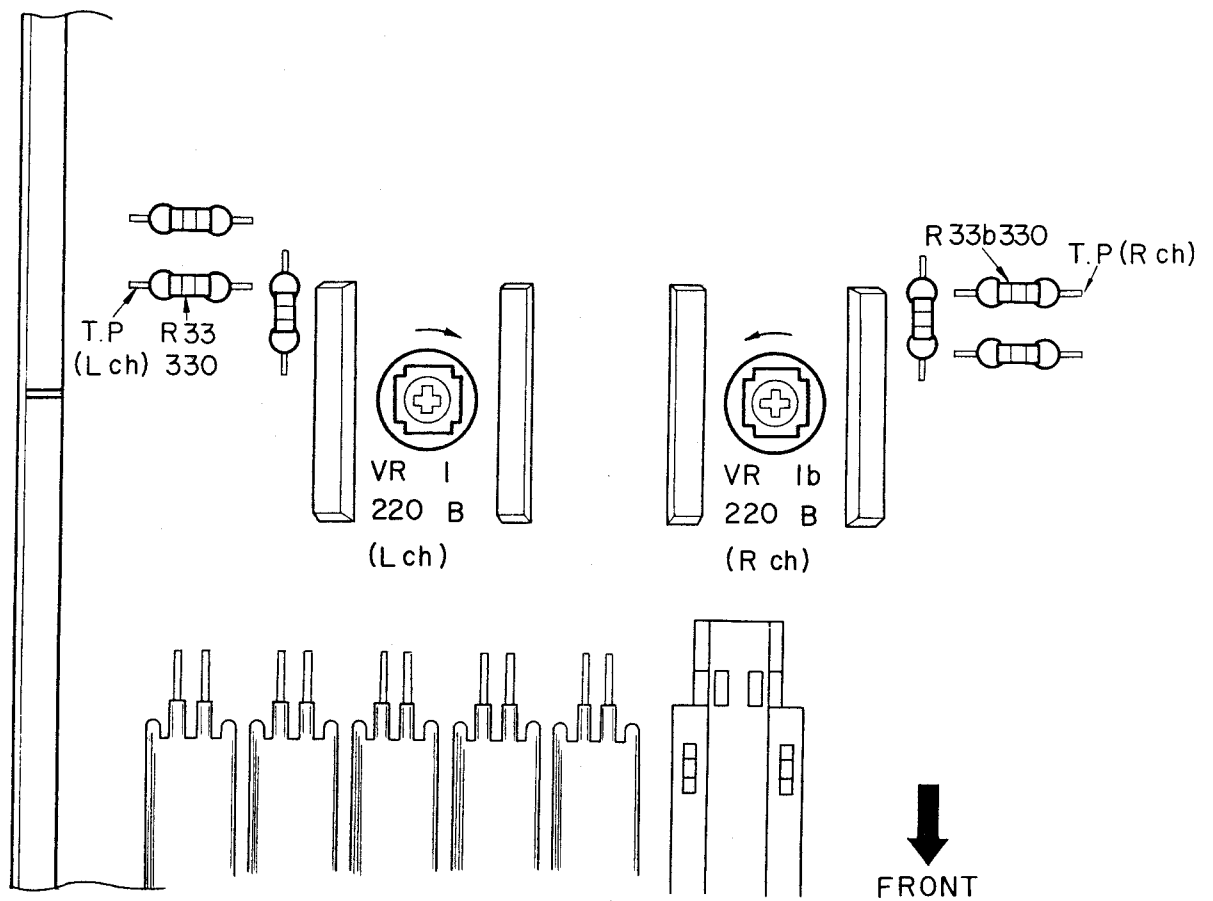

Fig. 4 Adjustment Points

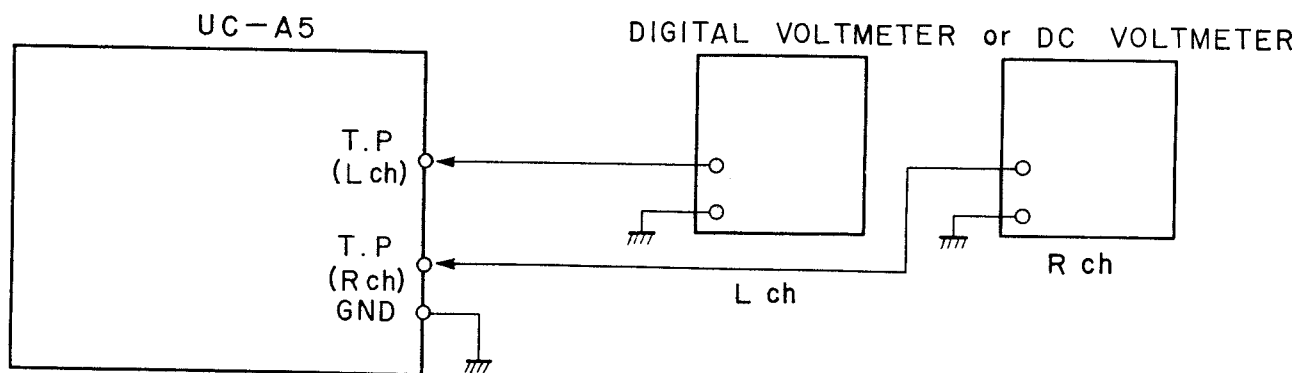

Fig. 5 Instrument Connections

### 1. CENTER OFF-SET VOLTAGE ADJUSTMENT (Refer to Figs. 4, 5)

Connect the Digital Voltmeter or DC Voltmeter between T.P. and Ground. Adjust the VR 1 (220 B) so that Voltmeter reading is  $0 \pm 50$  mV.

## 2. COMPOSITION OF VARIOUS P.C BOARDS

### PRE AMP P.C BOARD UCA-5001 (2ED) and INPUT P.C BOARD UCA-5002

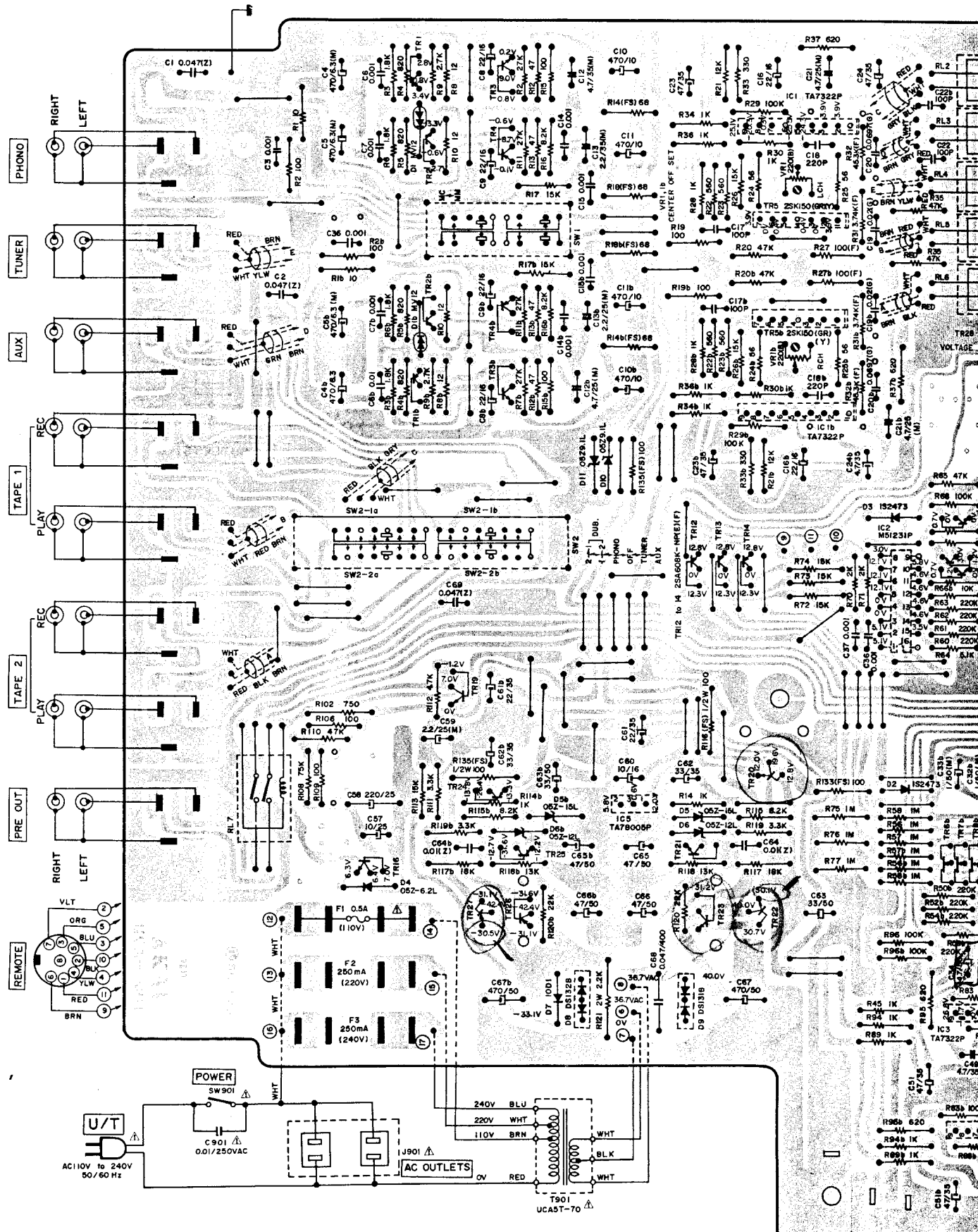

WARNING: Δ INDICATES SAFETY CRITICAL COMPONENTS. FOR CONTINUED SAFETY, REPLACE SAFETY CRITICAL COMPONENTS ONLY WITH MANUFACTURER'S RECOMMENDED PARTS

AVERTISSEMENT: Δ IL INDIQUE LES COMPOSANTS CRITIQUES DE SÛRETÉ. POUR MAINTENIR LE NIVEAU DE SÛRETÉ DE L'APPAREIL, NE REMPLACER LES COMPOSANTS DONT LE FONCTIONNEMENT EST CRITIQUE POUR LA SÛRETÉ QUE PAR DES PIÈCES RECOMMANDÉES PAR LE FABRICANT

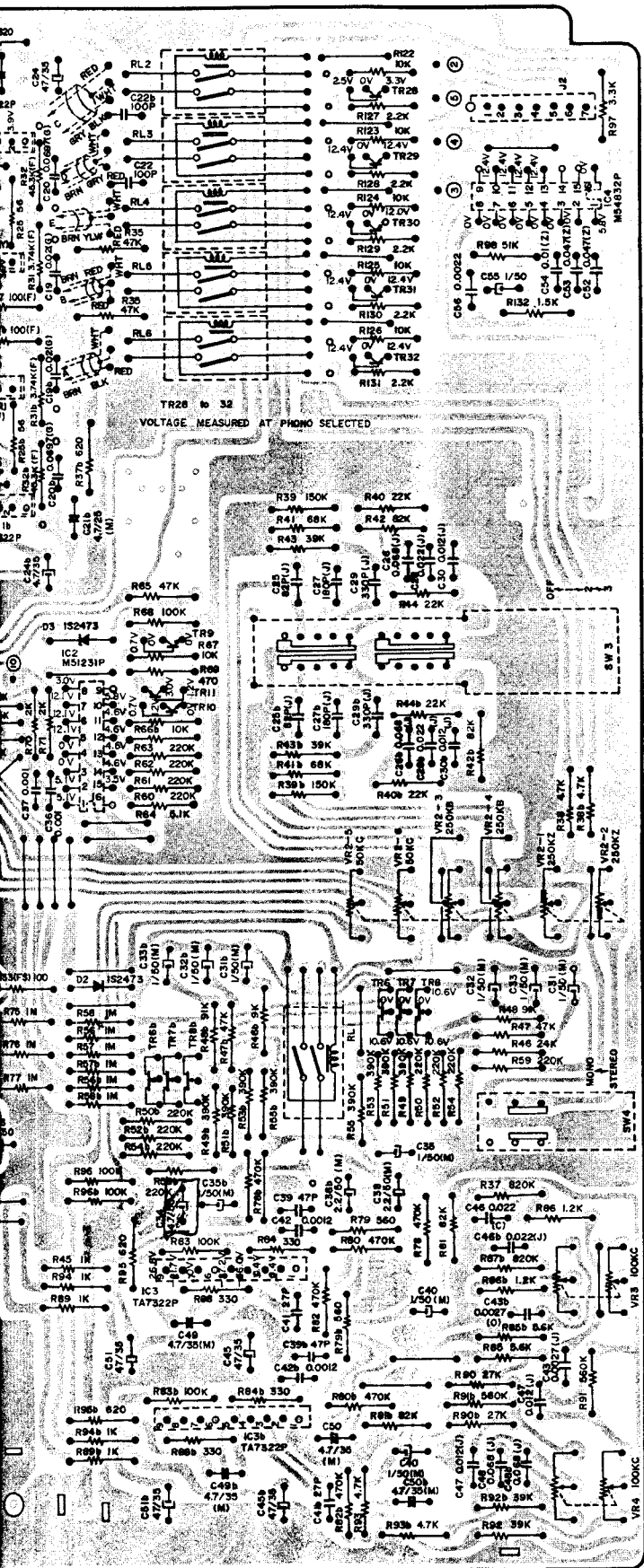

PRE AMP P.C BOARD UCA-5001

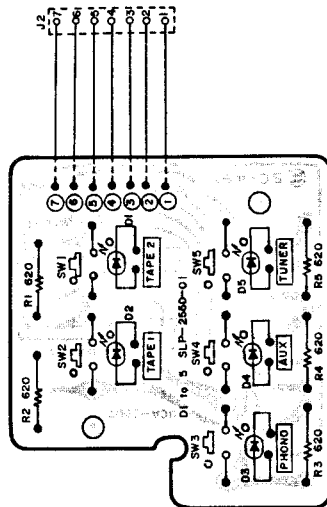

INPUT P.C BOARD CUA-5002

SW1  
CARTRIDGE

SW2  
REC SELECTOR

SW3  
LOUDNESS

SW4  
BALANCE

SW5  
VOLUME

SW6  
MODE

SW7  
TREBLE

SW8  
BASS



2SD612K



2SB560



2SD438



2SK30A

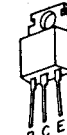

2SA608-NP

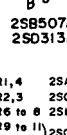

2SA970

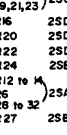

2SC536K-NP



2SC2240



2SB507AL

- TR1,4 2SA970(GR)(BL)
- TR2,3 2SC2240(GR)(BL)
- TR6 to 8 2SK30A(Y)(GR)
- TR9 to 11 2SC536K-NP(E)(F)
- 15,21,23
- TR16 2SD438(E)(F)
- TR20 2SD612K(E)(F)
- TR22 2SD313AL(D)(E)(F)
- TR24 2SB560(E)(F)
- TR12 to 26 2SA608K-NP(E)(F)
- TR27 2SB507AL(D)(E)(F)

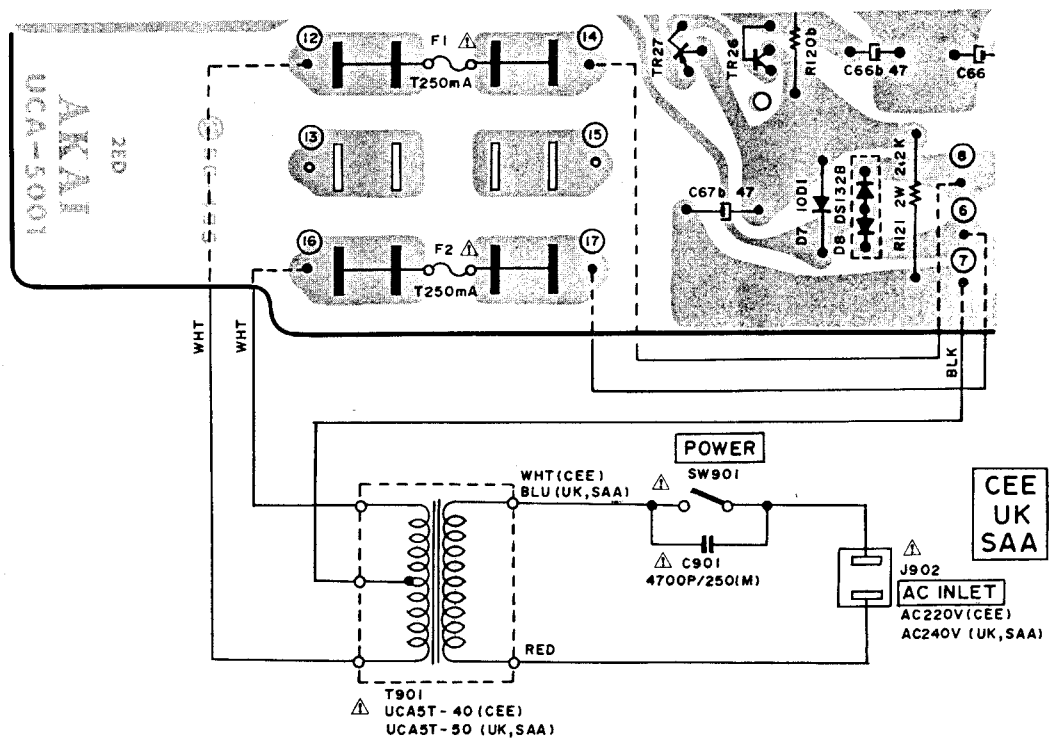
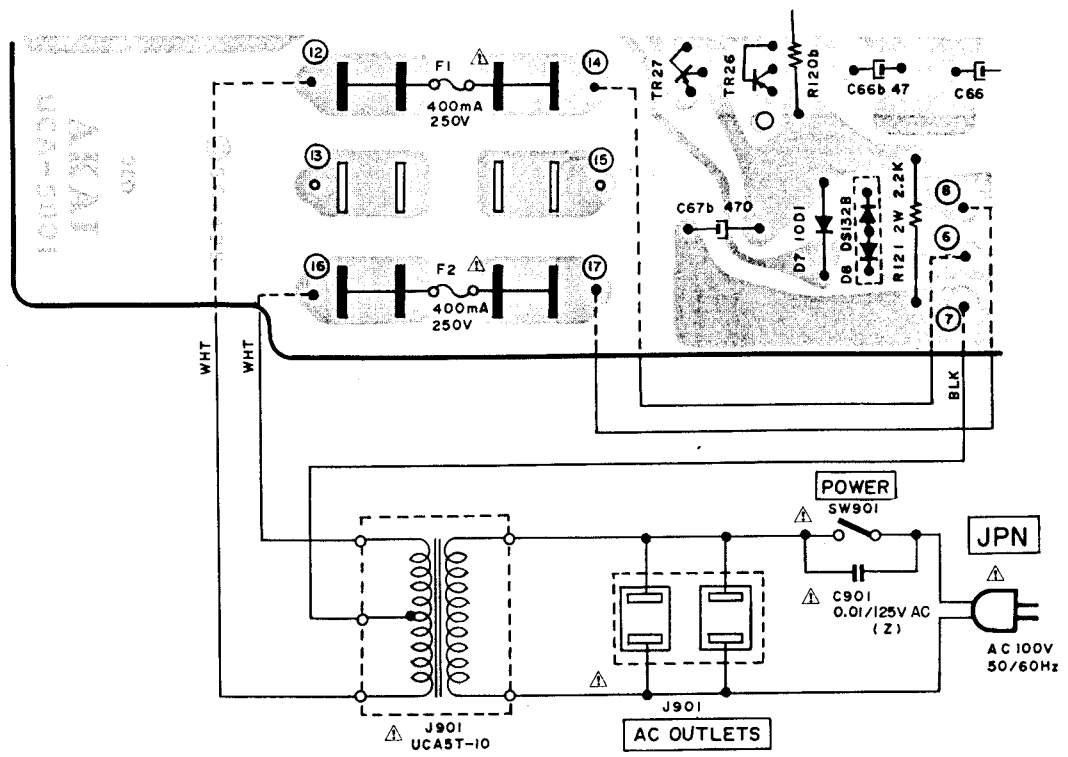

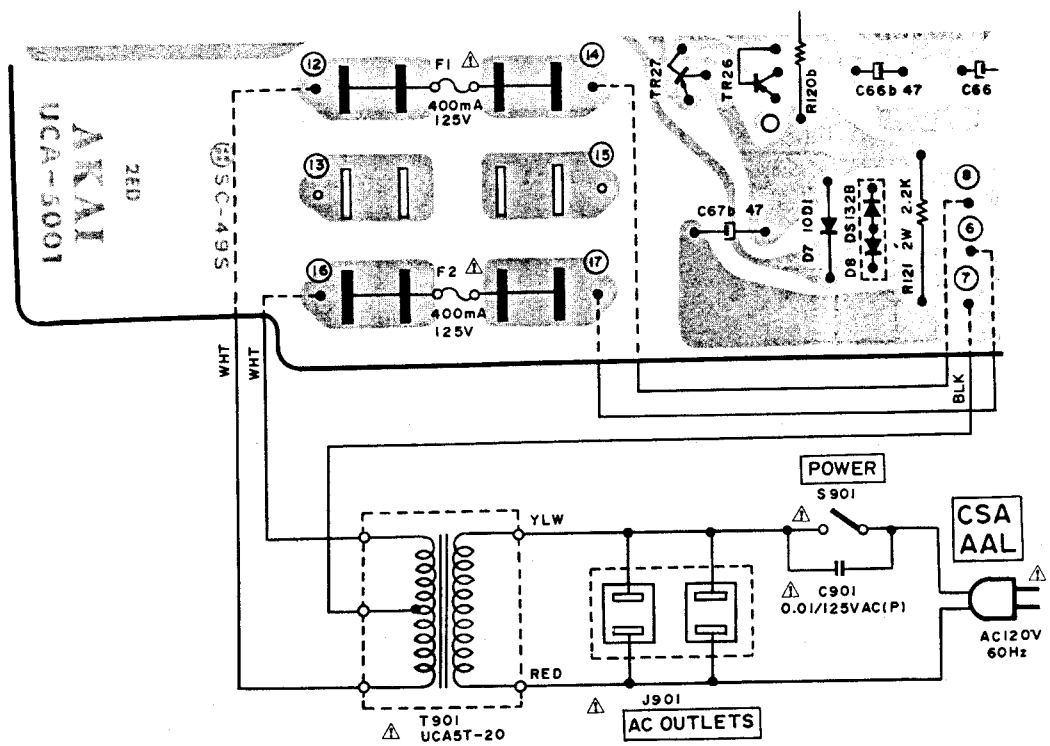

WARNING: ⚠ INDICATES SAFETY CRITICAL COMPONENTS. FOR CONTINUED SAFETY, REPLACE SAFETY CRITICAL COMPONENTS ONLY WITH MANUFACTURER'S RECOMMENDED PARTS

AVERTISSEMENT: ⚠ IL INDIQU LES COMPOSANTS CRITIQUES DE SÛRETÉ. POUR MAINTENIR LE DEGRÉ DE SÛRETÉ DE L'APPAREIL, NE REMPLACER LES COMPOSANTS DONT LE FONCTIONNEMENT EST CRITIQUE POUR LA SÛRETÉ QUE PAR DES PIÈCES RECOMMANDÉES PAR LE FABRICANT

UC-A5

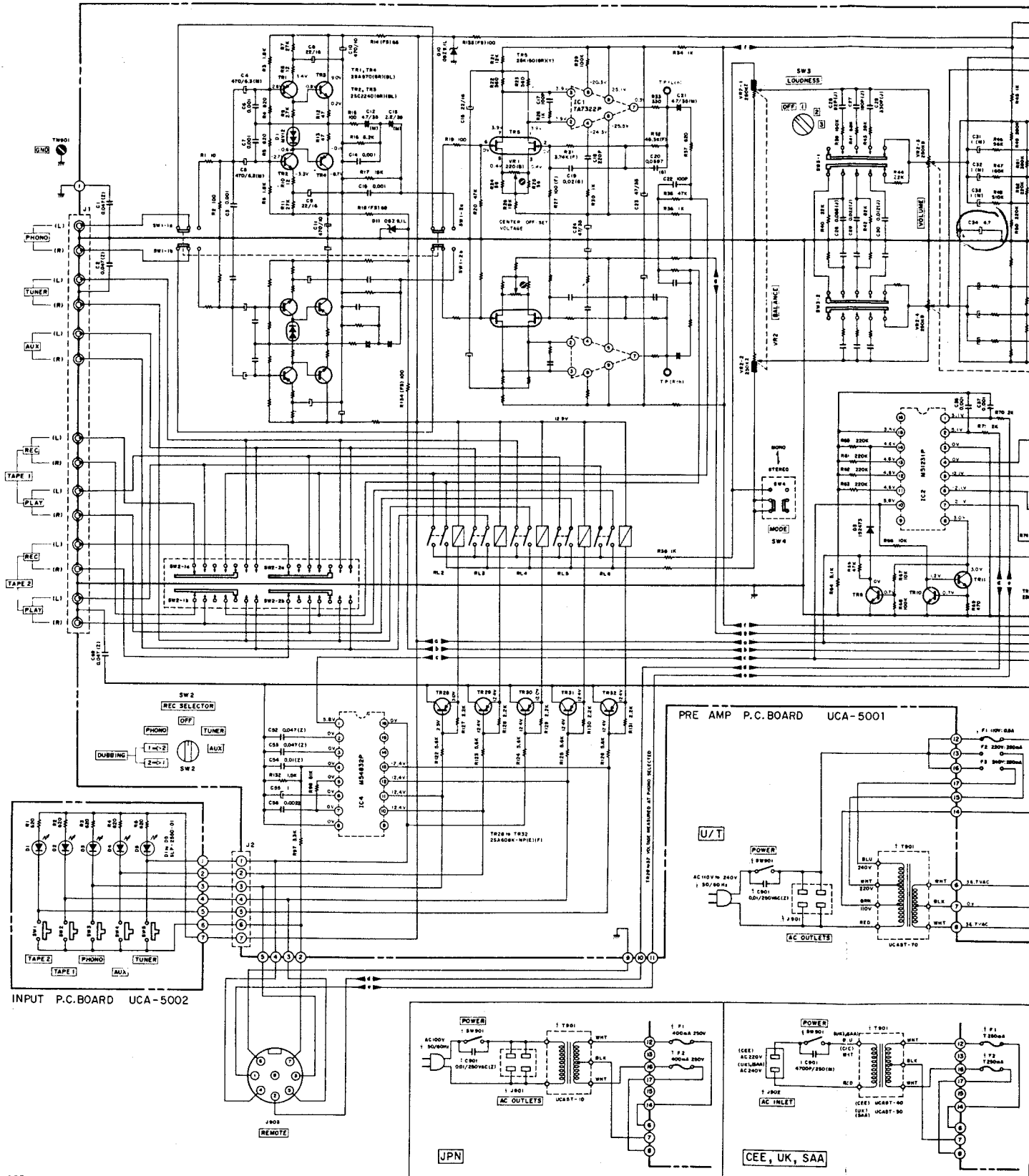

NO 001088B



G

H

I

J

K

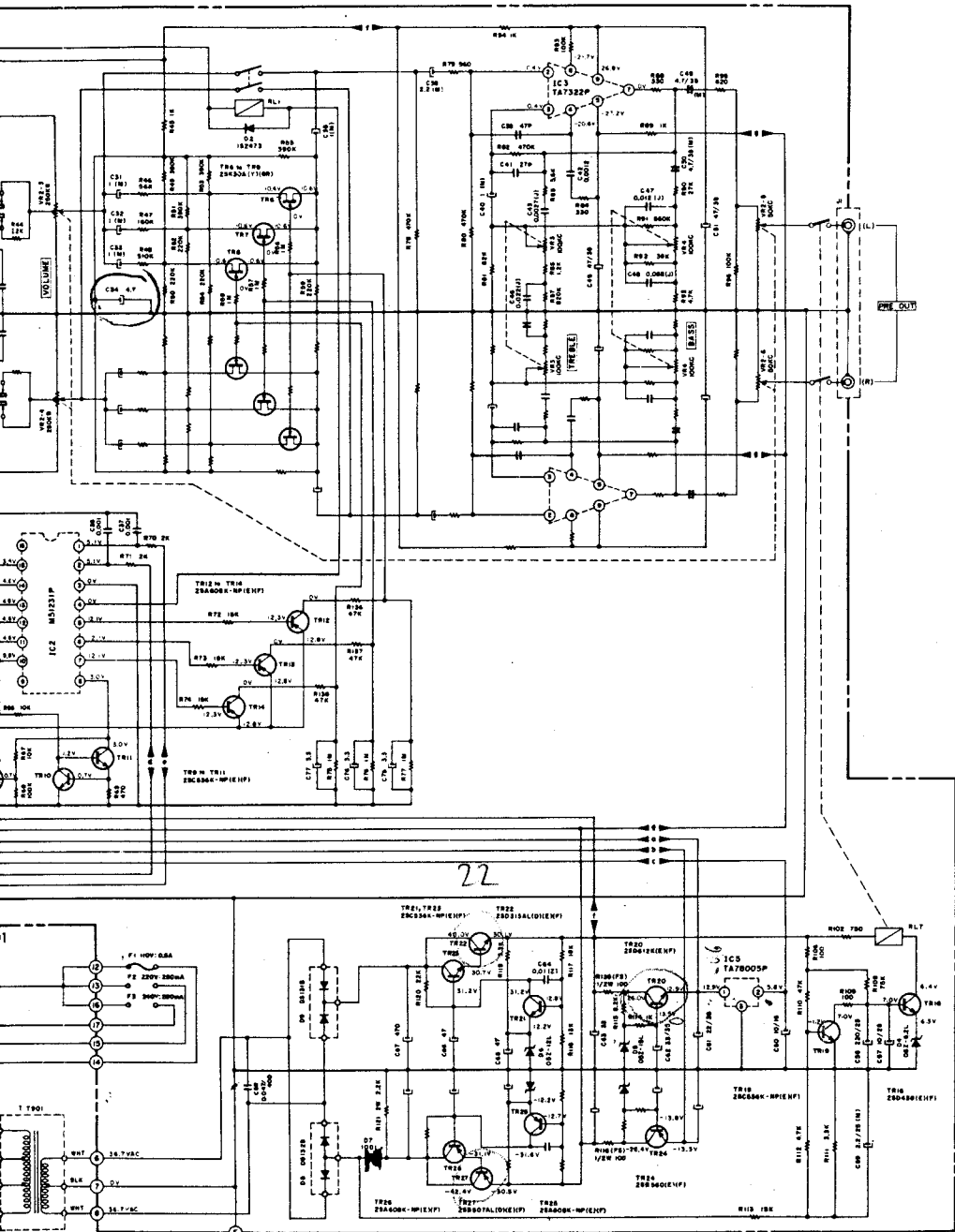

- 25A608-NP  
25A870  
25C338-NP  
25C2240
- D G S  
25K30A
- 25B560  
25B438
- TA78003P
- 25042K
- 25062K

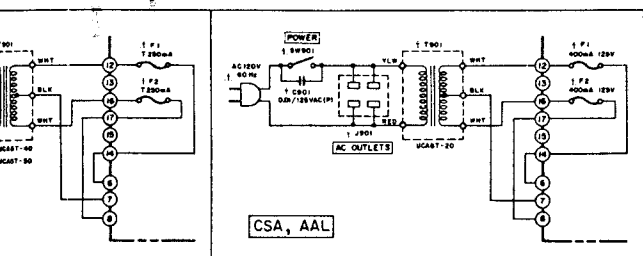

WARNING ⚠ INDICATES SAFETY CRITICAL COMPONENTS FOR CONTINUED SAFETY.  
 REPLACE SAFETY CRITICAL COMPONENTS ONLY WITH MANUFACTURER'S  
 RECOMMENDED PARTS.  
 AVERTISSEMENT ⚠ IL INDIQUE LES COMPOSANTS CRITIQUES DE SÛRETÉ POUR  
 MAINTENIR LE DEGRÉ DE SÛRETÉ DE L'APPAREIL. NE REMPLACEZ LES  
 COMPOSANTS DONT LE FONCTIONNEMENT EST CRITIQUE POUR LA SÛRETÉ  
 QUE PAR DES PIÈCES RECOMMANDÉES PAR LE FABRICANT.

NOTE  
 UNLESS OTHERWISE SPECIFIED  
 ALL RESISTORS IN OHMS (1/4W/1J)  
 ALL CAPACITORS IN  $\mu$ F (50 WV/1J)  
 (FS) = FAIL SAFE RESISTORS  
 (NP) = NON-POLAR CAPACITORS  
 POWER TRANSFORMER IS DIFFERENT  
 ACCORDING TO AREA

UC-A5  
 SCHEMATIC DIAGRAM  
 No. 1600640A