

# **Service** *Manual*

**MODEL: A400.4**

# CONTENT

1. Introduction.....	1
2. Specification.....	2
3. Block Diagram.....	3
4. Schematic Diagram.....	4
5. Wiring Diagram.....	10
6. Printed Circuit Board.....	11
7. Exploded View & Mechanical Parts List.....	13
8. Electrical Parts List.....	15

## 1. Introduction

- 1.5U 1/2 rack, multi-channel high power amplifier.
- Fantastic audio quality even with extremely high volume levels.
- Solid and durable, can be mounted into a cabinet.
- User-controllable clip limiter.
- 4×120Watts on 4 ohms (EIAJ)
- Balanced XLR inputs and 1/4" TRS jack to ensure noiseless long wiring.
- 1/4"TS jack for sp-output.
- Front panel LED indicators for signal, limit and clip.
- Accurate gain control
- Independent thermal overload protection on each channel automatically protects amplifier and speakers.
- Single channel over-heat protection.

## 2. Specification

MODEL	A400.4 DRAGONFLY
20Hz 20KHz@0.1%THD, Stereo Mode	
8 ohms per channel(EIAJ)	65W
4 ohms per channel(EIAJ)	120W
4 ohms per channel(RMS)	62W±3W (at THD:1%)
Input Sensitivity @4 ohms	+3dBu
Controls	FRONT: Power switch, LEVEL knobs
	REAR: Four LIMITER Switches for channel 1- channel 4
Indicators (per channel)	Power-On: Green LED
	Clip: Red LED
	Limit: Yellow LED
	Signal: Green LED
Connectors of each channel	Input: COMBO connector
	Output: 1/4" TS jack connector
Power Supply	190-240 Vac~50Hz / 95-120Vac~60Hz
Dimension	314mm x 208.5mm x 66.6mm
Net Weight	3.8Kg

3. Block Diagram

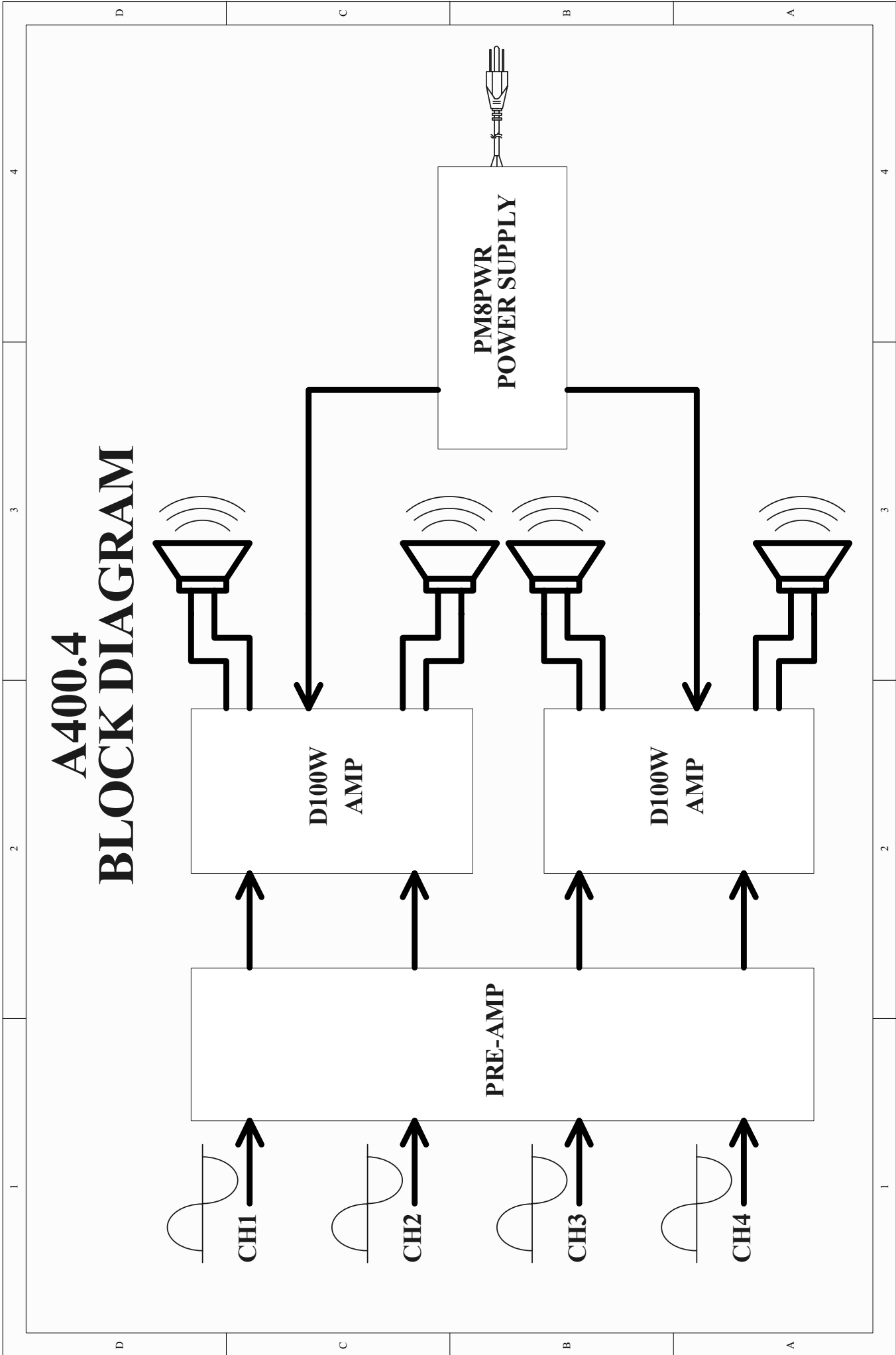

# 4. Schematic Diagram

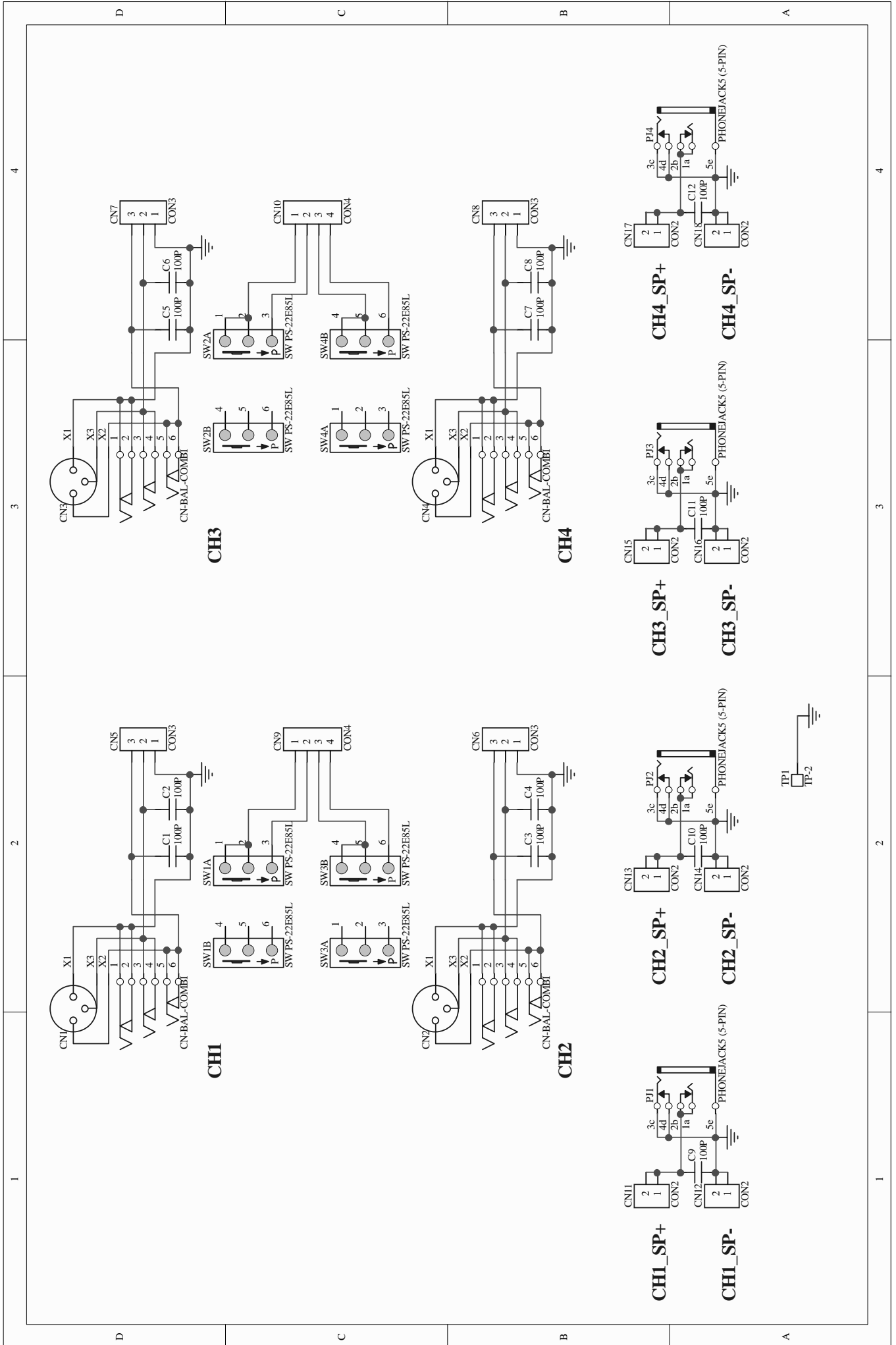

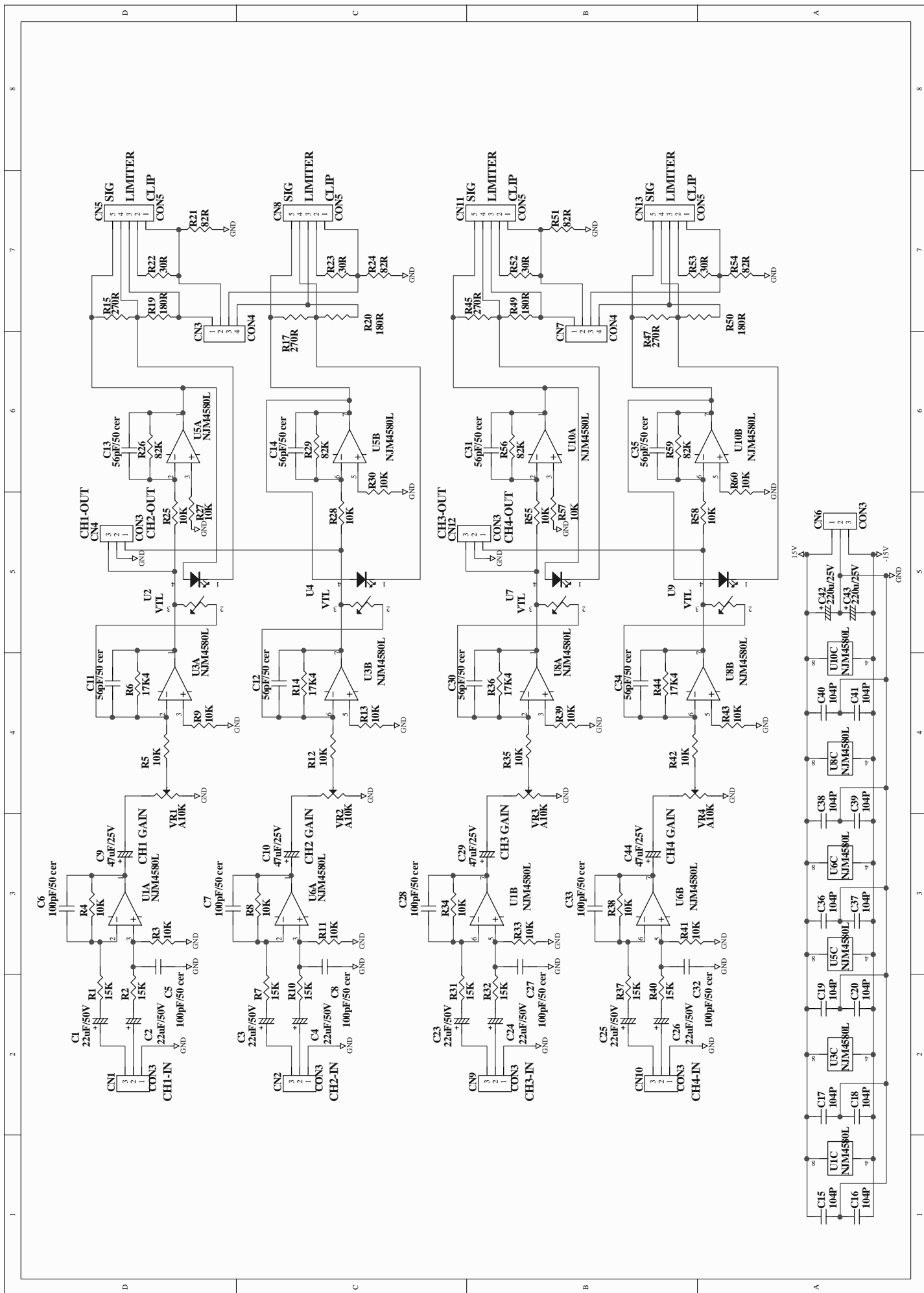

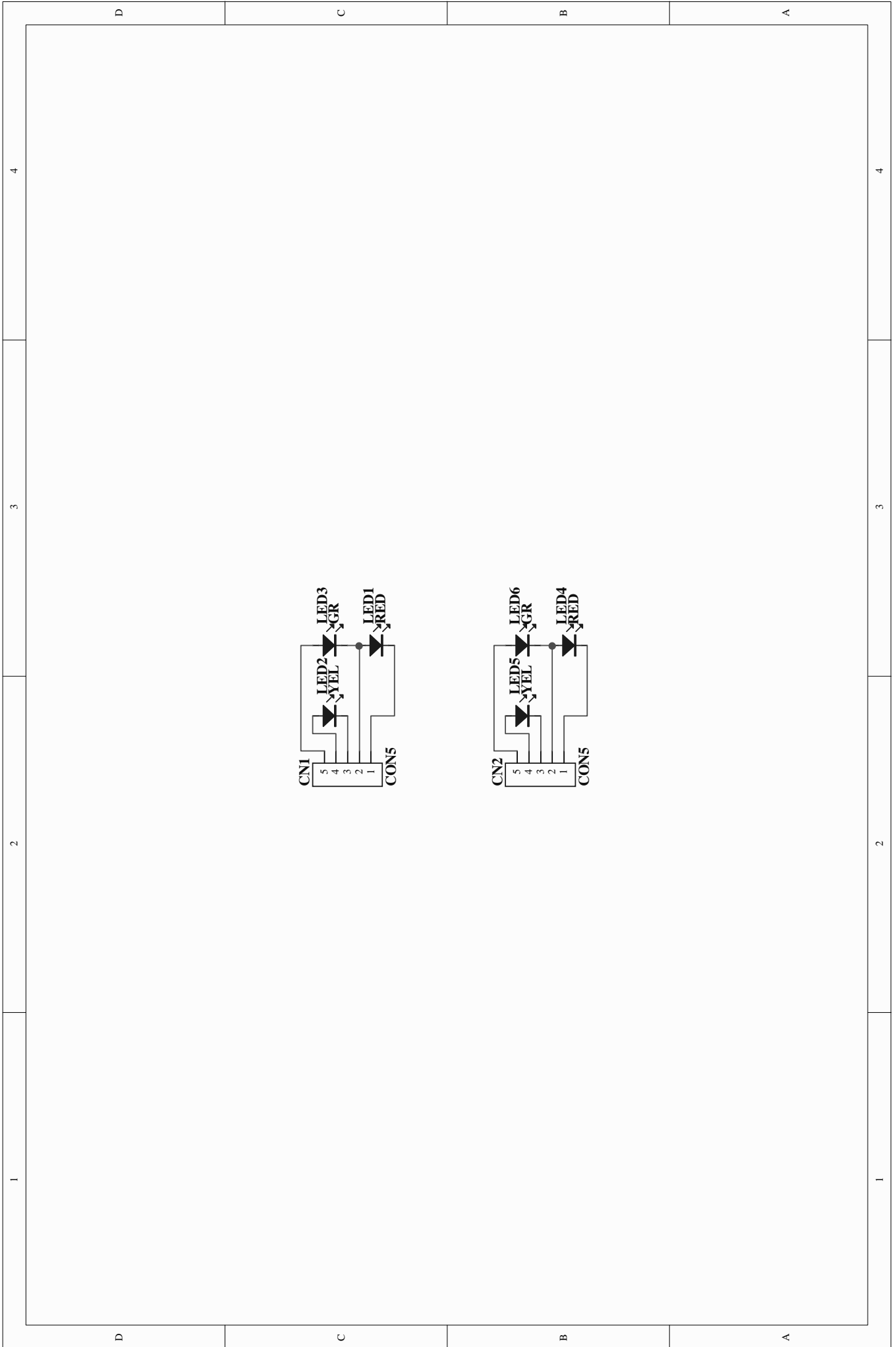



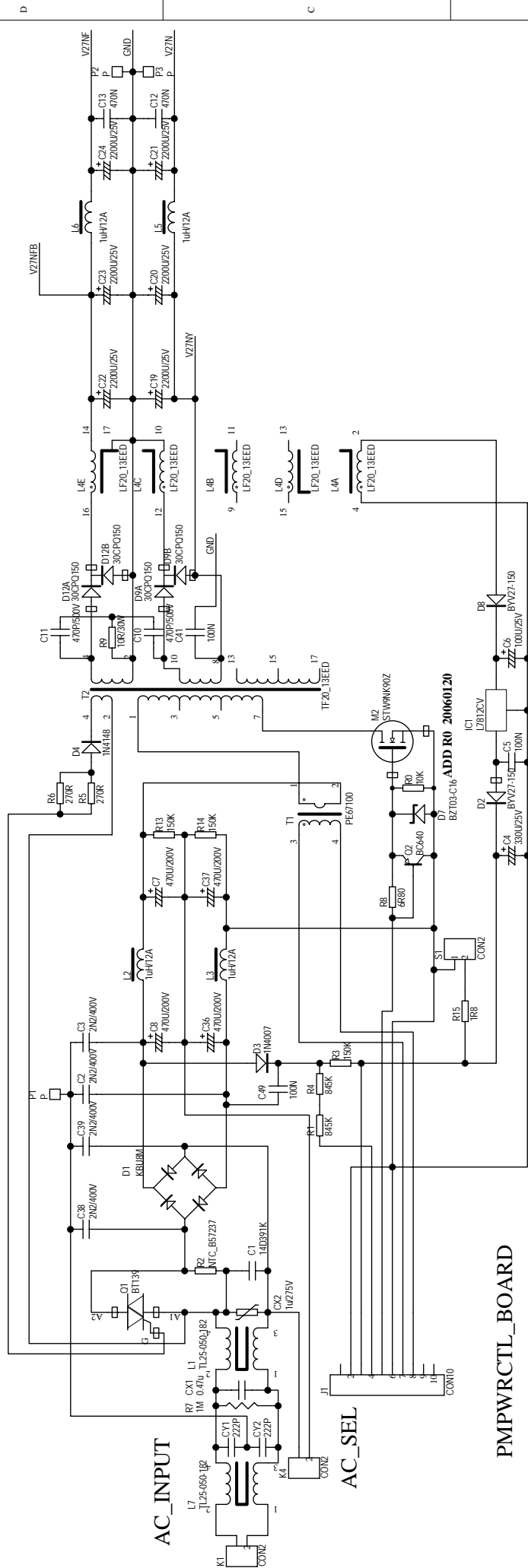

**PMPWRCTL\_BOARD**

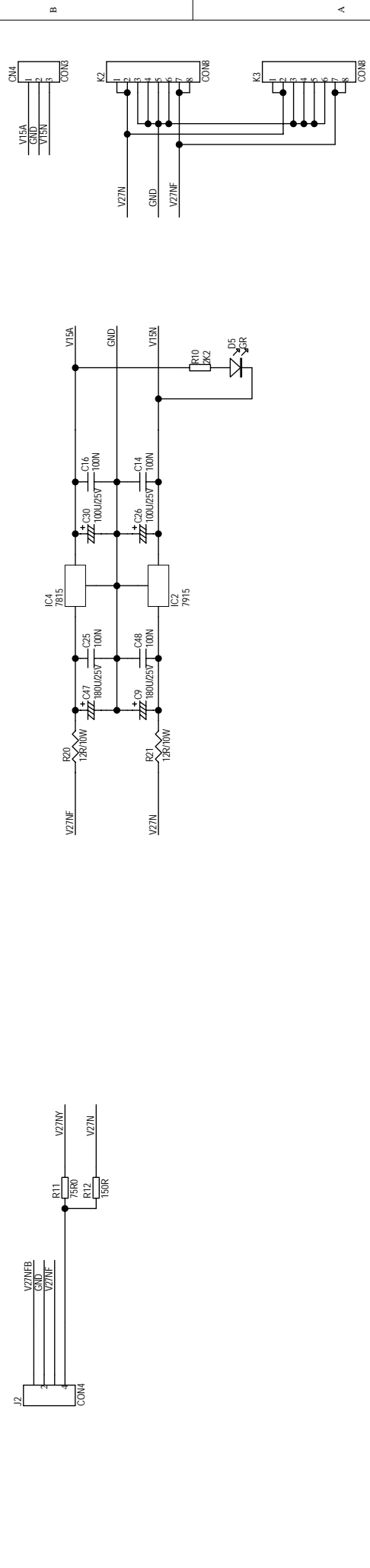

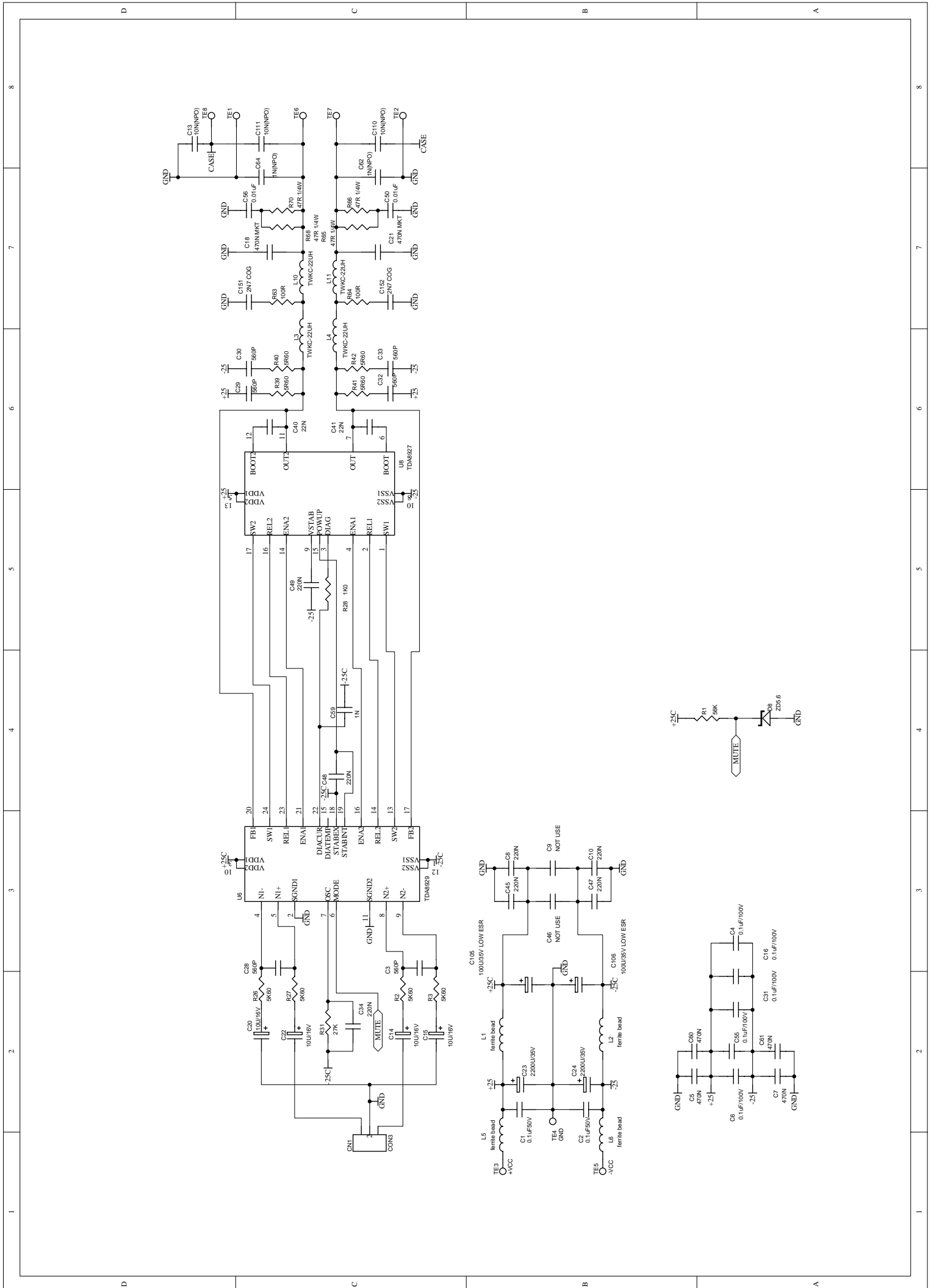

4

3

2

1

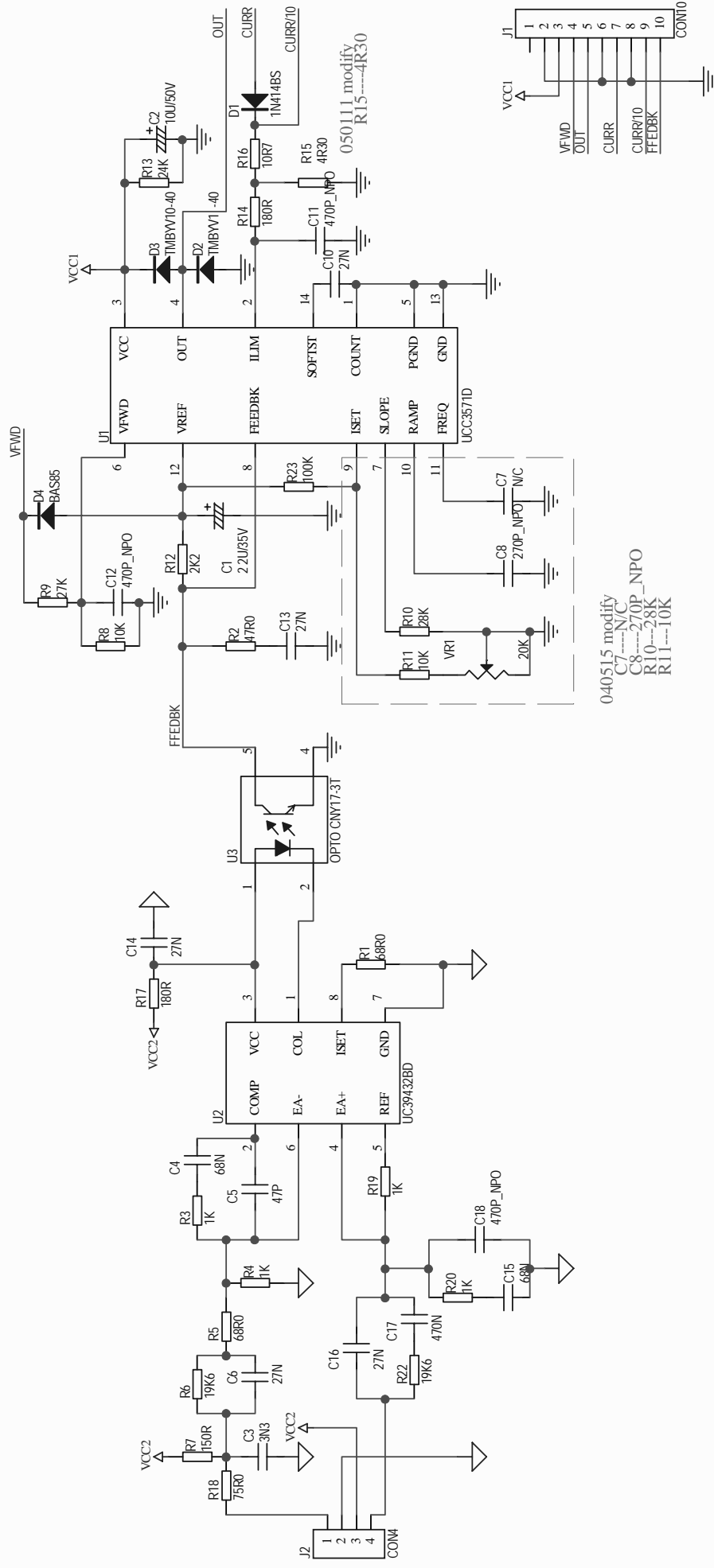

040515 modify  
 C7----N/C  
 C8----270P\_NPO  
 R10----28K  
 R11----10K

## 5. Wiring Diagram

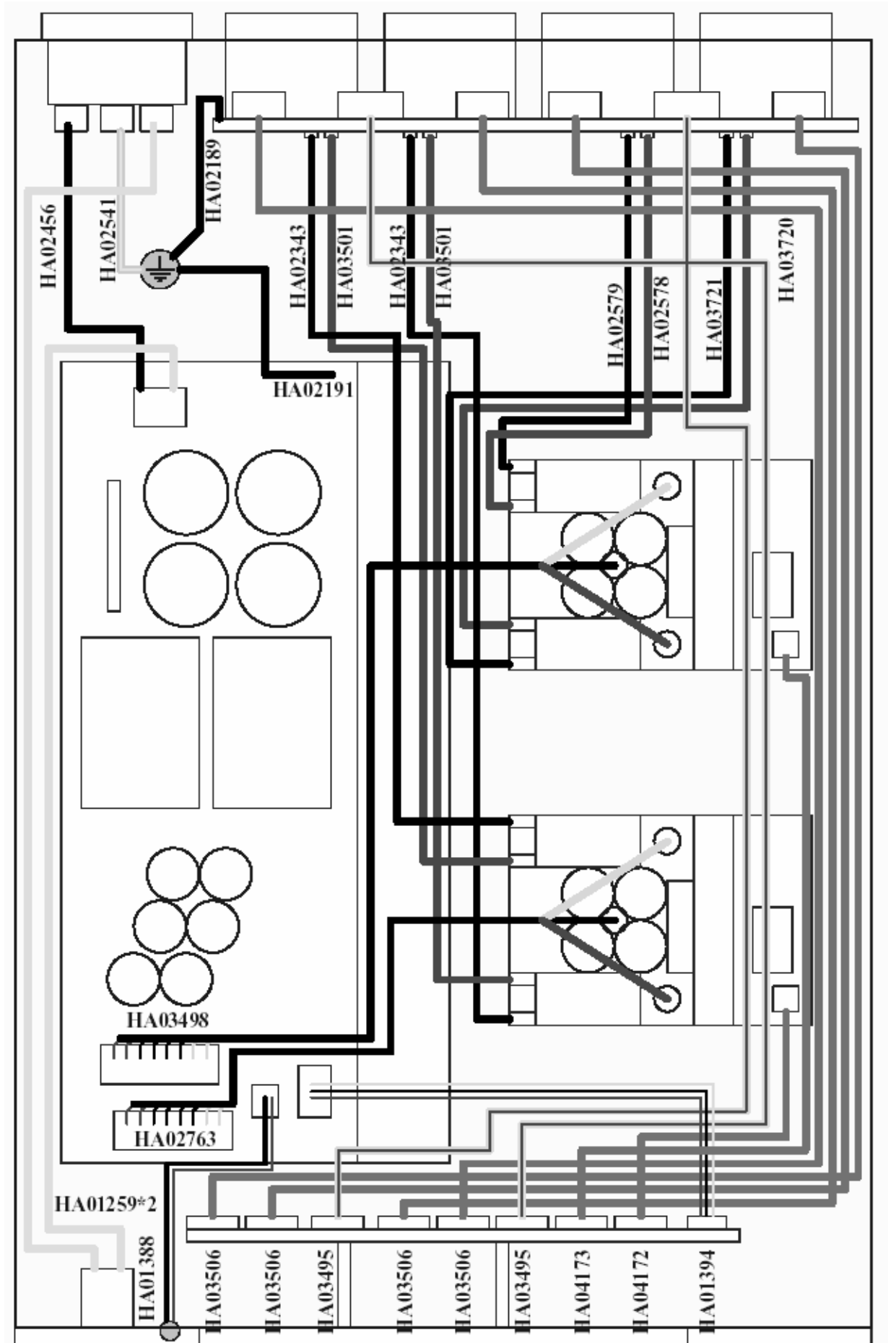

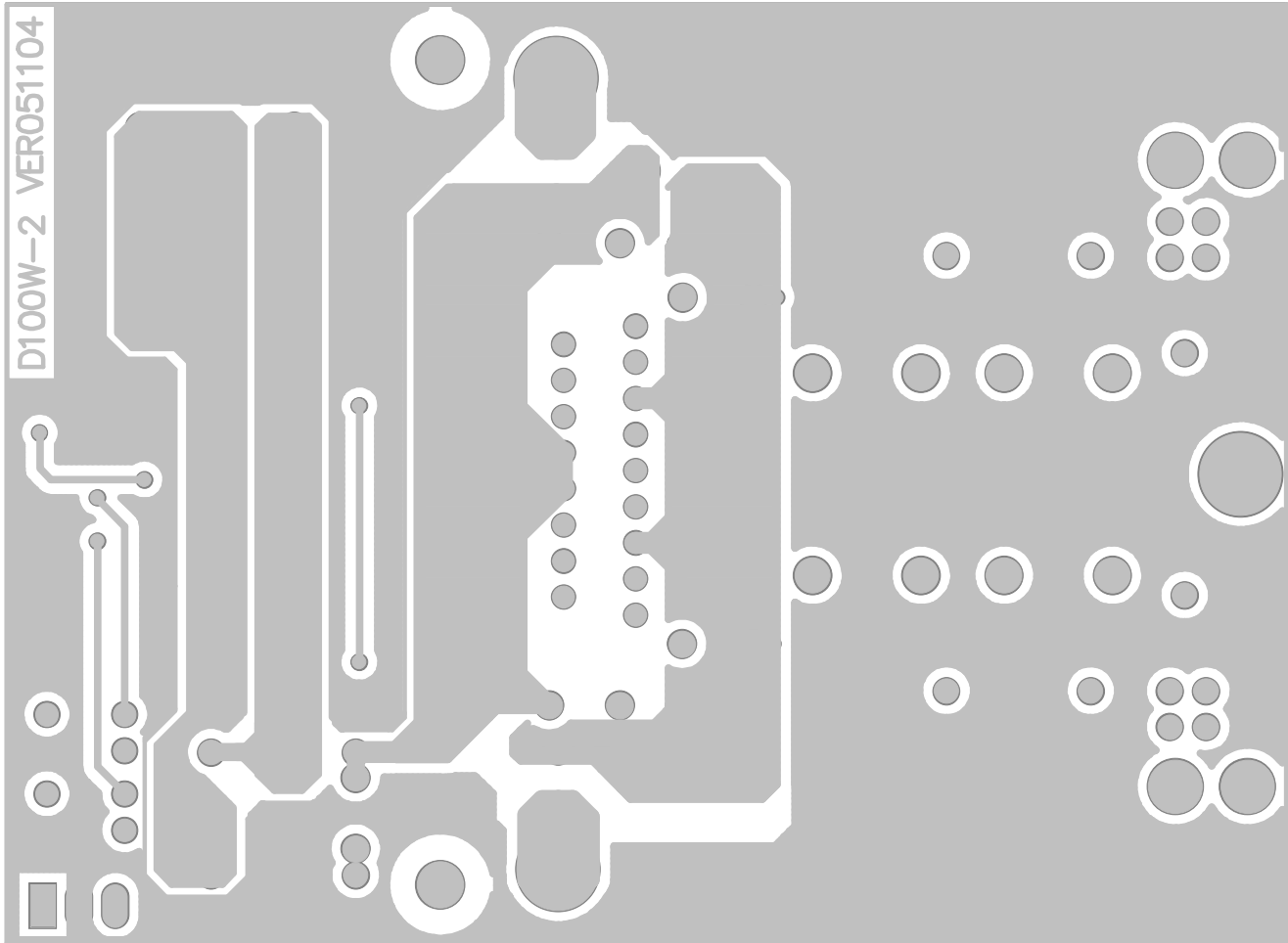
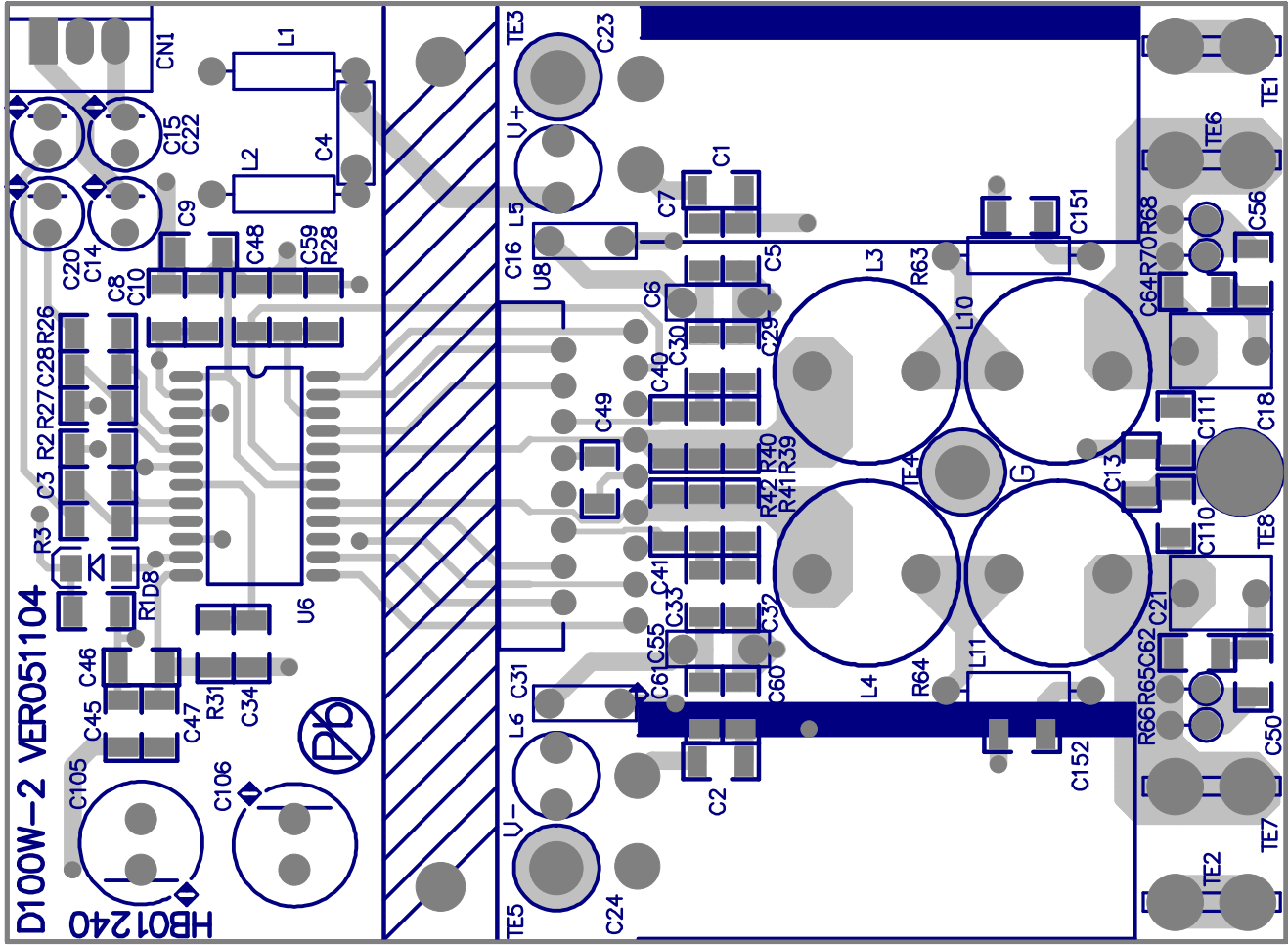

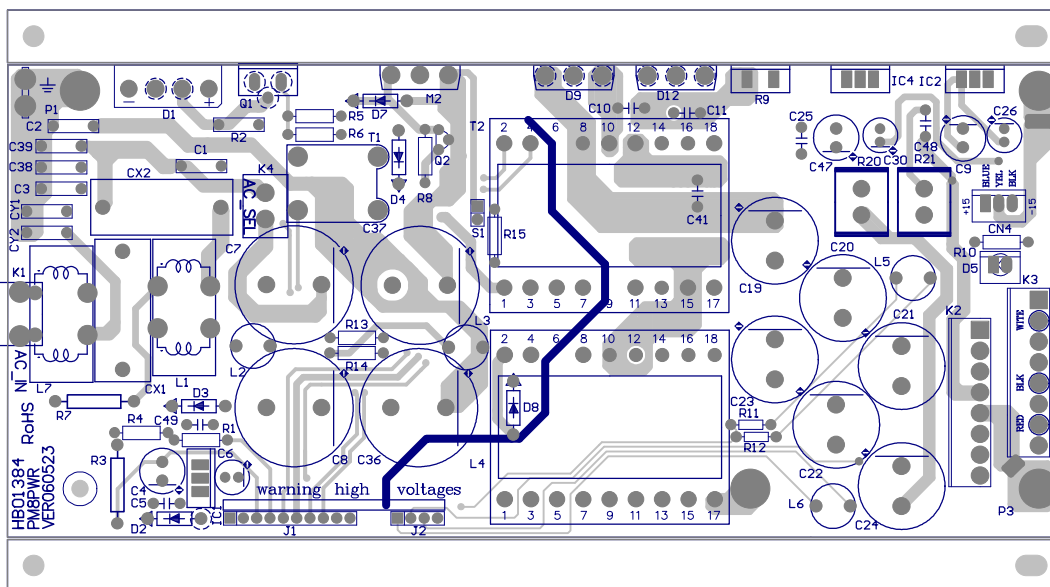
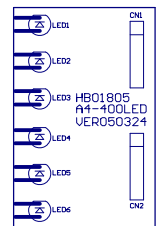
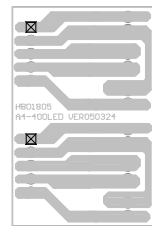
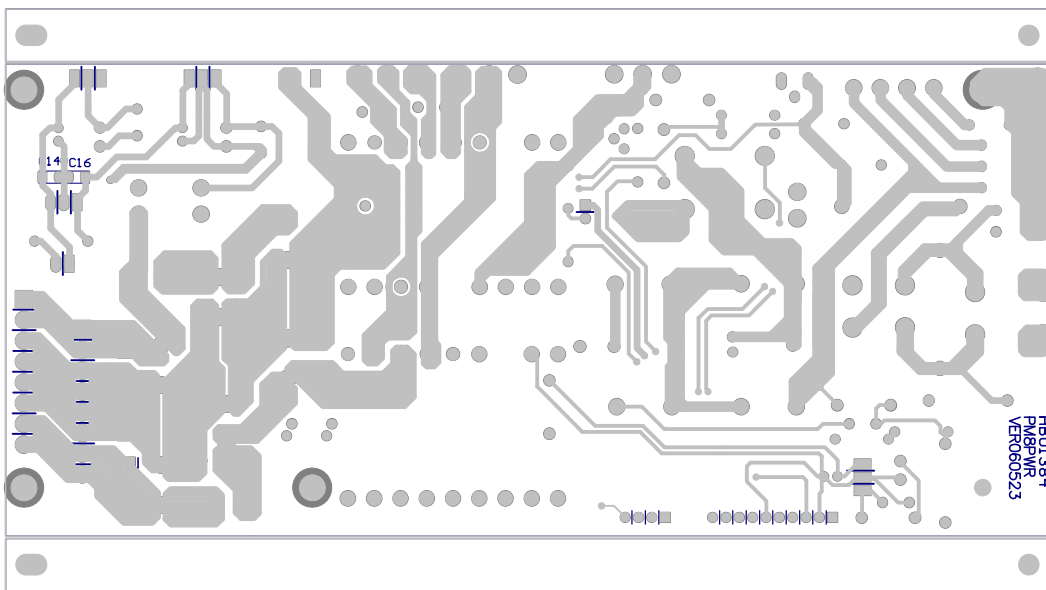
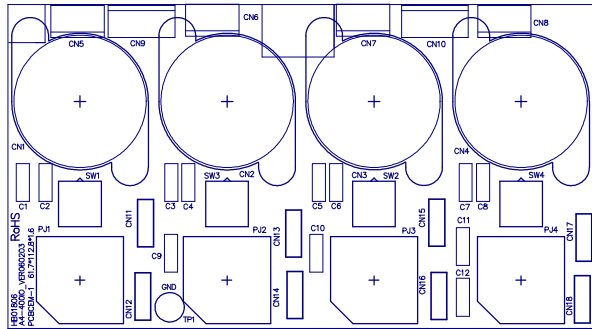
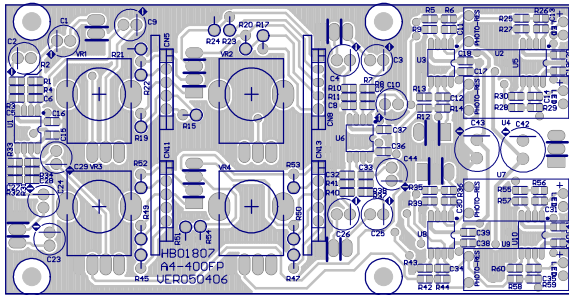
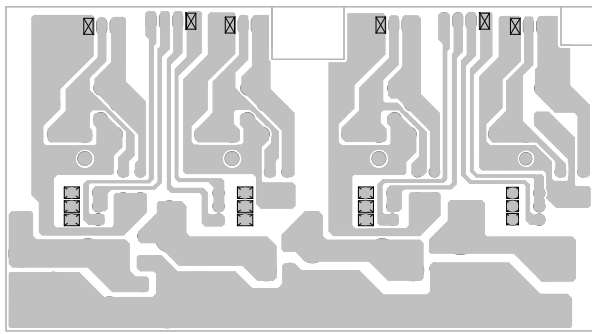
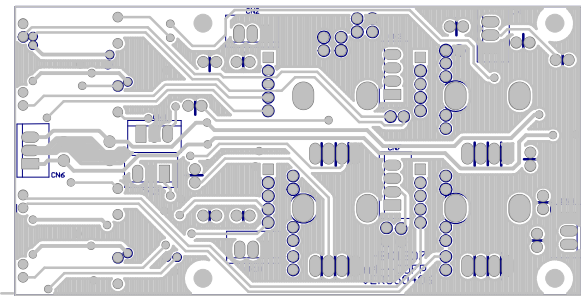

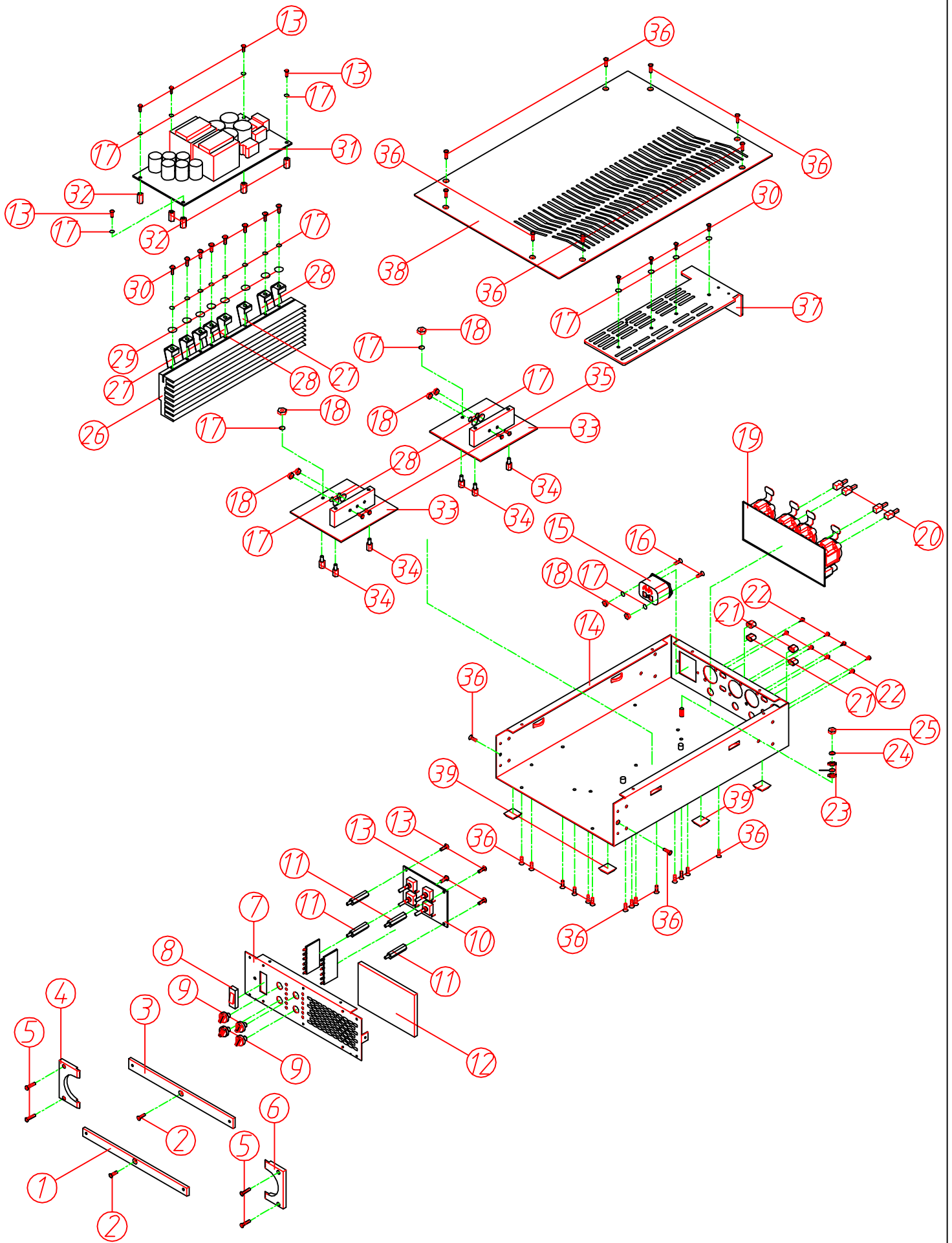

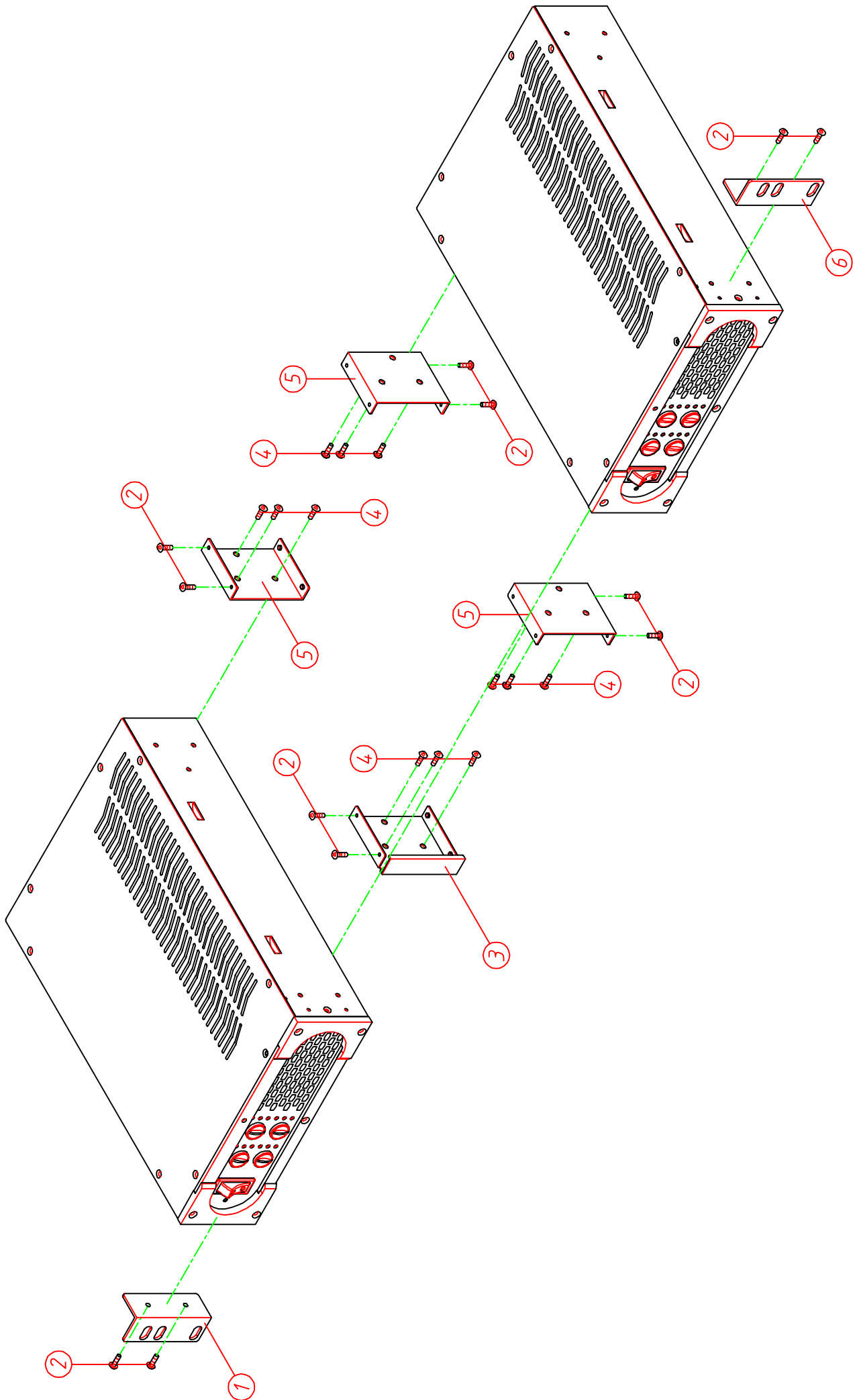



## 8. Electrical Parts List

No.	Part No.	Description	Specification	Remark
1	MA05618	panel	A400.4 DRAGONFLY ALTO_V1.0	1
2	MA05584	panel	A400.4	
3	MA05583	panel	1.0t*12*63.6*205.5 A400.2_V1.5	
4	ME00184	iron pillar	A200.2 M3*11.2*0.5PH*φ5.8_V1.0	
5	MJ00058	single light board	1*2135*1220 20.45kg	
6	MI03126	front board	A400.4 DRAGONFLY ALTO left_V1.0	
7	MI02595	front board	A1000.4 left	
8	MI02596	front board	A1000.4 left_V1.0	
9	MI02959	front board	6*40*1M(1M/0.59kg) A500.2_V1.0	
10	MB04429	chassis	A400.4 DRAGONFLY ALTO_V1.2	
11	MB04401	chassis	A400.4	
12	MB04400	chassis	A400.4 64.8*208.5*308_V1.7	
13	ME00001	screw pillar	M4*10*0.7PH	
14	ME00038	iron pillar	6.35*M3*8.4_V1.3	
15	MJ00059	single light board	1.2*2135*1220 24.54kg	
16	AE00055	solvent	solvent	
17	AE00060	paint	4534	
18	MJ00476	cushion	A500.2 up_V1.1	
19	MJ00477	cushion	A500.2 up_V1.2	
20	MJ00057	AL plate-RS	3.0t*2000*1000mm 16.32kg	
21	MJ00478	cushion	A500.2 down_V1.1	
22	MJ00479	cushion	A500.2 down_V1.2	
23	MJ00057	AL plate-RS	3.0t*2000*1000mm 16.32kg	
24	MI02593	front board	A1000.4 right_V1.0	
25	MI02594	front board	A1000.4 right_V1.0	
26	MI02959	front board	6*40*1M(1M/0.59kg) A500.2_V1.0	
27	MI03073	heat-sink	A400.4 31.8*90*210_V1.3	
28	MJ00057	AL plate-RS	3.0t*2000*1000mm 16.32kg	
29	MC00675	top cover	A500.2 DRAGONFLY_V1.3	
30	MC00671	top cover	A500.2	
31	MC00670	top cover	1.2t*208.5*308*1.2 A500.2_V1.5	
32	MJ00059	single light board	1.2*2135*1220 24.54kg	
33	AE00055	solvent	solvent	
34	AE00060	paint	4534	
35	NI03389	net	A500.2 96*61.6*5t_V1.0	
36	HI00031	power switch-RS	R415KKETOF	
37	HC00423	FUSE holder	4A (EMI-power filter)	
38	HD00018	glass tube fuse	6.3A 250V φ5.2*20mm CCEE/CSA/S/UL/VDE	
39	NI00262	sleeve	φ5*25mm	
40	NI00258	sleeve	φ5*1000mm	
41	NI01862	key	5.5*5.5*14.5_V1.1	
42	NI01863	key-RS	φ5.5*W10*7.5	

No.	Part No.	Description	Specification	Remark
43	NI00360	knob	φ15*15mm	
44	SA00052	L.E.D	φ3 round(green)long foot 26	
45	NI00222	sleeve	φ1.5*30mm	
46	NI00221	sleeve	1.5φ*1000mm	
47	HA01388	row-wire connector wiring	2P 100	
48	MG00281	screw	M3*6	
49	MG00578	screw	M3*10*0.5PH_V1.0	
50	MG00041	screw	M3*6	
51	MG00561	copper pillar	M3*20*0.5PH 26	
52	MG00025	screw	M3*6	
53	MG00042	screw	M3*10	
54	MG00061	screw	M3*10	
55	MG00162	screw	M3*8	
56	MF00037	washer	φ3.2*φ5.5*1t	
57	MF00014	washer	φ3*φ6.5*0.5t	
58	ME00016	color nut	4m/m	
59	MF00038	washer	φ4*φ7*1t	
60	MF00048	washer	φ4*φ8*0.5t	
61	MF00061	MIC jack	φ9.6*φ13*0.5t	
62	ME00060	MIC jack	JY-6351G-02-250	
63	HA03495	wire	4P-4P 500mm UL1007 28AWG	
64	HA01394	row-wire connector wiring	3P-3P 120	
65	HA03506	wire	3P-3P 500mm UL2547 28AWG	
66	HA04172	wire	3P-3P 150mm UL2547 28AWG	
67	HA04173	wire	3P-3P 250mm UL2547 28AWG blue	
68	HA03498	wire	8P 280mm UL1007 18AWG	
69	HA02763	wire	8P 200mm UL1007 18AWG	
70	ND00150	silicone sleeve	φ12*150mm	
71	ND00026	silicone sleeve	100*20	
72	NI00218	cable tie	ALT-102SB	
73	HA00861	power cord Europe 3P	LT-312+LT-501	
74	NA00137	clip-chain bag	5*7	
75	NI00498	self-adhere foot cushion	12.7*7*6mm(SF-005)	
76	HJ00006	dessicant	30g	
77	NA00123	PE bag	0.04t*580*300mm	
78	NE11347	label	ALTO PI	
79	NH00334	cone paper	0.040*1m	
80	NF00061	assurance card	ALTO	
81	NA00279	clip-chain bag	0.04t*100*150mm_V1.0	
82	AD00012	twin adhesive	90*120mm_V1.0	
83	HK05925	PC board	P-A4-400IO	
84	HB01806	PCB	A4-400IO_VER060203	

No.	Part No.	Description	Specification	Remark
85	HC00077	connector(male)	3P 2.5mm 180°	CN5,CN6,CN7,CN8
86	HC00078	connector(male)	4P 2.5mm 180°	CN9,CN10
87	HC00391	balance MIC jack	CXLF-07L(PUSH)/(BELTON)	CN1,CN2,CN3,CN4
88	HI00162	push-button switch	2 paragraphs 6p PS-22E8552L	SW1,SW2,SW3,SW4
89	CA00024	ceramic capacitor	100PF SL	C2,C3,C4,C5,C6,C7,C8,C9,C10,C11,C12
90	HC00371	MIC jack	SCJ-0658-1-Y	PJ1,PJ2,PJ3,PJ4
91	HA03720	single terminal wiring	240mm UL1015 18AWG red	CN11
92	HA03721	single terminal wiring	240mm UL1015 18AWG black	CN12
93	HA02578	single terminal wiring	220mm UL1007 18AWG red	CN13
94	HA02579	single terminal wiring	220mm UL1007 18AWG black	CN14
95	HA02343	single terminal wiring	300mm UL1015 18AWG	CN16,CN18
96	HA02189	single terminal wiring	100mm	TP1
97	ND00206	silicone sleeve	φ6*140mm	
98	ND00202	silicone sleeve	φ6*1000mm	
99	AC00179	tin without lead	M705E Sn 3Ag-0.5Cu	
100	HK05945	PC board	P-A4-400FP-DIP	
101	RA00169	fixed resistor 1/4W	33Ω F type	R22,R23,R52,R53
102	RA00180	fixed resistor 1/4W	82Ω F type	R21,R24,R51,R54
103	RA00190	fixed resistor 1/4W	180Ω F type	R19,R20,R49,R50
104	RA00195	fixed resistor 1/4W	270Ω F type	R15,R17,R45,R47
105	CB00029	electrolytic capacitor	22uF/35V φ5*11mm	C1,C2,C3,C4,C23,C24,C25,C26
106	CB00039	electrolytic capacitor	47uF/25V φ5*11mm	C9,C10,C29,C44
107	HC00077	connector(male)	3P 2.5mm 180°	CN1,CN2,CN4,CN6,CN9,CN10,CN12
108	HC00078	connector(male)	4P 2.5mm 180°	CN3,CN7
109	RC00209	potentiometer	A10KΩ RV110-40E1-225A-A14	VR1,VR2,VR3,VR4
110	AC00179	tin without lead	M705E Sn 3Ag-0.5Cu	
111	HK02231	Photodiode	P-photosensitive resistance+φ5LLED	U2,U4,U7,U9
112	RH00020	photosensitive resistance	VT90N1	
113	SA00201	L.E.D	φ5 red(LI3330/A)	
114	NI02779	sleeve	φ9*30mm	
115	NI00274	sleeve	φ9*1000mm	
116	HK05926	PC board	P-A4-400LED	CN5-CN11,CN8-CN13
117	HB01805	PCB	A4-400LED_VER050324	
118	SA00052	L.E.D	φ3 round(green)long foot 26	LED3,LED6
119	SA00053	L.E.D	φ3 round(red)long foot 26mm	LED1,LED4
120	SA00054	L.E.D	3m/m round(yellow)long foot 26	LED2,LED5
121	HC00655	connector	2.54 90° 5P 6/14mm 1.2mm	CN1,CN2
122	AC00179	tin without lead	M705E Sn 3Ag-0.5Cu	
123	HK05927	PC board	P-A4-400FP-SMD	
124	RD00101	SMD fixed resistor 1/10W	10KΩ ±5% 0603	R3,R4,R5,R8,R9,R11,R12,R13,R25,R27,R28,R30,R33,R34,R35,R38,R39,R41,R42,R43,R55,R57,R58,R60
125	RD00103	SMD fixed resistor 1/10W	15KΩ ±5% 0603	R1,R2,R7,R10,R31,R32,R37,R40

No.	Part No.	Description	Specification	Remark
126	RD00293	SMD precise resistor 1/10W	17.4K $\Omega$ $\pm$ 1% 0603	R6,R14,R36,R44
127	RD00115	SMD fixed resistor 1/10W	82K $\Omega$ $\pm$ 5% 0603	R26,R29,R56,R59
128	CI00056	SMD ceramic capacitor 0603	56PF/50V NPO $\pm$ 5%	C11,C12,C13,C14,C30,C31,C34,C35
129	CI00059	SMD ceramic capacitor 0603	100PF/50V NPO $\pm$ 5%	C5,C6,C7,C8,C27,C28,C32,C33
130	CI00075	SMD ceramic capacitor 0603	0.1uF/50V Y5V +80,-20%	C15,C16,C17,C18,C19,C20,C36,C37,C38,C39,C40,C41
131	SG00122	SMD integrated circuit	NJM4580M-TE3	U1,U3,U5,U6,U8,U10
132	AE00449	solder material without lead	9308/Sn Ag Cu	
133	HB01807	PCB	A4-400FP_VER050406	
134	CB00056	electrolytic capacitor	220uF/25V $\phi$ 8*11mm	C42,C43
135	HK05802	PC board	P-PM8PWR-DIP(A400.4)	
136	CB00130	electrolytic capacitor	100uF/25V 105 SH $\phi$ 6*11mm	C26,C30,C6
137	CB00131	electrolytic capacitor	180uF/25V 105 WL $\phi$ 8*11mm	C9,C47
138	CB00132	electrolytic capacitor	330uF/25V 105 LZ $\phi$ 8*15mm	C4
139	CB00133	electrolytic capacitor	470uF/200V 85 LP $\phi$ 22*40mm	C36,C37,C7,C8
140	CB00164	electrolytic capacitor	2200uF/35V 105 $^{\circ}$ C TL $\phi$ 16*32mm	C19,C20,C21,C22,C23,C24
141	CG00056	X2 capacitor	0.47uF/275VAC	CX1
142	CG00065	X2-capacitor MPX	1.0uF/275V VDE/UL/CSA	CX2
143	CG00028	metal oxide varistors	CNR-14D391K	C1
144	CG00030	X1/Y2 capacitor	2200PF/400V Y5V $\pm$ 20% Y2CAP	C2,C3,C38,C39,CY1,CY2
145	CG00033	metal oxide varistors	B57237-S100-M	R2
146	CN00150	common inductance	TC2208-15mH/V644	L1
147	CN00151	common inductance	TC2208-20mH/V645	L7
148	CH00027	laminated capacitor	0.1uF/100V X7R PH5mm	C25,C41,C5,C48,C49
149	CH00028	laminated capacitor	470PF/100V X7R PH5mm	C10,C11
150	CN00058	inductance	1UH/12A(CR4F-302817)	L2,L3,L5,L6
151	RA00573	precise resistor 1/4W	150K $\Omega$ M type	R13,R14
152	RA00727	precise resistor 1/8W	75.0 $\Omega$ M type	R11
153	RA00728	precise resistor 1/8W	150 $\Omega$ M type	R12
154	RA00729	precise resistor 1/4W	1.80 $\Omega$ M type	R15
155	RA00730	precise resistor 1/4W	6.80 $\Omega$ M type	R8
156	RA00731	precise resistor 1/4W	270 $\Omega$ M type	R5,R6
157	RA00733	precise resistor 1/4W	845K $\Omega$ M type	R4,R1
158	RA01009	fixed resistor 1W	130K P type	R3
159	RA01440	precise resistor 1/2W	1M $\Omega$	R7
160	RA00735	precise resistor 30W	10.0 $\Omega$ TO-126 MP930-10.0-1%	R9
161	SA00004	high speed diode	2A/100V BYV27-200,113	D2,D8
162	SA00007	bridge rectifier	8A KBU-806 comb type	D1
163	SA00093	rectifier diode	1N4148 0.5A	D4
164	SA00159	rectifier diode	1A/1000V IN4007	D3
165	SA00146	zener diode	3W 16V BZT03-C16	D7
166	SA00147	diode	30A/150V IR30CPQ150	D12,D9
167	SB00056	Bidirectional S.C.R	double direct s.c.r	Q1

No.	Part No.	Description	Specification	Remark
168	SB00109	transistor	BC640	Q2
169	SD00066	integrated circuit	L7812CV(TO-220)(ST)	IC1
170	TC00118	transformer	PE-67100	T1
171	TC00203	transformer	4022-369-7449.2	L4
172	TC00202	transformer	27-12-648	T2
173	TC00168	transformer	27-12-648	
174	HI00176	thermal switch	OP62/100 /145mm	
175	RA00701	fixed resistor 1/4W	2.2KΩ M type	R10
176	RA00870	chassis bracket 5W	12Ω SQM type	R20,R21
177	HC00076	connector(male)	2P 2.5mm 180°	D5
178	HC00175	connector(male)	4P 3.96mm 180°	K2-1,K2-2,K3-1,K3-2
179	HC00077	connector(male)	3P 2.5mm 180°	CN4
180	HC00324	connect terminal	6.5m/m (PC250)	P1
181	MF00014	washer	φ3*φ6.5*0.5t	
182	SD00077	integrated circuit-RS	L7815CV(TO-220)(ST)(MOROCCO)	IC4
183	SD00079	integrated circuit	L7915CV(TO-220)(ST)	IC2
184	MI02598	heat-sink	A1000.4 21*50*190 0.3kg_V1.3	
185	MI03119	heat-sink	21*50*1M+5(1M/1.6KG)_V1.0	
186	MK00080	battery cover	0.4*10*12*35mm PM8-PWR_V1.1	Q1,D9,D12,R9,IC4,IC2
187	NI01877	silicone sleeve	φ10*28mm T0.45mm	
188	NI03044	silicone sleeve	φ14*35 T0.45mm	
189	MG00041	screw	M3*6	
190	MF00037	washer	φ3.2*φ5.5*1t	
191	MF00132	MIC jack	φ3*φ8*0.8t_v1.0	
192	MF00030	washer	φ3.5*φ8*0.8t_V1.0	
193	MJ00067	single light board	0.8t*2135*1220mm 18.69kg	
194	MG00244	copper pillar	M3*10*0.5PH	
195	MG00162	screw	M3*8	
196	CN00036	bead coil	T-3.5*1.2*5.2(22-06)	
197	NI03545	sleeve	φ8*35mm	
198	NI00272	sleeve	φ8*1000mm	
199	AC00179	tin without lead	M705E Sn 3Ag-0.5Cu	
200	HK04217	PC board	P-PM8PWR-SMD	
201	HB01384	PCB-RS	PM8PWR_VER060523	
202	CI00095	SMD ceramic capacitor 1206	0.1uF/50V X7R	C14,C16
203	CI00118	SMD ceramic capacitor 1812	0.47uF/50V X7R	C12,C13
204	AE00449	solder material without lead	9308/Sn Ag Cu	
205	RA00242	fixed resistor 1/4W	10KΩ M type	R0
206	HK04594	PC board	P-PM8CTL-DIP	
207	HC00416	connector	2.54 90° 4P	J2
208	HC00417	connector	2.54 90° 10P	J1
209	SB00111	Photodiode	CNY17-3.300(QTC)	U3

No.	Part No.	Description	Specification	Remark
210	HK04595	PC board	P-PM8CTL-SMD	
211	HB01387	PCB	PM8CTL(2*5)_VER041015	
212	CI00012	SMD ceramic capacitor 0805	47PF/50V NPO	C5
213	CI00019	SMD ceramic capacitor 0805	470PF/50V NPO ±5%	C11,C12,C18
214	CI00026	SMD ceramic capacitor 0805	0.0033uF/50V X7R ±10%	C3
215	CI00097	SMD ceramic capacitor 0805	0.027uF/50V X7R ±10%	C10,C13,C14,C16,C6
216	CI00107	SMD ceramic capacitor 0805	270PF/50V NPO ±5%	C8
217	CI00120	SMD ceramic capacitor 1206	0.068uF/25V X7R 50V±10%	C15,C4
218	CI00124	SMD ceramic capacitor 1206	0.47uF/25V Y5V-1206(3216)	C17
219	CI00125	SMD ceramic capacitor 1210	10uF/16V Y5V-1210(3225)	C2
220	CL00003	SMD tantalum capacitor	2.2uF/16V case A	C1
221	RD00232	SMD precise resistor 1/8W	2.20KΩ ±1% 0805	R12
222	RD00239	SMD precise resistor 1/8W	24.0KΩ ±1% 0805	R13
223	RD00507	SMD precise resistor 1/8W	4.30Ω ±1% 0805	R15
224	RD00372	SMD precise resistor 1/8W	10.7Ω ±1% 0805	R16
225	RD00373	SMD precise resistor 1/8W	47.0Ω ±1% 0805	R2
226	RD00374	SMD precise resistor 1/8W	68.0Ω ±1% 0805	R1,R5
227	RD00375	SMD precise resistor 1/8W	75.0Ω ±1% 0805	R18
228	RD00376	SMD precise resistor 1/8W	150Ω ±1% 0805	R7
229	RD00377	SMD precise resistor 1/8W	180Ω ±1% 0805	R14,R17
230	RD00378	SMD precise resistor 1/8W	1.00KΩ ±1% 0805	R19,R20,R3,R4
231	RD00380	SMD precise resistor 1/8W	10.0KΩ ±1% 0805	R8,R11
232	RD00383	SMD precise resistor 1/8W	27.0KΩ ±1% 0805	R9,R10
233	RD00403	SMD precise resistor 1/8W	100KΩ ±1% 0805	R23
234	RD00434	SMD precise resistor 1/8W	19.6KΩ ±1% 0805	R22,R6
235	SE00011	SMD rectifier diode	RLS4148 0.5A (LL-34)	D1
236	SE00032	SMD diode	SS14	D2,D3
237	SE00033	SMD rectifier diode	BAS85(S0D80DC)	D4
238	SG00124	SMD integrated circuit	UC39432BD	U2
239	SG00181	SMD integrated circuit	UCC35701D(TI)	U1
240	RF00005	SMD semi-fixed resistor	20K 3314J-1-203E	VR1
241	AE00449	solder material without lead	9308/Sn Ag Cu	
242	AC00179	tin without lead	M705E Sn 3Ag-0.5Cu	
243	MK00122	spring piece	1.2t*17*16*21(ML000007)_V1.1	D1,M2
244	SB00110	transistor	STW9NB80	M2
245	NC00852	mica-RS	25*40mm	
246	HK05978	PC board	P-D100W-2-DIP(A400.4)	
247	CB00021	electrolytic capacitor	10uF/16V φ4*5mm	C20,C22,C14,C15
248	CB00162	electrolytic capacitor	100uF/35V 105°C TL φ8*11mm	C105,C106
249	CB00164	electrolytic capacitor	2200uF/35V 105°C TL φ16*32mm	C23,C24
250	CF00042	metal-film capacitor MSC	0.47uF/63V 5% CASE02	C18,C21
251	CN00045	fixed inductance	TWLC-220K	L3,L4,L10,L11

No.	Part No.	Description	Specification	Remark
252	CN00069	inductance-EMI SUPPRESSOR	TB36-13-850485	L1,L2
253	ME00015	color nut	3m/m	
254	MF00132	MIC jack	φ3*φ8*0.8t_v1.0	
255	MF00030	washer	φ3.5*φ8*0.8t_V1.0	
256	MJ00067	single light board	0.8t*2135*1220mm 18.69kg	
257	MF00037	washer	φ3.2*φ5.5*1t	
258	MG00357	screw	M3*18	
259	MI02112	heat sink	66*24*8mm D100W-2_V1.0	
260	NI02597	knob	3M#1350Y 10mm*66M	
261	NC00027	mica	ADP 69*19*0.1t_V1.1	
262	HC00324	connect terminal	6.5m/m (PC250)	TE1,TE2,TE6,TE7
263	MG00461	copper pillar	M3*7.3*0.5PH	
264	SD00257	integrated circuit	ADU27_V1.1	U8
265	SD00148	integrated circuit	TDA8927J/N1	
266	CN00149	inductance	WB0610-3.0T	L5,L6
267	HK04125	PC board	P-D100W-2-SMD	
268	HB01240	PCB	D100W-2(2*2)_VER051104	
269	CI00141	SMD ceramic capacitor 1206	0.0027uF/50V X7R ±10%	C151,C152
270	CI00042	SMD ceramic capacitor 1206	0.001uF/50V NPO	C59,C62,C64,C110,C111
271	CI00045	SMD ceramic capacitor 1206	0.022uF/50V X7R ±5%	C40,C41
272	CI00134	SMD ceramic capacitor 1206	0.01uF/50V NPO ±5%	C13,C1,C2
273	CI00136	SMD ceramic capacitor 1206	560PF/50V NPO ±5%	C28,C29,C30,C32,C33,C3
274	CI00138	SMD ceramic capacitor 1206	0.22uF/50V X7R ±10%	C34,C48,C49,C50,C56
275	RD00245	SMD precise resistor 1/4W	1.00KΩ ±1% 1206	R28
276	RD00249	SMD precise resistor 1/4W	5.60KΩ ±1% 1206	R2,R3,R26,R27
277	RD00417	SMD precise resistor 1/4W	27.0KΩ ±1% 1206	R31
278	RD00429	SMD precise resistor 1/4W	5.60Ω ±1% 1206	R39,R40,R41,R42
279	RD00433	SMD precise resistor 1/4W	56.0KΩ ±1% 1206	R1
280	SE00017	SMD zener diode	1/2W 5.6V(RLZ5.6B) LL-34	D8
281	SG00293	integrated circuit	ADU29_V1.1	U6
282	SG00150	SMD integrated circuit	TDA8929T	
283	CI00154	SMD ceramic capacitor 1206	0.1uF/100V X7R ±10%	C6,C55,C5,C7,C60,C61,C8,C10,C45,C47
284	AE00449	solder material without lead	9308/Sn Ag Cu	
285	AC00179	tin without lead	M705E Sn 3Ag-0.5Cu	
286	CF00031	metal-film capacitor	0.1uF/100V	C31,C16,C4,C55,C6
287	RA00184	fixed resistor 1/4W	100Ω M type	R63,R64
288	RA00173	fixed resistor 1/4W	47Ω F type	R65,R66,R68,R70
289	HC00077	connector(male)	3P 2.5mm 180°	CN1
290	NF02317	user manual	A400.4 ALTO_V1.1	
291	NH00149	paper	889*640mm	
292	NB04286	gift carton	A400.4 ALTO_V1.1	

No.	Part No.	Description	Specification	Remark
293	NE14965	label	A400.4_V1.0	
294	NI00014	membrane	0.035*1M	
295	NH00012	bond paper	0.04*1M	
296	MD00608	protective cover	32*32mm	
297	MG00031	screw	M4*12	
298	MG00243	copper pillar	M3*5*0.5PH	
299	HA02522	wire	2P 120mm UL1007 28AWG red black	
300	HE00043	fan	DC12V/0.12A 40*40*15mm 330mm JST2P	
301	HI00289	thermal switch	NO55 U-A	
302	HK04933	PC board	A SERIES CONNECT(500.2)	
303	HB01378	PCB	A SERIES CONNECT PCB VER060112	
304	AC00179	tin without lead	M705E Sn 3Ag-0.5Cu	
305	RA00111	fixed resistor 1/2W	51Ω M type	
306	HC00076	connector(male)	2P 2.5mm 180°	CN3,CN4,CN5
307	HC00077	connector(male)	3P 2.5mm 180°	CN1,CN2
308	CB00064	electrolytic capacitor	470uF/16V φ10*12mm	C1
309	MG00161	screw	M3*6	
310	MG00027	screw	M3*12	
311	HA03501	single terminal wiring	300mm UL1015 18AWG red	
312	HA02911	wire	3P-3P 200mm UL2547 28AWG brown	
313	HA00370	wire	80mm black L5R5	
314	HA03724	wire	90mm UL1015 18AWG	
315	NB04632	cushion	A400.4_V1.0	
316	NB04631	carton	A400.4 ALTO_V1.0	