

Service Manual

Model: ACL4

QUAD/COMPRESSOR/LIMITER



www.altoproaudio.com

Version: 1.1

CONTENTS

- 1. Specification**
- 2. Block Diagram**
- 3. Schematic Diagram**
- 4. Printed Circuit Board**
- 5. Wiring Diagram**
- 6. Test Procedure**
- 7. Electrical Parts List**
- 8. Exploded Views & Mechanical Parts List**
- 9. Troubleshooting**
- 10. Notes**

SPECIFICATIONS FOR ACL4

AUDIO INPUT		
Connectors	XLR and 1/4" TRS (Pin 2 and Tip hot)	
Type	Electronically balanced/unbalanced, RF filtered	
Impedance	Balanced >50Kohm, Unbalanced>25Kohm	
Nominal operating level	+4dBu/-10dBV switchable	
Max input level	>+24dBu balanced and unbalanced	
CMRR	Typically>50dB at 1KHz	

AUDIO OUTPUT		
Connectors	XLR and 1/4" TRS (Pin 2 and Tip hot)	
Type	Electronically balanced/unbalanced, RF filtered	
Impedance	Balanced 120ohm, Unbalanced>60ohm	
Max output level	>+21dBu,+20dBm balanced and unbalanced	

SYSTEM SPECIFICATIONS		
Bandwidth	22HZ to 22KHz, +0/-0.5dB	
Frequency Response	0.35Hz to 200kHz,+0/-3dB	
Noise	>-95dBu, unweighted, 22Hz to 22kHz	
THD	<0.008% Typical at +4dBu, 1kHz, unity gain <0.04% Typical at +20dBu, 1kHz, unity gain	
IMD	<0.1% Typical SMPTE	
Crosstalk	<-100dB, 22Hz to 22Khz	
Stereo Coupling	True RMS detection	

COMPRESSOR SECTION		
Type	Interactive Compressor (Interactive Knee Adaptation)	
Threshold	variable (-40dB to +20dB)	
Ratio	variable (1:1 to ∞:1)	
Threshold Characteristic	variable (Interactive or Hard Knee)	
Manual Attack Time	variable (0.5ms to 100ms / 20dB)	
Manual Release Time	variable from 0.05 ms to 5s / 20dB	
Auto Attack Time	Typical 15ms at 10dB, 5ms at 20dB, 3ms at 30dB	
Auto Release Time	Program dependent, typical 125dB/s	
Output level	variable (-20dB to +20dB)	

PEAK LIMITER SECTION		
Type	Interactive Gain Control Peak Limiter	
Threshold	variable (+4dB to OFF (+22dBu))	
Ratio	∞:1	
Stage 1 Limiter Type	Clipper	
Attack Time	"zero"	
Release Time	"zero"	
Stage 2 Limiter Type	Program Limiter	

Attack	program dependent, typ. <5ms	
Release	Program dependent, typ. 20dB/s	

FUNCTION SWITCHES		
SMART	Enables the “Interactive Knee Adaptation” characteristics.	
CONTOUR	Allows for frequency dependent detection.	
I/O METER	Switches between input and output for the Level Meter.	
BYPASS	Relay controlled hard-bypass	
OPERATING LEVEL	Changes the internal reference level from +4 dBu to –10dBu.	
COUPLE	Linking channels 1&2 or 3&4 for stereo operation. Channel 1 (or 3) becomes master.	

INDICATORS		
GAIN REDUCTION	8 element LED display: 1/3/6/10/15/20/25/30 dB.	
INPUT/OUTPUT LEVEL	8 element LED display: -24/-18/-12/-6/0/+6/+12/+18 dB	
Peak Limiter Threshold	1 LED for indication of limiter function.	
Function switch	LED indicator for each	

POWER SUPPLY		
Mains Voltages	USA/Canada ~120VAC, 60Hz U.K./Australia ~240VAC, 50Hz Europe ~230VAC, 50Hz General Export Model ~100-120VAC, ~200-240VAC, 50-60Hz	
Fuse	100-120VAC : 630mA (SLOW-BLOW) 200-240VAC : 315mA (SLOW-BLOW)	
Power consumption	14Watts	
Mains Connection	Standard IEC receptacle	

PHYSICAL		
Dimension	W(483.0)*D(198.0)*H(44.2) mm	
Net Weight	3.3Kg	

ACL4 BLOCK DIAGRAM

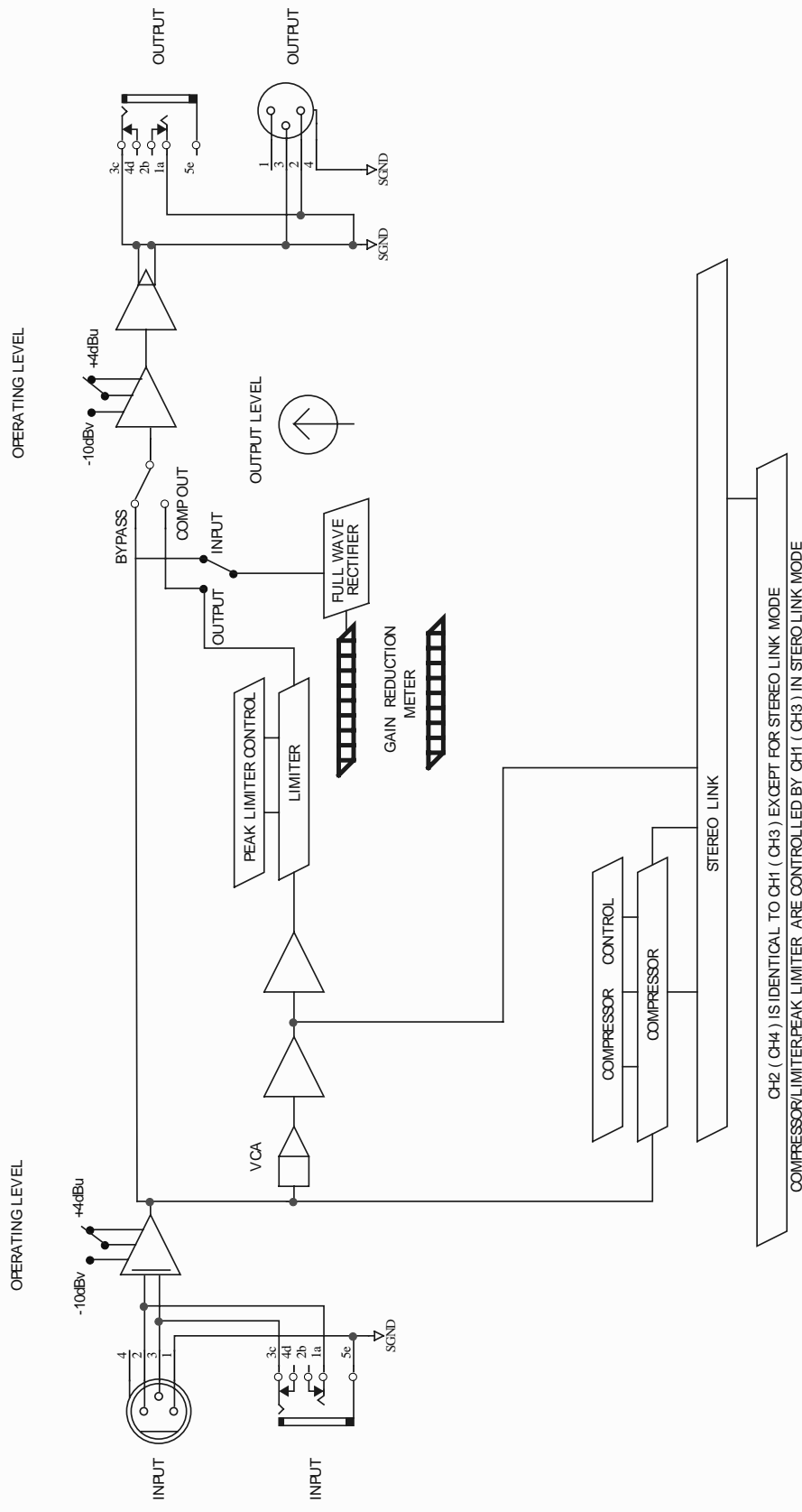

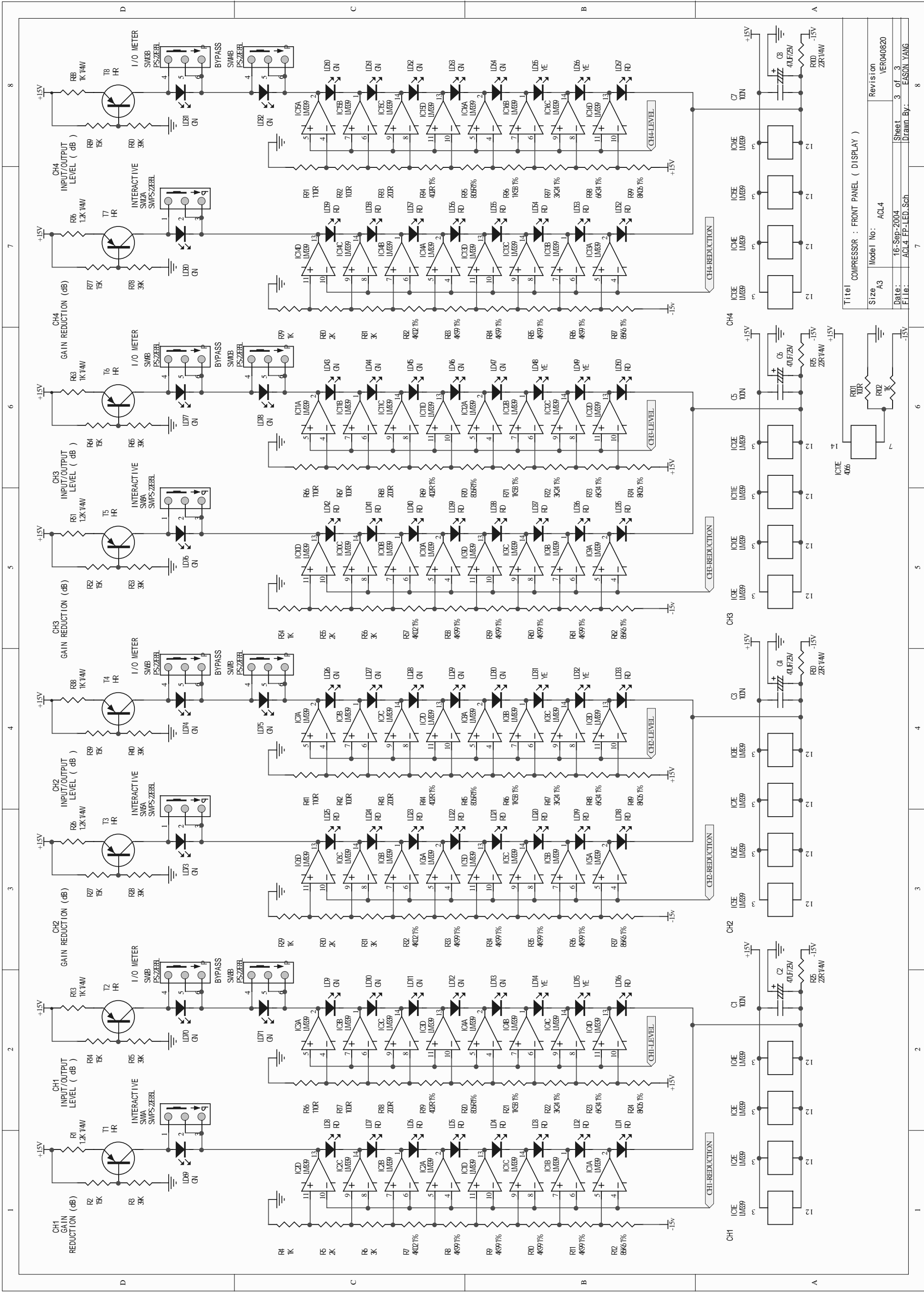

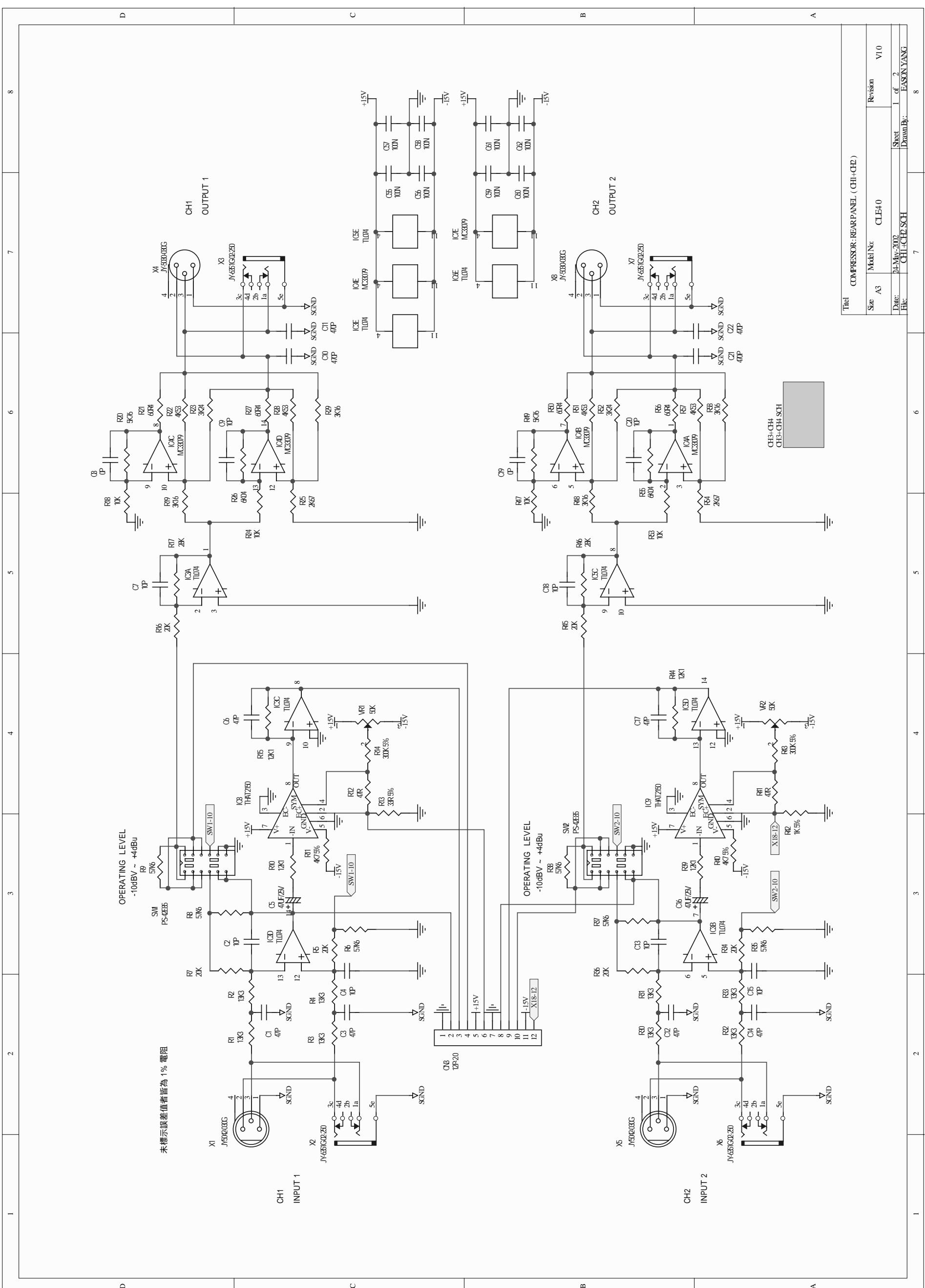

未標示誤差值者皆為 1% 電阻

OPERATING LEVEL
-10dBV ~ +4dBu

OPERATING LEVEL
-10dBV ~ +4dBu

CH1+CH2
CH1+CH2.SCH

COMPRESSOR: REAR PANEL (CH1+CH2)

Size A3 Model No. CLE410 Revision V1.0

Date: 24 May 2002 Sheet 1 of 2

Drawn By: CH1+CH2.SCH EASON YANG

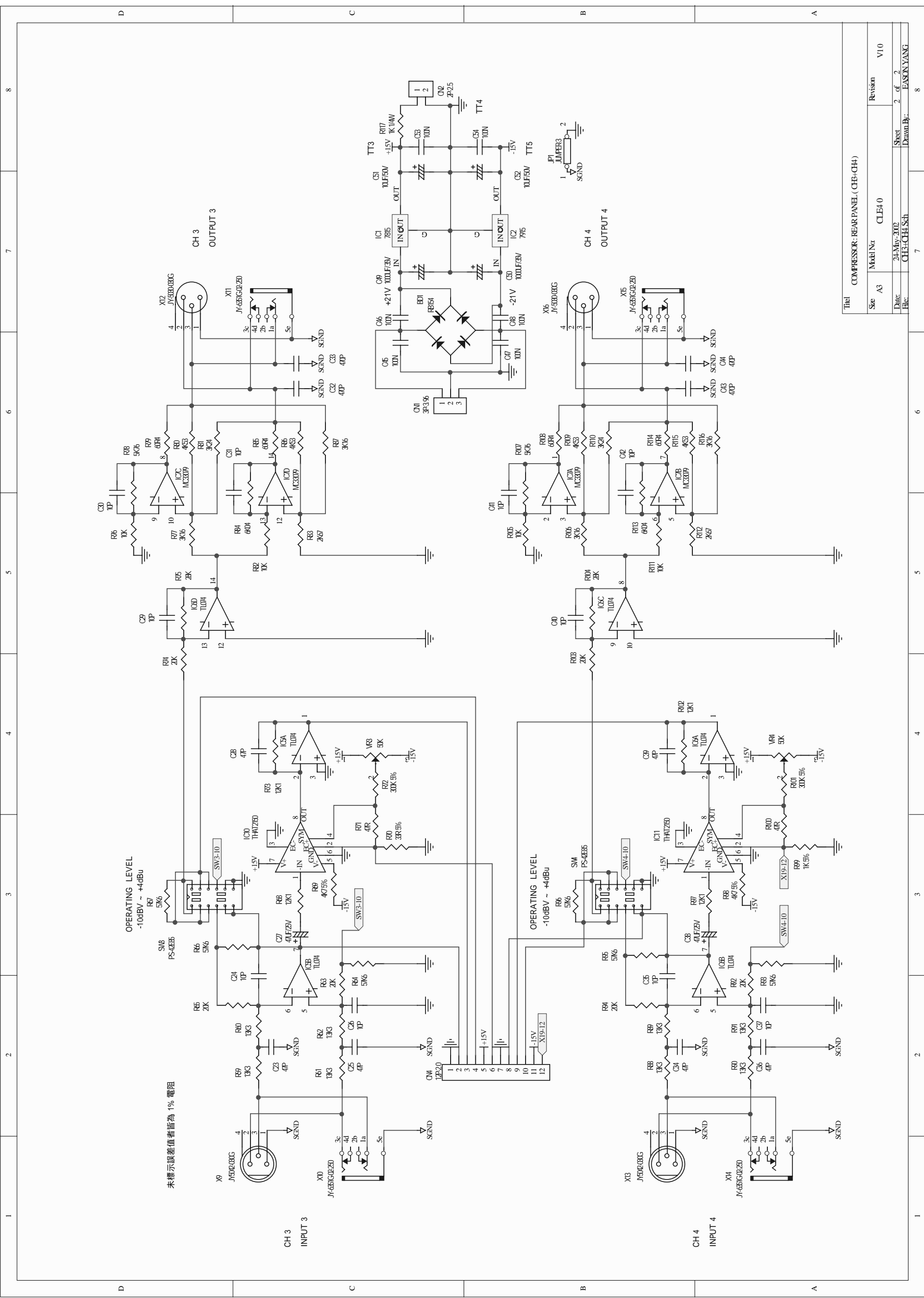

Title		COMPRESSOR: REAR PANEL (CH3-CH4)	
Size	A3	Model No	CLE40
Date	24-May-2002	Sheet	2 of 2
File:	CH3-CH4.Sch	Drawn By:	EASON YANG
		Revision	V10

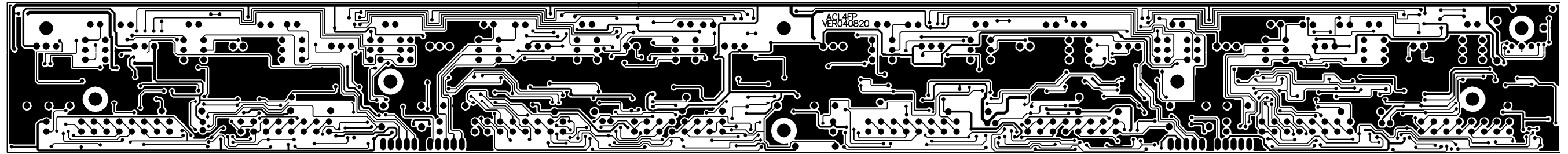

PCB : ACL4-FP Bottom Layer

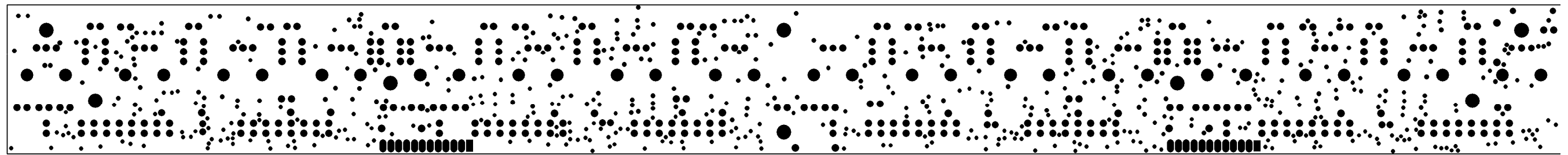

PCB : ACL4-FP Bottom Solder Mask

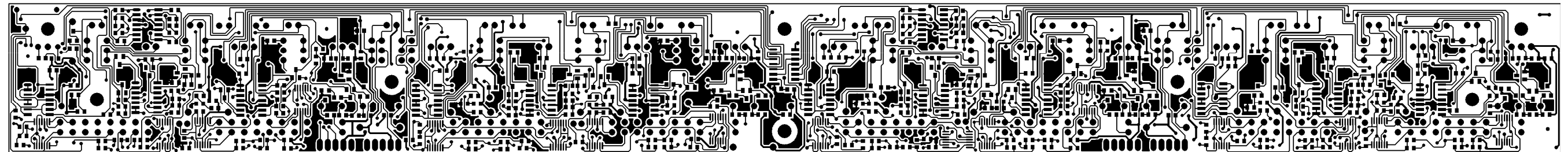

PCB : ACL4-FP TOP Layer

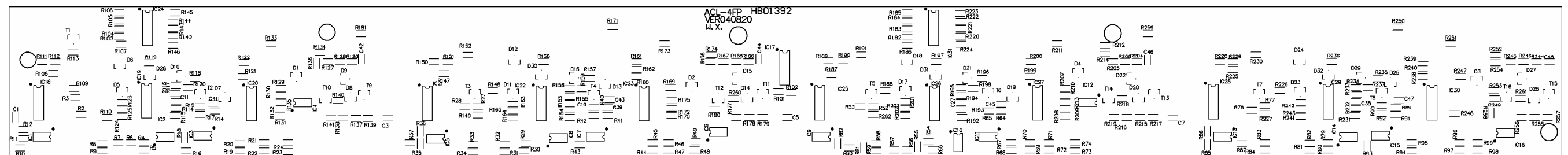

PCB : ACL4-FP Top overlay

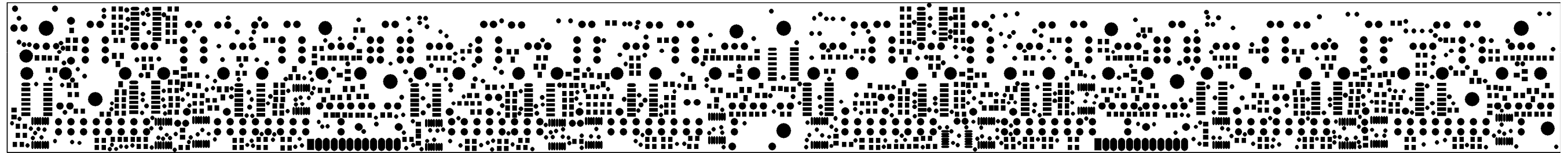

PCB : ACL4-FP TOP Solder Mask

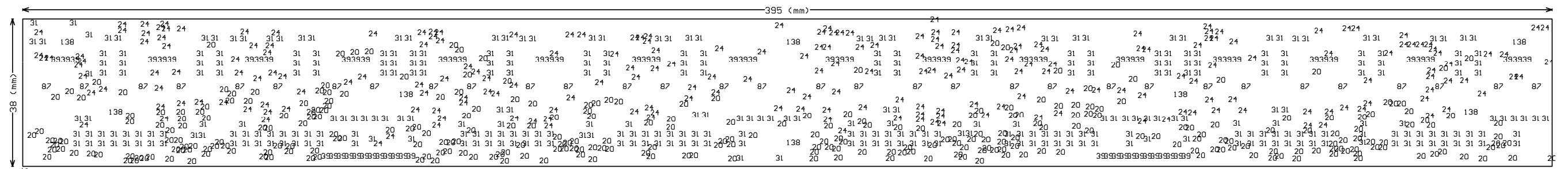

PCB : ACL4-FP Drill Drawing

T Tool	Hole Size	Hole Count	Plated	Tool Travel
T1	20mil (0.508mm)	305		78.74 Inch (2000.02 mm)
T2	24mil (0.6096mm)	232		81.24 Inch (2063.44 mm)
T3	31mil (0.7874mm)	348		88.93 Inch (2258.72 mm)
T4	39mil (0.9906mm)	72		36.14 Inch (917.94 mm)
T5	87mil (2.2098mm)	32		30.52 Inch (775.24 mm)
T6	138mil (3.5052mm)	8	NPTH	44.15 Inch (1121.47 mm)
Totals		997		359.72 Inch (9136.83 mm)

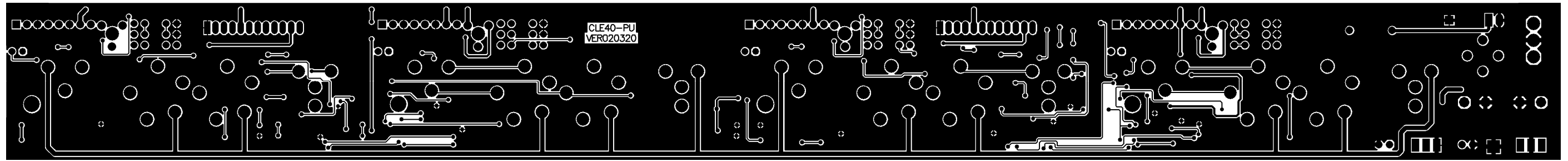

PCB : CLE40-PU Bottom Layer

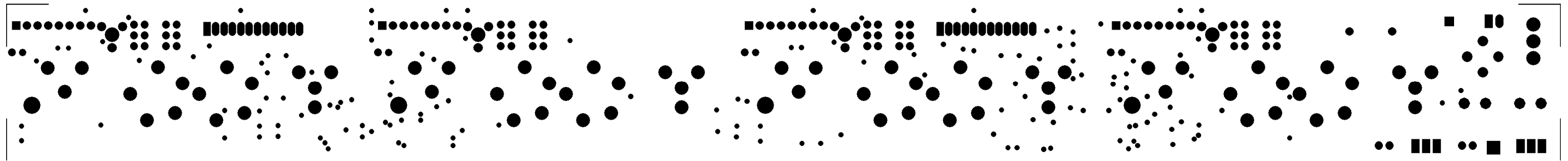

PCB : CLE40-PU Bottom Solder Mask

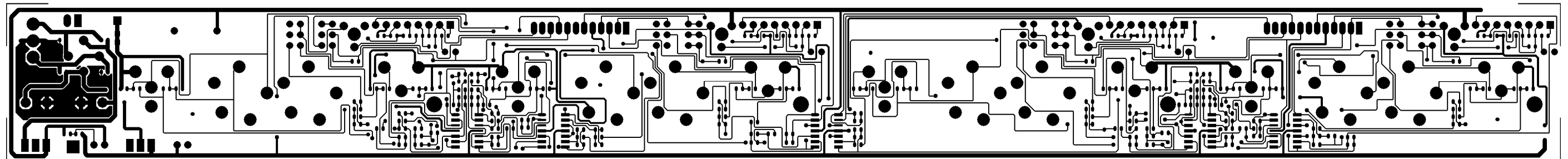

PCB : CLE40-PU TOP Layer

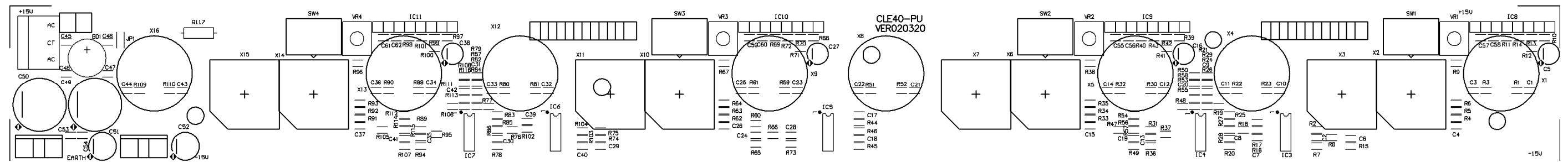

PCB : CLE40-PU Top overlay

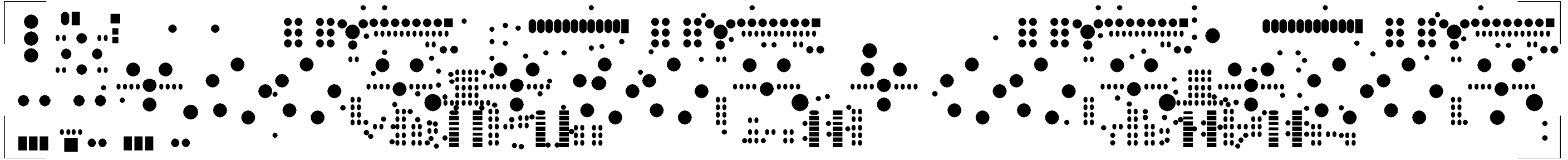

PCB : CLE40-PU TOP Solder Mask

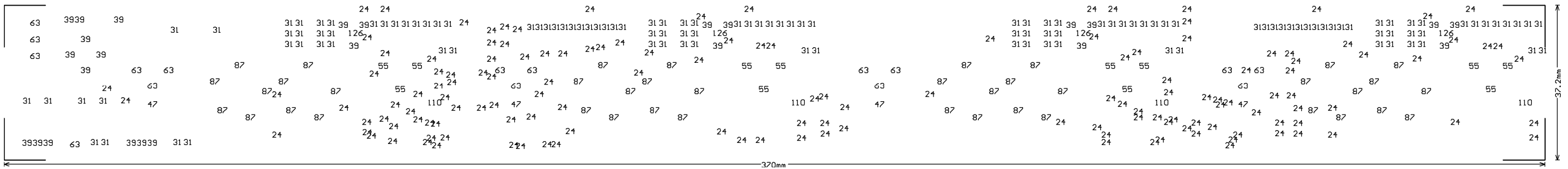

PCB : CLE40-PU Drill Drawing

Tool	Hole Size	Hole Count	Plated	Tool Travel
T1	24mil (0.6096mm)	144		50.95 Inch (1294.10 mm)
T2	31mil (0.7874mm)	122		43.74 Inch (1111.07 mm)
T3	39mil (0.9906mm)	25		35.01 Inch (889.22 mm)
T4	47mil (1.1938mm)	4		17.22 Inch (437.45 mm)
T5	55mil (1.397mm)	12		30.45 Inch (773.34 mm)
T6	63mil (1.6002mm)	16		29.45 Inch (747.94 mm)
T7	87mil (2.2098mm)	40		33.54 Inch (851.88 mm)
T8	110mil (2.794mm)	4		19.43 Inch (493.40 mm)
T9	126mil (3.2004mm)	4	NPTH	28.55 Inch (725.22 mm)
Totals		371		288.33 Inch (7323.62 mm)

ACL4 全機配線圖

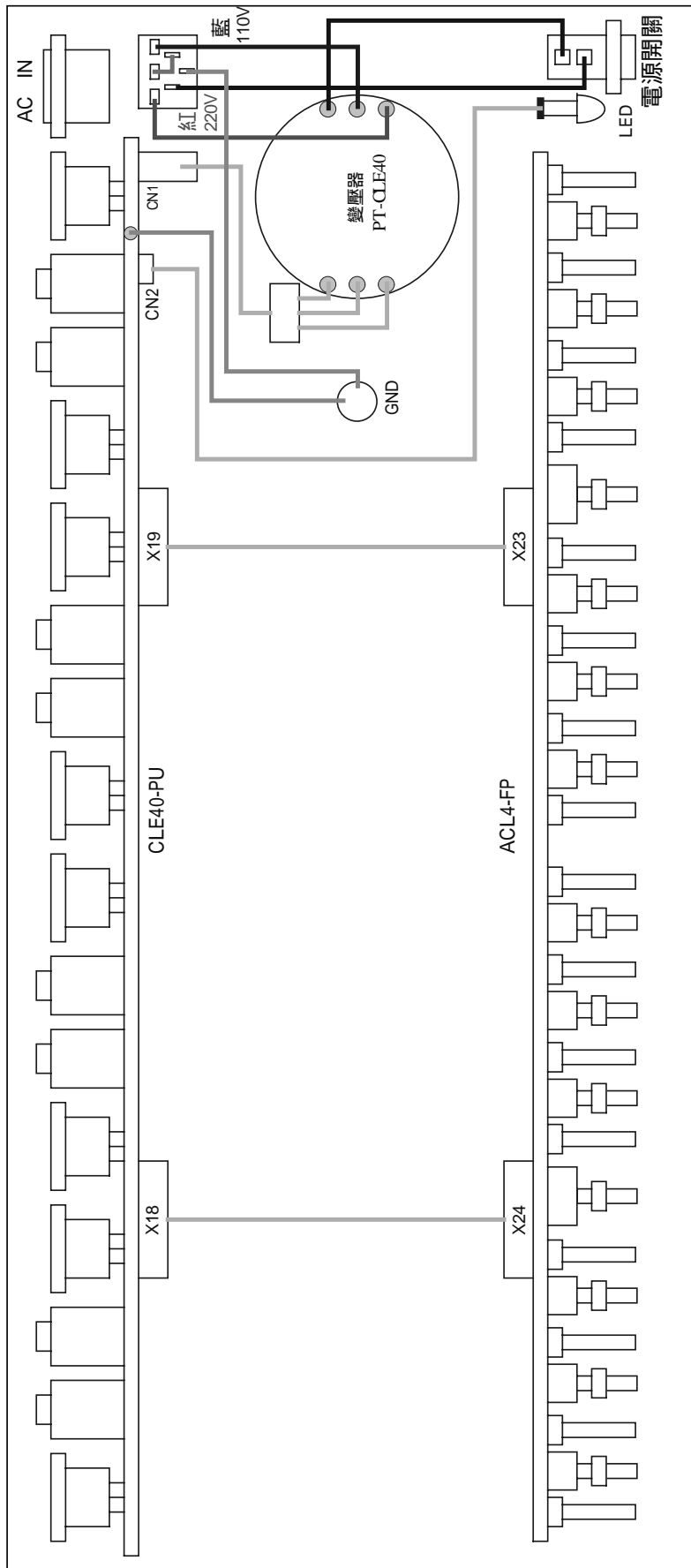

Title		COMPRESSOR ACL4	
Size	Model No:	Revision	VER040820
A4	ACL4		
Date:	16-Sep-2004	Sheet	1 of 1
File:	ACL4_全機配線圖_Sch	Drawn By:	WEN XIANG

Multi-Level BOM Structure Listing

Report No.: IEB0_P02
 Prepared by 030037[蘇文祥]
 Item No. PF01981
 DESCRIPTION: ACL4
 ACL4 ALTO 230V

Version

UNIT: PCS
 Date: 2004/11/06

Date 2004/12/14
 Page No.: 1 / 14

Version	Item No	Loss %	Ver.	Unit	Cardinal	Effective Date
Component Remark	Item Descri				Usage Rate	@:Phantom Layer
					Attrition	Rate
0001-----	MA00080 panel ACL4 ALTO_V1.0			PCS	1.0000 1	2004/11/06 N
0001-----	MA00148 panel ACL4			PCS	1.0000 1	2004/09/27 N
0001-----	MA00128 panel ACL4_V1.0			PCS	1.0000 1	2004/09/27 N
0001-----	MJ00057 AL board 3*2000*1000 16.32kg			PCS KG	1.0000 84 0.00	2004/09/27 N %
0002-----	MB03704 rear board ACL4_V1.1			PCS	1.0000 1	2004/11/06 N
0001-----	MB03698 bottom board ACL4			PCS	1.0000 1	2004/09/27 N
0001-----	MB03697 bottom rear board ACL4_V1.0			PCS	1.0000 1	2004/09/27 N
0001-----	MJ00058 iron board 1*2135*1220 20.45kg			PCS KG	1.0000 12 0.00	2004/09/27 N %
0002-----	ME00032 iron pillar hexagon6.35*M3*5.2			PCS	3.0000 1	2004/09/27 N
0003-----	ME00001 screw pillar M4*10*0.7PH			PCS	1.0000 1	2004/09/27 N
0003-----	MI02537 front board ACL 4 1t*392*41.3*10_V1.0			PCS	1.0000 1	2004/11/17 N
0001-----	ME00035 iron pillar hexagon6.35*M3*6			PCS	8.0000 1	2004/11/26 N
0002-----	MJ00061 Zn-plated board 1*2135*1220 20.45kg			PCS KG	1.0000 95 0.00	2004/11/29 N %
0004-----	MC00649 top cover ACL2_V1.0			PCS	1.0000 1	2004/11/06 N
0001-----	MC00633 top cover ACL2			PCS	1.0000 1	2004/11/12 N
0001-----	MC00632 top cover ACL2_V1.0			PCS	1.0000 1	2004/09/27 N
0001-----	MJ00059 iron board 1.2*2135*1220 24.54kg			PCS KG	1.0000 24 0.00	2004/09/27 N %
0005-----	NI01862 key 5.5*5.5*14.5			PCS	4.0000 1	2004/11/06 N
0006-----	NI01863 key 5.5*W10*7.5			PCS	4.0000 1	2004/11/06 N
0007-----	NI01156 button 3*W6*18.3			PCS	14.0000 1	2004/11/06 N
0008-----	NI03256 knob 9.5*22.75 5445C_V1.0			PCS	4.0000 1	2004/11/06 N
0009-----	NI03257 knob 11.5*25 5445C_V1.0			PCS	12.0000 1	2004/11/06 N

Multi-Level BOM Structure Listing

Report No.: IEB0_P02
 Prepared by 030037[蘇文祥]
 Item No. PF01981
 DESCRIPTION: ACL4
 ACL4 ALTO 230V

Version

UNIT: PCS
 Date: 2004/11/06

Date 2004/12/14
 Page No.: 2 / 14

Version	Item No	Loss %	Ver.	Unit	Cardinal	Effective Date
Component Remark	Item Descri				Usage Rate	@:Phantom Layer Attrition Rate
0010-----	NI03258 knob 7.5*3.3 298C_V1.0			PCS	4.0000 1	2004/11/06 N
0011-----	NI03259 knob 9.2*4.1 298C_V1.0			PCS	12.0000 1	2004/11/06 N
0012-----	HC00015 AC socket (S)315-B (AC select)			PCS	1.0000 1	2004/11/06 N
0013-----	HD00006 glass tube fuse 315mA 250V 5.2*20mm CSA/S/UL/VDE			PCS	1.0000 1	2004/11/06 N
0014-----	NI03251 knob 19.3*19.2*7_V1.0			PCS	1.0000 1	2004/11/06 N
0015-----	NI03252 switch key 32*12.53*14_V1.0			PCS	1.0000 1	2004/11/06 N
0016-----	NI03253 bole 15*15*10.7_V1.0			PCS	1.0000 1	2004/11/06 N
0017-----	MG00025 screw M3*6			PCS	11.0000 1	2004/11/17 N
0018-----	MG00042 screw M3*10			PCS	4.0000 1	2004/11/06 N
0019-----	MG00538 screw M3*10*0.5PH_V1.0			PCS	4.0000 1	2004/11/06 N
0020-----	MF00019 washer 4* 12*1t			PCS	1.0000 1	2004/11/06 N
0021-----	MF00038 washer 4* 7*1t			PCS	2.0000 1	2004/11/06 N
0022-----	ME00015 nut 3m/m			PCS	2.0000 1	2004/11/21 N
0023-----	MG00061 screw M3*10			PCS	16.0000 1	2004/11/06 N
0024-----	MG00041 screw M3*6			PCS	10.0000 1	2004/11/06 N
0025-----	MG00111 screw pill 4*30			PCS	1.0000 1	2004/11/06 N
0026-----	NI00443 rubber coil 20* 60*2tB			PCS	1.0000 1	2004/11/06 N
0027-----	ME00016 nut 4m/m			PCS	2.0000 1	2004/11/06 N
0028-----	ME00060 nut JY-6351G-02-250			PCS	8.0000 1	2004/11/06 N
0029-----	MF00061 washer JY-6351G-02-250			PCS	8.0000 1	2004/11/06 N
0030-----	MF00048 washer 4* 8*0.5t			PCS	2.0000 1	2004/11/06 N
0031-----	MG00281 screw M3*6			PCS	1.0000 1	2004/11/06 N

Multi-Level BOM Structure Listing

Report No.: IEB0_P02
 Prepared by 030037[蘇文祥]
 Item No. PF01981
 DESCRIPTION: ACL4
 ACL4 ALTO 230V

Version

UNIT: PCS
 Date: 2004/11/06

Date 2004/12/14
 Page No.: 3 / 14

Version	Item No	Loss %	Ver.	Unit	Cardinal	Effective Date
Component Remark	Item Descri				Usage Rate	@:Phantom Layer Attrition Rate
0032-----	MG00560 copper pillar M3*24.5*0.5PH 30.5			PCS	1.0000 1	2004/11/06 N
0033-----	MF00037 washer 3* 5*1t			PCS	4.0000 1	2004/12/02 N
0034-----	HA01468 header wiring 2P-2P 300			PCS	1.0000 1	2004/11/21 N
0035-----	HA01835 P.V.C single wave wired UL1617 2 80 brown			PCS	1.0000 1	2004/11/06 N
0036-----	HA01333 single terminal wiring CF:W76 150mm UL1015 18AWG green/yellow			PCS	2.0000 1	2004/11/06 N
0037-----	HA00861 power cord Europe 3P LT-312+LT-501			PCS	1.0000 1	2004/11/06 N
0038-----	NI00252 sleeve 4*20mm			PCS	6.0000 1	2004/11/06 N
0001-----	NI00248 sleeve 4*1000mm			M	20.0000 1000	2002/06/04 N
0039-----	NI00218 cable tie-black ALT-102SB			PCS	3.0000 1	2004/11/06 N
0040-----	NI00501 foot cushion 12.7*9*3t(SF-004)			PCS	4.0000 1	2004/11/06 N
0041-----	NA00137 clip-chain bag 5*7			PCS	1.0000 1	2004/11/06 N
0042-----	NF00061 assurance card ALTO			PCS	1.0000 1	2004/11/06 N
0043-----	NA00279 clip-chain bag 0.04t*100*150mm_V1.0			PCS	1.0000 1	2004/11/06 N
0044-----	AD00011 twin adhesive 90*120mm_V1.0			PCS	1.0000 1	2004/11/06 N
0045-----	HJ00006 desiccant 30g			PCS	1.0000 1	2004/11/06 N
0046-----	NB03223 colour box ACL4 ALTO_V1.0			PCS	1.0000 1	2004/11/06 N
0047-----	NB02163 barrier X23,34,40			PCS	1.0000 1	2004/11/06 N
0048-----	NB02164 barrier X23,34,40			PCS	1.0000 1	2004/11/06 N
0049-----	NB02088 box (1H) ALTO 19"			PCS	1.0000 4	2004/11/06 N
0050-----	TD00118 transformer PT-CLE4.0			PCS	1.0000 1	2004/11/06 N
0051-----	NE13577 label ACL4_V1.0			PCS	4.0000 1	2004/11/06 N
0001-----	NH00012 bond paper 0.04*1M			M	1.0000 80	2004/09/27 N

Multi-Level BOM Structure Listing

Report No.: IEBO_P02
 Prepared by 030037[蘇文祥]
 Item No. PF01981
 DESCRIPTION: ACL4
 ACL4 ALTO 230V

Version

UNIT: PCS
 Date: 2004/11/06

Date 2004/12/14
 Page No.: 4 / 14

Version	Item No Item Descri	Loss %	Ver.	Unit	Cardinal Usage Rate Attrition Rate	Effective Date @:Phantom Layer Rate
0002-----	NI00014 membrane 0.035*1M			M	1.0000 80 0.00 %	2004/09/27 N
0052-----	NE05004 label ALTO			PCS	4.0000 1 0.00 %	2004/11/06 N
0001-----	NH00334 cone paper 0.040*1m			M	1.0000 76 0.00 %	2004/11/29 N
0053-----	HK04590 PC board P-ACL4-FP-DIP			PCS	1.0000 1 0.00 %	2004/11/06 N
0001-----	RA00165 fixed resistor 1/4W 22 M type R100,R25,R50,R75			PCS	4.0000 1 0.00 %	2004/11/06 N
0002-----	RA00209 fixed resistor 1/4W 680 M type R1,R13,R26,R38,R51,R63,R76,R88			PCS	8.0000 1 0.00 %	2004/11/06 N
0003-----	CB00003 electrolytic capacitor 0.22uF/50V 5*11mm C14,C22,C30,C38			PCS	4.0000 1 0.00 %	2004/11/06 N
0004-----	CB00126 electrolytic capacitor 0.33uF/50V 5*11mm C17,C25,C33,C9			PCS	4.0000 1 0.00 %	2004/11/06 N
0005-----	CB00009 electrolytic capacitor 1uF/50V 4*7mm C12,C20,C28,C36			PCS	4.0000 1 0.00 %	2004/11/06 N
0006-----	CB00016 electrolytic capacitor 4.7uF/100V 5*11mm C15,C16,C23,C24,C31,C32,C39,C40			PCS	8.0000 1 0.00 %	2004/11/06 N
0007-----	CB00029 electrolytic capacitor 22uF/35V 5*11mm C10,C18,C26,C34			PCS	4.0000 1 0.00 %	2004/11/06 N
0008-----	CB00039 electrolytic capacitor 47uF/25V 5*11mm C13,C2,C21,C29,C37,C4,C6,C8			PCS	8.0000 1 0.00 %	2004/11/06 N
0009-----	RC00214 potentiometer B1K R0911NOB-V1B102FN00-00 VR10,VR14,VR2,VR6			PCS	4.0000 1 0.00 %	2004/11/06 N
0010-----	RC00213 potentiometer B10K 軸長35 R0911NOB-V1B103FN00-00 VR1,VR11,VR13,VR15,VR3,VR5,VR7,VR9			PCS	8.0000 1 0.00 %	2004/11/06 N

Multi-Level BOM Structure Listing

Report No.: IEBO_P02
 Prepared by 030037[蘇文祥]
 Item No. PF01981
 DESCRIPTION: ACL4
 ACL4 ALTO 230V

Version

UNIT: PCS
 Date: 2004/11/06

Date 2004/12/14
 Page No.: 5 / 14

Version	Item No Item Descri	Loss %	Ver.	Unit	Cardinal Usage Rate Attrition Rate	Effective Date @:Phantom Layer Rate
0011-----	RC00211 potentiometer A20K 軸長35 R0911NOB-V1A203FN00-00 VR12, VR16, VR4, VR8			PCS	4.0000 1 0.00 %	2004/11/06 N
0012-----	HI00162 push-button switch 2 paragraphs 6p PS-22E852L SW1, SW10, SW12, SW13, SW14, SW2, SW3, SW5, SW6, SW7, SW8, SW9			PCS	12.0000 1 0.00 %	2004/11/06 N
0013-----	HI00163 push-button switch 2 stage 12P PS-42E85 SW11, SW4			PCS	2.0000 1 0.00 %	2004/11/06 N
0014-----	HA02078 wire 12P(male)-12P(female) 220 CN1, CN2			PCS	2.0000 1 0.00 %	2004/11/06 N
0015-----	SA00071 L.E.D 3 green LVG2340/A LD69, LD70, LD71, LD73, LD74, LD75, LD76, LD77, LD78, LD80, LD81, LD82			PCS	12.0000 1 0.00 %	2004/11/06 N
0016-----	SA00072 L.E.D 3 red LI2340/A LD72, LD79			PCS	2.0000 1 0.00 %	2004/11/06 N
0017-----	SA00240 L.E.D 3*3(L-714GDT) LD10, LD11, LD12, LD13, LD26, LD27, LD28, LD29, LD30, LD43, LD44, LD45, LD46, LD47, LD60, LD61, LD62, LD63, LD64, LD9			PCS	20.0000 1 0.00 %	2004/11/06 N
0018-----	SA00241 L.E.D 3*3(L-714YD) LD14, LD15, LD31, LD32, LD48, LD49, LD65, LD66			PCS	8.0000 1 0.00 %	2004/11/06 N
0019-----	SA00242 L.E.D 3*3(L-714YD) LD1, LD16, LD17, LD18, LD19, LD2, LD20, LD21, LD22, LD23, LD24, LD25, LD3, LD33, LD34, LD35, LD36, LD37, LD38, LD39, LD4, LD40, LD41, LD42, LD5, LD50, LD51, LD52, LD53, LD54, LD55, LD56, LD57, LD58, LD59, LD6, LD67, LD68, LD7, LD8			PCS	40.0000 1 0.00 %	2004/11/06 N
0020-----	NI01772 LED spacer support LEDS-7 7mm LD69, LD70, LD71, LD72, LD73, LD74, LD75, LD76, LD77, LD78, LD79, LD80, LD81, LD82			PCS	14.0000 1 0.00 %	2004/11/06 N
0021-----	NI03261 separating 38.4*22.5*2.9_V1.0 LD1, LD10, LD11, LD12, LD13, LD14, LD15, LD16, LD17, LD18, LD19, LD2, LD20, LD21, LD22, LD23, LD24, LD25, LD26, LD27, LD28, LD29, LD3, LD30, LD31, LD32, LD33, LD34, LD35, LD36, LD37, LD38, LD39, LD4, LD40, LD41, LD42, LD43, LD44, LD45, LD46, LD47, LD48, LD49,			PCS	8.0000 1 0.00 %	2004/11/06 N

Multi-Level BOM Structure Listing

Report No.: IEBO_P02
 Prepared by 030037[蘇文祥]
 Item No. PF01981
 DESCRIPTION: ACL4
 ACL4 ALTO 230V

Version

UNIT: PCS
 Date: 2004/11/06

Date 2004/12/14
 Page No.: 6 / 14

Version	Item No	Loss %	Ver.	Unit	Cardinal	Effective Date
Component Remark	Item Descri				Usage Rate	@:Phantom Layer Attrition Rate
						LD5, LD50, LD51, LD52, LD53, LD54, LD55, LD56, LD57, LD58, LD59, LD6, LD60, LD61, LD62, LD63, LD64, LD65, LD66, LD67, LD68, LD7, LD8, LD9
0022-----	HK04591 PC board P-ACL4-FP-SMD			PCS	1.0000 1	2004/11/06 N
0001-----	HB01392 PCB			PCS	1.0000 1	2004/11/06 N
0002-----	ACL4-FP(1*2)_VER040820 RD00279 SMD precise resistor 1/10W 402 ±1% 0603 R19, R44, R69, R94			PCS	4.0000 1 0.00	2004/11/06 N %
0003-----	RD00281 SMD precise resistor 1/10W 806 ±1% 0603 R20, R45, R70, R95			PCS	4.0000 1 0.00	2004/11/06 N %
0004-----	RD00201 SMD precise resistor 1/10W 1.50K ±1% 0603 R130, R171, R210, R250			PCS	4.0000 1 0.00	2004/11/06 N %
0005-----	RD00283 SMD precise resistor 1/10W 1.58K ±1% 0603 R21, R46, R71, R96			PCS	4.0000 1 0.00	2004/11/06 N %
0006-----	RD00285 SMD precise resistor 1/10W 3.24K ±1% 0603 R22, R47, R72, R97			PCS	4.0000 1 0.00	2004/11/06 N %
0007-----	RD00364 SMD precise resistor 1/10W 4.02K ±1% 0603 R32, R57, R7, R82			PCS	4.0000 1 0.00	2004/11/06 N %
0008-----	RD00209 SMD precise resistor 1/10W 4.99K ±1% 0603 R10, R11, R33, R34, R35, R36, R58, R59, R60, R61, R8, R83, R84, R85, R86, R9			PCS	16.0000 1 0.00	2004/11/06 N %
0009-----	RD00287 SMD precise resistor 1/10W 6.34K ±1% 0603 R23, R48, R73, R98			PCS	4.0000 1 0.00	2004/11/06 N %
0010-----	RD00289 SMD precise resistor 1/10W 8.06K ±1% 0603 R24, R49, R74, R99			PCS	4.0000 1 0.00	2004/11/06 N %
0011-----	RD00293 SMD precise resistor 1/10W 17.4K ±1% 0603 R104, R143, R221, R183			PCS	4.0000 1 0.00	2004/11/06 N %

Multi-Level BOM Structure Listing

Report No.: IEBO_P02
 Prepared by 030037[蘇文祥]
 Item No. PF01981
 DESCRIPTION: ACL4
 ACL4 ALTO 230V

Version

UNIT: PCS
 Date: 2004/11/06

Date 2004/12/14
 Page No.: 7 / 14

Version	Item No	Loss %	Ver.	Unit	Cardinal	Effective Date
Component Remark	Item Descri				Usage Rate	@:Phantom Layer Attrition Rate
0012-----	RD00294 SMD precise resistor 1/10W 24.9K ±1% 0603 R105,R144,R184,R222			PCS	4.0000 1 0.00 %	2004/11/06 N
0013-----	RD00295 SMD precise resistor 1/10W 86.6K ±1% 0603 R12,R37,R62,R87			PCS	4.0000 1 0.00 %	2004/11/06 N
0014-----	RD00296 SMD precise resistor 1/10W 523K ±1% 0603 R129,R169,R207,R247			PCS	4.0000 1 0.00 %	2004/11/06 N
0015-----	RD00059 SMD fixed resistor 1/10W 0.0 ±5% 0603 R103,R142,R182,R220			PCS	4.0000 1 0.00 %	2004/11/06 N
0016-----	RD00304 SMD fixed resistor 1/10W 33 ±5% 0603 R162,R240			PCS	2.0000 1 0.00 %	2004/11/06 N
0017-----	RD00068 SMD fixed resistor 1/10W 100 ±5% 0603 R101,R17,R42,R67,R92			PCS	5.0000 1 0.00 %	2004/11/06 N
0018-----	RD00305 SMD fixed resistor 1/10W 110 ±5% 0603 R16,R41,R66,R91			PCS	4.0000 1 0.00 %	2004/11/06 N
0019-----	RD00072 SMD fixed resistor 1/10W 200 ±5% 0603 R18,R43,R68,R93			PCS	4.0000 1 0.00 %	2004/11/06 N
0020-----	RD00078 SMD fixed resistor 1/10W 470 ±5% 0603 R127,R167,R205,R245			PCS	4.0000 1 0.00 %	2004/11/06 N
0021-----	RD00080 SMD fixed resistor 1/10W 680 ±5% 0603 R121,R160,R199,R238			PCS	4.0000 1 0.00 %	2004/11/06 N
0022-----	RD00083 SMD fixed resistor 1/10W 1.0K ±5% 0603 R102,R117,R119,R125,R156,R158,R165,R195,R197,R203, R234,R236,R243,R29,R4,R54,R79			PCS	17.0000 1 0.00 %	2004/11/06 N
0023-----	RD00087 SMD fixed resistor 1/10W 2.0K ±5% 0603 R116,R155,R194,R233,R30,R5,R55,R80			PCS	8.0000 1 0.00 %	2004/11/06 N

Multi-Level BOM Structure Listing

Report No.: IEBO_P02
 Prepared by 030037[蘇文祥]
 Item No. PF01981
 DESCRIPTION: ACL4
 ACL4 ALTO 230V

Version

UNIT: PCS
 Date: 2004/11/06

Date 2004/12/14
 Page No.: 8 / 14

Version	Item No	Loss %	Ver.	Unit	Cardinal	Effective Date
Component Remark	Item Descri				Usage Rate	@:Phantom Layer Attrition Rate
0024-----	RD00088 SMD fixed resistor 1/10W 2.2K ±5% 0603 R120, R137, R138, R159, R177, R178, R198, R215, R216, R237, R255, R256			PCS	12.0000 1 0.00 %	2004/11/06 N
0025-----	RD00090 SMD fixed resistor 1/10W 3.0K ±5% 0603 R115, R154, R181, R192, R231, R259, R31, R56, R6, R81			PCS	10.0000 1 0.00 %	2004/11/06 N
0026-----	RD00092 SMD fixed resistor 1/10W 3.9K ±5% 0603 R122, R141, R161, R180, R200, R219, R239, R258			PCS	8.0000 1 0.00 %	2004/11/06 N
0027-----	RD00093 SMD fixed resistor 1/10W 4.7K ±5% 0603 R140, R218, R260, R261			PCS	4.0000 1 0.00 %	2004/11/06 N
0028-----	RD00096 SMD fixed resistor 1/10W 6.2K ±5% 0603 R112, R151, R190, R229			PCS	4.0000 1 0.00 %	2004/11/06 N
0029-----	RD00097 SMD fixed resistor 1/10W 6.8K ±5% 0603 R111, R150, R189, R228			PCS	4.0000 1 0.00 %	2004/11/06 N
0030-----	RD00101 SMD fixed resistor 1/10W 10K ±5% 0603 R118, R126, R157, R166, R196, R204, R235, R244			PCS	8.0000 1 0.00 %	2004/11/06 N
0031-----	RD00103 SMD fixed resistor 1/10W 15K ±5% 0603 R14, R2, R27, R39, R52, R64, R77, R89			PCS	8.0000 1 0.00 %	2004/11/06 N
0032-----	RD00306 SMD fixed resistor 1/10W 20K ±5% 0603 R133, R173, R211, R251			PCS	4.0000 1 0.00 %	2004/11/06 N
0033-----	RD00109 SMD fixed resistor 1/10W 39K ±5% 0603 R15, R28, R3, R40, R53, R65, R78, R90			PCS	8.0000 1 0.00 %	2004/11/06 N
0034-----	RD00110 SMD fixed resistor 1/10W 43K ±5% 0603 R114, R153, R193, R232			PCS	4.0000 1 0.00 %	2004/11/06 N
0035-----	RD00111 SMD fixed resistor 1/10W 47K ±5% 0603 R106, R107, R123, R124, R131, R132, R134, R135, R145, R146, R163, R164, R170, R172, R174, R175, R185, R186, R201, R202, R208, R209, R212, R213, R223, R224, R241, R242, R248, R249, R252, R253			PCS	32.0000 1 0.00 %	2004/11/06 N

Multi-Level BOM Structure Listing

Report No.: IEBO_P02
 Prepared by 030037[蘇文祥]
 Item No. PF01981
 DESCRIPTION: ACL4
 ACL4 ALTO 230V

Version

UNIT: PCS
 Date: 2004/11/06

Date 2004/12/14
 Page No.: 9 / 14

Version	Item No Item Descri	Loss %	Ver.	Unit	Cardinal Usage Rate Attrition Rate	Effective Date @:Phantom Layer Rate
0036-----	RD00120 SMD fixed resistor 1/10W 240K ±5% 0603 R113,R152,R191,R230			PCS	4.0000 1 0.00 %	2004/11/06 N
0037-----	RD00307 SMD fixed resistor 1/10W 560K ±5% 0603 R128,R168,R206,R246			PCS	4.0000 1 0.00 %	2004/11/06 N
0038-----	RD00125 SMD fixed resistor 1/10W 1.0M ±5% 0603 R139,R179,R217,R257			PCS	4.0000 1 0.00 %	2004/11/06 N
0039-----	RD00127 SMD fixed resistor 1/10W 2.7M ±5% 0603 R109,R148,R188,R226			PCS	4.0000 1 0.00 %	2004/11/06 N
0040-----	RD00308 SMD fixed resistor 1/10W 4.7M ±5% 0603 R136,R176,R214,R254			PCS	4.0000 1 0.00 %	2004/11/06 N
0041-----	RD00309 SMD fixed resistor 1/10W 10M ±5% 0603 R108,R110,R147,R149,R187,R225,R227,R262			PCS	8.0000 1 0.00 %	2004/11/06 N
0042-----	CI00059 SMD ceramic capacitor 0603 100PF/50V NPO ±5% C11,C19,C27,C35			PCS	4.0000 1 0.00 %	2004/11/06 N
0043-----	CI00075 SMD ceramic capacitor 0603 0.1uF/50V Y5V +80,-20% C1,C3,C41,C42,C43,C44,C45,C46,C47,C48,C5,C7			PCS	12.0000 1 0.00 %	2004/11/06 N
0044-----	SE00010 SMD rectifier diode BAS16(SOT-23) D10,D11,D16,D17,D21,D23,D28,D29,D30,D31,D32,D5			PCS	12.0000 1 0.00 %	2004/11/06 N
0045-----	SE00009 SMD rectifier diode DAN202K/T-146 D14,D15,D20,D22,D26,D27,D8,D9			PCS	8.0000 1 0.00 %	2004/11/06 N
0046-----	SE00008 SMD rectifier diode DA204K/T-146 D1,D12,D13,D18,D19,D2,D24,D25,D3,D4,D6,D7			PCS	12.0000 1 0.00 %	2004/11/06 N
0047-----	SF00010 SMD transistor 2SC2412K(SOT-23)/(R) T10,T11,T12,T13,T14,T15,T16,T9			PCS	8.0000 1 0.00 %	2004/11/06 N

Multi-Level BOM Structure Listing

Report No.: IEBO_P02
 Prepared by 030037[蘇文祥]
 Item No. PF01981
 DESCRIPTION: ACL4
 ACL4 ALTO 230V

Version

UNIT: PCS
 Date: 2004/11/06

Date 2004/12/14
 Page No.: 10 / 14

Version	Item No Item Descri	Loss %	Ver.	Unit	Cardinal Usage Rate Attrition Rate	Effective Date @:Phantom Layer Rate
0048-----	SF00004 SMD transistor 2SA1036K(SOT-23)/(R) T1,T2,T3,T4,T5,T6,T7,T8			PCS	8.0000 1 0.00 %	2004/11/06 N
0049-----	SG00107 SMD integrated circuit TL064CDT IC19, IC20, IC22, IC23, IC24, IC26, IC27, IC29, IC30, IC31			PCS	10.0000 1 0.00 %	2004/11/06 N
0050-----	SG00116 SMD integrated circuit BA1033FV E2 IC1, IC10, IC11, IC12, IC13, IC14, IC15, IC16, IC2, IC3, IC4, IC5, IC6, IC7, IC8, IC9			PCS	16.0000 1 0.00 %	2004/11/06 N
0051-----	SG00119 SMD integrated circuit CA3086M96 IC18, IC21, IC25, IC28			PCS	4.0000 1 0.00 %	2004/11/06 N
0052-----	SG00044 SMD integrated circuit BU4066F IC17			PCS	1.0000 1 0.00 %	2004/11/06 N
0054-----	HK04592 PC board P-CLE4.0-PU-DIP(ACL4)			PCS	1.0000 1 0.00 %	2004/11/06 N
0001-----	RA00217 fixed resistor 1/4W 1.5K M type R117			PCS	1.0000 1 0.00 %	2004/12/02 N
0002-----	CB00025 electrolytic capacitor 10uF/50V 6*7mm C51,C52			PCS	2.0000 1 0.00 %	2004/11/06 N
0003-----	CB00039 electrolytic capacitor 47uF/25V 5*11mm C16,C27,C38,C5			PCS	4.0000 1 0.00 %	2004/11/06 N
0004-----	CB00073 electrolytic capacitor 1000uF/35V 13*20mm C49,C50			PCS	2.0000 1 0.00 %	2004/11/06 N
0005-----	SA00001 bridge rectifier 1A/400V RB154 BS1			PCS	1.0000 1 0.00 %	2004/11/06 N
0006-----	SD00015 integrated circuit THAT2150A IC10, IC11, IC8, IC9			PCS	4.0000 1 0.00 %	2004/11/06 N
0007-----	HI00163 push-button switch 2 stage 12P PS-42E85 SW1, SW2, SW3, SW4			PCS	4.0000 1 0.00 %	2004/11/06 N

Multi-Level BOM Structure Listing

Report No.: IEB0_P02
 Prepared by 030037[蘇文祥]
 Item No. PF01981
 DESCRIPTION: ACL4
 ACL4 ALTO 230V

Version

UNIT: PCS
 Date: 2004/11/06

Date 2004/12/14
 Page No.: 11 / 14

Version	Item No Item Descri	Loss %	Ver.	Unit	Cardinal Usage Rate	Effective Date @:Phantom Layer Attrition Rate
0008-----	HC00126 XLR MIC jack JY-5042-030G female plug 180° X1,X13,X5,X9			PCS	4.0000 1 0.00 %	2004/11/06 N
0009-----	HC00125 MIC jack JY-6351G-02-250 X10,X11,X14,X15,X2,X3,X6,X7			PCS	8.0000 1 0.00 %	2004/11/06 N
0010-----	HC00076 row-wire header(male) 2P 2.5mm 180° CN2			PCS	1.0000 1 0.00 %	2004/11/06 N
0011-----	HC00089 row-wire header(male) 3P 3.9mm 180° CN1			PCS	1.0000 1 0.00 %	2004/11/06 N
0012-----	HC00261 row-wire header(male) 12P 2.0mm 180° CN3,CN4			PCS	2.0000 1 0.00 %	2004/11/06 N
0013-----	RC00171 resistor 50K 6 EVND8A VR1,VR2,VR3,VR4			PCS	4.0000 1 0.00 %	2004/11/06 N
0014-----	HC00392 XLR MIC jack JY-5030-030G 180° X12,X16,X4,X8			PCS	4.0000 1 0.00 %	2004/11/06 N
0015-----	HK00312 PC board P-CLE4.0-PU-SMD			PCS	1.0000 1 0.00 %	2004/11/06 N
0001-----	HB00634 PCB CLE4.0-PU(1*4)_VER041012			PCS	1.0000 1 0.00 %	2002/04/14 N
0002-----	RD00298 SMD precise resistor 1/10W 47.0 ±1% 0603 R100,R12,R41,R71			PCS	4.0000 1 0.00 %	2002/04/14 N
0003-----	RD00297 SMD precise resistor 1/10W 60.4 ±1% 0603 R108,R114,R21,R27,R50,R56,79,85			PCS	8.0000 1 0.00 %	2002/04/14 N
0004-----	RD00271 SMD precise resistor 1/10W 2.67K ±1% 0603 R112,R25,54,83			PCS	4.0000 1 0.00 %	2002/04/14 N
0005-----	RD00363 SMD precise resistor 1/10W 3.16K ±1% 0603 R106,R116,R19,R29,R48,R58,77,87			PCS	8.0000 1 0.00 %	2002/10/07 N

Multi-Level BOM Structure Listing

Report No.: IEBO_P02
 Prepared by 030037[蘇文祥]
 Item No. PF01981
 DESCRIPTION: ACL4
 ACL4 ALTO 230V

Version

UNIT: PCS
 Date: 2004/11/06

Date 2004/12/14
 Page No.: 12 / 14

Version	Item No Item Descri	Loss %	Ver.	Unit	Cardinal Usage Rate Attrition Rate	Effective Date @:Phantom Layer Rate
0006-----	RD00285 SMD precise resistor 1/10W 3.24K ±1% 0603 R110,R23,R52,R81			PCS	4.0000 1 0.00 %	2002/04/14 N
0007-----	RD00286 SMD precise resistor 1/10W 4.53K ±1% 0603 R109,R115,R22,R28,R51,R57,R80,R86			PCS	8.0000 1 0.00 %	2002/04/14 N
0008-----	RD00299 SMD precise resistor 1/10W 5.76K ±1% 0603 R107,R20,R49,R78			PCS	4.0000 1 0.00 %	2002/04/14 N
0009-----	RD00300 SMD precise resistor 1/10W 6.04K ±1% 0603 R113,R26,R55,R84			PCS	4.0000 1 0.00 %	2002/04/14 N
0010-----	RD00214 SMD precise resistor 1/10W 10.0K ±1% 0603 R105,R111,R18,R24,R47,R53,R76,R82			PCS	8.0000 1 0.00 %	2002/04/14 N
0011-----	RD00301 SMD precise resistor 1/10W 12.1K ±1% 0603 R10,R102,R15,R39,R44,R68,R73,R97			PCS	8.0000 1 0.00 %	2002/04/14 N
0012-----	RD00216 SMD precise resistor 1/10W 13.3K ±1% 0603 R1,R2,R3,R30,R31,R32,R33,R4,R59,R60,R61,R62,R88,R89, R90,R91			PCS	16.0000 1 0.00 %	2002/04/14 N
0013-----	RD00219 SMD precise resistor 1/10W 20.0K ±1% 0603 R103,R16,R34,R36,R45,R5,R63,R65,R7,R74,R92,R94			PCS	12.0000 1 0.00 %	2002/04/14 N
0014-----	RD00302 SMD precise resistor 1/10W 28.0K ±1% 0603 R104,R17,R46,R75			PCS	4.0000 1 0.00 %	2002/04/14 N
0015-----	RD00303 SMD precise resistor 1/10W 57.6K ±1% 0603 R35,R37,R38,R6,R64,R66,R67,R8,R9,R93,R95,R96			PCS	12.0000 1 0.00 %	2002/04/14 N
0016-----	RD00304 SMD fixed resistor 1/10W 33 ±5% 0603 R13,R70			PCS	2.0000 1 0.00 %	2002/04/14 N
0017-----	RD00083 SMD fixed resistor 1/10W 1.0K ±5% 0603 R42,R99			PCS	2.0000 1 0.00 %	2002/04/14 N

Multi-Level BOM Structure Listing

Report No.: IEBO_P02
 Prepared by 030037[蘇文祥]
 Item No. PF01981
 DESCRIPTION: ACL4
 ACL4 ALTO 230V

Version

UNIT: PCS
 Date: 2004/11/06

Date 2004/12/14
 Page No.: 13 / 14

Version	Item No Item Descri	Loss %	Ver.	Unit	Cardinal Usage Rate @: Attrition Rate	Effective Date Phantom Layer Rate
0018-----	RD00093 SMD fixed resistor 1/10W 4.7K ±5% 0603 R11,R40,R69,R98			PCS	4.0000 1 0.00 %	2002/04/14 N
0019-----	RD00268 SMD fixed resistor 1/10W 300K ±5% 0603 R101,R14,R43,R72			PCS	4.0000 1 0.00 %	2002/04/14 N
0020-----	CI00047 SMD ceramic capacitor 0603 10PF/50V NPO ±5% C13,C15,C18,C19,C2,C20,C24,C26,C29,C30,C31,C35,C37,C4, C40,C41,C42,C7,C8,C9			PCS	20.0000 1 0.00 %	2002/04/14 N
0021-----	CI00055 SMD ceramic capacitor 0603 47PF/50V NPO ±5% C1,C12,C14,C17,C23,C25,C28,C3,C34,C36,C39,C6			PCS	12.0000 1 0.00 %	2002/04/14 N
0022-----	CI00063 SMD ceramic capacitor 0603 470PF/50V NPO ±5 % C10,C11,C21,C22,C32,C33,C43,C44			PCS	8.0000 1 0.00 %	2002/04/14 N
0023-----	CI00075 SMD ceramic capacitor 0603 0.1uF/50V Y5V +80,-20% C45,C46,C47,C48,C53,C54,C55,C56,C57,C58,C59,C60,C61, C62			PCS	14.0000 1 0.00 %	2004/02/25 N
0024-----	SG00118 SMD integrated circuit MC33079DT(ST)MC33079D(ON) IC4,IC7			PCS	2.0000 1 0.00 %	2002/04/14 N
0025-----	SG00001 SMD integrated circuit TL074CDT IC3,IC5,IC6			PCS	3.0000 1 0.00 %	2002/04/14 N
0055-----	HK04585 PC board P-ACL2PWRSW			PCS	1.0000 1 0.00 %	2004/11/06 N
0001-----	HB01389 PCB ACL2PWRSW(1*10)_VER041122			PCS	1.0000 1 0.00 %	2004/11/06 N
0002-----	HI00023 power switch SDDL1007U SW1			PCS	1.0000 1 0.00 %	2004/11/06 N
0003-----	SA00185 diode 3 blue (6554-TLHB4400) LD1			PCS	1.0000 1 0.00 %	2004/12/02 N
0004-----	HC00076 row-wire header(male) 2P 2.5mm 180° CN1			PCS	1.0000 1 0.00 %	2004/11/06 N

Multi-Level BOM Structure Listing

Report No.: IEB0_P02
 Prepared by 030037[蘇文祥]
 Item No. PF01981
 DESCRIPTION: ACL4
 ACL4 ALTO 230V

Version

UNIT: PCS
 Date: 2004/11/06

Date 2004/12/14
 Page No.: 14 / 14

Version	Item No Item Descri	Loss %	Ver.	Unit	Cardinal Usage Rate @: Attrition Rate	Effective Date @:Phantom Layer Rate
0005-----	HA01798 wire 250 black			PCS	1.0000 1	2004/11/06 N
0006-----	HA01925 jumper wire 10mm R1			PCS	1.0000 1	2004/11/06 N
0001-----	HA02249 wire 0.6			M KG	0.0200 1 0.00	2004/08/05 N %
0056-----	NF01956 instruction ACL4 ALTO_V1.0			PCS	1.0000 1	2004/11/06 N
0001-----	NH00149 paper 889*640mm			張 令	0.5000 1	2004/11/12 Y
0057-----	NA00123 PE bag 0.04t*580*300mm			PCS KG	1.0000 1 0.00	2004/12/03 %
0058-----	SD00077 integrated circuit L7815CV(TO-220)(ST) IC1			PCS	1.0000 1	2004/12/03 %
0059-----	SD00079 integrated circuit L7915CV(TO-220)(ST) IC2			PCS	1.0000 1	2004/12/03 %
0060-----	MG00162 screw M3*8			PCS	2.0000 1	2004/12/03 %
0061-----	NI02249 insulate bean TW-1(TO-220)			PCS	2.0000 1	2004/12/03 %
0062-----	MJ00123 heat-sink(white) 65*18*4 SCX-P234			PCS	1.0000 1	2004/12/03 %
0001-----	MJ00115 heat-sink CLE2.0 4*80.5*18_V1.1			PCS	1.0000 1	2004/09/23 N
0063-----	NC00005 silicone insulator TO-220 square type			PCS	2.0000 1	2004/12/03 %

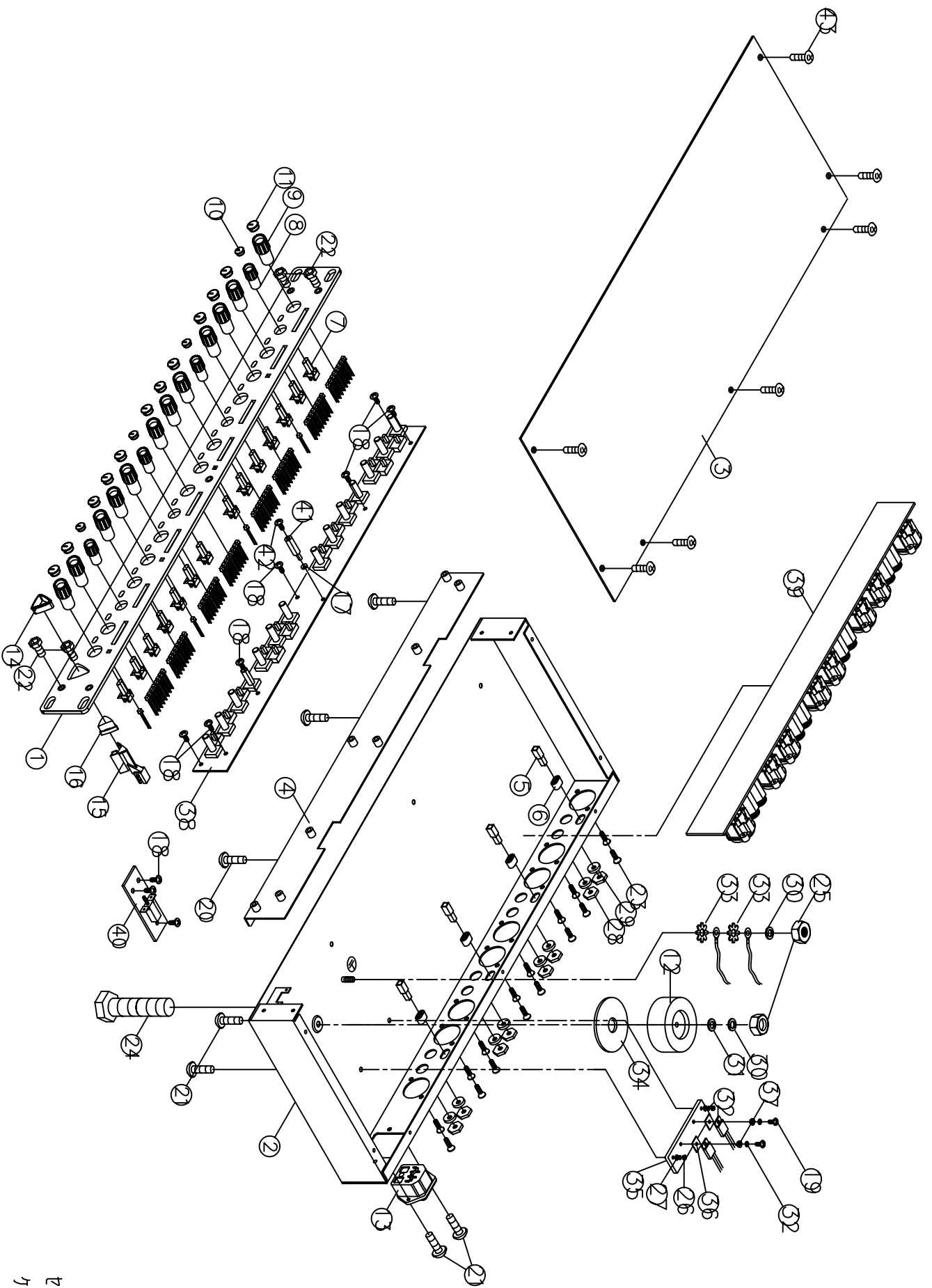

型号: ACL4
 规格: ACL4-00
 日期: 20041008

