

User's Manual

L-12

12-CHANNEL COMPACT INTEGRATED LIVE SOUND MIXER WITH DIGITAL EFFECTS



www.altoproaudio.com
Version 1.5 September 2005

— English —

SAFETY RELATED SYMBOLS



This symbol, wherever used, alerts you to the presence of un-insulated and dangerous voltages within the product enclosure. These are voltages that may be sufficient to constitute the risk of electric shock or death.



This symbol, wherever used, alerts you to important operating and maintenance instructions. Please read.



Protective Ground Terminal



AC mains (Alternating Current)



Hazardous Live Terminal

ON: Denotes the product is turned on.

OFF: Denotes the product is turned off.

WARNING

Describes precautions that should be observed to prevent the possibility of death or injury to the user.

CAUTION

Describes precautions that should be observed to prevent damage to the product.



Disposing of this product should not be placed in municipal waste and should be Separate collection.

WARNING

• Power Supply

Ensure that the mains source voltage (AC outlet) matches the voltage rating of the product. Failure to do so could result in damage to the product and possibly the user.

Unplug the product before electrical storms occur and when unused for long periods of time to reduce the risk of electric shock or fire.

• External Connection

Always use proper ready-made insulated mains cabling (power cord). Failure to do so could result in shock/death or fire. If in doubt, seek advice from a registered electrician.

• Do Not Remove Any Covers

Within the product are areas where high voltages may present. To reduce the risk of electric shock do not remove any covers unless the AC mains power cord is removed.

Covers should be removed by qualified service personnel only.

No user serviceable parts inside.

• Fuse

To prevent fire and damage to the product, use only the recommended fuse type as indicated in this manual. Do not short-circuit the fuse holder. Before replacing the fuse, make sure that the product is OFF and disconnected from the AC outlet.

• Protective Ground

Before turning the product ON, make sure that it is connected to Ground. This is to prevent the risk of electric shock.

Never cut internal or external Ground wires. Likewise, never remove Ground wiring from the Protective Ground Terminal.

• Operating Conditions

Always install in accordance with the manufacturer's instructions.

To avoid the risk of electric shock and damage, do not subject this product to any liquid/rain or moisture. Do not use this product when in close proximity to water.

Do not install this product near any direct heat source.

Do not block areas of ventilation. Failure to do so could result in fire.

Keep product away from naked flames.

IMPORTANT SAFETY INSTRUCTIONS

Read these instructions

Follow all instructions

Keep these instructions. Do not discard.

Heed all warnings.

Only use attachments/accessories specified by the manufacturer.

• Power Cord and Plug

Do not tamper with the power cord or plug. These are designed for your safety.

Do not remove Ground connections!

If the plug does not fit your AC outlet seek advice from a qualified electrician.

Protect the power cord and plug from any physical stress to avoid risk of electric shock.

Do not place heavy objects on the power cord. This could cause electric shock or fire.

• Cleaning

When required, either blow off dust from the product or use a dry cloth.

Do not use any solvents such as Benzol or Alcohol. For safety, keep product clean and free from dust.

• Servicing

Refer all servicing to qualified service personnel only.

Do not perform any servicing other than those instructions contained within the User's Manual.

PREFACE

Dear Customer:

Thank you for choosing the ▲LTO L-12 12-Channel Compact Integrated Live Sound Mixer with Digital Effects, which is the result of our ▲LTO AUDIO TEAM's endeavours.

For the ▲LTO AUDIO TEAM, music and audio is more than a profession, it is a passion and an obsession!

We have, in fact, been designing professional audio products for a number of years in cooperation with many of the world's major brands.

The ▲LTO line represents unparalleled analogue and digital products made by musicians, for musicians. With our design centres in Italy, the Netherlands, and the United Kingdom we provide you with world-class designs, while our software development teams continue to develop an impressive range of audio specific algorithms.

By purchasing our ▲LTO products you become the most important member of our ▲LTO AUDIO TEAM. We would like to share with you our passion for what we design and invite you to make suggestions, which will aid us in developing future products for you. We guarantee you our commitment for quality, continual research and development, and of course the best prices.

The ▲LTO L-12 is an extremely flexible, ultra-low noise 12-channel compact integrated live sound mixer with Digital Effects, configured with 4 mono and 4 stereo input channels, each channel is equipped with a variety of key features including a warm, natural sounding EQ, Peak LEDs and PAN/BAL control etc.. Besides, the L-12 is equipped with the miraculous 24 bit digital stereo effect processor with 256 presets. Seeing is believing, let's meet the ▲LTO L-12.

We would like to thank all the people who made the ▲LTO L-12 12-Channel Compact Integrated Live Sound Mixer with Digital Effects possible, especially to our designers and ▲LTO staff. It is their passion for music and professional audio that has made it possible for us to offer you, our most important team member, our continued support.

Thank you very much

▲LTO AUDIO TEAM

TABLE OF CONTENTS

1. INTRODUCTION.....	4
2. FEATURES.....	5
3. READY TO START?.....	6
4. CONTROL ELEMENTS.....	7
4.1 The mono MIC/LINE channels.....	8
4.2 INPUT LEVEL setting.....	8
4.3 Mono Channel INSERT.....	8
4.4 LOW-CUT FILTER.....	8
4.5 STEREO INPUTS.....	9
4.6 EQUALISER.....	9
4.7 AUX SEND.....	10
4.8 PAN.....	10
4.9 SG/PEAK.....	10
4.10 MUTE.....	10
4.11 FADER	11
4.12 ASSIGNMENT Control.....	11
4.13 MASTER SECTION	11
4.14 REAR PANEL DESCRIPTION	15
5. INSTALLATION AND CONNECTION.....	18
6. PRESET LIST.....	21
7. SYSTEM BLOCK DIAGRAMS.....	22
8. TECHNICAL SPECIFICATION.....	23
9. WARRANTY.....	25

1. INTRODUCTION

Thank you very much for expressing your confidence in ▲LTO products by purchasing ▲LTO L-12 12 Channel Compact Integrated Mixer with Digital Effects. The L-12 is professional compact mixer. You will get the smooth, accurate more natural and open sound from this apparatus, it is really ideal for large gigs, recording and fixed PA installations.

The L-12 12 Channel Compact Integrated Mixer with Digital Effects is packed with features that can not be found in other consoles of its size: 6 mono (these are provided with Ultra Low Noise microphone pre-amplifiers and Phantom Power at +48 Volt) and 4 stereo input channels, and each of them is provided with warm, natural EQ (channel1-4 are mono channels and equipped with 3 band MID sweep EQ; channel 5-12 are stereo channels and equipped with 4 band fixed frequency EQ); 24 bits digital stereo effect processor with 256 presets (16 presets × 16 variations); 4-AUX sends; separate level control on each channel; highly accurate 12-segment bar graph meters; 2-Track inputs assignable to main mix, control room / headphone outputs; subgroups output and small and exquisite modelling.

Your L-12 is very easy to operate but we advise you to go through each Section of this Manual carefully. In this way you will get the best out of your L-12.

2. FEATURES

The L-12 12 Channel Compact Integrated Mixer with Digital Effects is designed for professional appliance. It will provide the following features:

- 6 MIC input channels with gold plated XLRs and balanced LINE inputs
- 4 Stereo input channels with balanced TRS jacks
- Ultra-low noise discrete Mic Preamps with +48V Phantom Power
- Extremely high headroom offering more dynamic range
- 60mm high precision faders
- Each input channel with Mute, SOLO function, overload & signal present LEDs and low cut filters (except for stereo channel)
- SUB 1-2, SUB 3-4 and MAIN L-R signal assignment switch
- 4 AUX sends per channel: 2 PRE/POST faders switch-able for monitoring application effects & sound processor input; 2 POST faders for internal digital DFX or as external send
- 4-band fixed EQ on stereo line channels
- 3-band EQ with swept mid on microphone channels
- Channel inserts and direct outputs on each mono channel plus main mix insert for flexible connection of outboard equipment
- 24-bit DSP effect
- 256 effects (16 presets × 16 variations)
- Stereo 9-band graphic EQ
- BNC socket for connecting lamp
- Control room/phones matrix
- 2-TRACK IN assignable to main mix, control room/headphone outputs
- Highly accurate 12 segment output level meters

3. READY TO START?

- 3.1 Please check the AC Voltage available in your Country before connecting your L-12 to the AC socket.
- 3.2 Be sure that the main power switch is turned off before connecting the Mixer to the AC socket. Also, you should make sure that all Input and Output Controls are turned down. This will avoid damages to your speakers and avoid excessive noise.
- 3.3 Before turning on the L-12 you shall connect it to a power amplifier and turn-on the mixer BEFORE the power amplifier. Once you have finished your working session you shall turn the mixer off AFTER the power amplifier.
- 3.4 Before disconnecting the L-12 always turn-off the Power switch.
- 3.5 Do not use solvents to clean your L-12. A dry and clean cloth will be OK.

4. CONTROL ELEMENTS

MIC 1 	MIC 2 	MIC 3 	MIC 4 	MIC 5 	MIC 6 	2 TRACK IN/OUT L R TAPE IN TAPE OUT	LAMP 12V 0.5A					
LINE IN 1 BAL/UNBAL INSERT	LINE IN 2 BAL/UNBAL INSERT	LINE IN 3 BAL/UNBAL INSERT	LINE IN 4 BAL/UNBAL INSERT	LINE IN 5 LEFT (MONO) BAL/UNBAL RIGHT	LINE IN 6 RIGHT			LINE IN 7 LEFT (MONO) BAL/UNBAL RIGHT	LINE IN 8 RIGHT	LINE IN 9 LEFT (MONO) RIGHT	LINE IN 10 RIGHT	LINE IN 11 LEFT (MONO) RIGHT

ALTO L-12
12 CHANNEL COMPACT INTEGRATED LIVE SOUND MIXER
WITH DIGITAL EFFECTS

24BITS DIGITAL STEREO EFFECTS PROCESSOR

1. VOCAL 1
9. SPRING REVERB
2. VOCAL 2
10. MONO DELAY
3. LARGE HALL
11. STEREO DELAY
4. SMALL HALL
12. FLANGER
5. LARGE ROOM
13. CHORUS
6. SMALL ROOM
14. REVERB + DELAY
7. PLATE
15. REVERB + FLANGER
8. TAPE REVERB
16. REVERB + CHORUS

TRIM 1 0dB 60dB MIC +15dB 45dB LINE LOW CUT 75Hz 18dB/Oct	TRIM 2 0dB 60dB MIC +15dB 45dB LINE LOW CUT 75Hz 18dB/Oct	TRIM 3 0dB 60dB MIC +15dB 45dB LINE LOW CUT 75Hz 18dB/Oct	TRIM 4 0dB 60dB MIC +15dB 45dB LINE LOW CUT 75Hz 18dB/Oct	MIC GAIN 5 0dB 60dB MIC	MIC GAIN 6 0dB 60dB M C	LINE GAIN 9/10 20 +20	LINE GAIN 11/12 20 +20	EFFECTS OUT AUX1 AUX2 PRESETS VARIATIONS PWR DFX2(INT) RETURN EFFECTS TO MONITOR DSP MUTE PEAK PHANTOM
EQ HI 12kHz MID 800 FREQ 100Hz-8kHz LOW 80Hz	EQ HI 12kHz MID 800 FREQ 100Hz-8kHz LOW 80Hz	EQ HI 12kHz MID 800 FREQ 100Hz-8kHz LOW 80Hz	EQ HI 12kHz MID 800 FREQ 100Hz-8kHz LOW 80Hz	EQ HI 12kHz MID 3kHz M D LOW 500Hz LOW 80Hz	EQ HI 12kHz MID 3kHz M D LOW 500Hz LOW 80Hz	EQ HI 12kHz MID 3kHz M D LOW 500Hz LOW 80Hz	EQ HI 12kHz MID 3kHz M D LOW 500Hz LOW 80Hz	
AUX 1 2 3 4	AUX 1 2 3 4	AUX 1 2 3 4	AUX 1 2 3 4	AUX 1 2 3 4	AUX 1 2 3 4	AUX 1 2 3 4	AUX 1 2 3 4	AUX SENDS STEREO AUX RETURNS CTRL ROOM SOURCE 1 TO AUX SEND1 2 TO AUX SEND2 3 MAIN M X 4 DFX2 RETURN SUB 1/2 SUB 3/4 MAIN M X LEVEL SET CLIP 10 7 4 2 0 2TK TO MIX SOLO ACTIVE SOLO MODE L R PFL AFL OUTPUT LEVEL
PAN LEFT RIGHT	PAN LEFT RIGHT	PAN LEFT RIGHT	PAN LEFT RIGHT	BAL LEFT RIGHT	BAL LEFT RIGHT	BAL LEFT RIGHT	BAL LEFT RIGHT	
SG PEAK 10 6 0 -6 -10 -15 -20 -25 -30 -40 -50 -60 -70 -80 -90 -100 MUTE	SG PEAK 10 6 0 -6 -10 -15 -20 -25 -30 -40 -50 -60 -70 -80 -90 -100 MUTE	SG PEAK 10 6 0 -6 -10 -15 -20 -25 -30 -40 -50 -60 -70 -80 -90 -100 MUTE	SG PEAK 10 6 0 -6 -10 -15 -20 -25 -30 -40 -50 -60 -70 -80 -90 -100 MUTE	SG PEAK 10 6 0 -6 -10 -15 -20 -25 -30 -40 -50 -60 -70 -80 -90 -100 MUTE	SG PEAK 10 6 0 -6 -10 -15 -20 -25 -30 -40 -50 -60 -70 -80 -90 -100 MUTE	SG PEAK 10 6 0 -6 -10 -15 -20 -25 -30 -40 -50 -60 -70 -80 -90 -100 MUTE	SG PEAK 10 6 0 -6 -10 -15 -20 -25 -30 -40 -50 -60 -70 -80 -90 -100 MUTE	SUB 1 SUB 2 SUB 3 SUB 4 SUBGROUPS MAIN MIX LEVEL

4. CONTROL ELEMENTS

4.1 The mono MIC/LINE channels 1

These are Channel 1 through Channel 4. You can connect balanced, low impedance microphones to the XLR socket. On the 1/4" phone jack you can connect either a microphone or a line level instrument. You shall never connect an unbalanced microphone to the XLR socket if you do not want to damage both the Microphone and the Mixer.

48 Volt phantom power 4

It is available only to the XLR Mic sockets. Never plug in a microphone when phantom power is already on. Before turning phantom power on, make sure that all faders are all the way down. In this way you will protect your Stage Monitors and Main Loudspeakers.

4.2 INPUT LEVEL setting 2

This Control is provided with 2 different indication rings: One is for the Microphone and the other for the Line levels. When you use a microphone you shall read the OUTSIDE ring (0-60 dB), When you use a Line level instrument you shall read the INSIDE ring (+15~-45 dB). For optimum operation you shall set this control in a way that the peak LED will blink also occasionally in order to avoid distortion on the input channel.

4.3 Mono Channel INSERT 3

Insert points are provided for the Mono Mic Channels. When you insert a TRS jack in the insert socket, the signal will be taken out after the Input Gain Control (Trim), sent to an external processor such as a compressor-limiter, and returned into the channel strip immediately before the EQ section. Of course, the jacks used must be stereo (Tip Send/Ring Return).

4.4 LOW-CUT FILTER 5

By pressing this button you will activate a 75 Hz low frequency filter with a slope of 18 dB per octave. You can use this function to reduce hum and stage rumble when using microphones.

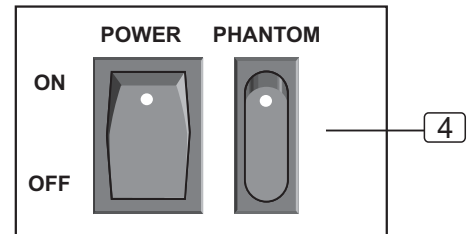
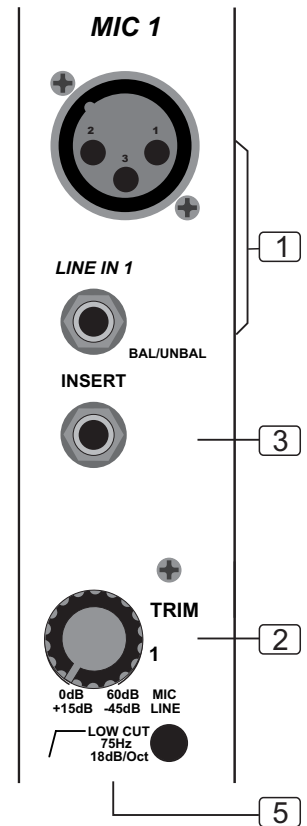

4.5 STEREO INPUTS

6

These are Channel 5 through 12. They are organised in stereo pair (5/6 and 7/8 pairs also feature XLR Mic inputs 5 and 6) and they are provided with 1/4" TRS phone sockets.

If you connect only the left jack, the input will operate in mono mode.

Your L-12 also provides the practical input level setting: MIC GAIN (the adjustable range is from 0dB to 60dB) for MIC 5/MIC 6 and LINE GAIN (the adjustable range is from -20dB to +20dB) for LINE IN 9/10 and LINE IN 11/12.

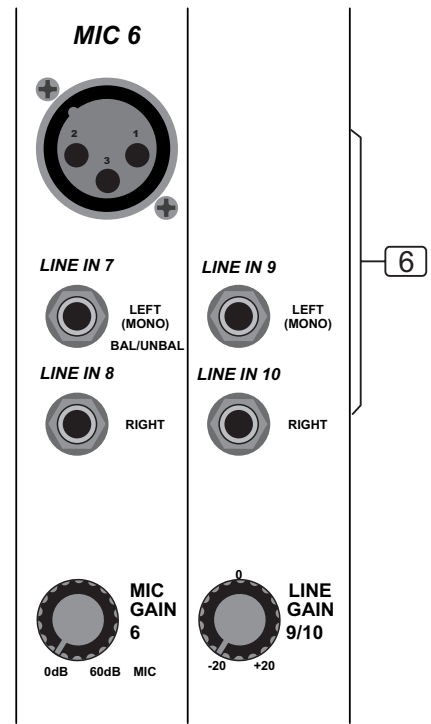

4.6 EQUALISER

The mono input channels (channel 1- channel 4) are equipped with 3 band MID sweep EQ: HI band, MID band and LOW band; And the stereo channels (channel 5-channel 12) are equipped with 4 band fixed frequency equalization: HI band, HI-MID band, MID-LOW band and LOW band. All bands provide up to 15dB of boost or cut.

4.6.1 HI

7

This is the Treble control. You can use it to get rid of high frequency noises or to boost the sound of cymbals or the high harmonics of the human voice. The gain range goes from -15dB to +15dB with a center frequency of 12 kHz.

4.6.2 MID

8

This is the Midrange control. It provides 15dB of boost or cut, flat at the center detent and the FREQ knob sets the center frequency, the adjustable range is from 100Hz to 8kHz. It can affect most fundamental frequencies of all musical instruments and human voice. An attentive use of this control will give you a very wide panorama of sound effects.

4.6.3 HI-MID

9

This control gives you up to 15dB boost or cut at 3kHz. It is useful for controlling voice. It can accurately polish your performance via adjusting this knob.

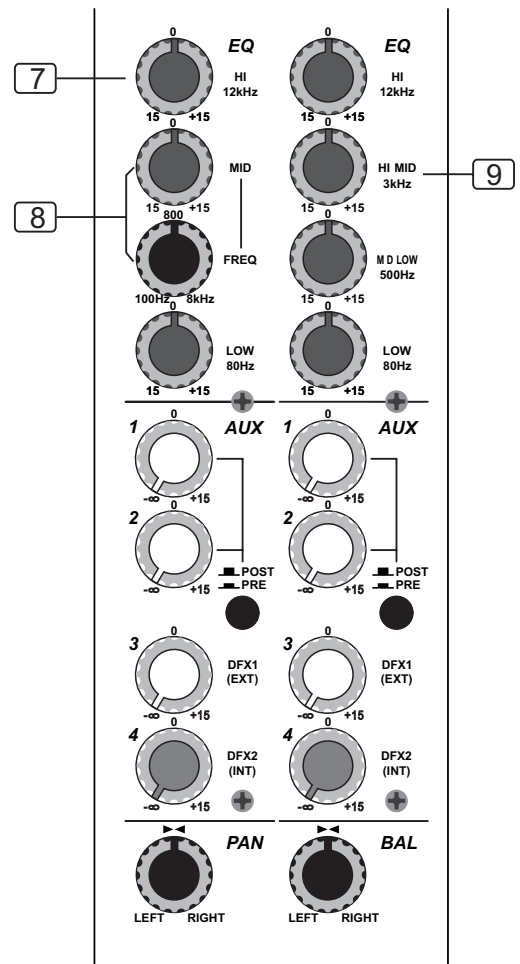

4.6.4 MID-LOW 10

This control gives you up to 15dB boost or cut at 500Hz.

4.6.5 LOW 11

This is the Bass control. Boost male voice or kickdrum and bass guitar. Your system will sound much bigger than what it is. The gain range goes from -15dB to +15dB and the center frequency is 80 Hz.

4.7 AUX SENDS Level Control 12

These four controls are used to adjust the level of the signal sent to AUX buses, and their adjustable range goes from $-\infty$ to +15dB.

AUX1 and AUX2 can be switched to PRE/POST-FADER via the PRE/POST button, so, generally, they can be used for monitor application and effects & sound processors input.

AUX3 and AUX4 are configured as POST-Faders.

In this typical compact unit, excluding sending out directly to the external effect or processor equipment, AUX SEND 4 can also be assigned to the internal onboard effect module.

4.8 PAN 13

This is the PANORAMA control, or balance control. Rotate this control to determine the amount of channel signal sent to left/right of MAIN MIX when Main L-R push-button is pressed. Keep this control in center position and your signal will be positioned in the middle of stage. Turn this control fully counterclockwise, the signal will be present only on the left of MAIN MIX and vice-versa.

Besides, the PAN or BAL control has the same affection to SUB 1-2 and SUB 3-4 if the SUB 1-2 or SUB 3-4 push-button is pressed. Of course a wide number of intermediate positions is available.

4.9 SG/PEAK 14

Inside your L-12 the audio signal is monitored in several different stages and then sent to the SG/PEAK LED. When the LED shows green, it indicates that there present signal on corresponding channel; When the LED turns into red, it warns you that you are reaching signal saturation and possible distortion, then you should reduce the input level for avoiding distortion.

4.9 MUTE 15

Each channel is equipped with the MUTE switch. Pressing this switch is equal to turning the fader down, which can mute the corresponding channel output except for channel INSERT send and SOLO (in PFL mode). And the MUTE LED will illuminate.

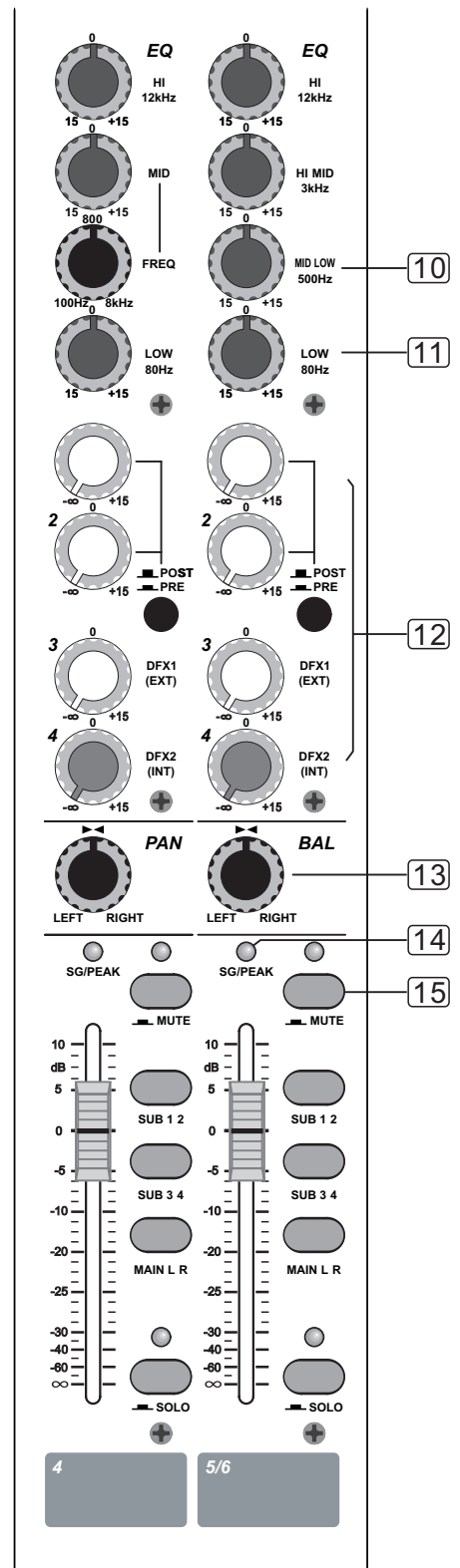

4.10 FADER 16

This Fader will adjust the overall level of this channel and set the amount of signal sent to the Main output or the corresponding subgroup output.

4.11 ASSIGNMENT Control 17

Each channel provides four push-buttons: SUB1-2, SUB3-4, MAIN L-R and SOLO.

Pressing the SOLO button, the corresponding SOLO LED will illuminate and the SOLO signal will replace other signals sent to the headphone/CONTROL ROOM and meters.

Usually use the SOLO function in live work to preview channels before they are let into the mix. It is useful to set an instrument's input level and EQ, and you can also solo any channel that you want to. The SOLO switch never affects any mix other than the CONTROL ROOM.

The other three buttons can be considered as signal assignment switches. Pressing the SUB 1-2 will assign the channel signal to Subgroup1/2, you can depend on the PAN switch to adjust the amount of channel signal sent to the SUB1 versus SUB2, when turns the PAN to completely left, then the signal can be only controlled by Subgroup1 and vice-versa.

In the same way, pressing the SUB 3-4 or MAIN L/R will assign the channel signal to Subgroup3/4 or MAIN MIX L/R, and will also be affected by PAN.

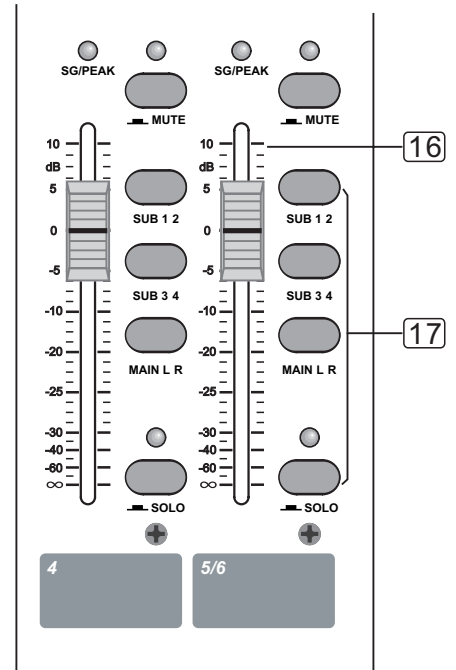

4.12 MASTER SECTION

- Control Room Source 18

You can choose to monitor any combination of MAIN MIX, SUB1-2, SUB 3-4 and 2TK IN via these MATRIX switches. Engaging these switches, these stereo signals will be delivered to the PHONES, CONTROL ROOM and METERS display.

Note: When any SOLO switch was engaged, the SOLO signal will replace other signals, and also be sent to the CONTROL ROOM, PHONES and METERS.

- PHONES/CTRL ROOM 19

Rotate these knobs to adjust the stereo level of CTRL ROOM and PHONES outputs separately, which can be varied from $-\infty$ to MAX.

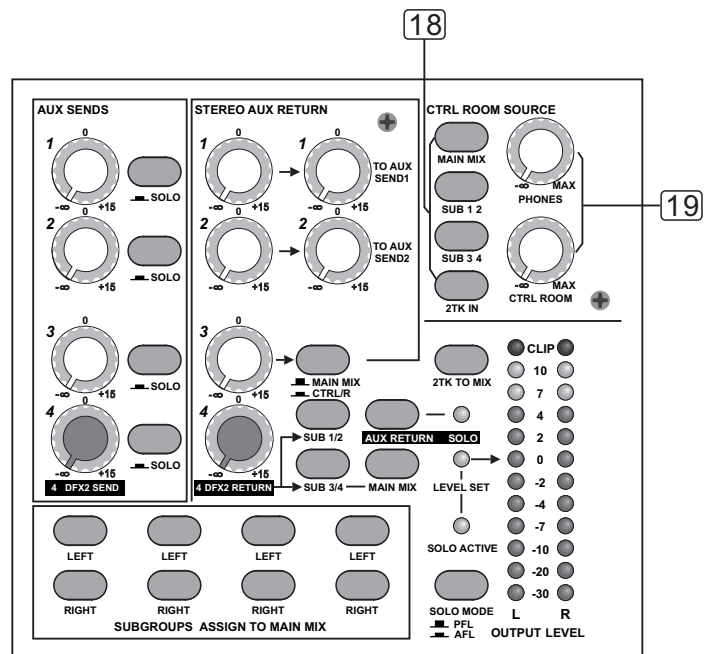

- Master AUX SENDS 20

The four switches are used to determine the master AUX SEND levels, which can be varied from $-\infty$ to +15dB.

When the external effect unit connected to mixer has no input gain control, you can get a further +15dB gain available from these AUX SEND outputs.

As to the AUX4, it can also provide the lovable level adjustment for the internal effect signal.

- SOLO 21

The function of these SOLO buttons are the same as the channel SOLO button, they can also be affected by SOLO MODE switch.

Press the SOLO button, the corresponding AUX send will be routed to CTRL ROOM/ PHONES outputs and METERS display.

- Master STEREO AUX RETURNS 22

These four controls set the level of effects that received from the stereo AUX RETURN connectors, which can be varied from $-\infty$ to +15dB. They are used to provide the further gain for low level effects.

- TO AUX SEND1/2 23

The both rotary knobs assign the AUX RETURN signals to their respective AUX SEND outputs: The TO AUX SEND1 assign the signal from AUX RETURN1 to AUX SEND1 bus, and TO AUX SEND2 assign the signal from AUX RETURN2 to AUX SEND2 bus.

The adjustable range goes from $-\infty$ to +15dB.

- MAIN MIX - CTRL/R 24

AUX RETURN3 is equipped with the MAIN MIX / CTRL/R button. Release the button to send the stereo signal from AUX RETURN3 to MAIN MIX buses; Engage the button, then the stereo signal will be sent to CTRL/R output.

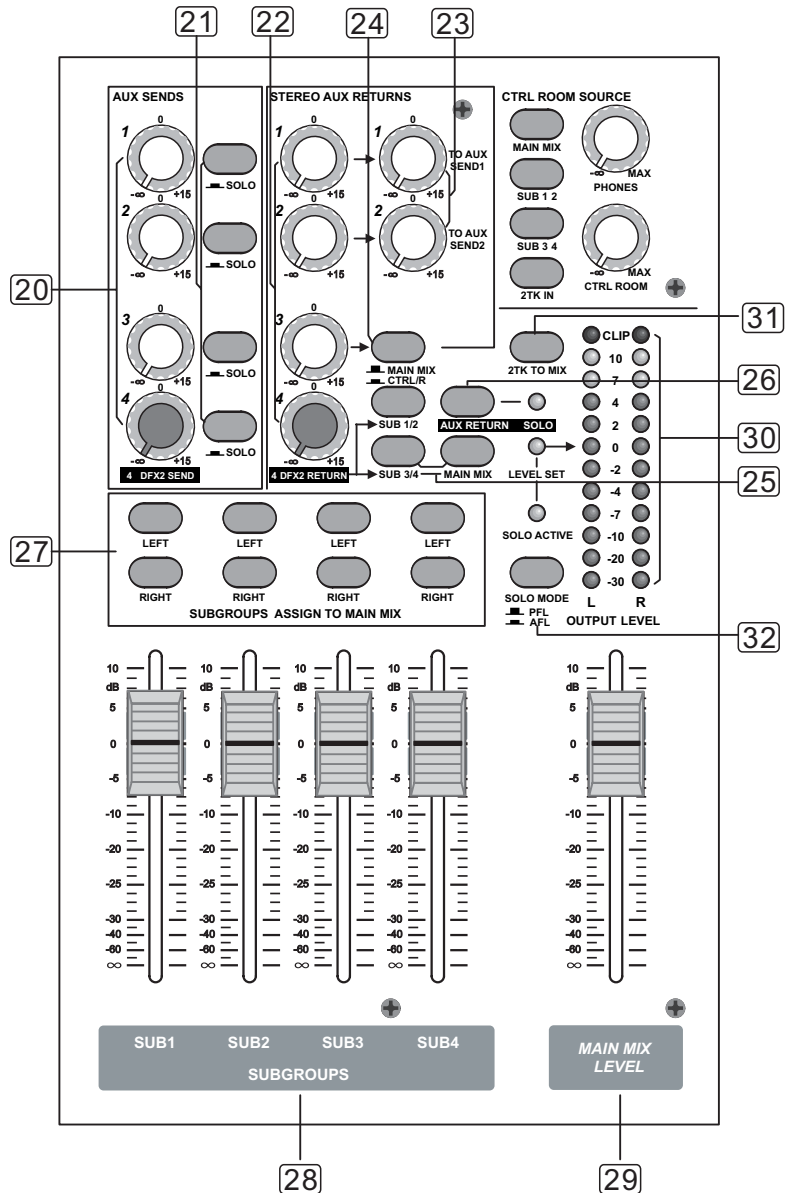

- SUB1-2/3-4/MAIN MIX 25

These three buttons are configured for AUX RETURN4, they can be regarded as the signal assignment switch. When engaging the SUB1-2, the stereo signal from AUX RETURN4 will be assigned to Submix1/2; in the same way, SUB3-4 for Submix3/4, MAIN MIX for MAIN MIX buses.

- AUX RETURN SOLO 26

The function of AUX RETURN SOLO is like the channel SOLO button. Engaging it sends the signal from AUX RETURN (1-4) to the CTRL OUT, PHONES outputs and METERS display. It can also be affected by SOLO mode button, and the LED next the button will illuminate.

- SUBGROUPS ASSIGN TO MAIN MIX 27

Through these switches, you can operate the subgroup faders as a master control for assigning the subgroups to MAIN MIX. Engage the LEFT switch to send the corresponding subgroup signal to MAIN MIX L, and the RIGHT switch for MAIN MIX R. When engaging the both switches, the signal will be sent to L/R of MAIN MIX.

- SUBGROUPS 28

These faders are used to control the levels of signals sent to the SUBGROUPS OUT, the adjustable range is from $-\infty$ to +10dB. Any channel that is assigned to the subgroups, not muted and not turned down will be assigned to the SUB OUTS.

- MAIN MIX LEVEL 29

This fader sets the amount of signal sent either to the Main Mix Output sockets or to the Tape Output.

- LED METER 30

The stereo 12 segments LED Meter will indicate the signal level sent to CTRL ROOM and PHONE outputs.

- 2TK TO MIX 31

Engaging this switch allows you to combine the 2 TRACK Output with the MAIN MIX. In other words, feeds the 2TRACK IN signals into MAIN L/R output.

- SOLO MODE 32

This button provides two modes: up for PFL (Pre-Fader-Listen) mode, down for AFL (After-Fader-Listen) mode. Engage the button, the soloed signal will output following the LEVEL control, otherwise, release the button will output the soloed signal before the level control

Please note that the SOLO function can never affect the mix at main recording output, and also can't be affected by channel's MUTE switch.

- 24 BIT DIGITAL EFFECTS

PRESETS 33

Adjust this knob to select the right effect you wish to perform. There are total 16 options for you: several kinds of reverb, mono and stereo delay, effects with modulation, and versatile two-effect combination.

VARIATIONS 34

Since you have selected the preferable effect, the next step, please go with the fine consideration, there are also total 16 variations for each preset, and each variation may be managed by several different factors.

MUTE SWITCH 35

This switch is used to activate/deactivate the effect facility. Sometimes, you can also use the DFX FOOT SWITCH (on rear panel) for convenient operation.

PEAK LED 36

This LED lights up when the input signal is too strong. In case of the digital effect module being muted, this LED also lights up.

EFFECTS OUT 37

Rotate this knob to adjust the level of effect signal that intercepted from internal DSP processor and directly sent to DFX OUT, which can be varied from $-\infty$ to +15dB.

DFX2(INT) RETURN EFFECTS TO MONITOR 38

These AUX1 and AUX2 controls are used to set the signal level from AUX RETURN4, which signal will be sent to AUX SEND1 and AUX SEND2. The adjustable range can be varied from $-\infty$ to +15dB.

POWER LED 39

The LED indicates when the Power is on in your L-12.

PHANTOM LED 40

This LED indicates when the Phantom Power is switched on.

EQ switch 41

Engage this button to add the stereo graphic EQ into the MAIN MIX output circuit. It can be used to modify the frequency "contour" of a sound. If you release the button free, the stereo graphic EQ will be bypassed.

STEREO GRAPHIC EQ 42

Each one of these faders will boost or attenuate (+/-15dB) the selected frequency at a preset bandwidth. When all the sliders are in the centre position, the output of the equalizer is flat response.

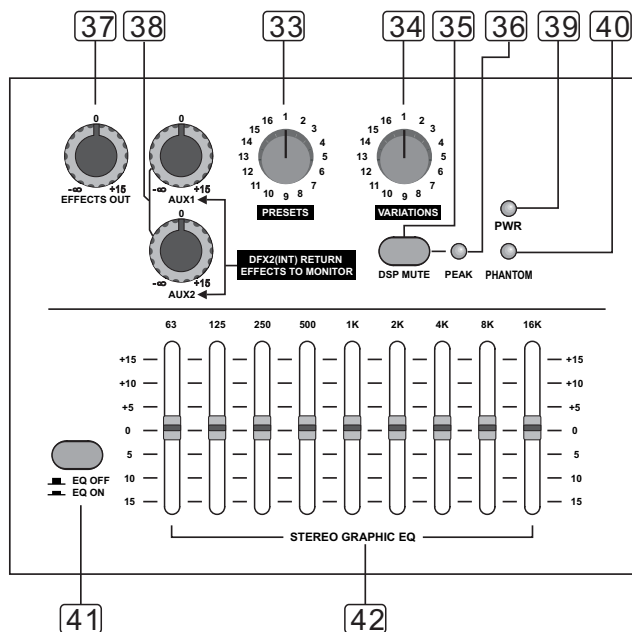

- 2-TRACK IN/OUT 43

TAPE IN

Use the Tape input if you wish to listen to your Mix from a Taper Recorder or DAT. You can assign the signal coming from the Taper Recorder either to a pair of studio monitor using the Control Room assignment on the front panel or you can also send the signal directly to the Main Mix.

TAPE OUT

These RCA jacks will route the main mix into a tape recorder.

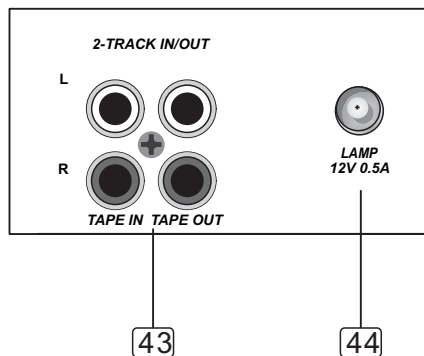

- LAMP 44

This lovable LAMP is very convenient for your operation, it is located in the top right corner of the front panel, and provides the 12V socket that can drive any standard BNC-type lamp. Please use the customized gooseneck lamps, the GL-SQ and GL-RO are both options.

- PHONES 45

These sockets will send out the monitor signal to a pair of headphones.

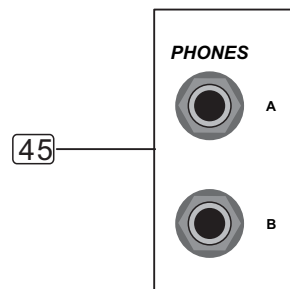

4.12 REAR PANEL DESCRIPTION

- POWER ON/OFF switch 46

This switch is used to turn the Main Power ON and OFF.

- PHANTOM ON/OFF switch 4

This switch will apply +48 Volt Phantom Power only to the 6 XLR microphone inputs. Never connect microphones when the Phantom Power is on already.

- AC INLET WITH FUSE HOLDER 47

Use it to connect your L-12 to the Main AC with the supplied AC cord. Please check the Voltage available in your Country and how the Voltage for your L-12 is configured before attempting to connect your L-12 to the Main AC.

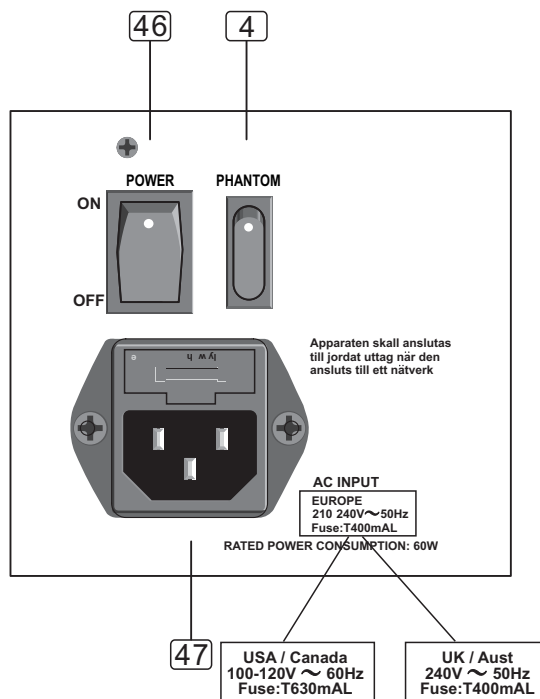

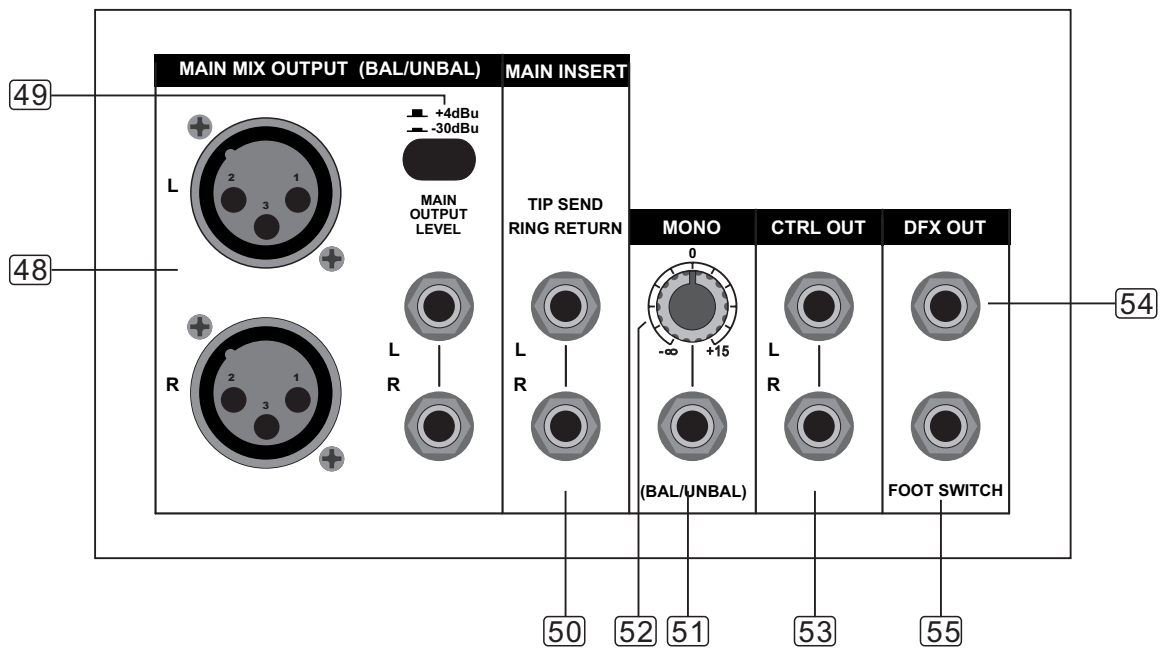

- MAIN MIX OUTPUT 48

This stereo output is supplied with both the XLR and 1/4" phone sockets and it is controlled by the Main Mix Level.

- MAIN OUTPUT LEVEL 49

This button sets the main mix output level to match the input of the device that you are ready to connect. Engage this button to reduce the output level from MAIN MIX OUTPUT by 30dBu, it used to match the semipro -30dBu device, on the contrary, to match the professional +4dBu device.

- MAIN INSERT 50

These two 1/4" phone sockets are stereo insert points and used to connect processors such as compressors, equalisers etc.. When insert a external processor into the jack, the Main stereo signal will be taken out after the EQ and returned into the MAIN MIX output before the MAIN MIX fader.

- MONO OUTPUT 51

This 1/4" phone socket is balanced/unbalanced mono mix output connector, it can be regarded as a sum output of the left and right of MAIN MIX.

- MONO LEVEL 52

This knob sets the level of mono mix output signal, which can be varied from $-\infty$ to +15dB.

- CTRL OUT 53

These 1/4" phone sockets will be used to send the control room signal to the Studio Monitor speakers or a second set of PA.

- DFX OUT 54

This 1/4" phone socket is used to output the effect signal that comes from internal DSP module and the signal can be controlled in level by EFFECTS OUT control.

- FOOTSWITCH 55

This 1/4" phone socket can be used to connect an external footswitch to turn on/off the onboard effect module.

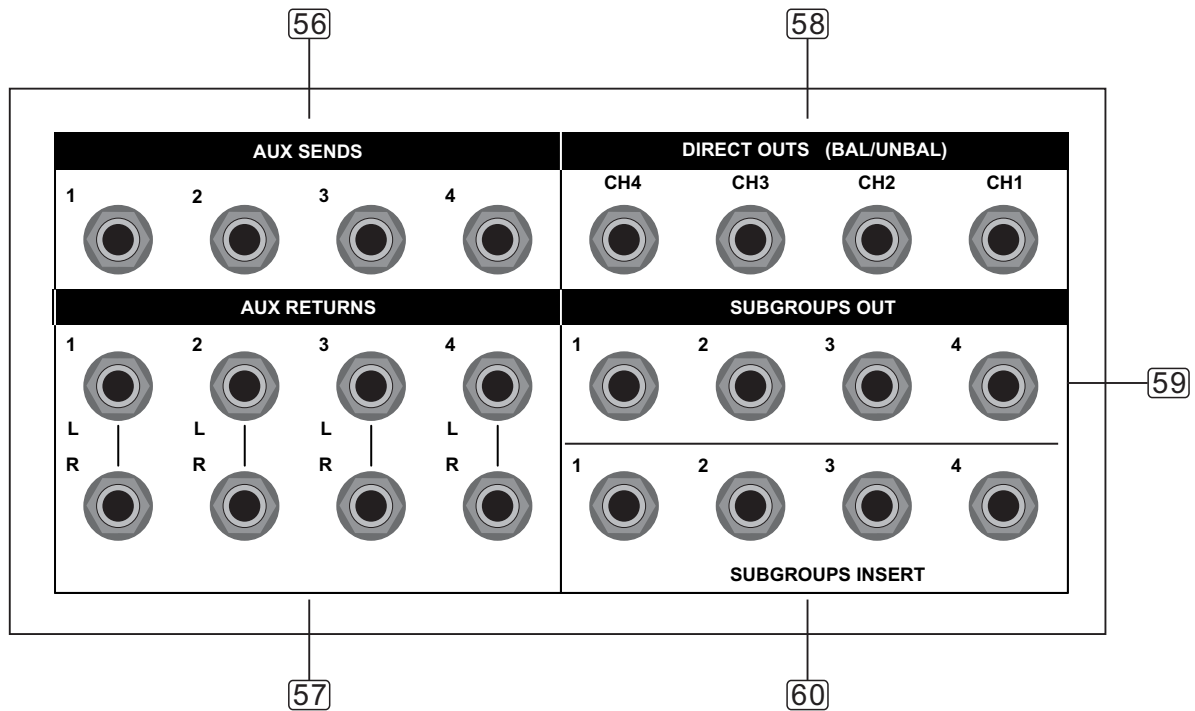

- AUX SENDS

(56)

These 1/4" phone sockets are used to send out the signal from the AUX Bus to external devices such as effects.

- AUX RETURNS

(57)

Use these stereo 1/4" phone sockets to return the sound of an effect unit to the Main Mix. You can also use them as an extra auxiliary input.

- DIRECT OUTS

(58)

Each MONO MIC/LINE channel (CH1-CH4) is equipped the 1/4" phone socket for direct output. These jacks are used to send the signal from the channel path to external device for recording function etc..

- SUBGROUPS OUT

(59)

These 1/4" phone sockets are used to connect the inputs of deck or secondary in a complicated PA live sound system. You will find it is the best tool when you operate the SUBGROUPS OUT.

- SUBGROUPS INSERT

(60)

These 1/4" phone sockets are insert points. They are used to connect processors such as compressor, limiter, EQ etc.. When insert external processor into these jacks, the subgroup stereo signal will be taken out, then returned to before subgroups fader. Of course, these jacks used must be stereo (Tip Send/Ring Return).

5. INSTALLATION AND CONNECTION

Ok, you have got to this point and you are now in the position to successfully operate your L-12. However, we advise you to read carefully the following section to be the real Master of your own Mix. Not paying attention enough to the input signal level, to the routing of the signal and the assignment of the signal will result in unwanted distortion, a corrupted signal or no sound at all. So you should follow this procedure for every single channel:

- Turn down all Input and Output Gain Controls.
- Connect phantom powered microphones before switching on the +48Volt Phantom Power switch.
- If you have a power amplifier connected to your L-12 set the Level of the amplifier at no more than 75%.
- Now, set the CONTROL ROOM/PHONES level at no more than 50%. In this way you will be able to hear later what you are doing connecting a pair of headphones or a pair of powered studio monitor speakers.
- Position EQ controls on middle position.
- Position panoramic (PAN) control on center position.
- With a headphone or studio monitor speakers connected apply a Line Level input signal so that the PEAK LED does not light up.
- At this point increase the input gain so that the PEAK LED will blink occasionally. In this way you will maintain good headroom and ideal dynamic range.
- Now connect a microphone and ask the singer to sing loud into the microphone. Turn slowly the Gain Control clockwise and have the PEAK LED blink only occasionally.
- Now repeat the same sequence for all input channels. The Main LED Meter could move up into the red section. In this case you can adjust the overall output level through the MAIN MIX control.

5.1 SOME FINAL TIPS ON WIRING CONFIGURATION

You can connect unbalanced equipment to balanced inputs and outputs. Simply follow these schematics.

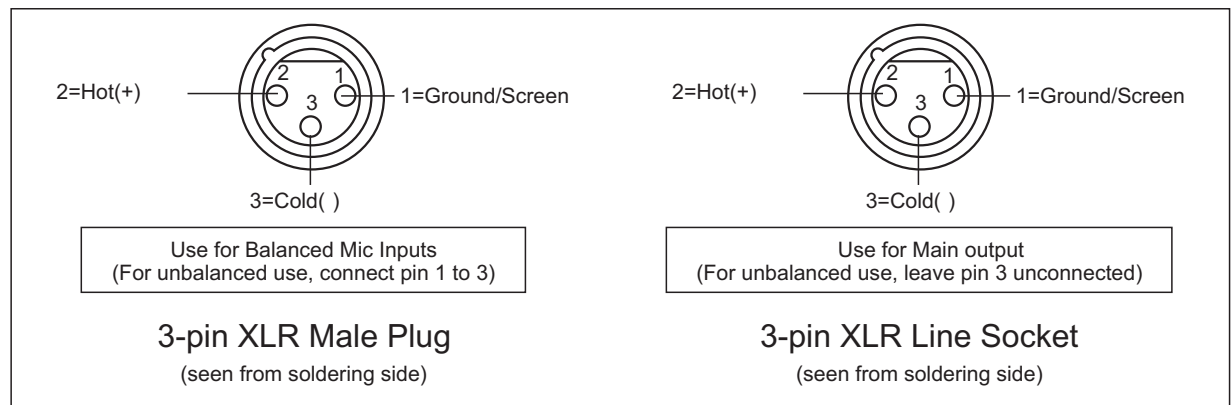
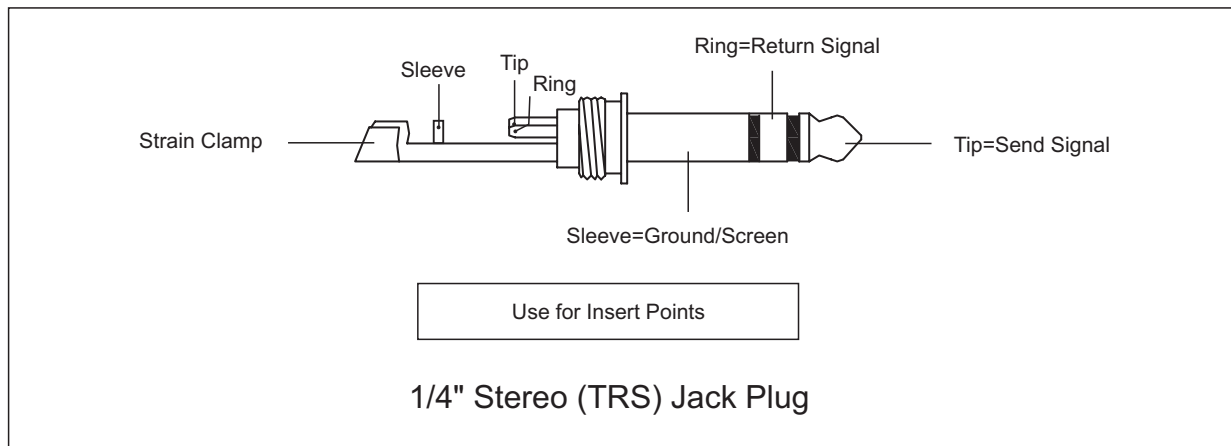
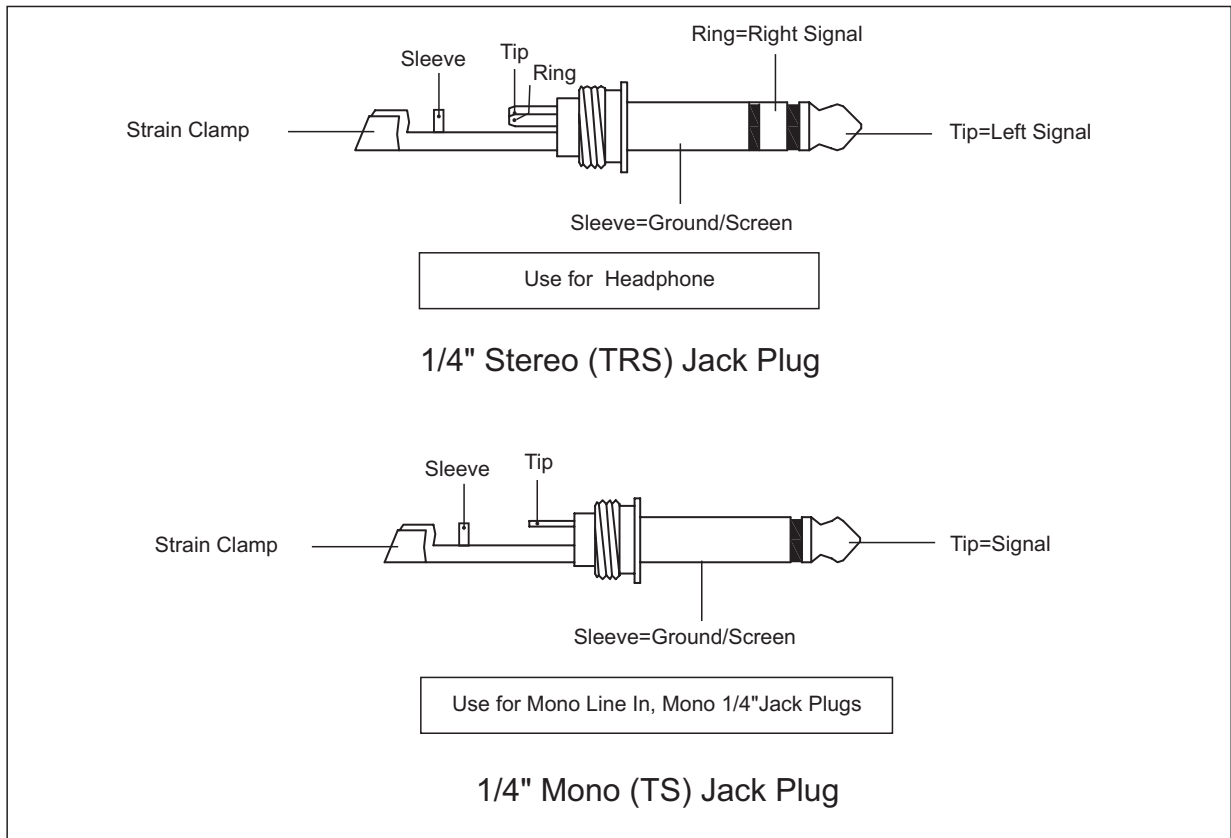

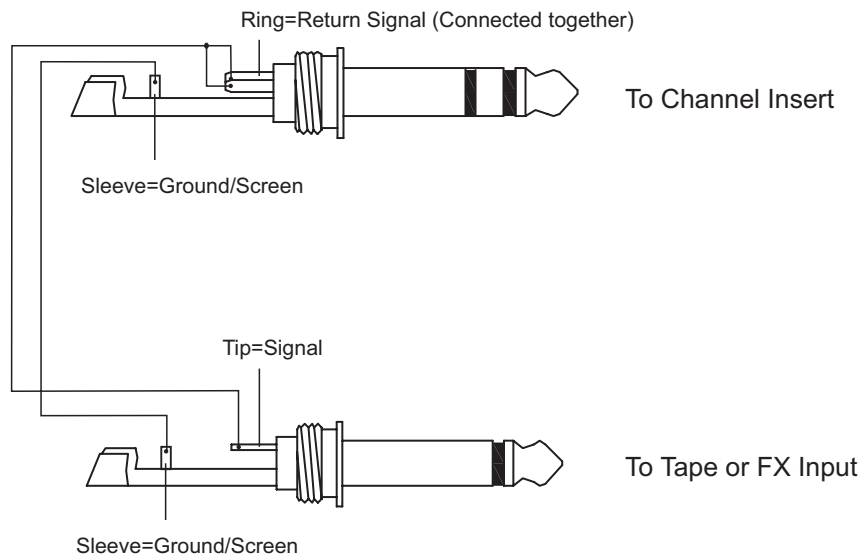

'Tapped' Connection Direct Output Lead

(Enables the Insert to be used as a Direct Output while maintaining the channel signal flow)

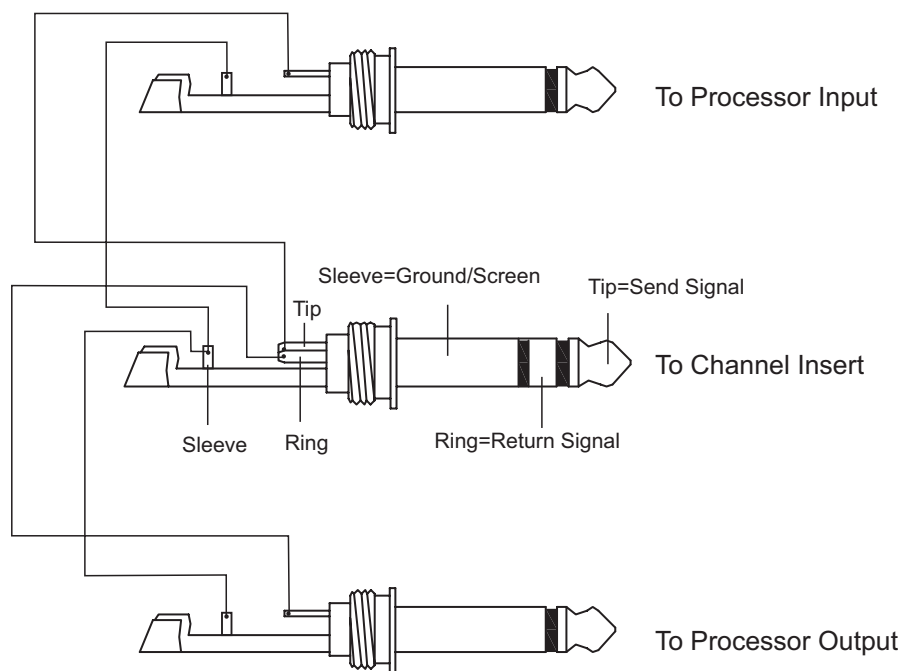

Y-Stereo lead for insert Connection

(To be used when the processor does not employ a single jack connection for the In/Out Connections)

6. PRESET LIST

No.	Preset	Description	Controllable parameter	
			Parameter	Variable range
1	VOCAL 1	Simulate a room with small delay time.	Decay time Pre-delay	0.8~1.1s 0~79ms
2	VOCAL 2	Simulate a small space with slight decay time.	Decay time Pre-delay	0.8~2.5s 0~79ms
3	LARGE HALL	Simulate a large acoustic space of the sound.	Decay time Pre-delay	3.6~5.4s 23~55ms
4	SMALL HALL	Simulate a small acoustic space of the sound.	Decay time Pre-delay	1.0~2.9s 20~45ms
5	LARGE ROOM	Simulate a studio room with many early reflections.	Decay time Pre-delay	2.9~4.5s 23~55ms
6	SMALL ROOM	Simulate a bright studio room.	Decay time Pre-delay	0.7~2.1s 20~45ms
7	PLATE	Simulate the transducers sound like classic bright vocal plate.	Decay time Pre-delay	0.6~6.1s 10ms
8	TAPE REVERB	Simulate a record head and multiple playback heads at intervals along the tape.	Decay time Pre-delay	1.3~5.4s 0~84ms
9	SPRING REVERB	Simulate the analog transducers' springs lightly stretched sound.	Decay time Pre-delay	1.3~5.4s 0~35ms
10	MONO DELAY	Reproduce the sound input on the output after a lapse of time.	Period	60~650ms
11	STEREO DELAY	Recreate the input sound on the stereo output with different time.	Period Feedback	210~400ms 37~73%
12	FLANGER	Simulate to play with another person carrying out same the notes on the same instrument	Rate	0.16~2.79Hz
13	CHORUS	Recreate the illusion of more than one instrument from a single instrument sound	Rate	0.5~5Hz
14	REV.+DELAY	Delay with room effect	Delay period Rev. decay time	211~375ms 1.0~2.9s
15	REV.+FLANGER	Stereo chorus and large room reverb	Flanger Rate Rev. decay time	0.16~2.52Hz 1.5~2.9s
16	REV.+CHORUS	Simulate the sound effect achieved by rotating horn speakers and a bass cylinder	Chorus rate Rev. decay time	0.5~4.74Hz 1.5~2.9s

7. BLOCK DIAGRAMS

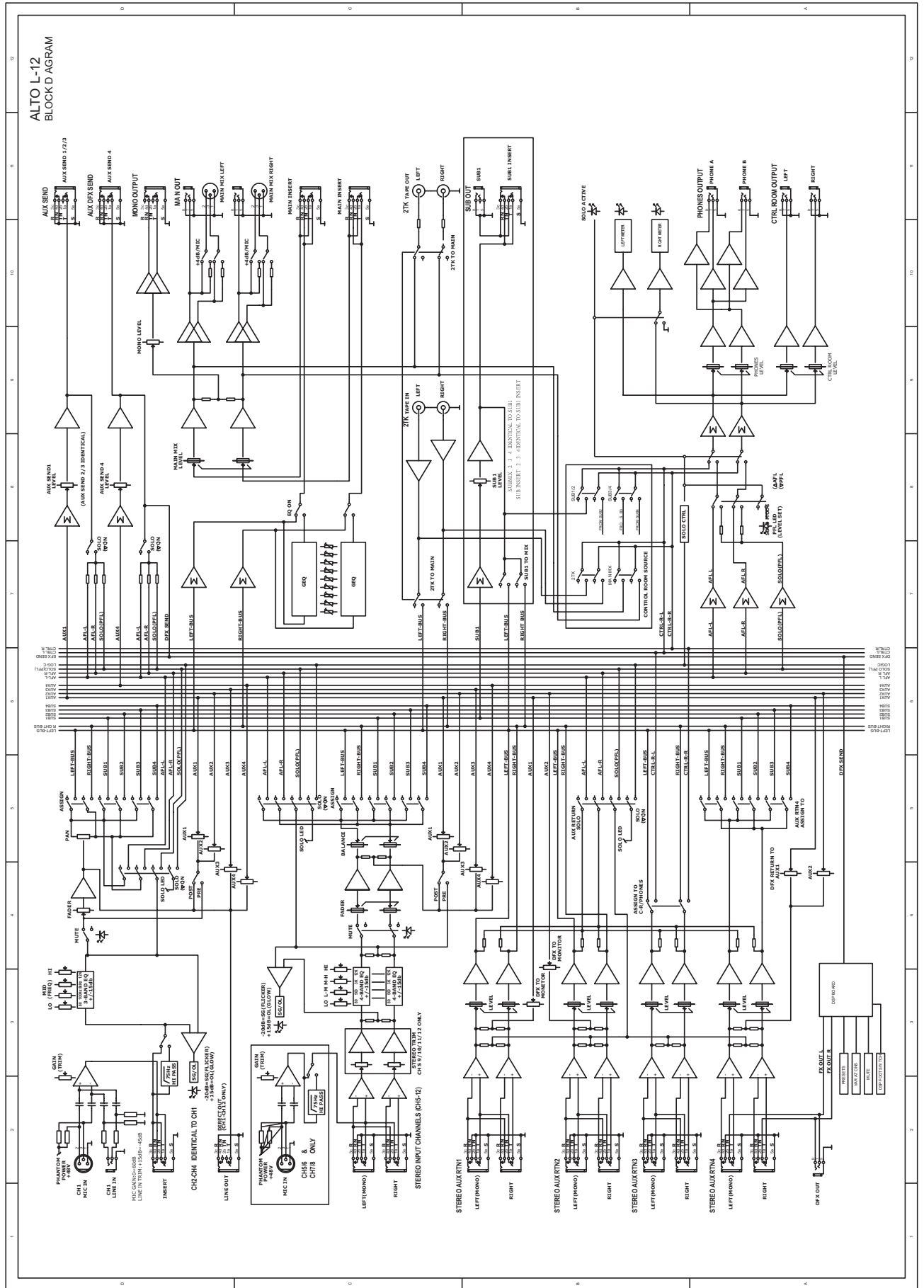

8. TECHNICAL SPECIFICATION

Mono input channels		
	Microphone input	electronically balanced, discrete input configuration
	Frequency response	10Hz to 55kHz, +/- 3dB
	Distortion (THD & N)	0.005% at +4dBu, 1kHz
	Gain range	0dB to 60dB (MIC)
	SNR (Signal to Noise Ratio)	115dB
	Line input	electronically balanced
	Frequency response	10Hz to 55kHz, +/- 3dB
	Distortion (THD & N)	0.005% at +4dBu, 1kHz
	Sensitivity range	+15dBu to - 45dBu
Stereo input channels		
	Line input	Balanced/unbalanced
	Frequency response	10Hz to 55kHz, +/- 3dB
	Distortion (THD & N)	0.005% at +4dBu, 1kHz
Impedances		
	Microphone input	1.4kOhm
	Channel Insert return	2.5kOhm
	All other inputs	10kOhm or greater
	Tape out	1kOhm
	All other output	120Ohm
Equalization		
	Hi shelving	+/- 15dB @12kHz
	Mid bell (mono)	+/- 15dB @100Hz to 8kHz
	Hi Mid (stereo)	+/- 15dB @ 3kHz
	Mid low (stereo)	+/- 15dB @500Hz
	Low shelving	+/- 15dB @80Hz
	Low Cut filter	75Hz, 18dB/oct.
DSP Section		
	A/D and D/A converters	24 bit
	DSP resolution	24 bit
	Type of effects	Hall, Room, Vocal & Plate REVERBS
		Mono & Stereo DELAY (max DELAY TIME 650ms)
		Chorus, Flanger & Reverb MODULATIONS
		REVERB+DELAY, REVERB+CHORUS,
		REVERB+FLANGER combinations
	Presets	256
	Controls	16-position PRESET Selector
		16-position VARIATION selector
		PEAK LED
		MUTE SWITCH with LED indicator
Main Mix Section		
	Noise (Bus noise)	Fader 0 dB, channels muted: - 100dBr (ref.:+4dBu)
		Fader 0dB, all input channels assigned and set to
		UNITY gain: - 90dBr (ref.:+4dBu)
	Max output	+22dBu balanced XLR,
		+22dBu unbalanced, 1/4" jacks
	AUX Returns gain range	-∞ to +15dB
	AUX Sends max out	+22dBu

Power supply		
	Main voltage	USA/Canada 100 - 120V~, 60Hz
		Europe 210 - 240V~, 50Hz
		U.K./Australia 240V~, 50Hz
	Power Consumption	60 watts
	Fuse	100 - 120V~ : T630mAL
		210 - 240V~ : T400mAL
	Main connection	Standard IEC receptacle
Physical		
	Dimension (W×D×H)	415mm×400mm×38/115mm
		(16.34"×15.75"×1.49"/4.53")
	Net weight	6.7Kg (14.78lb)
	Shipping weight	8.3Kg (18.31lb)

9. WARRANTY

1. WARRANTY REGISTRATION CARD

To obtain Warranty Service, the buyer should first fill out and return the enclosed Warranty Registration Card within 10 days of the Purchase Date.

All the information presented in this Warranty Registration Card gives the manufacturer a better understanding of the sales status, so as to purport a more effective and efficient after-sales warranty service.

Please fill out all the information carefully and genuinely, miswriting or absence of this card will void your warranty service.

2. RETURN NOTICE

2.1 In case of return for any warranty service, please make sure that the product is well packed in its original shipping carton, and it can protect your unit from any other extra damage.

2.2 Please provide a copy of your sales receipt or other proof of purchase with the returned machine, and give detail information about your return address and contact telephone number.

2.3 A brief description of the defect will be appreciated.

2.4 Please prepay all the costs involved in the return shipping, handling and insurance.

3. TERMS AND CONDITIONS

3.1 ▲LTO warrants that this product will be free from any defects in materials and/or workmanship for a period of 1 year from the purchase date if you have completed the Warranty Registration Card in time.

3.2 The warranty service is only available to the original consumer, who purchased this product directly from the retail dealer, and it can not be transferred.

3.3 During the warranty service, ▲LTO may repair or replace this product at its own option at no charge to you for parts or for labor in accordance with the right side of this limited warranty.

3.4 This warranty does not apply to the damages to this product that occurred as the following conditions:

- Instead of operating in accordance with the user's manual thoroughly, any abuse or misuse of this product.
- Normal tear and wear.
- The product has been altered or modified in any way.
- Damage which may have been caused either directly or indirectly by another product / force / etc.
- Abnormal service or repairing by anyone other than the qualified personnel or technician.

And in such cases, all the expenses will be charged to the buyer.

3.5 In no event shall ▲LTO be liable for any incidental or consequential damages. Some states do not allow the exclusion or limitation of incidental or consequential damages, so the above exclusion or limitation may not apply to you.

3.6 This warranty gives you the specific rights, and these rights are compatible with the state laws, you may also have other statutory rights that may vary from state to state.

SEIKAKU TECHNICAL GROUP LIMITED
No. 1, Lane 17, Sec. 2, Han Shi West Road, Taichung 40151 Taiwan
<http://www.altoproaudio.com> Tel: 886-4-22313737
email: alto@altoproaudio.com Fax: 886-4-22346757

All rights reserved to ALTO. All features and content might be changed without prior notice. Any photocopy, translation, or reproduction of part of this manual without written permission is forbidden. Copyright © 2005 SEIKAKU GROUP