

User's Manual

ALTO LINK

SPLITTER / MIXER



www.altoproaudio.com
Version 1.3 September 2005

— English —

SAFETY RELATED SYMBOLS



This symbol, wherever used, alerts you to the presence of un-insulated and dangerous voltages within the product enclosure. These are voltages that may be sufficient to constitute the risk of electric shock or death.



This symbol, wherever used, alerts you to important operating and maintenance instructions. Please read.



Protective Ground Terminal



AC mains (Alternating Current)



Hazardous Live Terminal

ON: Denotes the product is turned on.

OFF: Denotes the product is turned off.

WARNING

Describes precautions that should be observed to prevent the possibility of death or injury to the user.

CAUTION

Describes precautions that should be observed to prevent damage to the product.



Disposing of this product should not be placed in municipal waste and should be Separate collection.

WARNING

• Power Supply

Ensure that the mains source voltage (AC outlet) matches the voltage rating of the product. Failure to do so could result in damage to the product and possibly the user.

Unplug the product before electrical storms occur and when unused for long periods of time to reduce the risk of electric shock or fire.

• External Connection

Always use proper ready-made insulated mains cabling (power cord). Failure to do so could result in shock/death or fire. If in doubt, seek advice from a registered electrician.

• Do Not Remove Any Covers

Within the product are areas where high voltages may present. To reduce the risk of electric shock do not remove any covers unless the AC mains power cord is removed.

Covers should be removed by qualified service personnel only.

No user serviceable parts inside.

• Fuse

To prevent fire and damage to the product, use only the recommended fuse type as indicated in this manual. Do not short-circuit the fuse holder. Before replacing the fuse, make sure that the product is OFF and disconnected from the AC outlet.

• Protective Ground

Before turning the product ON, make sure that it is connected to Ground. This is to prevent the risk of electric shock.

Never cut internal or external Ground wires. Likewise, never remove Ground wiring from the Protective Ground Terminal.

• Operating Conditions

Always install in accordance with the manufacturer's instructions.

To avoid the risk of electric shock and damage, do not subject this product to any liquid/rain or moisture. Do not use this product when in close proximity to water.

Do not install this product near any direct heat source.

Do not block areas of ventilation. Failure to do so could result in fire.

Keep product away from naked flames.

IMPORTANT SAFETY INSTRUCTIONS

Read these instructions

Follow all instructions

Keep these instructions. Do not discard.

Heed all warnings.

Only use attachments/accessories specified by the manufacturer.

• Power Cord and Plug

Do not tamper with the power cord or plug. These are designed for your safety.

Do not remove Ground connections!

If the plug does not fit your AC outlet seek advice from a qualified electrician.

Protect the power cord and plug from any physical stress to avoid risk of electric shock.

Do not place heavy objects on the power cord. This could cause electric shock or fire.

• Cleaning

When required, either blow off dust from the product or use a dry cloth.

Do not use any solvents such as Benzol or Alcohol. For safety, keep product clean and free from dust.

• Servicing

Refer all servicing to qualified service personnel only.

Do not perform any servicing other than those instructions contained within the User's Manual.

PREFACE

Dear Customer:

Thanks for choosing ▲LTO LINK SPLITER/MIXER and thanks for choosing one of the results of ▲LTO AUDIO TEAM's work and researches.

For our ▲LTO AUDIO TEAM, music and sound more than a job... are first of all passion and let us say... our obsession! We have been designing professional audio products for a long time in cooperation with some of the major brands in the world in the audio field.

The ▲LTO line presents unparalleled analogue and digital products made by Musicians for Musicians in our R&D Centers in Italy, Netherlands, United Kingdom and Taiwan. The core of our digital audio products is a sophisticated DSP (Digital Sound Processor) and a large range of state of the art algorithms which have been developed by our Software Team for the last 7 years.

Because we are convinced you are the most important member of ▲LTO AUDIO TEAM and the one confirming the quality of our job, we like to share with you our work and our dreams, paying attention to your suggestions and your comments. Following this idea we create our products and we will create the new ones! From our side, we guarantee you and we will guarantee you also in future the best quality, the best fruits of our continuous researches and the best prices.

The ▲LTO LINK SPLITER/MIXER is versatile for you to use in several areas: you can use it as 8-in, 2-out Mixer, 2-in, 8 out splitter. You can also use it as a 6-in, 6-OUT Line Driver or DI-box etc.

Nothing else to add, but that we would like to thank all the people that made the ▲LTO LINK SPLITER/MIXER, and thank our designers and all the ▲LTO staff people who make possible the realization of products containing our idea of music and sound and are ready to support you, our customers, in the best way, conscious that you are our best richness.

Thank you very much
▲LTO AUDIO TEAM

TABLE OF CONTENT

1. INTRODUCTION.....	4
2. FEATURE LIST.....	4
3. CONTROL ELEMENTS.....	4
3.1 The Front Panel	
3.2 The Rear Panel	
4. INSTALLATION & CONNECTION.....	6
4.1 Mains Connection	
4.2 Audio Connection	
4.3 Rack Mounting	
5. APPLICATIONS.....	8
5.1 How to use ▲LTO LINK as the splitter	
5.2 How to use ▲LTO LINK as the mixer	
6. SPECIFICATIONS.....	9
7. SYSTEM BLOCK DIAGRAM.....	10
8.WARRANTY.....	11

1. INTRODUCTION

First, Let's give our sincere appreciation for your confidence in ▲LTO products by purchasing our ▲LTO LINK, SPLITTER / MIXER, it is really the most effective support to us. Herewith, we can assure you that it will be one of the best choices you have ever made, and wish you will enjoy your audio systems with the ▲LTO LINK all the times.

The ▲LTO LINK is in fact the good solutions for many problems of the large scale sound reinforcement systems and PA applications, and it can be used as a splitter or a mixer.

For splitter application, just apply the main signal input from the MAIN IN sockets, and select the SPLITTER mode for each individual channel, then six mono outputs can be gotten. By depressing the MAIN MIX button, two further outputs can be provided.

For mixer application, select the MIXER mode for individual channel, and feed the input signal from the mono input, then six input signals can be mixed together, and output from the MAIN OUT. By depressing the MAIN MIX button, two further inputs can be provided.

Anyway, please reserve your time to read this manual before running the unit, and you will be the real master of your ▲LTO LINK.

2. FEATURE LIST

- 1 rack size.
- SPLIT / MIX switch for each mono channel.
- 2 input, 6+2 outputs splitter.
- 8 Balance / Pan control for each channel.
- Main input and output level control.
- MAIN LINK function allows to route the MAIN IN signal to MAIN OUT, vice versa.
- Level meters for each stage.
- XLR balanced connectors for 4 mono channels, and TRS type for another 2 mono channels.
- Dual voltage unit for global operation.

3. CONTROL ELEMENTS

On the ▲LTO LINK, except for the main common section, there are total six same mono channels. Each channel is presented with two rotary controls, one button, and four LEDs.

3.1 The Front Panel

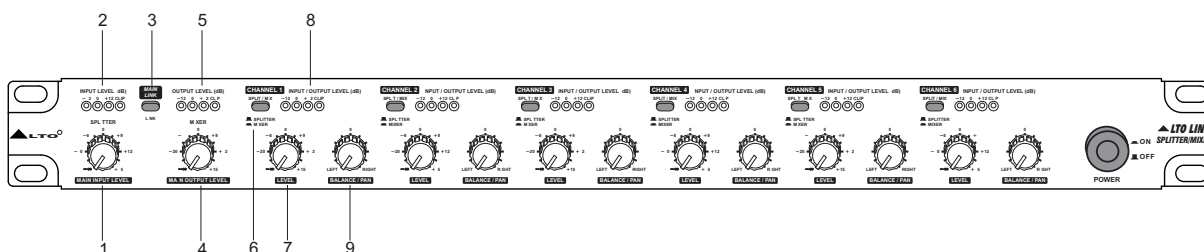

(1). MAIN INPUT LEVEL control

This knob is used to adjust the level of the main input signal, and its adjustable range goes from $-\infty$ to +15dB.

(2). INPUT LEVEL meter

This 4-digit meter tells you the level of the main input signal. While the Clip LED lights up, please turn down the main input signal, otherwise, the system will be distorted.

(3). MAIN LINK control

Use this switch to link the MAIN IN with the MAIN OUT.

(4). MAIN OUTPUT LEVEL control

This knob is used to adjust the level of the main output signal, and its adjustable range goes from $-\infty$ to +15dB.

(5). OUTPUT LEVEL meter

This 4-digit meter tells you the level of the main output signal. While the Clip LED lights up, please turn down the main signal at either each input stage or the main output stage, otherwise, the system will be distorted.

(6). SPLIT / MIX

Use this switch to select the specific operational mode for each individual mono channel.

For SPLITTER mode, please let the switch released, and the main input signal can then be split into each mono channel output.

For MIXER mode, please engage this switch, and now, the mono channel input signal will be sent to the main output bus, combined with the main input signal on condition that the MAIN LINK is activated, you can get the mixed signal output from the MAIN OUT sockets.

Further, also for the MIXER mode, you can route the mono channel input signal to the mono channel output directly.

(7). LEVEL control for each channel

This knob is used to adjust the level of each mono channel, and its adjustable range goes from -∞ to +15dB, definitely,

In SPLITTER mode, this control is used to determine the output level of each individual mono channel.

While in MIXER mode, this control can be used to determine how much the mono channel input signal is sent to the main output bus and/or each individual mono channel output.

(8). INPUT / OUTPUT LEVEL meter

This 4-digit meter tells you the output level of each mono channel, while the Clip LED lights up, please turn down the level control, otherwise, this channel will be distorted.

(9). BALANCE / PAN control

Generally, the main section uses the stereo input and output, while, for each individual channel, mono application is configured.

So, if the stereo main signal is split into the mono channel output, or the mono input signal is routed to the stereo main output bus, please use this knob to determine the proportion between the left and the right.

3.2 The Rear Panel

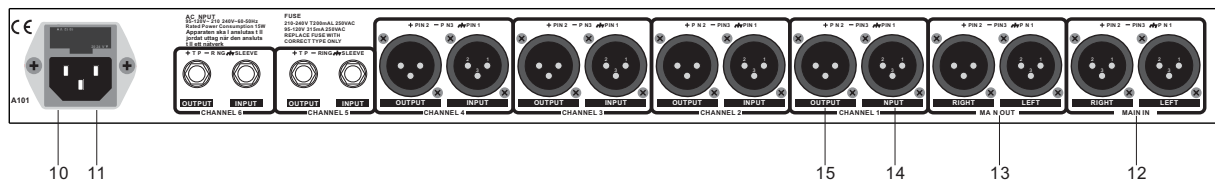

(10). FUSE HOLDER / VOLTAGE SELECTOR

This is a dual voltage unit. Before you attempt to connect and operate the unit, please make sure that your local voltage matches the voltage on the fuse-holder cover.

Caution: The fuse protecting the AC supplies circuits of this unit. The fuse can only be changed by a qualified technician, in the event of a fault or changing the supply voltage. If the fuse continues to blow after replacing, discontinue use of this unit before repaired.

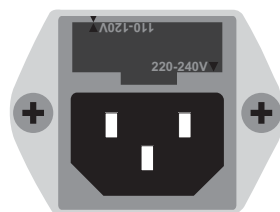

THIS IS SET FOR 110V AC TO 120V AC OPERATION

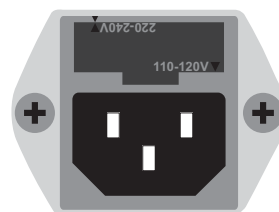

THIS IS SET FOR 220V AC TO 240V AC OPERATION

The fuse-holder above the AC connector on the rear of the chassis has 3 triangular markers(please refer to the above pictures), with two of these triangles opposing each other, your unit is set to the operating voltage printed next to these markers.

To change, pull fuse-holder out and rotate 180°, then push in again.

(11). AC inlet

This connector is meant for the connection of the supplied main cord. Do not insert power cable into the unit until the voltage has been correctly set. Do not plug power cable into AC power until voltage has been correctly set.

(12). MAIN INPUTS

These two XLR balanced connectors are used to input the main stereo signal. In SPLITTER mode, it can be split into each mono channel output.

(13). MAIN OUTPUTS

These two XLR balanced connectors are used to output the main stereo signal. By depressing the MAIN LINK, it can be linked with the MAIN IN directly.

(14). INPUT for the mono channel

For Channel 1~4, use the XLR balanced connectors to input the mono signal, while, for Channel 5~6, please use the TRS type.

(15). OUTPUT for the mono channel

For Channel 1~4, use the XLR balanced connectors to output the mono signal, while, for Channel 5~6, please use the TRS type.

4. INSTLATION & CONNECTION

4.1 Mains Connection

This is a dual voltage unit. Please ensure that the ▲LTO LINK is set to the correct supply voltage before plugging the power cord into the wall outlet, use the same fuse as marked on the fuse holder at the AC power connection socket.

Do not insert power cord into the unit until voltage has been correctly set. Do not plug the power cord into AC power until voltage has been correctly set.

The mains connection of the ▲LTO LINK is made by using the enclosed mains cord and a standard IEC receptacle. It meets all of the international safety certification requirements.

4.2 Audio Connection

The ▲LTO LINK presents with balanced XLR connectors and 1/4" TRS phone jack and it can be interfaced by several ways to support a variety of applications without any signal loss.

a. Wiring Configuration

Either the 1/4" TRS (Tip-Ring-Sleeve) phone jack or the XLR servo connector can be wired in balanced and unbalanced modes, which will be determined by the actual application status, Please wire your systems as the following examples:

- For 1/4" Phone jack

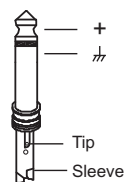

TS Type Unbalanced

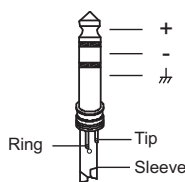

TRS Type Balanced

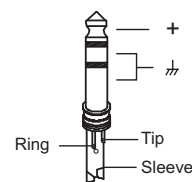

TRS Type Unbalanced

- For XLR connector

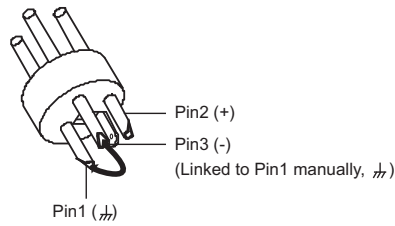

XLR Type Unbalanced

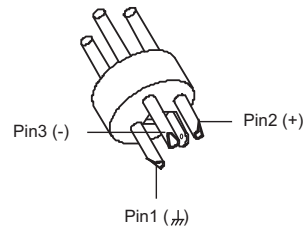

XLR Type Balanced

b. In Line Connection

For these applications, the ▲LTO LINK provides XLR connectors and 1/4" TRS phone jack to easily interface with most professional audio devices. Follow the configuration examples below for your particular connection.

- Balanced

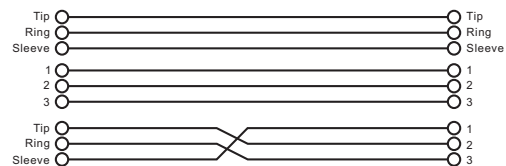
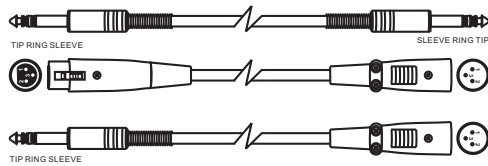

- Unbalanced

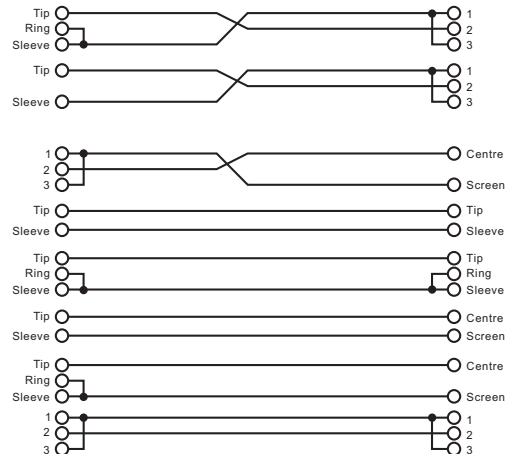
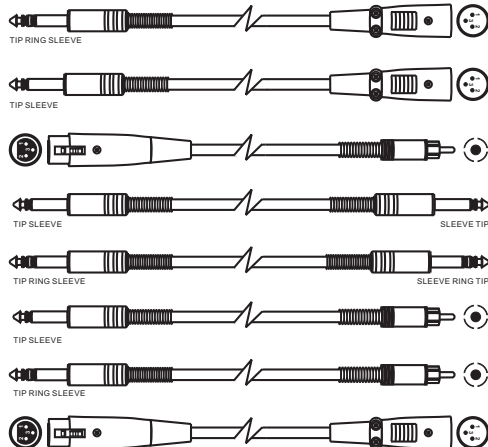

4.3 Rack Mounting

The most secure mounting is on a universal rack shelf available from various rack manufactures or your music dealer. The ▲LTO LINK fits into one standard 19" rack unit of space. Please allow at least an additional 4" depth for the connectors on the rear panel. Be sure that there is enough air space around the unit for sufficient ventilation and please do not place the ▲LTO LINK on high temperature devices such as power amplifiers etc. to avoid overheating.

5. APPLICATIONS

From the panel introduction on the chapter 3, you must have caught a clear answer to "What is it?" in your mind as to our ▲LTO LINK, SPLITTER / MIXER, hereafter, we will show you the further explanation on "How to use it?", so that, you can be the real master of this unit.

5.1 How to use ▲LTO LINK as the splitter

Sometimes, in the large scale PA / sound reinforcement systems, you may be disturbed by this kind of problems: one pre-send signal needs to be monitored by several groups, or the main mix output of the console should be transited to several power amplifiers, etc.

And now, with your ▲LTO LINK, you will get the best solution.

Connect the ▲LTO LINK into your systems as the demonstrated, you can split a specific main input signal into up to 6 outputs. With the MAIN LINK button depressed, 2 further outputs are added.

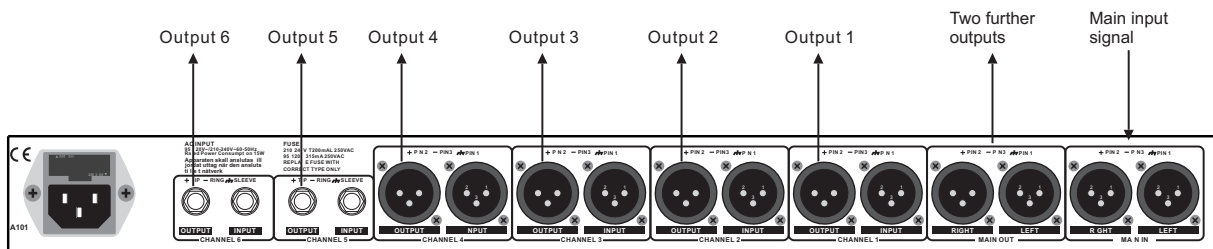

In this application, use the SPLIT/MIX switch to select the SPLITTER operational mode for each mono channel, apply the main signal from the MAIN IN sockets, and get the 6 outputs from the mono OUTPUT sockets of each channel.

While the MAIN LINK is engaged, the MAIN OUT will also be linked with the MAIN IN signal, and two further outputs are provided.

5.2 How to use ▲LTO LINK as the mixer

This application is widely used for the mixing of one group main stereo signal with several mono signals.

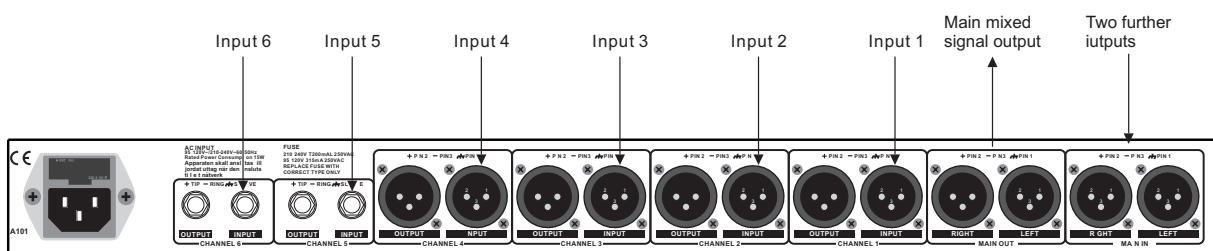

In this application, use the SPLIT/MIX switch to select the MIXER operational mode for each mono channel, input the signal from the mono INPUT of each channel, and output the main mixed signal from the MAIN OUT sockets. While the MAIN LINK is engaged, the MAIN IN will also be linked with the MAIN OUT signal, and two further input signals can be mixed with the main output signal.

6. SPECIFICATIONS

AUDIO INPUTS	Connectors	XLR and 1/4" TRS
	Type	RF filtered, servo balanced input
	Impedance	50 kOhms balanced, 25 kOhms unbalanced
	Nominal operating level	10 dBV to +4 dBu
	Max. input level	+21 dBu balanced and unbalanced
	CMRR	Typ. 40 dB, > 55 dB @ 1 kHz
AUDIO OUTPUTS	Connectors	XLR and 1/4" TRS
	Type	Electronically servo balanced output stage
	Impedance	60 Ohms balanced, 30 Ohms unbalanced
	Max. output level	+22 dBu balanced and unbalanced
SYSTEM SPECIFICATIONS	Frequency response	5 Hz to 200 kHz, +/- 3 dB
	S/N ratio	>95 dBu, unweighted, 22 Hz to 22 kHz
	THD	0.002 % typ. @ +4 dBu, 1kHz, gain 1
FUNCTION CONTROLS	Main input level	variable
	Main output level	variable
	Level	variable for each channel
	Balance/pan	placing in the stereo field
FUNCTION SWITCHES	Main Link	links the main input signal to the main output
	Split/mix	changeover from split to mix mode for each channel
INDICATORS	Input level (main)	4 digit LED display: 12/0/+12/Clip
	Output level (main)	4 digit LED display: 12/0/+12/Clip
	Input/output level	4 digit LED display: 12/0/+12/Clip
POWER SUPPLY	Mains Voltages	USA/Canada 120V ~, 60 Hz
	U.K./Australia	240V ~, 50 Hz
	Europe	230V ~, 50 Hz
		General Export Model 100 120V ~, 200 240V ~, 50 60 Hz
	Power Consumption	max. 15 Watts
	Fuse	95 120 V ~: T 315 mA H
		210 240 V ~: T 200 mA H
Mains Connection	Standard IEC receptacle	
PHYSICAL WEIGHT	Dimensions (H*W*D)	483(W)×217(D)×44(H)mm (19"×8.54"×1.7")
	Net Weight	3 kg(6.4lb)
	Shipping Weight	3.8 kg

7. SYSTEM BLOCK DIAGRAM

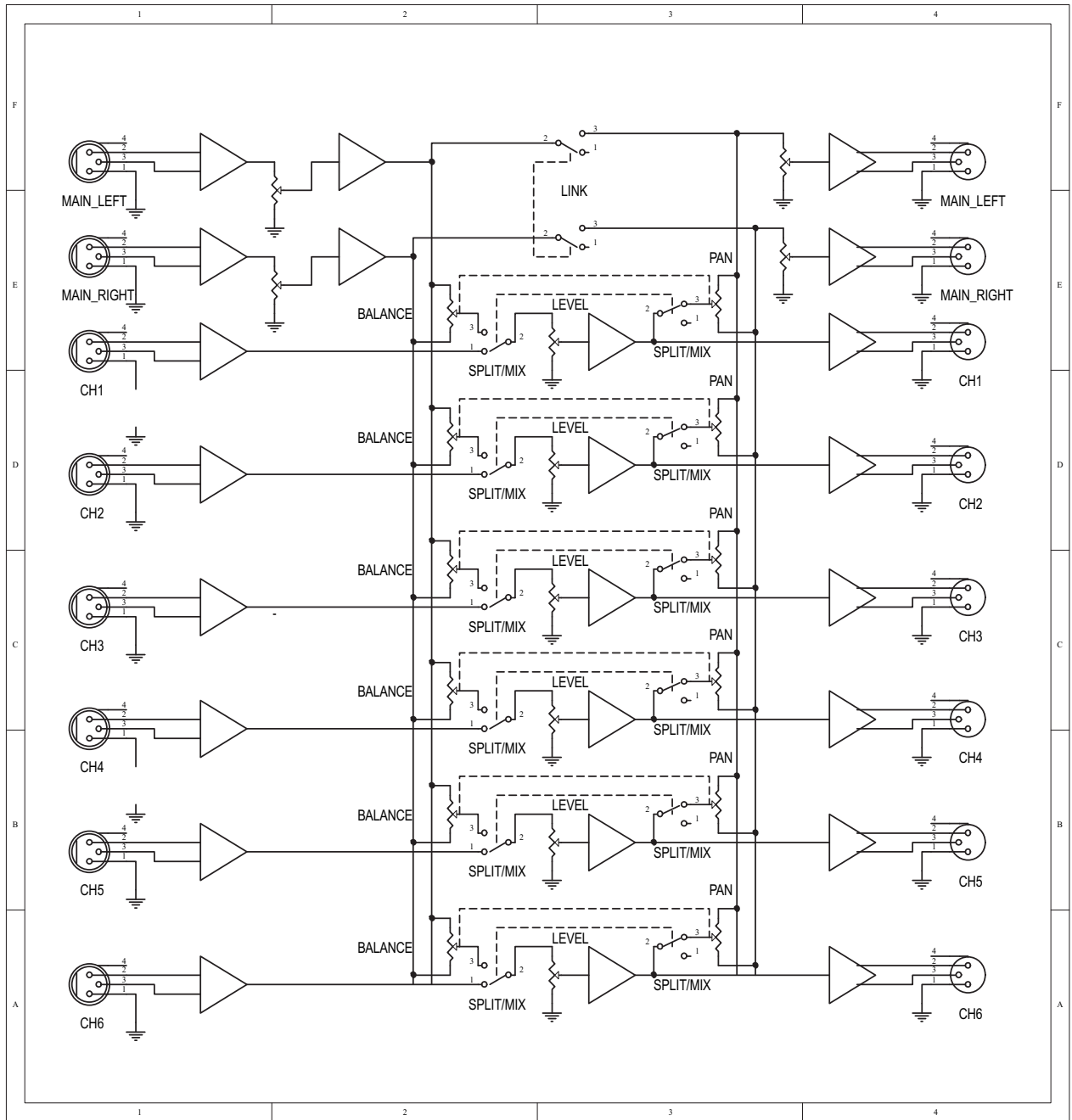

8. WARRANTY

1. WARRANTY REGISTRATION CARD

To obtain Warranty Service, the buyer should first fill out and return the enclosed Warranty Registration Card within 10 days of the Purchase Date.

All the information presented in this Warranty Registration Card gives the manufacturer a better understanding of the sales status, so as to purport a more effective and efficient after-sales warranty service.

Please fill out all the information carefully and genuinely, miswriting or absence of this card will void your warranty service.

2. RETURN NOTICE

2.1 In case of return for any warranty service, please make sure that the product is well packed in its original shipping carton, and it can protect your unit from any other extra damage.

2.2 Please provide a copy of your sales receipt or other proof of purchase with the returned machine, and give detail information about your return address and contact telephone number.

2.3 A brief description of the defect will be appreciated.

2.4 Please prepay all the costs involved in the return shipping, handling and insurance.

3. TERMS AND CONDITIONS

3.1 ▲LTO warrants that this product will be free from any defects in materials and/or workmanship for a period of 1 year from the purchase date if you have completed the Warranty Registration Card in time.

3.2 The warranty service is only available to the original consumer, who purchased this product directly from the retail dealer, and it can not be transferred.

3.3 During the warranty service, ▲LTO may repair or replace this product at its own option at no charge to you for parts or for labor in accordance with the right side of this limited warranty.

3.4 This warranty does not apply to the damages to this product that occurred as the following conditions:

- Instead of operating in accordance with the user's manual thoroughly, any abuse or misuse of this product.
- Normal tear and wear.
- The product has been altered or modified in any way.
- Damage which may have been caused either directly or indirectly by another product / force / etc.
- Abnormal service or repairing by anyone other than the qualified personnel or technician.

And in such cases, all the expenses will be charged to the buyer.

3.5 In no event shall ▲LTO be liable for any incidental or consequential damages. Some states do not allow the exclusion or limitation of incidental or consequential damages, so the above exclusion or limitation may not apply to you.

3.6 This warranty gives you the specific rights, and these rights are compatible with the state laws, you may also have other statutory rights that may vary from state to state.

SEIKAKU TECHNICAL GROUP LIMITED
No. 1, Lane 17, Sec. 2, Han Shi West Road, Taichung 40151 Taiwan
<http://www.altoproaudio.com> Tel: 886-4-22313737
email: alto@altoproaudio.com Fax: 886-4-22346757

All rights reserved to ALTO. All features and content might be changed without prior notice. Any photocopy, translation, or reproduction of part of this manual without written permission is forbidden. Copyright © 2005 SEIKAKU GROUP