

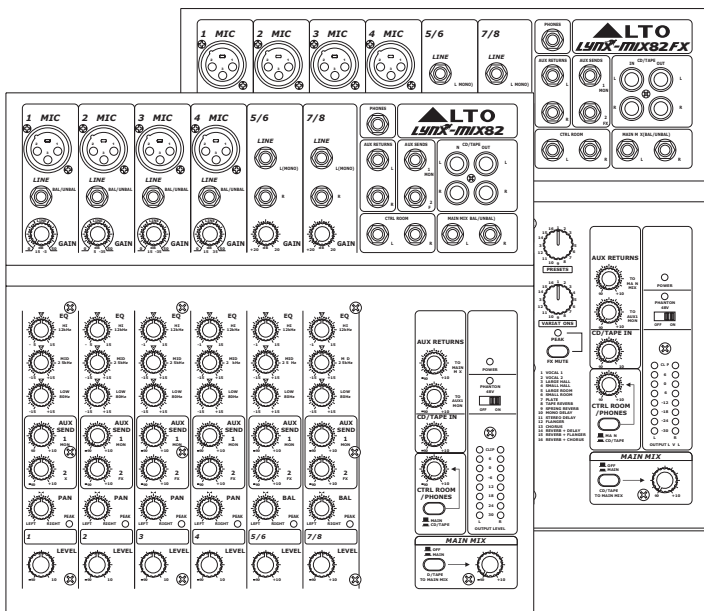

MUSIC, PASSION, DESIGN

User's Manual

LYNX-MIX82/ LYNX-MIX82FX 8-CHANNEL MIXING CONSOLE WITH DIGITAL EFFECTS



www.altoproaudio.com
Version 1.0 Fer. 2009

English

IMPORTANT SAFETY INSTRUCTION



TO REDUCE THE RISK OF ELECTRIC SHOCK PLEASE DO NOT REMOVE THE COVER OR THE BACK PANEL OF THIS EQUIPMENT. THERE ARE NO PARTS NEEDED BY USER INSIDE THE EQUIPMENT. FOR SERVICE, PLEASE CONTACT QUALIFIED SERVICE CENTERS.

 This symbol, wherever used, alerts you to the presence of an insulated and dangerous voltages within the product enclosure. These are voltages that may be sufficient to constitute the risk of electric shock or death.

 This symbol, wherever used, alerts you to important operating and maintenance instructions. Please read.

 Protective Ground Terminal
AC mains (Alternating Current)

 Hazardous Live Terminal

ON: Denotes the product is turned on.

OFF: Denotes the product is turned off.

CAUTION

Describes precautions that should be observed to prevent damage to the product.

1. Read this Manual carefully before operation.
2. Keep this Manual in a safe place.
3. Be aware of all warnings reported with this symbol. 
4. Keep this Equipment away from water and moisture.
5. Clean it only with dry cloth. Do not use solvent or other chemicals.
6. Do not damp or cover any cooling opening. Install the equipment only in accordance with the Manufacturer's instructions.
7. Power Cords are designed for your safety. Do not remove Ground connections! If the plug does not fit your AC outlet, seek advice from a qualified electrician. Protect the power cord and plug from any physical stress to avoid risk of electric shock. Do not place heavy objects on the power cord. This could cause electric shock or fire.
8. Unplug this equipment when unused for long periods of time or during a storm.
9. Refer all service to qualified service personnel only. Do not perform any servicing other than those instructions contained within the User's Manual.
10. To prevent fire and damage to the product, use only the recommended fuse type as indicated in this manual. Do not short circuit the fuse holder. Before replacing the fuse, make sure that the product is OFF and disconnected from the AC outlet.

WARNING

To reduce the risk of electric shock and fire, do not expose this equipment to moisture or rain.



Dispose of this product should not be placed in municipal waste and should be separate collection.

11. Move this Equipment only with a cart, stand, tripod, or bracket, specified by the manufacturer, or sold with the Equipment. When a cart is used, use caution when moving the cart / equipment combination to avoid possible injury from tip over. 

12. Permanent hearing loss may be caused by exposure to extremely high noise levels. The US. Government's Occupational Safety and Health Administration (OSHA) has specified the permissible exposure to noise level. These are shown in the following chart:

HOURS X DAY	SPL	EXAMPLE
8	90	Small gig
6	92	train
4	95	Subway train
3	97	High level desktop monitors
2	100	Classic music concert
1,5	102	
1	105	
0,5	110	
0,25 or less	115	Rock concert

According to OSHA, an exposure to high SPL in excess of these limits may result in the loss of heat. To avoid the potential damage of heat, it is recommended that Personnel exposed to equipment capable of generating high SPL use hearing protection while such equipment is under operation.

The apparatus shall be connected to a mains socket outlet with a protective earthing connection.

The mains plug or an appliance coupler is used as the disconnect device, the disconnect device shall remain readily operable.

IN THIS MANUAL:

1. INTRODUCTION.....	1
2. FEATURES.....	1
3. QUICK START.....	4
4. CONTROL ELEMENTS.....	5
5. INSTALLATION & CONNECTION.....	11
6. APPENDIX.....	13
7. PRESET LIST.....	13
8. BLOCK DIAGRAM.....	14
9. TECHNICAL SPECIFICATIONS.....	15
10. WARRANTY.....	16

1. INTRODUCTION

Thank you for purchasing the LTO LYNX-MIX82(FX) 8-channel mixing console with 24-bit digital multi-effect. It is just one of the many Alto products that a talented, multinational Team of Audio Engineers and Musicians have developed with their great passion for music. Your LYNX-MIX82(FX) is a remarkable compact mixing desk that does not find many equals in the market today. With 4 microphone and 2 stereo Line-level inputs for small live performances, small studio recording and general PA applications, your LYNX-MIX82(FX) also includes a 24-Bit digital multi-effect with 16 Factory Presets . There is a three bands EQ on all input channels and separate Main Mix and Control Room outputs for operation with different volume settings. Use it for small GIGs and RECORDING. Your LYNX-MIX82(FX) also is a flexible tool for your Multi-media presentations.

Enjoy your LYNX-MIX82(FX) and make sure to read this Manual carefully before operation!

2. FEATURES

- 4 MIC input channels with gold plated XLR and balanced LINE input
- 2 stereo input channels with balanced TRS jacks
- Ultra-low noise discrete MIC pre-amps with +48V Phantom power
- Extremely high headroom offering extra dynamic range
- Balanced inputs for optimal signal integrity
- Warm, natural 3-band EQ on each channel
- Built-in 24 bits digital effects processor(F or LYNX-MIX82FX Model)
- Peak LED on each channel
- 2 AUX sends pre channel for external effects and monitoring
- Main output, Control room and headphone outputs
- 2- Track inputs assignable to main mix, control room/headphone outputs
- Highly accurate 8-segment bar graph meters

3. QUICK START

This is the fastest way to get something out from your LYNX-MIX82(FX), if you have a keyboard and a microphone.

- a. With the Main switch in OFF position, connect the supplied AC Adapter to your LYNX-MIX82(FX) first and then into the AC outlet, making sure that the available voltage is the same with your LYNX-MIX82(FX).
- b. Before turning on the LYNX-MIX82(FX), you shall connect it to a power amplifier and speakers. Turning off the mixer BEFORE the power amplifier.
- c. Plug the microphone into Channel 1 MIC IN.
- d. Turn down AUX and LEVEL controls on the input channel.
- e. Put the EQ controls on center position.
- f. Turn on your LYNX-MIX82(FX).
- g. With LEVEL control on "0" position, sing or speak in to the microphone with normal volume and adjust the GAIN control so that the PEAK LED only blink occasionally.
- h. If you like, you can adjust the equalization at this stage.
- i. Turn up MAIN MIX LEVEL until you get a comfortable volume.
- j. Connect your stereo keyboard into CH 5/6 and repeat the same sequence.

Here you are. It is your first mix with your LYNX-MIX82(FX).

Once you have finished your working session you shall turn the mixer off AFTER the power amplifier. Before disconnecting the AC Adapter always turn-off your LYNX-MIX82(FX). Do not use solvents to clean your LYNX-MIX82(FX). A dry and clean cloth will be OK.

3. QUICK START

SMALL GIG

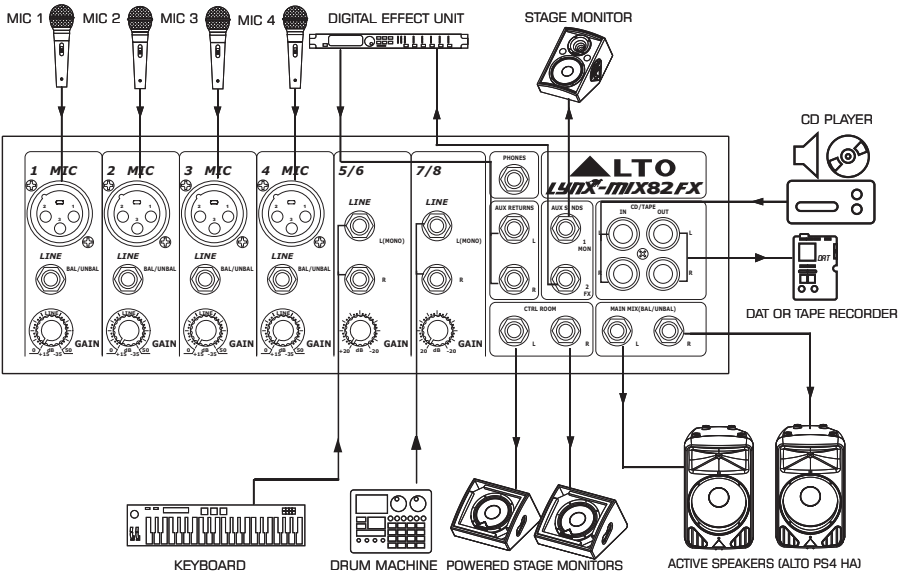

BAR, PUB, RESTAURANT

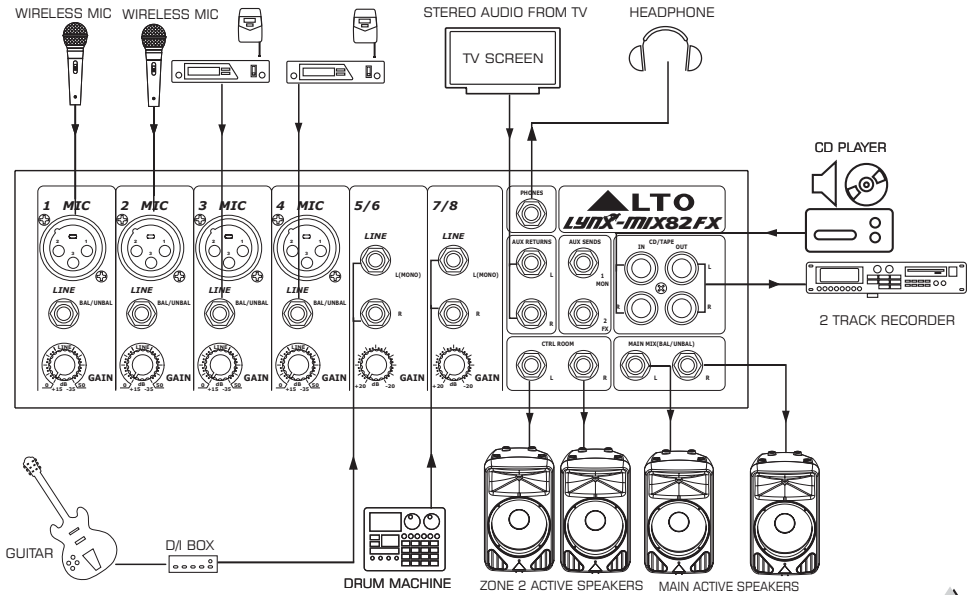

LYNX-MIX82(FX)

1 MIC

2 MIC

3 MIC

4 MIC

5/6

7/8

PHONES

AUX RETURNS

AUX SENDS

CD/TAPE

CTRL ROOM

MAIN MIX(BAL/UNBAL)

EQ

EQ

EQ

EQ

EQ

EQ

AUX SEND

AUX SEND

AUX SEND

AUX SEND

AUX SEND

AUX SEND

PAN

PAN

PAN

PAN

BAL

BAL

1

2

3

4

5/6

7/8

PRESETS

VARIATIONS

PEAK

FX MUTE

AUX RETURNS

CD/TAPE IN

CTRL ROOM / PHONES

MAIN MIX

POWER

PHANTOM 48V

OFF ON

CLIP

1 VOCAL 1

2 VOCAL 2

3 LARGE HALL

4 SMALL HALL

5 LARGE ROOM

6 SMALL ROOM

7 PLATE

8 TAPE REVERB

9 SPRING REVERB

10 MONO DELAY

11 STEREO DELAY

12 FLANGER

13 CHORUS

14 REVERB + DELAY

15 REVERB + FLANGER

16 REVERB + CHORUS



4. CONTROL ELEMENTS

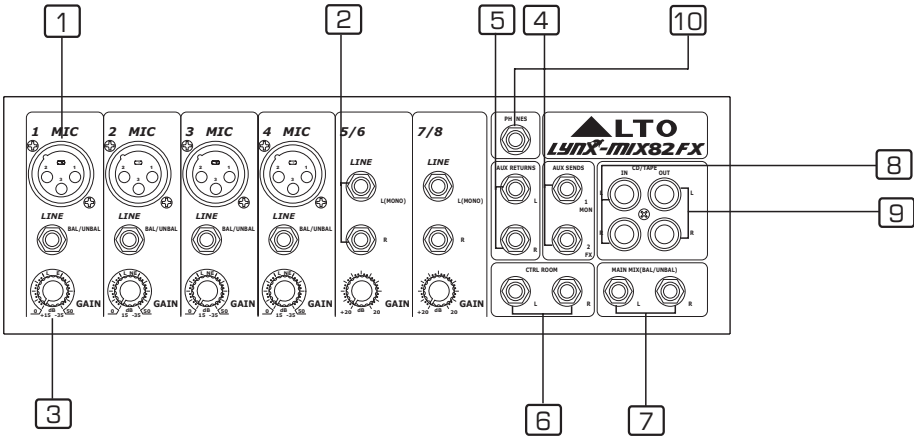

1 MIC INPUT (1 to 4)

Your LYNX-MIX82(FX) is equipped with 4 low-noise microphone preamplifiers with optional phantom power, 50 dB of Gain and 115 dB of S/N ratio. You can connect almost any type of microphone. Dynamic microphones do not need phantom power. Use phantom power only with condenser microphones but make sure that the phantom power button is disengaged before connecting the microphone. Phantom power will not damage your dynamic microphones but it may damage tube or ribbon microphones so make sure to read the microphone instructions manual before engaging phantom power. Use switch (24) to activate/deactivate phantom power. These two channels are also equipped with 1/4" TRS balanced/unbalanced LINE-IN plugs to connect line-level instruments such as keyboards, drum machines and effect devices.

NOTE: Never try to connect a line-level signal to the XLR MIC input when the phantom power is engaged or you may seriously damage your equipment.

2 STEREO LINE INPUTS (5 to 8)

These are channels 5/6, and 7/8. They are organised in stereo pair and provided with 1/4" TRS phone sockets. If you connect only the left jack, the input will operate in mono mode, that is the mono signal will appear on both input channels. You can use these inputs with a stereo keyboard, drum machine, etc.

3 GAIN

This control is provided with 2 different indication rings: one is for 1-4 channels, with a range of 0~50dB when MIC is used and a range of +15~-35dB when LINE is used, the other for 5-8 channels with a range of +20~-20dB. For optimum operation, you shall set this control in a way that the PEAK LED will light up only occasionally in order to avoid distortion on the input channel.



4. CONTROL ELEMENTS

4 AUX SENDS

For AUX1(MON) jack, use this to connect the input of an external amplifier or active monitor speaker. For AUX2(FX) jack, use this to output the line level signal of the AUX2 post fader bus. You can use it to feed the inputs of a stereo multi-effects (you will need a Y-type cable).

5 AUX RETURNS

You can use these stereo 1/4" phone sockets to return the stereo signal of an effect unit to the Main Mix. Alternatively you can use them as an extra auxiliary input and using the AUX RETURN level control as volume control. The signal will be sent directly to MAIN MIX control.

6 CTRL ROOM OUTPUT

These 1/4" phone sockets will be used to send the signal to a pair of powered Studio Monitor speakers or to a second set of PA.

7 MAIN MIX OUTPUTS

This stereo output is controlled by the Main Mix Level on the Master section and will send the audio signal to an amplifier or to a pair of active speakers. The output level can be varied from $-\infty$ to +10 dB.

8 CD/TAPE IN

Use the Tape input to connect a CD Player, Tape, DAT, iPod or any other line-level source. You can send this signal either to CONTROL ROOM OUTPUT and/or to the MAIN MIX OUTPUT using the relative CD/TAPE TO select buttons.

9 CD/TAPE OUT

These RCA jacks will route the main mix signal into a tape or DAT recorder.

10 PHONES

This socket will be used to send the signal to a pair of headphones.

CHANNEL STRIP

11 LEVEL

This knob controls the channel's level from $-\infty$ to +10 dB.

12 PEAK LED

This red LED will let you know about the status of the signals processed into your LYNX-MIX82(FX). Connect a microphone or an instrument to your LYNX-MIX82(FX) and sing/play at normal volume. Set the level control of that channel so that the PEAK LED lights-up only occasionally. If this LED is always on, you are experiencing a lot of distortion and you should turn the GAIN control down or reduce the EQ boosting. If this led never lights up, turn the GAIN control up again.



4. CONTROL ELEMENTS

13 PAN/BAL

This is the PANORAMA control, or balance control. You can adjust the stereo image of the signal via this control. Keep this control in center position and your signal will be positioned in the middle of stage. Turn this control fully counter clockwise and the signal will be present only on the left speaker and vice-versa. Of course a large number of intermediate positions is available.

14 AUX

These two controls are used to adjust the level of the signal sent to AUX buses, and their adjustable range goes from $-\infty$ to +10dB. AUX1 is configured as PRE(MON)-FADER, so, generally, it can be used for monitor application. While AUX2 is configured as POST(FX)-FADER, therefore, most of the times, it will be used for effects and processors input, however, you can also changed it to PRE(MON)-FADER configuration according to the specific application. (For more detail, please see chapter 6.) In this typical compact unit, excluding sending out directly to the external effect or processor equipment, AUX SEND2 will also be sent to the internal onboard effect module.

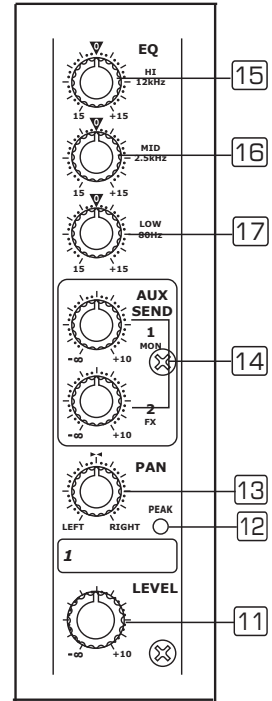

3-BAND EQ

You have three EQ control for each mono and stereo input channel each providing +/-15 dB of boost and cut (MID is +/-12 dB). The signal will be unaffected when the controls are on center position. You may use an external equalizer to make up a mix properly but a master equalizer will not have effect on a single channel and you may overload the signal easily. Individual EQ will give you a much better control on single tracks.

15 HI

If you turn this control up, you will boost all the frequencies above 12 kHz (shelving filter). You will add transparency to vocals and guitar and also make cymbals crispier. Turn the control down to cut all frequencies above 12 kHz. In such way, you can reduce sibilances of human voice or reduce the hiss of a Tape player.

16 MID

This is a peaking filter and it will boost/cuts frequencies with their center at 2.5 kHz. This control will affect especially upper male and lower female vocal ranges and also the harmonics of most musical instruments.



4. CONTROL ELEMENTS

17 LOW

If you turn this control up, you will boost all frequencies below 80 Hz. You will give more punch to bass drums and bass guitar; and you will make the male vocalist more "macho". Turn it down and you will cut all the frequencies below 80 Hz. In this way you can avoid low-frequency vibrations and resonance thus preserving the life of your woofers.

MASTER SECTION

18 MAIN MIX LEVEL

This knob controls the level of the signal sent to MAIN OUTPUTS and CD/TAPE OUT. Also AUX RETURNS and CD/TAPE IN signals will be sent to this control.

19 PHONES/CONTROL ROOM LEVEL

This knob controls the signal sent to CONTROL ROOM OUTPUT & PHONES OUTPUT.

20 CD/TAPE IN

This knob controls the signal sent from CD/TAPE IN.

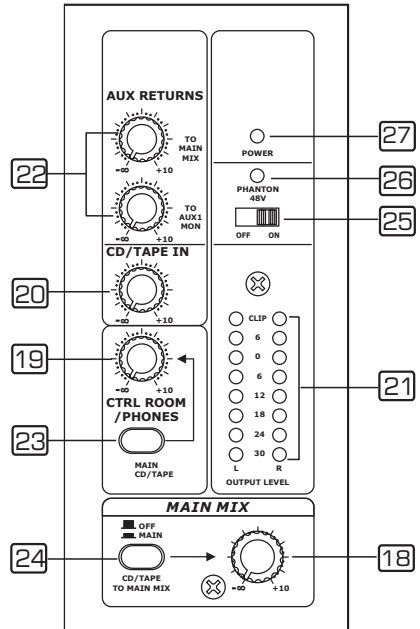

21 OUTPUT LEVEL METERS

These consist of two column of 8 LEDs each ranging from -30 dB to +18 dB (CLIP). The 0 LED corresponds to a level output of 0 dBu. The CLIP LEDs come to life when the output reaches +18 dBu. Set the MAIN MIX level control so that the CLIP LEDs only flashes occasionally. In general, you get a good mix level when the Meter LEDs operate in the range 0 to +6. If you exceed +6, you will get distortion. If even -30 LEDs are sleeping your signal-to-noise ratio will suffer.



4. CONTROL ELEMENTS

22 AUX RETURNS

TO MAIN MIX, This control is used to control the volume of the processed signal sent to Main Mix bus, which can be varied from $-\infty$ to +10 dB.

TO AUX1 MON, This control is used to control the volume of the processed signal sent to Monitor Mix, which can be varied from $-\infty$ to +10 dB.

23 MAIN/CD/TAPE

If you push down the CD/TAPE TO CONTROL ROOM button, the CD/TAPE IN signal will be routed into the Control Room output and the level will be adjusted by the Control Room knob nearby the Main MIX LEVEL knob.

24 CD/TAPE TO MAIN MIX

If you push down the CD/TAPE TO MAIN MIX button, the CD/TAPE IN signal will be routed into the MAIN output and will be adjusted by the MAIN MIX LEVEL knob.

25 PHANTOM PWR Switch

This button will apply +48 Volt Phantom Power only to the 4 XLR MIC input sockets. When condenser microphones are not used, please make sure that the Phantom Power is disengaged.

26 PHANTOM LED

This LED indicates when the PHANTOM POWER is engaged.

27 POWER LED

This LED indicates when your LYNX-MIX82(FX) is switched on.

DSP SECTION(For LYNX-MIX82FX Model)

There is a powerful 24-bit/256 preset digital multi-effects included in your LYNX-MIX82FX Effects include reverbs, chorus, flanger, delay and combinations of the above.

28 PRESETS

This knob will select one of the 16 Factory Presets.

29 VARIATIONS Control

For each of the 16 Factory Presets you can apply up to 16 variations, so in total your LYNX-MIX82FX offers 256 different presets. If you want to know which parameter is modified by this control, please look at the following chart.

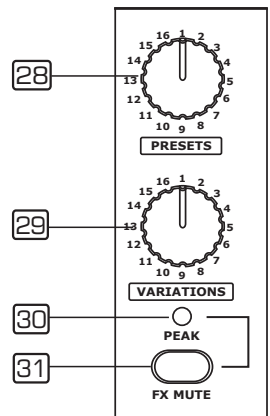



4. CONTROL ELEMENTS

30 PEAK LED

This LED lights up when the input signal is too strong.

31 FX MUTE Switch

This switch is used to activate/deactivate the effect facility.

REAR PANEL

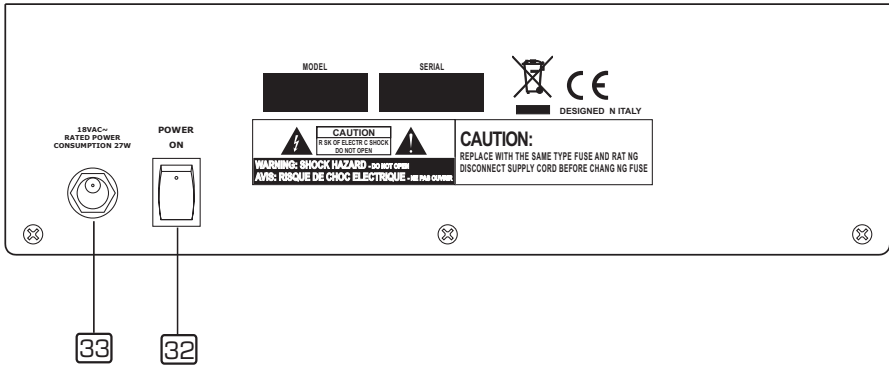

32 POWER SWITCH

This switch is used to turn the main power ON and OFF.

33 AC INPUT

This connector is used to connect the supplied AC 18V Adapter.



5. INSTALLATION AND CONNECTION

Ok, you have got to this point and you are now in the position to successfully operate your LYNX-MIX82(FX) . However, we advise you to read carefully the following section to be the real master of your own mix. Not paying attention enough to the input signal level, to the routing of the signal and the assignment of the signal will result in unwanted distortion, a corrupted signal or no sound at all. So you should follow this procedure for every single channel:

1. Turn down all Input and Output Gain Controls.
2. Connect phantom powered microphones before switching on the +48 Volt phantom power switch.
3. Set the output level of your LYNX-MIX82(FX) or the connected power amplifier at no more than 75%.
4. Now, set the CONTROL ROOM/PHONE level at no more than 50%.
5. Position HI, MID and LOW EQ controls on middle position.
6. Position panoramic (PAN/BAL) control on center position.
7. With a pair of headphones or studio monitor speakers connected apply a Line Level input signal so that the PEAK LED does not light up.
8. While speaking into the microphone (or playing the instrument), adjust the channel level control so that the PEAK LED will blink occasionally, in this way You will maintain good headroom and ideal dynamic range.
9. Now repeat the same sequence for all input channels. The Main LED Meter could move up into the red section. In this case, you can adjust the overall output level through the MAIN MIX control.

Audio Connections

You can connect unbalanced equipment to balanced inputs and outputs. Simply follow these schematics.

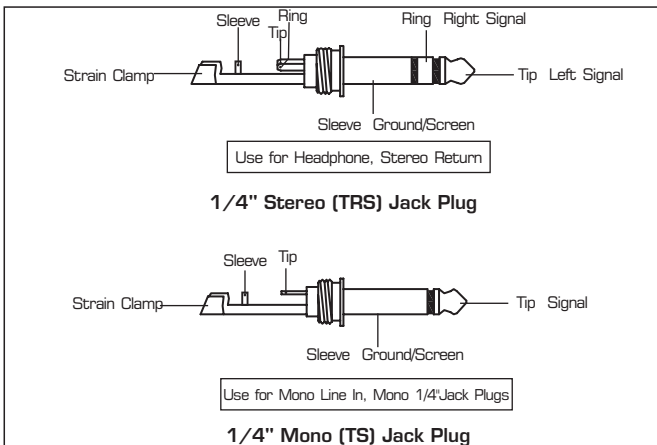



5. INSTALLATION AND CONNECTION

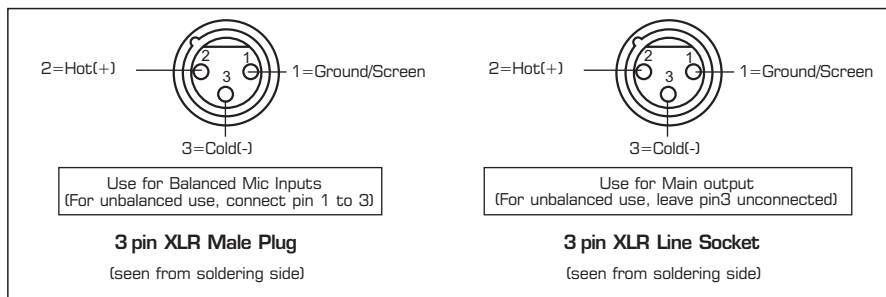

6. APPENDIX

PREFADER AND POSTFADER CONSIDERATIONS

Interesting consideration! Where are the faders in your LYNX-MIX82(FX)?? Actually a fader is usually regarded as a slider, that is a linear potentiometer. All potentiometers in your LYNX-MIX82(FX) are of rotary type but we keep the pre-fader/post-fader description that is quite industry standard and easily understandable. When your LYNX-MIX82(FX) leaves the Alto Factory, the AUX bus of all input channels is wired post-fader. In this way, the Aux bus can be used for the internal or external multi-effect. If you want to use the LYNX-MIX82(FX) Aux bus for powered stage monitors, you should disconnect the above-indicated POST route track and solder the PRE route track like in this drawing. In this way, the signal is routed to the AUX SENDS output before the Channel Level control.

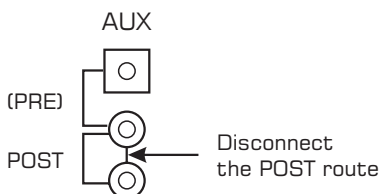

Before

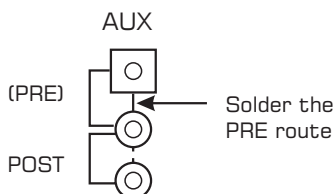

After

7. PRESET LIST

NO.	Preset	Description	Controllable Parameter	
			Parameter	Variable range
1	VOCAL1	Simulate a room with small delay time.	Decay time Pre delay	0.8 1.1s 0 79ms
2	VOCAL2	Simulate a small space with slight decay time	Decay time Pre delay	0.8 2.5s 0 79ms
3	LARGE HALL	Simulate a large acoustic space of the sound.	Decay time Pre delay	3.6 5.4s 23 55ms
4	SMALL HALL	Simulate a stage space of the sound.	Decay time Pre delay	1.0 2.9s 20 45ms
5	LARGE ROOM	Simulate a studio room with many early reflections	Decay time Pre delay	2.9 4.5s 23 55ms
6	SMALL ROOM	Simulate a bright studio room.	Decay time Pre delay	0.7 2.1s 20 45ms
7	PLATE	Simulate the transducers sound like classic bright vocal plate.	Decay time Pre delay	0.6 6.1s 10ms
8	TAPE REVERB	Simulate a record head and multiple playback heads at intervals along the tape.	Decay time Pre delay	1.3 5.4s 0 84ms
9	SPRING REVERB	Simulate the analog transducers' springs lightly stretched sound.	Decay time Pre delay	1.3 5.4s 0 35ms
10	MONO DELAY	Reproduce the sound input on the output after a lapse of time.	Period	60 650ms
11	STEREO DELAY	Recreate the input sound on the stereo output with different time.	Period Feedback	210 400ms 37 73%
12	FLANGER	Simulate to play with another person carrying out same the notes on the same instrument	Rate	0.16 2.79Hz
13	CHORUS	Recreate the illusion of more than one instrument from a single instrument sound	Rate	0.5 5Hz
14	REV.+DELAY	Delay with room effect	Decay period Rev.decay time	211 375ms 1.0 2.9s
15	REV.+FLANGER	Stereo chorus and large room reverb	Flanger Rate Rev.decay time	0.16 2.52Hz
16	REV.+CHORUS	Stereo flanger and large room reverb	Chorus rate Rev.decay time	0.5 4.74Hz 1.5 2.9s

8. BLOCK DIAGRAM

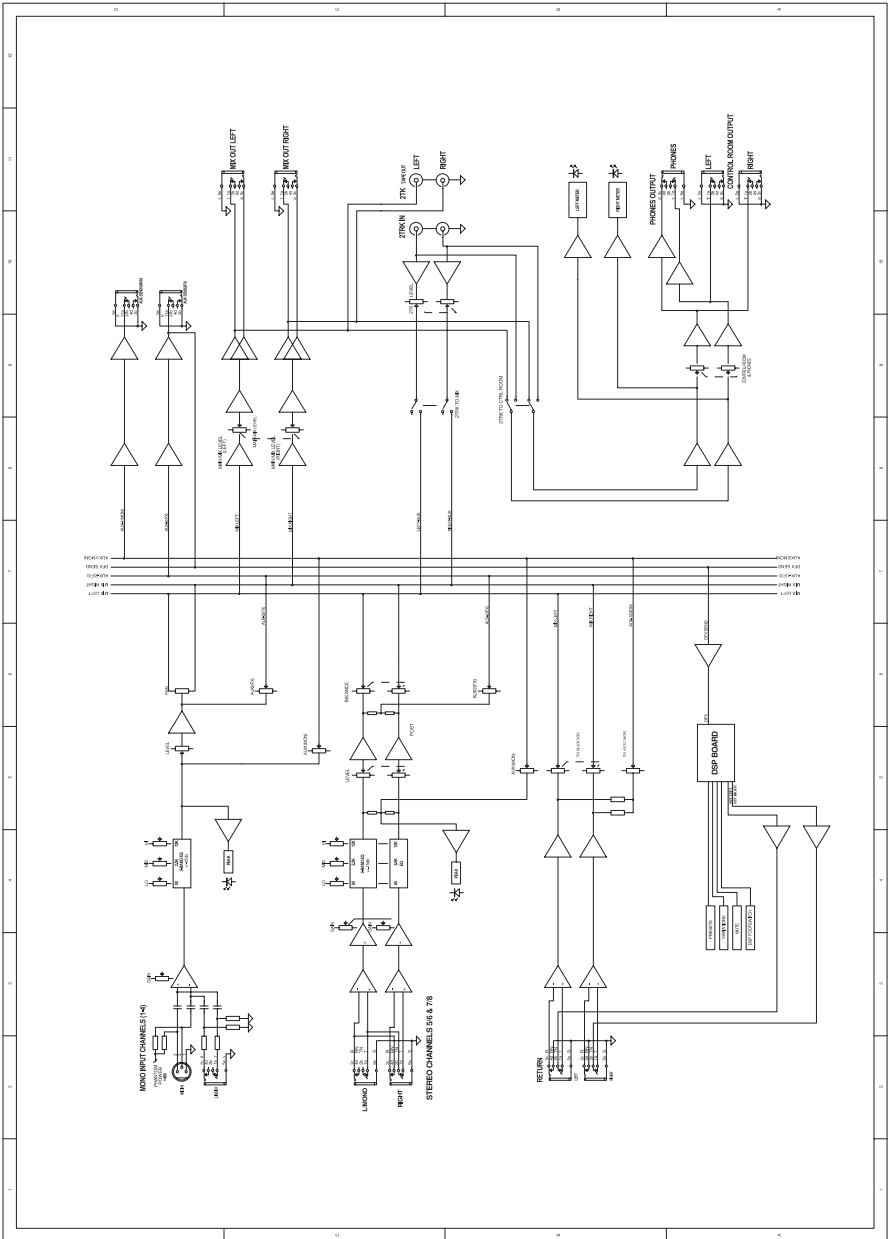

9. TECHNICAL SPECIFICATIONS

Input channels

Microphone input	electronically balanced, discrete input configuration
Frequency response	20 Hz to 22 kHz, +/- 1 dB
Distortion (THD & N)	≤0.005% at +4 dBu, 1 kHz
Gain range	0 dB to 50 dB (MIC)
SNR (Signal to Noise Ratio)	115dB
Line input	electronically balanced
Frequency response	20 Hz to 22 kHz, +/- 1 dB
Distortion (THD & N)	0.005% at +4 dBu, 1 kHz
Sensitivity range	+15 dBu to 35 dBu

Impedances

Microphone input	1.4 k Ohm
All other inputs	10 k Ohm or greater
Tape out	1 k Ohm
All other output	120 Ohm

Equalization

Hi shelving	+/- 15 dB @12 kHz
Mid bell	+/- 15 dB @ 2.5 kHz
Low shelving	+/- 15 dB @ 80 Hz

DSP Section

A/D and D/A converters	24 bit
DSP resolution	24 bit
Type of effects	Hall,Room,Vocal&Plate REVERBS Mono & STEREO DELAY (Max DELAY TIME 650ms) Chorus,Flanger&Reverb MODULATIONS REVERB+DELAY, REVERB=CHORUS, Combinations
Presets	256
Controls	256 position PRESET Selector, CLIP LED, MUTE SWITCH With LED Indicator

Main Mix Section

Noise (bus noise)	Fader 0 dB, channels muted:- 93 dB (ref.:+4 dBu) UNITY gain: - 91 dB (ref.:+4 dBu)
Max output	+22 dBu unbalanced, 1/4" jacks
AUX Returns gain range	∞ to +10 dB
AUX Sends max out	+22 dBu

Power Supply

Main voltage	18V~, 1500mA
Power Consumption	27 Watts

Physical

Dimension(WxDxH)	256*250*72mm
Net Weight	2.3Kg
Shipping weight	16.5Kg(4Pcs)
Volume	

10. WARRANTY

1. WARRANTY REGISTRATION CARD

To obtain Warranty Service, the buyer should first fill out and return the enclosed Warranty Registration Card within 10 days of the Purchase Date. All the information presented in this Warranty Registration Card gives the manufacturer a better understanding of the sales status, so as to purport a more effective and efficient after-sales warranty service. Please fill out all the information carefully and genuinely, miswriting or absence of this card will void your warranty service.

2. RETURN NOTICE

- 2.1 In case of return for any warranty service, please make sure that the product is well packed in its original shipping carton, and it can protect your unit from any other extra damage.
- 2.2 Please provide a copy of your sales receipt or other proof of purchase with the returned machine, and give detail
- 2.3 A brief description of the defect will be appreciated.
- 2.4 Please prepay all the costs involved in the return shipping, handling and insurance.

3. TERMS AND CONDITIONS

- 3.1 ▲LTO warrants that this product will be free from any defects in materials and/or workmanship for a period of 1 year from the purchase date if you have completed the Warranty Registration Card in time.
- 3.2 The warranty service is only available to the original consumer, who purchased this product directly from the retail dealer, and it can not be transferred.
- 3.3 During the warranty service, ▲LTO may repair or replace this product at its own option at no charge to you for parts or for labor in accordance with the right side of this limited warranty.
- 3.4 This warranty does not apply to the damages to this product that occurred as the following conditions:
 - Instead of operating in accordance with the user's manual thoroughly, any abuse or misuse of this product.
 - Normal tear and wear.
 - The product has been altered or modified in any way.
 - Damage which may have been caused either directly or indirectly by another
- 3.5 In no event shall ▲LTO be liable for any incidental or consequential damages. Some states do not allow the exclusion or limitation of incidental or consequential damages, so the above exclusion or limitation may not apply to you.
- 3.6 This warranty gives you the specific rights, and these rights are compatible with the state laws, you may also have other statutory rights that may vary from state to state.

SEIKAKU TECHNICAL GROUP LIMITED
NO. 1, Lane 17, Sec. 2, Han Shi West Road, Taichung 40151, Taiwan
www.altoproaudio.com Tel: 886-4-22313737
email: info@altoproaudio.com Fax: 886-4-22346757

All rights reserved to ALTO. All features and content might be changed without prior notice. Any photocopy, translation, or reproduction of part of this manual without written permission is forbidden. Copyright ©2009 Seikaku Group