

User's Manual

S-12

12-CHANNEL MIXING CONSOLE

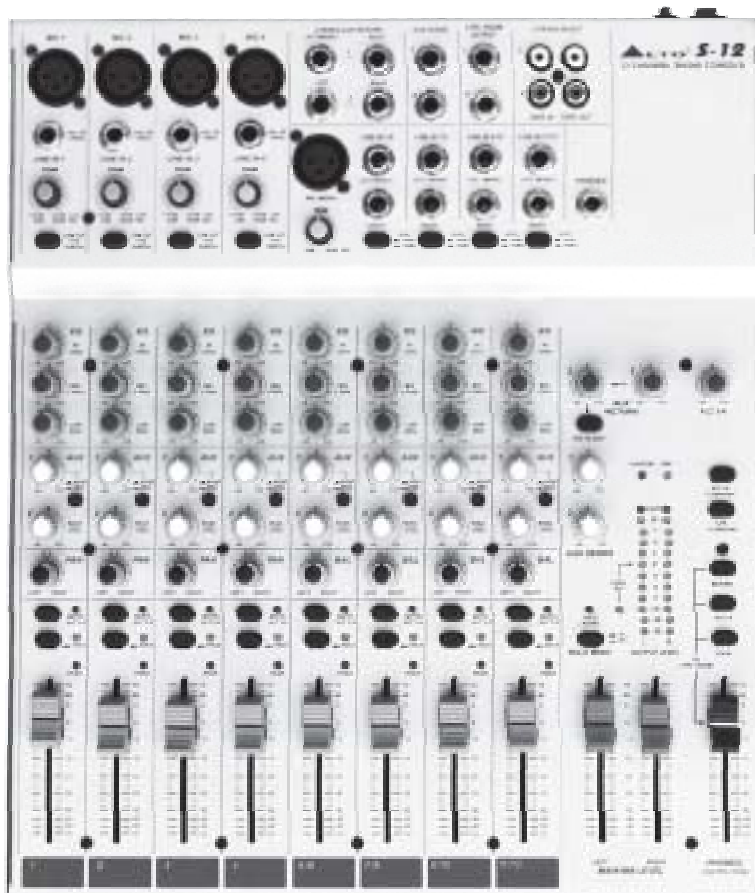

www.altoproaudio.com
Version 2.3 August 2005

— English —

SAFETY RELATED SYMBOLS



This symbol, wherever used, alerts you to the presence of un-insulated and dangerous voltages within the product enclosure. These are voltages that may be sufficient to constitute the risk of electric shock or death.



This symbol, wherever used, alerts you to important operating and maintenance instructions. Please read.



Protective Ground Terminal



AC mains (Alternating Current)



Hazardous Live Terminal

ON: Denotes the product is turned on.

OFF: Denotes the product is turned off.

WARNING

Describes precautions that should be observed to prevent the possibility of death or injury to the user.

CAUTION

Describes precautions that should be observed to prevent damage to the product.



Disposing of this product should not be placed in municipal waste and should be Separate collection.

WARNING

• Power Supply

Ensure that the mains source voltage (AC outlet) matches the voltage rating of the product. Failure to do so could result in damage to the product and possibly the user.

Unplug the product before electrical storms occur and when unused for long periods of time to reduce the risk of electric shock or fire.

• External Connection

Always use proper ready-made insulated mains cabling (power cord). Failure to do so could result in shock/death or fire. If in doubt, seek advice from a registered electrician.

• Do Not Remove Any Covers

Within the product are areas where high voltages may present. To reduce the risk of electric shock do not remove any covers unless the AC mains power cord is removed.

Covers should be removed by qualified service personnel only.

No user serviceable parts inside.

• Fuse

To prevent fire and damage to the product, use only the recommended fuse type as indicated in this manual. Do not short-circuit the fuse holder. Before replacing the fuse, make sure that the product is OFF and disconnected from the AC outlet.

• Protective Ground

Before turning the product ON, make sure that it is connected to Ground. This is to prevent the risk of electric shock.

Never cut internal or external Ground wires. Likewise, never remove Ground wiring from the Protective Ground Terminal.

• Operating Conditions

Always install in accordance with the manufacturer's instructions.

To avoid the risk of electric shock and damage, do not subject this product to any liquid/rain or moisture. Do not use this product when in close proximity to water.

Do not install this product near any direct heat source. Do not block areas of ventilation. Failure to do so could result in fire.

Keep product away from naked flames.

IMPORTANT SAFETY INSTRUCTIONS

Read these instructions

Follow all instructions

Keep these instructions. Do not discard.

Heed all warnings.

Only use attachments/accessories specified by the manufacturer.

• Power Cord and Plug

Do not tamper with the power cord or plug. These are designed for your safety.

Do not remove Ground connections!

If the plug does not fit your AC outlet seek advice from a qualified electrician.

Protect the power cord and plug from any physical stress to avoid risk of electric shock.

Do not place heavy objects on the power cord. This could cause electric shock or fire.

• Cleaning

When required, either blow off dust from the product or use a dry cloth.

Do not use any solvents such as Benzol or Alcohol. For safety, keep product clean and free from dust.

• Servicing

Refer all servicing to qualified service personnel only.

Do not perform any servicing other than those instructions contained within the User's Manual.

PREFACE

Dear Customer:

Thank you for choosing the ▲LTO S-12 12-Channel Mixing Console, which is the result of our ▲LTO AUDIO TEAM's endeavours.

For the ▲LTO AUDIO TEAM, music and audio is more than a profession, it is a passion and an obsession!

We have, in fact, been designing professional audio products for a number of years in cooperation with many of the world's major brands.

The ▲LTO line represents unparalleled analogue and digital products made by musicians, for musicians. With our design centres in Italy, the Netherlands, and the United Kingdom we provide you with world-class designs, while our software development teams continue to develop an impressive range of audio specific algorithms.

By purchasing our ▲LTO products you become the most important member of our ▲LTO AUDIO TEAM. We would like to share with you our passion for what we design and invite you to make suggestions, which will aid us in developing future products for you. We guarantee you our commitment for quality, continual research and development, and of course the best prices.

The ▲LTO S-12 is an extremely flexible, ultra-low noise 12-channel console, configured with 4 mono and 4 stereo input channels, each channel is equipped with a variety of key features including a warm, natural sounding EQ, Peak LEDs MUTE/ALT3-4, SOLO-in-place and high quality fader.

We would like to thank all the people who made the ▲LTO S-12 12-Channel Mixing Console possible, especially to our designers and ▲LTO staff. It is their passion for music and professional audio that has made it possible for us to offer you, our most important team member, our continued support.

Thank you very much

▲LTO AUDIO TEAM

TABLE OF CONTENTS

1.INTRODUCTION.....	4
2.FEATURES.....	5
3.GETTING STARTED.....	6
4.CONTROL ELEMENTS.....	7
4.1 The mono MIC/LINE channels.....	8
4.2 INPUT LEVEL setting.....	8
4.3 LOW CUT FILTER.....	8
4.4 STEREO INPUTS.....	9
4.5 +4dBu / -10dBV.....	9
4.6 PHONES.....	9
4.7 The 3 BANDS EQUALISER.....	9
4.8 AUX SEND	10
4.9 PAN.....	10
4.10 MUTE / ALT 3-4	10
4.11 SOLO	10
4.12 SOLO LED	10
4.13 PEAK.....	10
4.14 FADER.....	10
4.15 INSERT.....	11
4.16 MAIN SECTION.....	11
4.17 REAR PANEL	14
5.INSTALLATION & CONNECTION.....	15
6.FOR THE EXPERTS WHO WANT TO KNOW MORE.....	18
7.SYSTEM BLOCK DIAGRAMS.....	19
8.TECHNICAL SPECIFICATIONS.....	20
9.WARRANTY.....	21

1.INTRODUCTION

Your S-12 is a 12-channel mixer and it is one of the most popular compact mixing consoles in the world. In fact it has been sold already in terms of thousands of units worldwide. Despite its compact dimensions, great performances and sound quality are insured thanks to the specification of the components used and the building quality.

Your S-12 is packed with features that can not be found in other consoles of its size: 4 Mono (these are provided with Ultra Low Noise microphone preamplifiers and Phantom Power at +48 Volt) and 4 stereo input channels are provided, and each of them is provided with a 3 bands graphic equaliser for HI, MID and LOW controls, MUTE/ALT 3-4, SOLO-in-place and high quality fader etc..

Your S-12 is very easy to operate but we advise you to go through each Section of this Manual carefully. In this way you will get the best out of your S-12.

2. FEATURES

The S-12 12-Channel Mixing Console is designed for the professional application, and presents with the following specific features:

- Ultra-low noise 12-channel 2+2-bus mixing console
- 4 MIC input channels with gold plated XLRs and balanced Line inputs
- 4 stereo input channels with balanced TRS jacks
- 2 additional multi-functional stereo AUX Returns
- Ultra-low noise discrete MIC preamps with +48V Phantom power
- Low noise, high headroom
- Peak LEDs on each channel
- TRS and XLR outputs, Phones / Control Room output and Alt output.
- 2 Aux Sends per channel for external effects and monitoring
- 2-Track inputs assignable to Main Mix, Phones / Control Room outputs
- Mute / Alt 3-4, Solo function on each channel
- Highly accurate 12-segment Bar-graph meters
- +4dBu / -10dBV on each stereo channel
- Switchable Low Cut filter on each mono channel
- Inserts on MIC channels
- High quality faders and potentiometers

3. GETTING STARTED

- 3.1 Please check the AC Voltage available in your Country before connecting your S-12 to the AC socket.
- 3.2 Be sure that the main power switch is turned off before connecting the Mixer to the AC socket. Also, you should make sure that all Input and Output Controls are turned down. This will avoid damages to your speakers and avoid excessive noise.
- 3.3 Before turning on the S-12 you shall connect it to a power amplifier and turn-on the mixer BEFORE the power amplifier. Once you have finished your working session you shall turn the mixer off AFTER the power amplifier.
- 3.4 Before disconnecting the S-12 always turn-off the Power switch.
- 3.5 Do not use solvents to clean your S-12. A dry and clean cloth will be OK.

4. CONTROL ELEMENTS

ALTO® S-12
12-CHANNEL MIXING CONSOLE

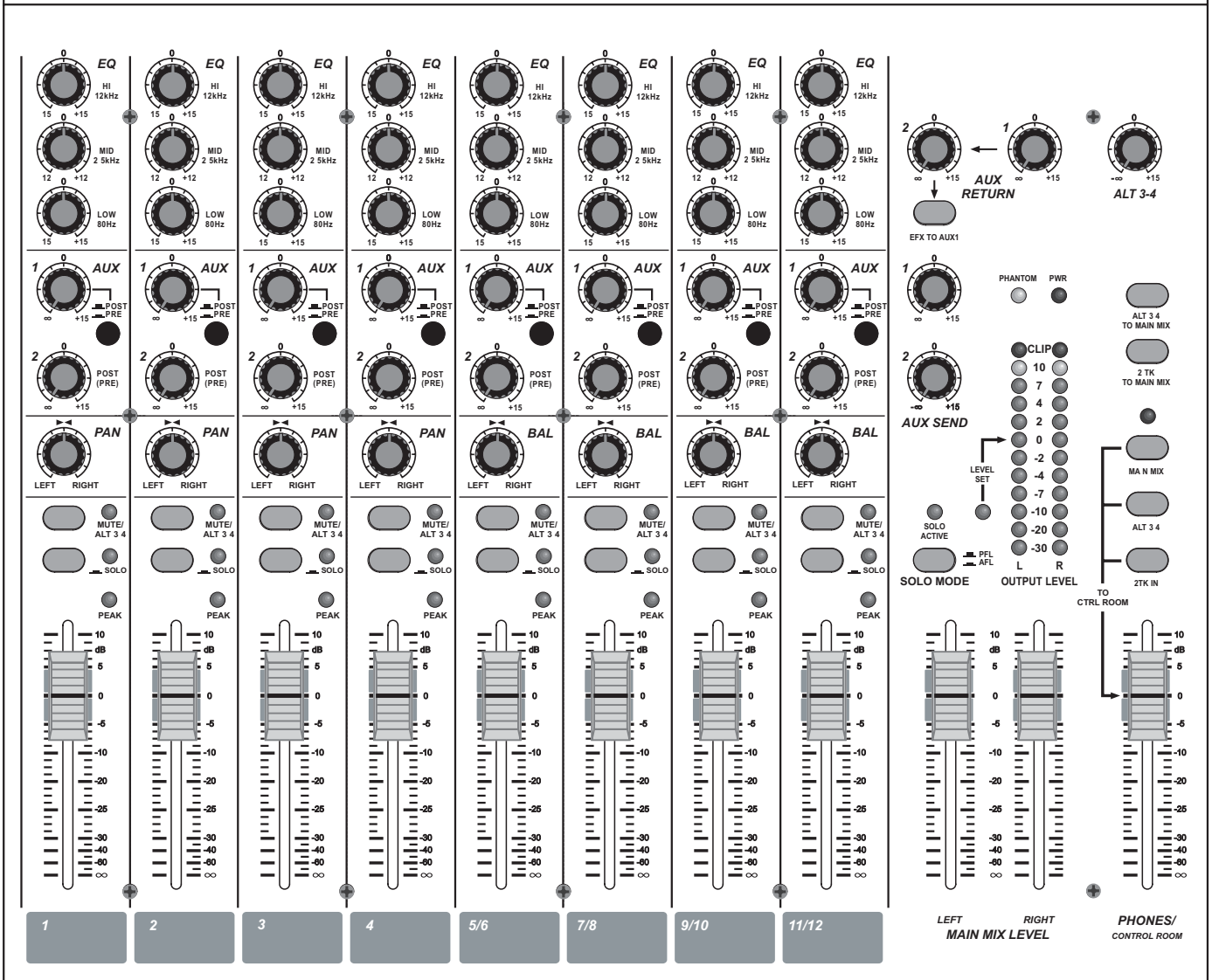
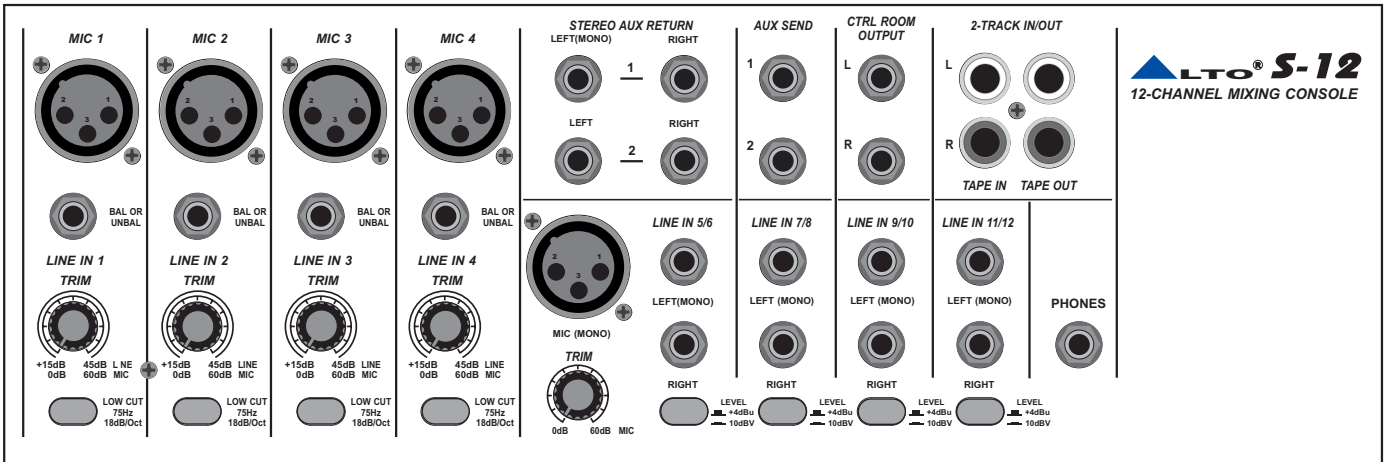

4.1 The mono MIC/LINE channels 1

These are Channel 1 through Channel 4. You can connect balanced, low impedance microphones to the XLR socket. On the 1/4" phone jack you can connect either a microphone or a line level instrument. You shall never connect an unbalanced microphone to the XLR socket if you do not want to damage both the Microphone and the Mixer.

48 Volt phantom power 2

It is available only to the XLR Mic sockets. Never plug in a microphone when phantom power is already on. Before turning phantom power on, make sure that all faders are all the way down. In this way you will protect your Stage Monitors and Main Loudspeakers.

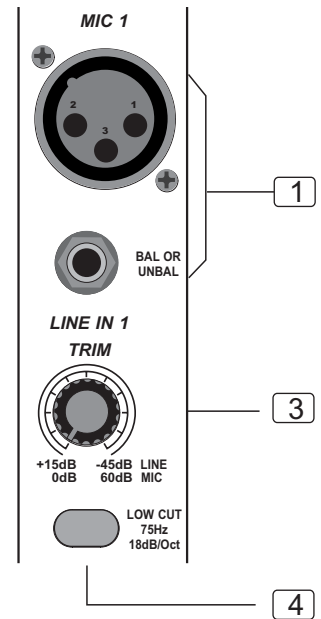

4.2 INPUT LEVEL setting 3

This Control is provided with 2 different indication rings: One is for the Microphone and the other for the Line levels. When you use a microphone you shall read the OUTSIDE ring (0-60 dB), When you use a Line level instrument you shall read the INSIDE ring (+15~-45 dB). For optimum operation you shall set this control in a way that the peak LED will blink also occasionally in order to avoid distortion on the input channel.

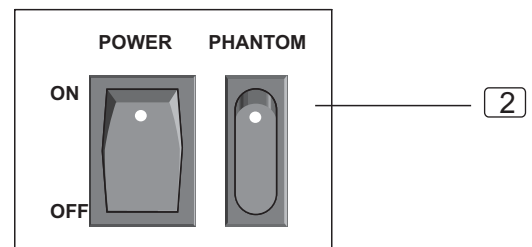

4.3 LOW-CUT FILTER 4

By pressing this button you will activate a 75 Hz low frequency filter with a slope of 18 dB per octave. You can use this function to reduce hum and stage rumble when using microphones.

4.4 STEREO INPUTS 5

These are Channel 5 through 12. They are organised in stereo pair and they are provided with 1/4" TRS phone sockets.

If you connect only the left jack, the input will operate in mono mode.

4.5 +4dBu / -10dBV 6

This switch adjusts the input sensitivity of the line inputs on the stereo channels CH 5 ~ CH 12. Engaging the switch is used to suit for "-10dBV" sound source. If you are unsure, leave the switch up.

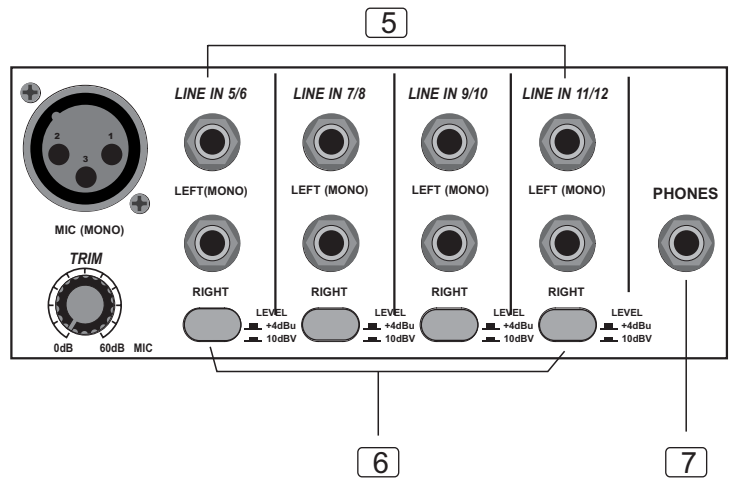

4.6 PHONES 7

The 1/4" TRS socket will send out the signal mix to a pair of headphones

4.5 The 3 BANDS EQUALISER

A 3-band equaliser is provided for all input channels with a wide range of frequency adjustment.

4.5.1 HI 8

This is the Treble control. You can use it to get rid of high frequency noises or to boost the sound of cymbals or the high harmonics of the human voice. The gain range goes from -15dB to +15dB with a center frequency of 12 kHz.

4.5.2 MID 9

This is the Midrange control. It can affect most fundamental frequencies of all musical instruments and human voice. An attentive use of this control will give you very wide panorama of sound effects. The gain range goes from -12dB to +12dB and the center frequency is 2.5 kHz.

4.5.3 LOW 10

This is the Bass control. Boost male voice or kickdrum and bass guitar. Your system will sound much bigger than what it is. The gain range goes from -15dB to +15dB and the center frequency is 80 Hz.

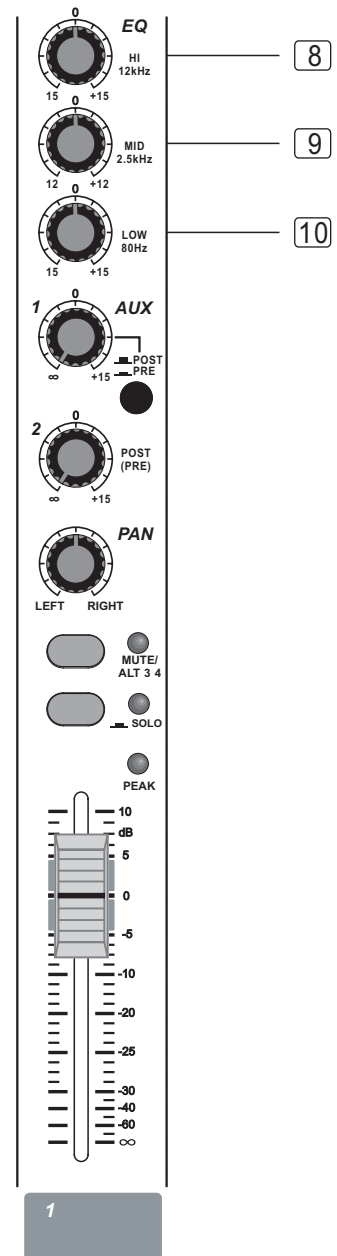

4.8 AUX SEND 11

These two controls will send the audio signal out to Auxiliary busses. AUX 1 can be configured as PRE/POST Fader via the PRE/POST switch: Up for POST Fader, the audio signal will be affected by the main Channel Fader; Down for PRE Fader, the signal is sent out before reaching the main fader. AUX 2 is configured as POST-Fader; However, AUX 2 can also be configured as PRE-Fader through any internal modification. (Please see "MODIFICATIONS" later in this Manual.)

4.9 PAN 12

This is the PANORAMA control, or balance control. You can adjust the stereo image of the signal via this Control. Keep this control in center position and your signal will be positioned in the middle of stage. Turn this control fully counterclockwise and the signal will be present only on the left speaker and vice-versa. Of course a wide number of intermediate positions is available.

4.10 MUTE / ALT 3-4 13

Each channel is equipped with the MUTE / ALT 3-4 switch. Pressing this switch is used to route the channel signal to ALT 3-4 output instead of the main mix and the LED beside MUTE/ ALT 3-4 will illuminate.

4.11 SOLO 14

Pressing this switch allows you to monitor the signals through your headphone or CONTROL ROOM, then the SOLO signal will replace other signals, and be also sent to the CONTROL ROOM, PHONES and METERS. Usually use the solo in live work to preview channels before they are let into the mix.

It is useful to set an instruments's input level and EQ, and you can also solo any channel that you want to. The SOLO switch never affects any mix other than the CONTROL ROOM mix.

4.12 SOLO LED 15

Each channel is equipped with the SOLO LED display. When the SOLO button was engaged, the LED on corresponding channel will illuminate.

4.13 PEAK 16

Inside your S-12 the audio signal is monitored in several different stages and then sent to the PEAK Led. When this Led blinks, it warns you that you are reaching signal saturation and possible distortion. The PEAK Led will blink with a level that is 6dB before actual clipping.

4.14 FADER 17

This Fader will adjust the overall level of this channel and set the amount of signal sent to the Main output.

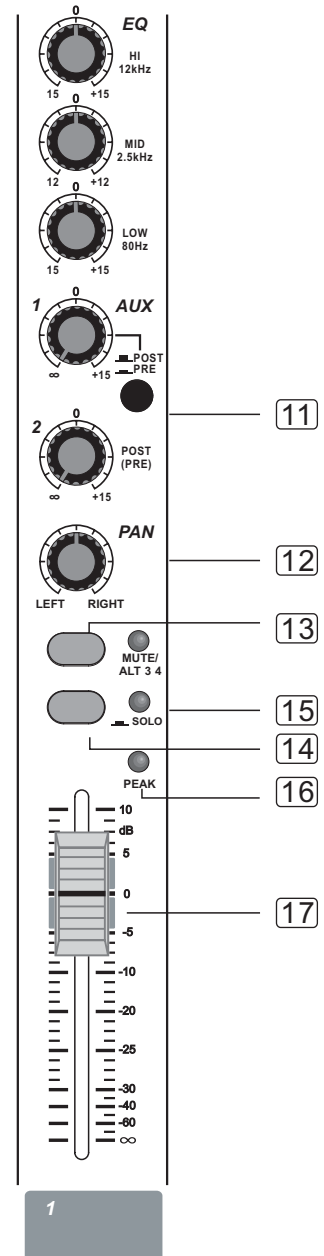

4.15 INSERT 18

Insert points are provided for the Mono Mic Channels. When you insert a jack in the insert socket, the signal will be taken out after the Input Gain Control (Trim), sent to an external processor such a compressor-limiter, and returned into the channel strip immediately before the EQ section. Of course, these jacks used must be stereo (Tip Send/Ring Return).

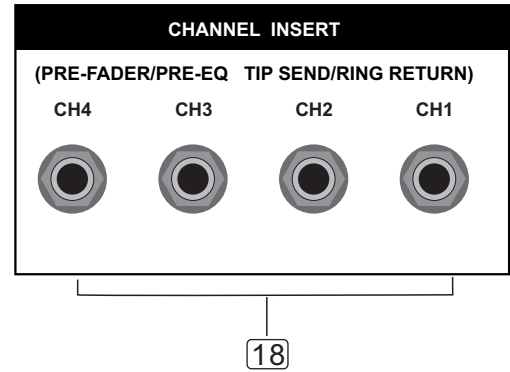

4.16 MAIN SECTION

- STEREO AUX RETURN 19

Use these stereo 1/4" phone socket to return the sound of an effect unit or sound processor to the Main Mix.

Alternatively you can use them as an extra auxiliary input.

- AUX SEND 1 & 2 20

This 1/4" phone socket is used to send out the signal from the AUX Bus to external devices such as effects and sound processors.

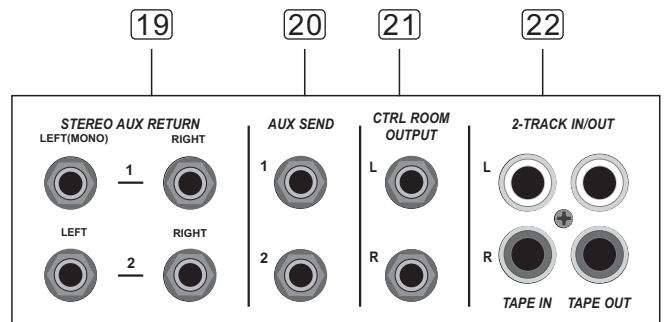

- CONTROL ROOM OUTPUT 21

These two unbalanced TRS jacks should be connected to the input of your control room amplifier.

- 2-TRACK IN / OUT 22

Input

Use the Tape input if you wish to listen to your Mix from a Taper Recorder or DAT, You can assign the signal coming form the Taper Recorder either to a pair of studio monitor using the Control Room assignment on the front panel or you can also send the signal directly to the Main Mix.

Output

These 1/4" TRS sockets will route the main mix into a tape recorder.

- . AUX SEND 23

The both switches are used to determine the master AUX SEND levels. The adjustable range is from $-\infty$ to +15dB.

When the effect unit connected to mixer has no input gain control, you can get a further +15dB gain available from these AUX SEND outputs.

- . AUX RETURN 24

The Auxiliary Returns 1 and 2 are in fact two additional stereo Line inputs. AUX RETURN 1 is configured to be assigned permanently to the Main Mix. (It operates in Mono Mode if you connect only the left jack).

The EFX TO AUX1 button is used to switch the signal from AUX RETURN 2 between MAIN MIX and AUX SEND 1.

If a signal is routed to AUX RETURN 1 and no signal is connected to AUX RETURN 2, depressing the EFX TO AUX 1 will route the signal to AUX SEND 1, which level will be controlled by AUX RETURN 2.

Without doubt, this feature will be very useful to you.

- . MAIN MIX LEVEL 25

These faders set the amount of signal sent either to the Main Out socket or to the Tape Output.

- . LED METER 26

This stereo 12 segments Led Meter will indicate the level of the overall output signal.

- . SOLO MODE 27

This button provides two modes: up for PFL (Pre-Fader-Listen) mode, down for AFL (After-Fader-Listen) mode. Engage the button, the output signal of soloed channel will follow the TRIM, EQ, FADER and PAN/BAL control, and the SOLO ACTIVE LED illuminates.

Release the button to enter into PFL mode, the output signal of soloed channel is unaffected by the PAN/BAL and FADER control.

Please note that the SOLO function can never affect the mix at main recording output, and also can't be affected by channel's MUTE/ALT 3-4 switch.

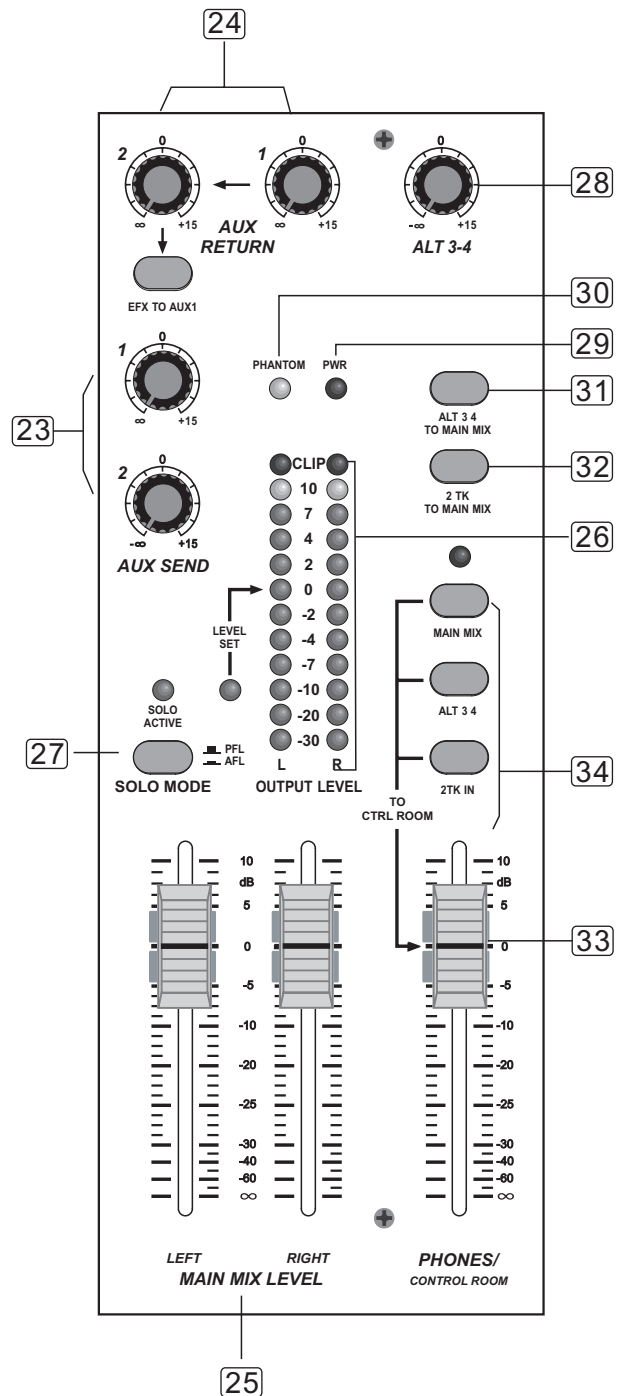

- ALT 3-4 **28**

This switch is used to adjust the level of the ALT output, and the adjustable range is from $-\infty$ to +15dB. This is another way to offer you an extra independent stereo submix with its own level adjustment knob.

- POWER **29**

This LED indicates when the Power is on in your S-12.

- PHANTOM **30**

This LED indicates when the Phantom Power is switched on.

- ALT 3-4 TO MAIN MIX **31**

Engaging this switch allows you to combine the ALT 3-4 output with the MAIN MIX, and feeds ALT 3 - 4 signals into MAIN L / R output.

- 2 TK TO MAIN MIX **32**

Engaging this switch allows you to combine the 2 TRACK Output with the MAIN MIX, in other words, feeds the 2 TRACK IN signals into MAIN L / R output.

- PHONES / CONTROL ROOM **33**

This Control sets the amount of signal sent to the Control Room and headphone.

- CONTROL ROOM SOURCE **34**

You can choose to monitor any combination of MAIN MIX, ALT 3-4 and 2 TK IN via these MATRIX switches. The ALT 3-4 is the additional stereo mix bus; 2 TK IN is the stereo signal coming from the TAPE IN RCA jacks.

These stereo signals will be delivered to the PHONES / CONTROL ROOM and METERS display via engaging these switches. If no switches engaged, there will be no signal at these outputs.

Note: When the channel's SOLO switch was engaged, then, the SOLO signal will replace other signals, and also be sent to the CONTROL ROOM, PHONES and METERS.

4.17 REAR PANEL

- AC INLET & FUSE HOLDER 35

Use it to connect your S-12 to the Main AC with the supplied AC cord. Please check the Voltage available in your Country and how the Voltage for your S-12 is configured before attempting to connect your S-12 to the Main AC.

- POWER 36

This switch is used to turn the Main Power ON and OFF.

- PHANTOM 2

This switch will apply +48 Volt Phantom Power only to the 5 XLR microphone inputs. Never connect microphones when the Phantom Power is on already.

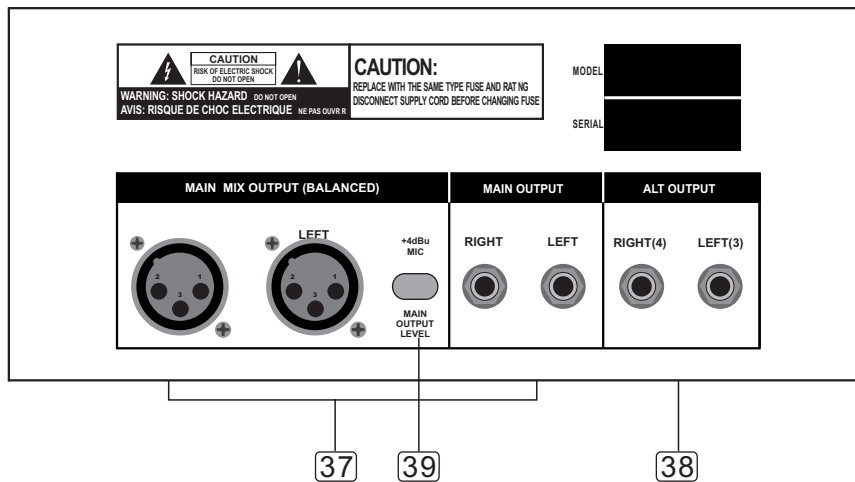
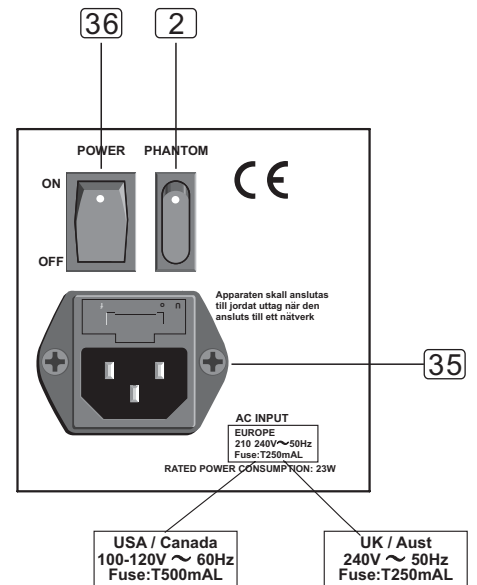

- MAIN MIX OUTPUT 37

This stereo output is supplied both with XLR and 1/4" jack socket and it is controlled by the Main Mix Level on the front panel. It will send the audio signal to an amplifier. The output level can be varied from $-\infty$ to +10dB.

- ALT OUTPUT 38

These 1/4" sockets are unbalanced outputs. They are capable of delivering +22dBu into the load. Level to the ALT OUTPUT is adjusted by ALT 3-4 rotary knob on the front panel.

- MAIN OUTPUT LEVEL 39

When depress the switch, the output level from MAIN MIX OUTPUT will be reduced 30dB.

5. INSTALLATION & CONNECTION

Ok, you have got to this point you are now in the position to successfully operate your S-12. However, we advise you to read carefully the following section to be the real Master of your own Mix. Not paying attention enough to the Input signal level, to the routing of the signal and the assignment of the signal will result in unwanted distortion, a corrupted signal or no sound at all. So you should follow this procedure for every single channel:

- Turn down all Input and Output Gain Controls.
- Connect phantom powered microphones before switching on the +48Volt Phantom Power switch.
- If you have a power amplifier connected to your S-12 set the Level of the amplifier at no more than 70%.
- Now, set the CONTROL ROOM/PHONES level at no more than 50%. In this way you will be able to hear later what you are doing connecting a pair of headphones or a pair of powered studio monitor speakers.
- Position EQ controls on middle position.
- Position panoramic (PAN) control on center position.
- With a headphone or studio monitor speakers connected apply a Line Level input signal so that the PEAK Led does not light up.
- At this point increase the input gain so that the PEAK led will blink occasionally. In this way you will maintain good headroom and ideal dynamic range.
- Now connect a microphone and ask the singer to sing loud into the microphone. Turn slowly the Gain Control clockwise and have the PEAK Led blink only occasionally.
- Now repeat the same sequence for all input channels. The Main Led Meter could move up into the red section. In this case you can adjust the overall output level through the MAIN MIX control.

B. Wiring Configuration

You can connect unbalanced equipment to balanced inputs and outputs. Simply follow these schematics.

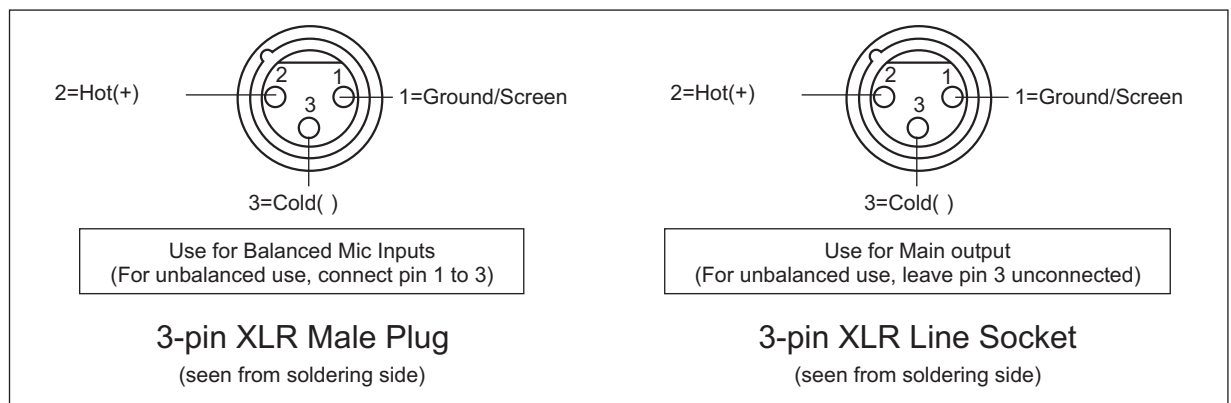
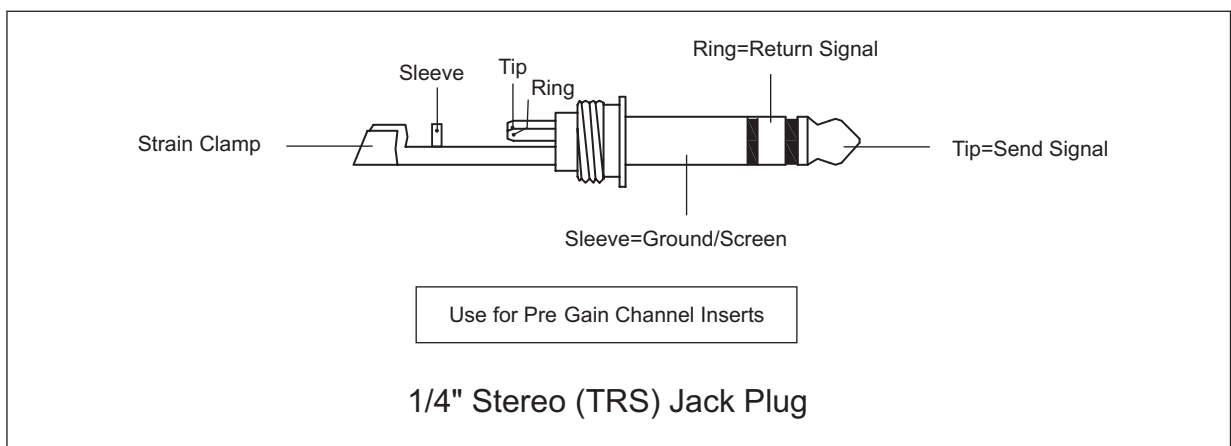
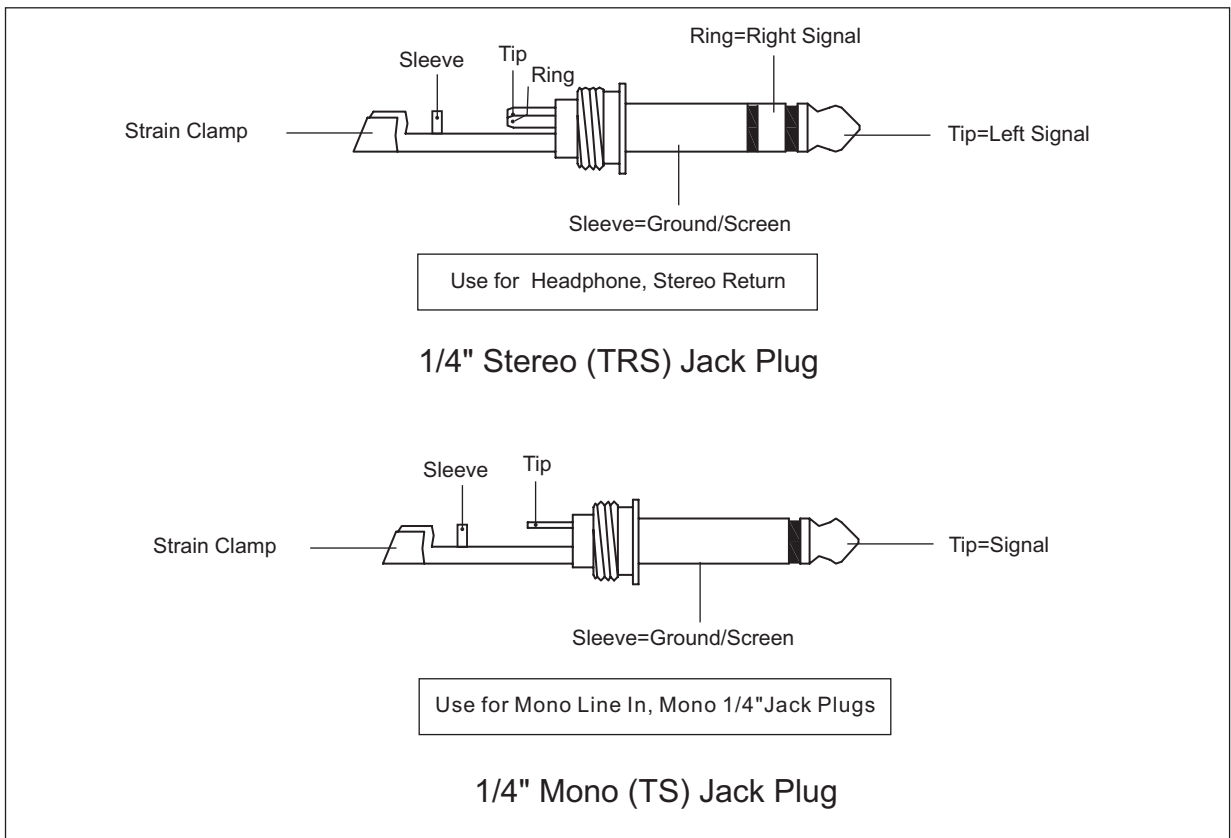

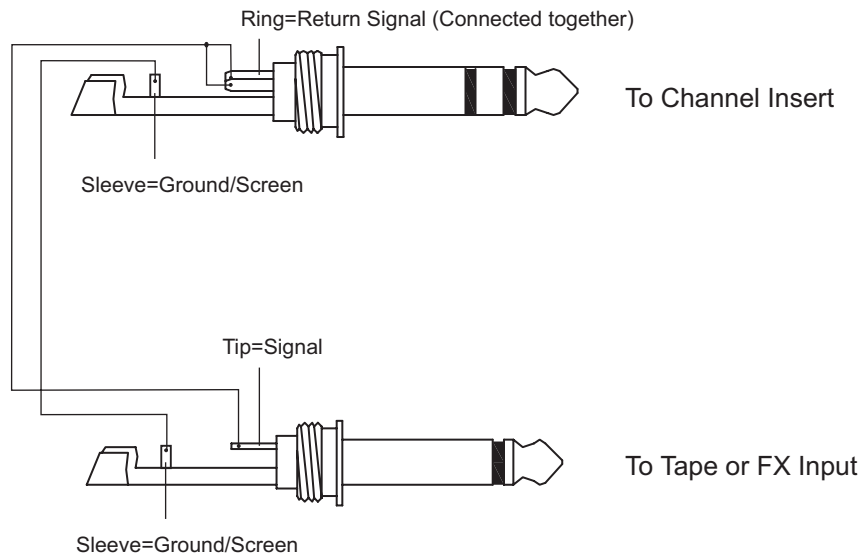

'Tapped' Connection Direct Output Lead

(Enables the Insert to be used as a Direct Output while maintaining the channel signal flow)

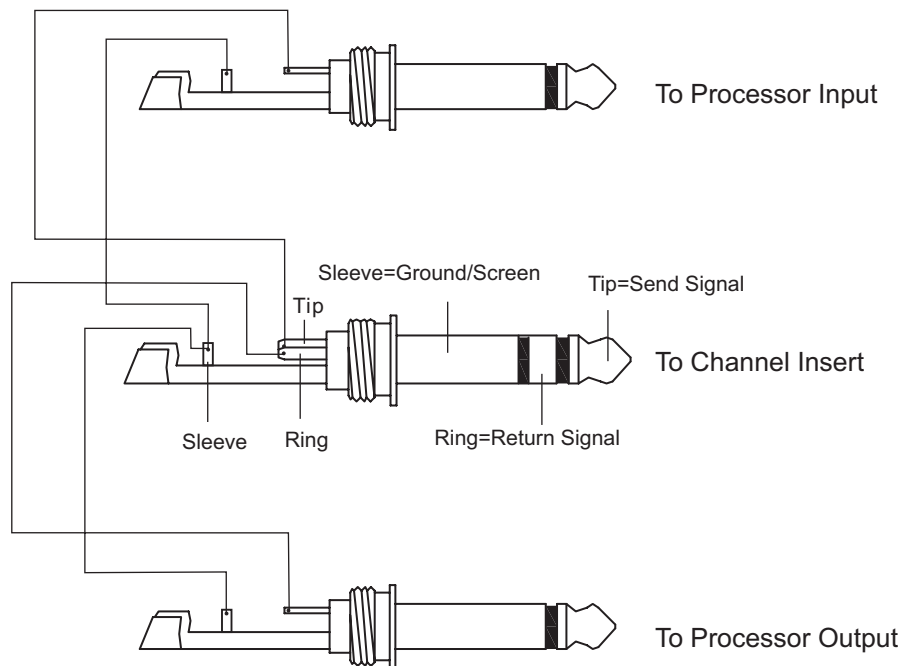

Y-Stereo lead for insert Connection

(To be used when the processor does not employ a single jack connection for the In/Out Connections)

6. FOR THE EXPERTS WHO WANT TO KNOW MORE

As we have told you previously in this Manual, the Aux Send 2 Control both on Mono and stereo channels is factory wired as POST-FADER. If you have some skill in electronic components soldering you can modify this setting and have all your AUX sends configured as PRE-FADER.

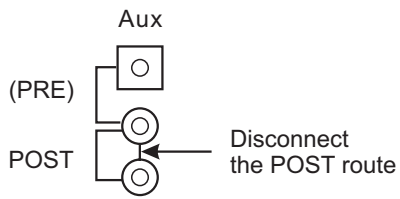

Before

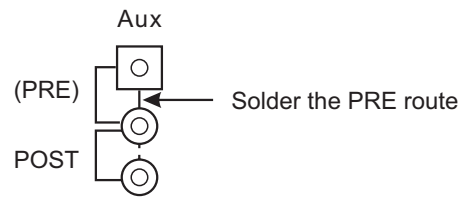

After

Modification on mono and stereo channels

7. SYSTEM BLOCK DIAGRAMS

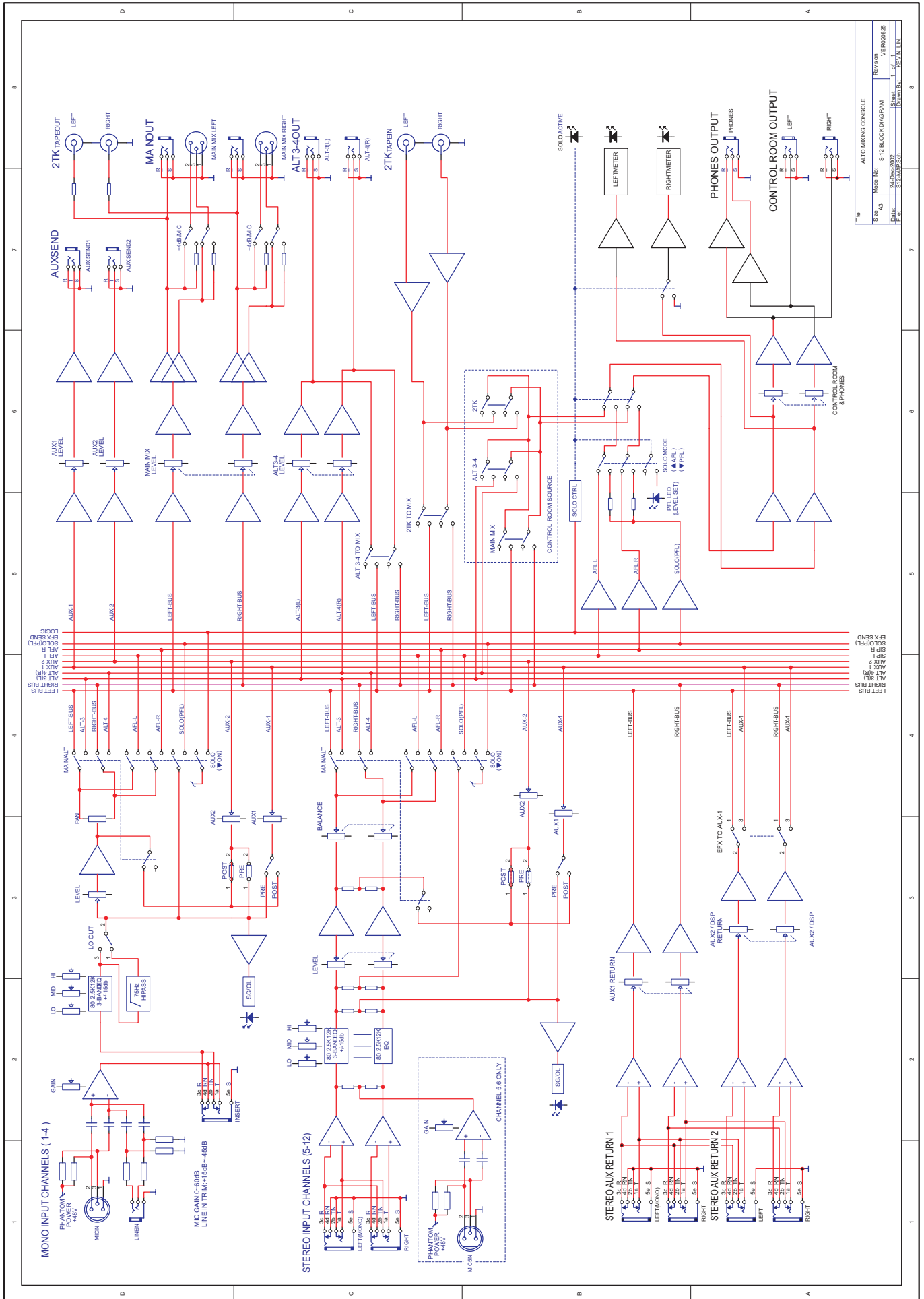

T 8		AUTO MIXING CONSOLE	
9	10	11	12
13	14	15	16
17	18	19	20
21	22	23	24
25	26	27	28
29	30	31	32
33	34	35	36
37	38	39	40
41	42	43	44
45	46	47	48
49	50	51	52
53	54	55	56
57	58	59	60
61	62	63	64
65	66	67	68
69	70	71	72
73	74	75	76
77	78	79	80
81	82	83	84
85	86	87	88
89	90	91	92
93	94	95	96
97	98	99	100

8. TECHNICAL SPECIFICATIONS

Mono input channels		
	Microphone input	electronically balanced, discrete input configuration
	Frequency response	10Hz to 55kHz, +/-3dB
	Distortion (THD&N)	0.005% at +4dBu, 1kHz
	Gain range	0dB to 60dB(MIC),
	SNR (Signal Noise Rated)	115dB
	Line input	electronically balanced
	Frequency response	10Hz to 55kHz, +/-3dB
	Distortion (THD&N)	0.005% at +4dBu, 1kHz
	Sensitivity range	+15dBu to -45dBu
Stereo input channels		
	Line input	Balanced
	Frequency response	10Hz to 55kHz, +/-3dB
	Distortion (THD&N)	0.005% at +4dBu, 1kHz
Impedances		
	Microphone input	1.4Kohm.
	Channel Insert return	2.5Kohm.
	All other inputs	10Kohm or greater.
	Tape out	1Kohm.
	All other output	120ohm.
Equalization		
	Hi shelving	+/-15dB @12kHz
	Mid bell	+/-12dB @2.5kHz
	Low shelving	+/-15dB @80Hz
	Low Cut filter	75Hz, 18dB/oct.
Main Mix Section		
	Noise (Bus noise)	Fader 0 dB, channels muted:-100.0dBr (ref.:+4dBu) Fader 0dB, all input channels assigned and set to UNITY gain:-90dBr (ref.:+4dBu)
	Max output	+22dBu balanced XLR, +22dBu unbalanced, 1/4" jacks
	AUX Return gain range	-∞ to +15dB
	AUX Sends max out	+22dBu
Power supply		
	Main voltage	USA/Canada100-120V~, 60Hz Europe210-240V~, 50Hz U.K./Australia240V~, 50Hz
	Power Consumption	23watts
	Fuse	100-120V~ : T500mAL 210-240V~ : T250mAL
	Main connection	Standard IEC receptacle
Physical		
	Dimension (WXDXH)	300mmX355mmX28/80mm (11.8"x14.0"x0.8"/3.1")
	Net weight	4.04Kg (8.908lb)

9. WARRANTY

1. WARRANTY REGISTRATION CARD

To obtain Warranty Service, the buyer should first fill out and return the enclosed Warranty Registration Card within 10 days of the Purchase Date.

All the information presented in this Warranty Registration Card gives the manufacturer a better understanding of the sales status, so as to purport a more effective and efficient after-sales warranty service.

Please fill out all the information carefully and genuinely, miswriting or absence of this card will void your warranty service.

2. RETURN NOTICE

2.1 In case of return for any warranty service, please make sure that the product is well packed in its original shipping carton, and it can protect your unit from any other extra damage.

2.2 Please provide a copy of your sales receipt or other proof of purchase with the returned machine, and give detail information about your return address and contact telephone number.

2.3 A brief description of the defect will be appreciated.

2.4 Please prepay all the costs involved in the return shipping, handling and insurance.

3. TERMS AND CONDITIONS

3.1 ▲LTO warrants that this product will be free from any defects in materials and/or workmanship for a period of 1 year from the purchase date if you have completed the Warranty Registration Card in time.

3.2 The warranty service is only available to the original consumer, who purchased this product directly from the retail dealer, and it can not be transferred.

3.3 During the warranty service, ▲LTO may repair or replace this product at its own option at no charge to you for parts or for labor in accordance with the right side of this limited warranty.

3.4 This warranty does not apply to the damages to this product that occurred as the following conditions:

- Instead of operating in accordance with the user's manual thoroughly, any abuse or misuse of this product.
- Normal tear and wear.
- The product has been altered or modified in any way.
- Damage which may have been caused either directly or indirectly by another product / force / etc.
- Abnormal service or repairing by anyone other than the qualified personnel or technician.

And in such cases, all the expenses will be charged to the buyer.

3.5 In no event shall ▲LTO be liable for any incidental or consequential damages. Some states do not allow the exclusion or limitation of incidental or consequential damages, so the above exclusion or limitation may not apply to you.

3.6 This warranty gives you the specific rights, and these rights are compatible with the state laws, you may also have other statutory rights that may vary from state to state.

SEIKAKU TECHNICAL GROUP LIMITED
SEKAKU ELECTRON INDUSTRY CO., LTD.
No. 1, Lane 17, Sec. 2, Han Shi West Road, Taichung 40151, Taiwan
<http://www.altoproaudio.com> Tel: 886-4-22313737
email: alto@altoproaudio.com Fax: 886-4-22346757

All rights reserved to ALTO. All features and content might be changed without prior notice. Any photocopy, translation, or reproduction of part of this manual without written permission is forbidden. Copyright © 2005 SEIKAKU GROUP