

---

# Owner's Manual

---

## Anniversary Edition Reference Preamplifier

**audio research**  
HIGH DEFINITION®

3900 ANNAPOLIS LANE NORTH / PLYMOUTH, MINNESOTA 55447-5447 / PHONE: 763-577-9700 FAX: 763-577-0323

[www.audioresearch.com](http://www.audioresearch.com)

---

# Contents

---

## Anniversary Edition Reference Preamplifier

	Page No.
Preface . . . . .	1
Warnings . . . . .	1
Packaging . . . . .	1
Descriptions of Controls . . . . .	1, 2, 3
Connections . . . . .	3
Installation Instructions . . . . .	3
Operating Procedure . . . . .	3, 4
Troubleshooting . . . . .	4
Servicing . . . . .	4
Cleaning . . . . .	4
Disposal and Recycling Guidelines . . . . .	4
Warranty Terms and Conditions . . . . .	5
Specifications . . . . .	5

---

# Anniversary Edition Reference Preamplifier

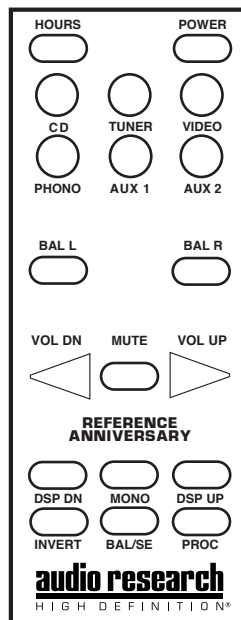
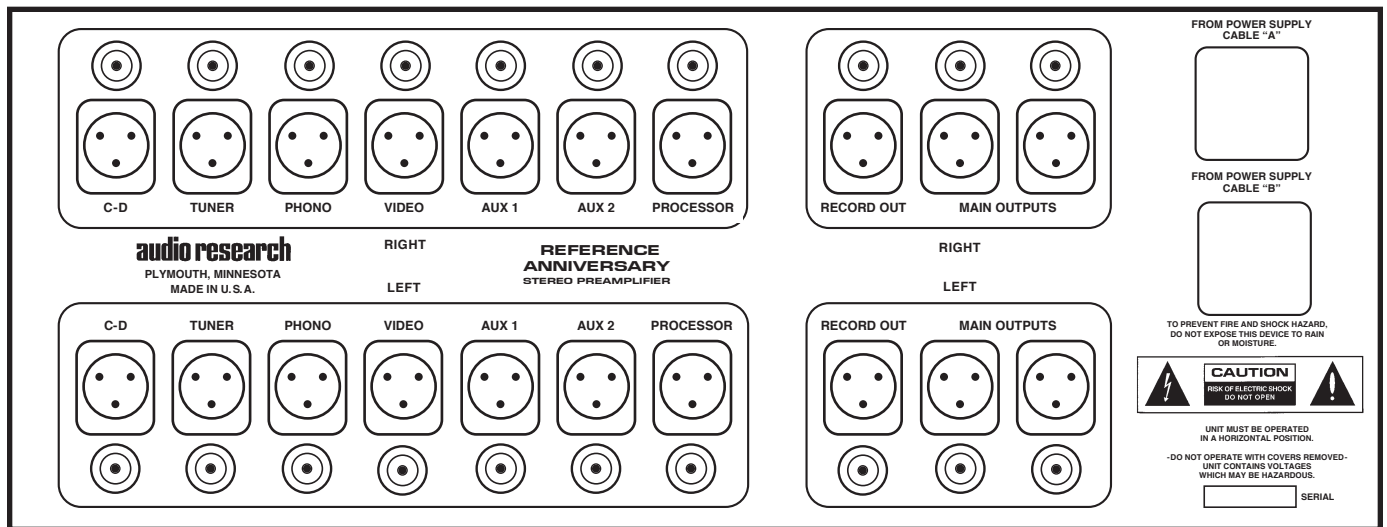
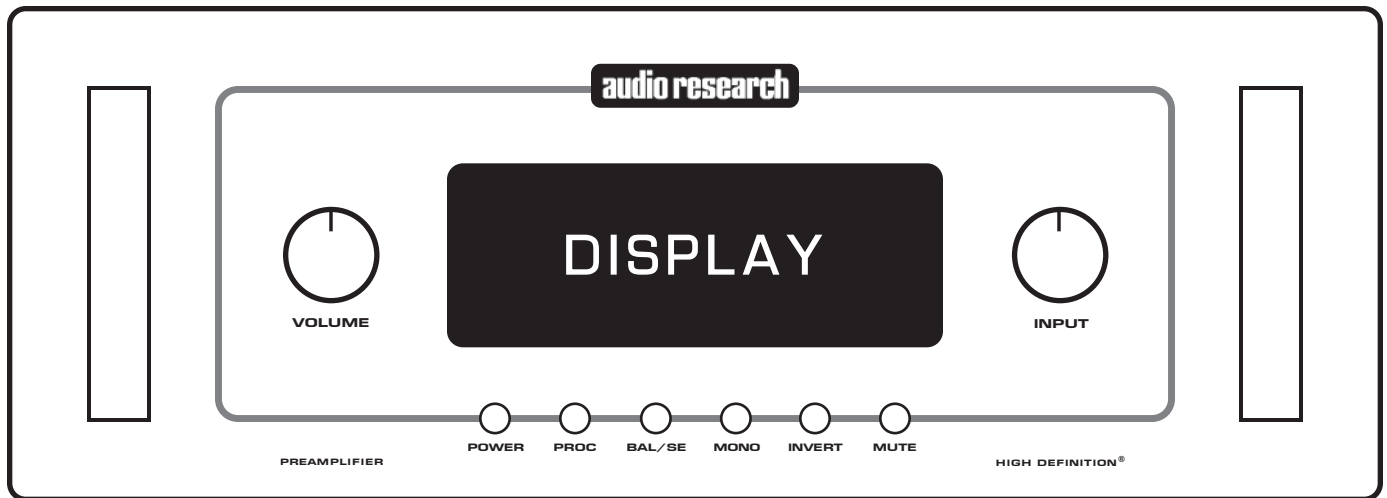

# Anniversary Edition Reference Preamplifier

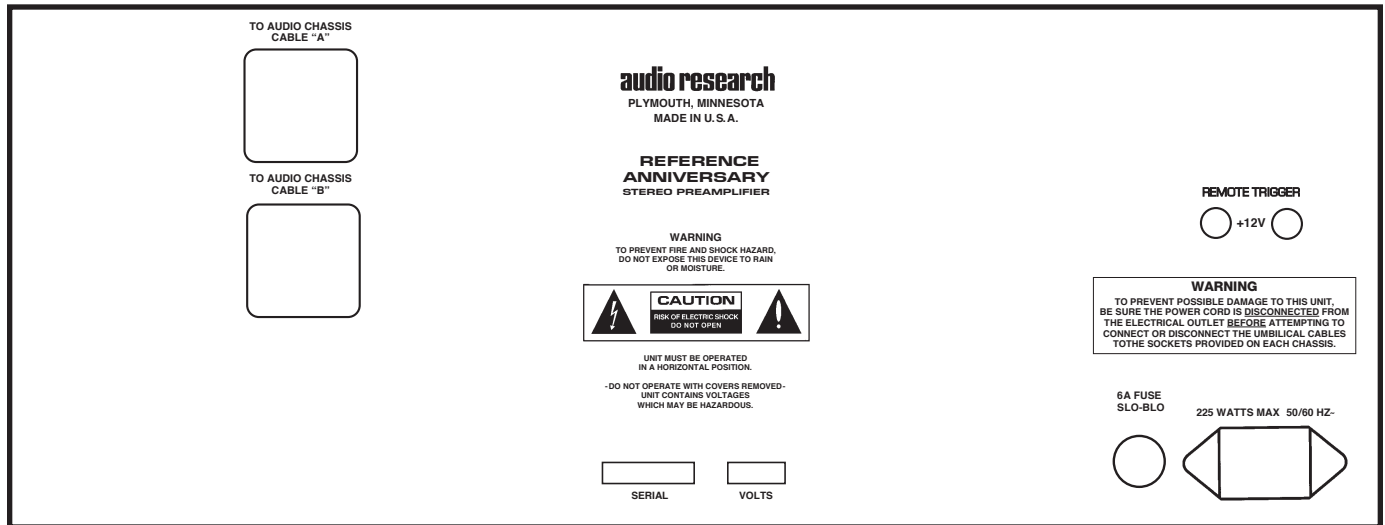
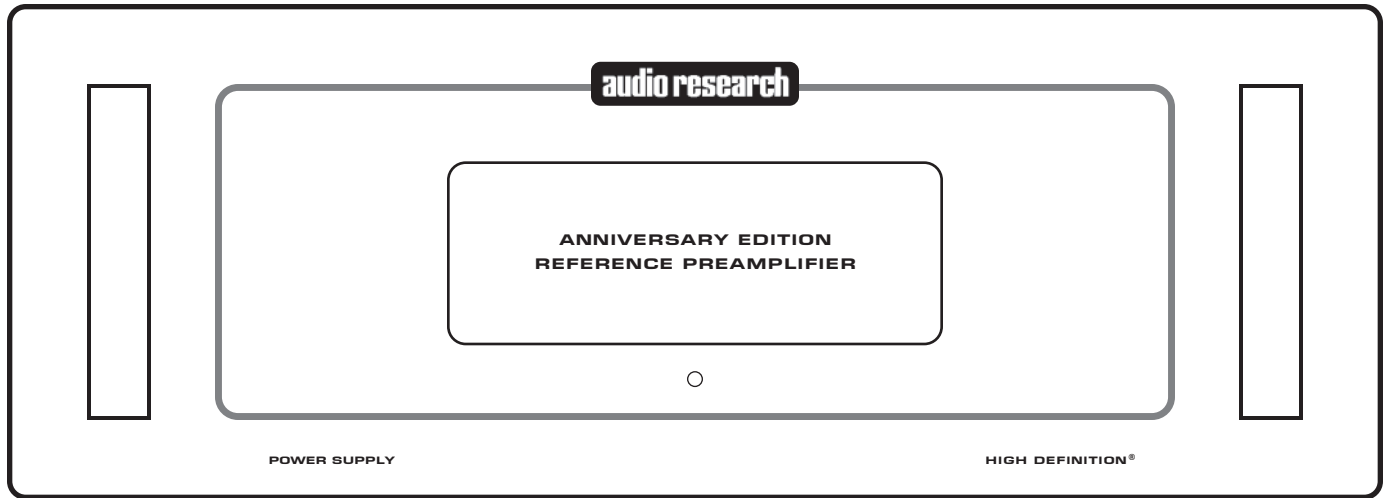

# Anniversary Edition Reference Preamplifier

## Preface

Please take time to carefully read and understand the following instructions before you install or attempt to operate your Audio Research A. E. Ref stereo preamplifier. Becoming familiar with the product and its correct operating procedures will help assure you of maximum musical enjoyment and reliable operation. The effort you invest now will be well rewarded in the years ahead.

## Warnings

**1. TO PREVENT POSSIBLE DAMAGE TO THIS UNIT, BE SURE THE POWER CORD IS DISCONNECTED FROM THE ELECTRICAL OUTLET BEFORE ATTEMPTING TO CONNECT OR DISCONNECT THE UMBILICAL CABLES TO THE SOCKETS PROVIDED ON EACH CHASSIS.**

2. To prevent fire or shock hazard, do not expose this product to rain or moisture.

3. This unit operates on voltages which can cause serious injury or death. Do not operate with covers removed. Any necessary servicing should be carried out by your authorized Audio Research dealer or other qualified electronics technician.

4. The power cord on this unit is safety-tested and is equipped with a proper grounding plug. If used normally, it will provide a safe earth ground connection of the chassis. Defeat of the grounding plug or replacement of the plug or power cord, or any unauthorized modification of the active circuitry or controls of this unit, automatically voids warranty coverage, and could cause injury or death.

**DO NOT ATTEMPT TO OPERATE THIS EQUIPMENT BEFORE INSTALLING THE VACUUM TUBES IN THEIR PROPER SOCKETS IN BOTH CHASSIS.**

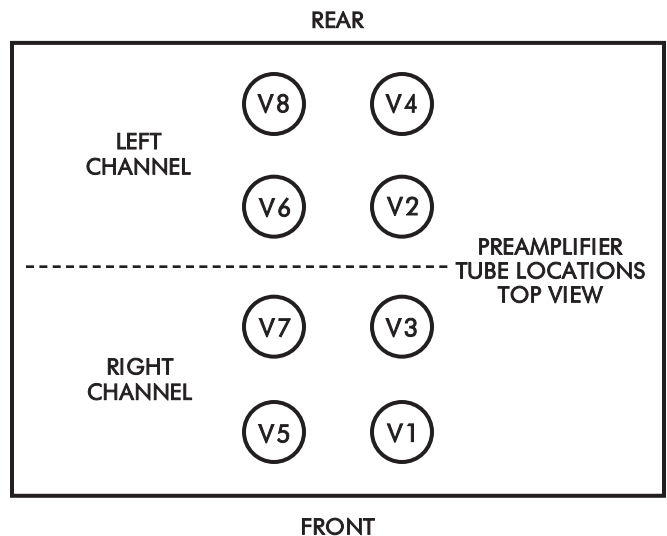
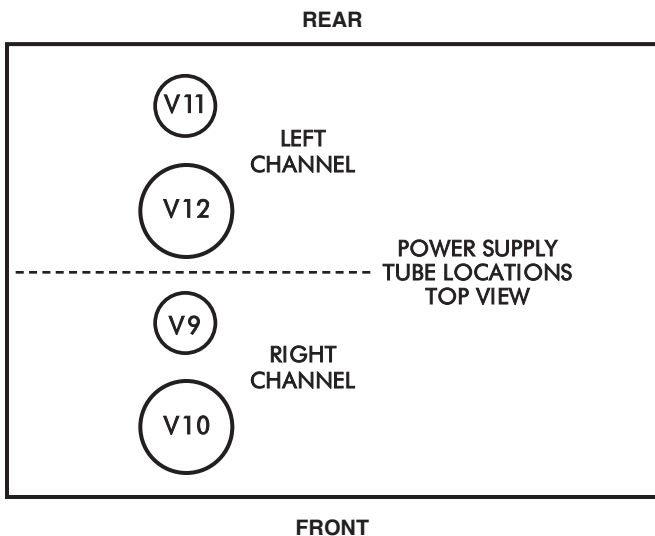

5. For safe operation and protection against fire hazard, replace fuses only with those of the same type and rating as those supplied with this unit.

## Packaging

Save all packaging accompanying this product. You have purchased a precision electronic instrument, and it should be properly cartoned any time shipment becomes necessary. It is very possible that this unit could be damaged during shipment if repackaged in cartoning other than that designed for it. The original packaging materials help protect your investment from unnecessary damage, delay and added expense whenever shipment of this unit is required.

Note that your A. E. Ref has been shipped with the vacuum tubes installed in protective foam blocks under the top covers. Two spare 6H30 tubes are included in a separate foam block in the audio control chassis. With the A. E. Ref unplugged, use a phillips-head screwdriver to loosen the fastening screws, remove the top covers and set aside. Install the numbered tubes in their respective sockets in both chassis, refasten the top covers and store the foam blocks with your cartons.

## Description of Controls

### Front Panel Rotary Controls

The A. E. Ref has two microprocessor-driven rotary controls.

The rotary control on the left adjusts Volume (output level) up or down for both L and R channels. Volume control is also selectable via Vol UP and Vol DN buttons on the remote control. Volume adjustment is indicated in the display window by both a bar graph with marker and by numeric digits on 0-103 scale.

---

# Anniversary Edition Reference Preamplifier

---

Do not turn up volume beyond normal listening levels when "Mute" is engaged to avoid unexpected or possibly damaging sound levels. Reduce volume level whenever changing input sources, even when muted.

The rotary control on the right selects any of six input sources connected to the preamplifier: CD, Tuner, Phono, Video, Aux 1 and Aux 2. Each of these sources may also be selected via direct access buttons on the remote control. The selected source is indicated in the display window.

## Front Panel and Remote Control Buttons

**POWER ON/OFF:** Supplies power from A.C. wall outlet to preamplifier; indicated by active display window. Function also on remote control.

For approximately 40 seconds after start up, "Anniversary Edition Reference Preamplifier 1970-2010" appears in the display window until the automatic muting cycle is completed. This also occurs in the event of a brief power interruption. Upon completing the cycle, the preamplifier will remain muted until normal operation is selected by pressing the Mute button.

**MUTE:** When activated, electrically mutes all output of the preamplifier; indicated by "MUTE ON" in display window. This control should be activated before switching inputs, changing connections or shutting down your audio system to help protect your amplifier and speakers from unexpected signal pulses. When deactivated, "MUTE ON" disappears from the display window allowing normal operation. Function also on remote control.

The A. E. Ref also has automatic muting to help protect system components during A.C. power interruptions or low line voltage. When there is low line voltage the front panel display will read "LOW LINE MUTE" until adequate voltage is restored, at which time the 40-second auto mute cycle begins. If there is a momentary power interruption the 40-second auto mute cycle begins.

Note that automatic muting is only designed to protect against power line interruptions or severe voltage drop. It will not mute in the event of subsonic transmissions from a faulty input source, amplifier failure or speaker malfunction.

**PROCESSOR (PROC):** May be selected by button on front panel or on remote control. Selects external A-V (home theater) processor as input source and controller of volume level for L and R channels. The A. E. Ref provides Unity Gain when this input is selected.

When engaged, "PROC" will appear in the display, and the numerical volume setting will read "NA" (for "Not Applicable") because gain is fixed and not adjustable. The preamplifier will also mute the input after "PROC" is engaged.

**WARNING:** Before unmuting the "PROC" input, be sure to turn the volume down on the home-theater processor. Never connect a source with a fixed level output (DVD player, tuner, CD, etc.) to the PROC input or the amplifier(s) and speaker system could be damaged when the A. E. Ref is unmuted.

**VOLUME UP/DOWN:** Using rotary control on front panel or VOL UP/VOL DN buttons on remote, increases/decreases overall volume level of both channels equally for whichever input has been selected. Caution: Do not turn up volume beyond normal listening levels when "Mute" is engaged to avoid unexpected or possibly damaging sound levels. It is a good idea to reduce volume level whenever changing program sources, even when muted.

**CAUTION:** Do not unmute the A. E. Ref or adjust the volume level during the 40-second auto mute warm-up cycle; you cannot see the mute/unmute status or volume setting on the display until it appears after completion of the auto mute cycle.

**BAL/SE:** Select as appropriate for each input. For source components having balanced (XLR) connections to the A. E. Ref, select BAL. For single-ended (RCA) sources, select SE. Once selected for an input source, the setting is memorized.

**INVERT:** Inverts absolute phase of the output signal.

**MONO:** Sums L and R input for mono output from any source selected.

## Remote Control-Only Functions

**DISPLAY DOWN/DISPLAY UP [DSP DN/DSP UP]:** Decreases/increases display intensity, offering six levels of brightness and display "off". If display "off" is selected, a small segment of pixels remains illuminated in the center of the display window as a reminder the unit is turned on. In display "off" mode the display will illuminate for ten seconds when any button (except Power on/off) is selected, allowing for control function navigation.

**BALANCE (BAL L/BAL R):** Adjusts balance to left or right. Adjustment appears in display window as movable marker on bar graph. Useful for compensating for uneven speaker placement or imbalanced output from a phono cartridge.

---

# Anniversary Edition Reference Preamplifier

---

**HOURS:** When pressed, displays number of operating hours vacuum tubes have been in service. **WARNING:** after replacing tubes, this function should be reset to "0" by a qualified technician. The button labeled "Hours Reset" is located on upper right corner of circuit board directly behind display window. The preamplifier must be "on" to reset function—the service technician must be careful to avoid any contact with other circuit components during reset operation. Contact Audio Research customer service (763-577-9700) for information regarding this procedure.

## Connections

**CONNECTING THE POWER SUPPLY CABLES:** **WARNING: TO PREVENT POSSIBLE DAMAGE TO THIS UNIT, BE SURE THE POWER CORD IS DISCONNECTED FROM THE ELECTRICAL OUTLET BEFORE ATTEMPTING TO CONNECT OR DISCONNECT THE UMBILICAL CABLES TO THE SOCKETS PROVIDED ON EACH CHASSIS.** There are dual mono power supply connecting cables supplied with this unit. They are fitted with locking collars on each end. Observe male to female connectors at each of the four connecting points on the two chassis, and slowly and completely mate each set of connectors to one another. Slowly rotate the locking collar at each chassis connection until you feel the locking detent snap, seating each connector firmly. This unit will not operate until both cables are firmly connected between the two chassis. Plug power cord in last.

**INPUT CONNECTORS:** The A. E. Ref provides seven pairs of BAL/SE input connectors: CD, Tuner, Phono, Video, Aux 1, Aux 2 and Processor. The BAL/SE selector button (on front panel and on remote) should be selected to match the type of connection used (BAL or SE) on each input.

Connect either the BAL or SE connectors for each input. Never connect the BAL and SE connectors simultaneously for each input.

**OUTPUT CONNECTORS:** Two pairs of BAL/SE main outputs are provided.

**RECORD OUTPUT:** The BAL/SE tape outputs should be connected to your recorder's "Record" or "Line" inputs. These outputs provide a fixed-level two-channel signal (L, R) to your recorder from whichever input is selected. The non-variable output level will be the same as the output of the selected source.

It is possible to dub or copy from one recorder to another by connecting the output of the source recorder to an unused set of stereo inputs (Aux 1, Aux 2). The signal will then be routed to the Record Out connectors when that input source is selected.

**12V IN/OUT REMOTE START JACKS:** The +12V DC input/output jacks provide the ability to remotely turn on and off other linked components such as power amplifiers having similar capabilities. They provide a continuous 12 V, not a momentary pulse.

## Installation Instructions

While the A.E. Ref does not dissipate an unusual amount of heat, it is important that it be provided with reasonable airflow to assure long, trouble-free operation. In addition, the following installation guidelines will help insure maximum sonic performance as well as reliable service:

1. Operate unit in upright and horizontal position, preferably on solid, non-metal shelving.
2. *Do not stack the preamplifier's two chassis on top of one another or on top of other audio components: not only could this cause overheating, but hum may be introduced into the preamplifier from the proximity of other power transformers. Do not stack components or other objects directly on top of the A. E. Ref. Allow at least six inches of space above and between the two A. E. Ref chassis.*
3. Do not place or operate your preamplifier (either chassis) on a soft or irregular surface such as a rug. This will prevent proper ventilation.
4. Do not operate your preamplifier without the top and bottom covers installed. These are required both for safety as well as shielding from interference (except in service operations by qualified personnel).

## Operating Procedure

### Start-Up:

1. Secure all rear-panel connections between A.E. Ref, power amplifier(s) and input sources.
2. Make sure the two supplied power supply cables are securely connected at all four points between active chassis and power supply before plugging the power cord into an electrical outlet (see "Connections" section of manual).
3. Plug three-prong power cord from rear of chassis into grounded AC wall outlet. The Power switch defaults to "off" when the unit is plugged into a power receptacle.

---

# Anniversary Edition Reference Preamp

---

4. Press Power switch (either on remote or front panel). Anniversary Edition information will appear in the display window for approximately 40 seconds indicating auto mute cycle operation. Upon completion, press Mute button to initiate operation.
5. Select input source, then BAL or SE as necessary.

## Shut-Down:

1. Activate "Mute" function.
2. Set Volume level to "0".
3. Turn off power amplifier(s).
4. Press Power switch to "off".
5. Turn off input sources.

## Troubleshooting:

It is possible for a static discharge to temporarily disable the microprocessor that allows the controls to function. If this should occur, depress the "Mute" button, then turn off the preamplifier and unplug the preamplifier from the A.C. receptacle for 30 seconds. Reconnect the A.C. plug and turn the preamplifier back on, along with other components. The controls should resume normal operation. If the problem persists, contact your dealer or Audio Research Customer Service at 763-577-9700.

## Servicing

Because of its careful design and exacting standards of manufacture, your A. E. Ref should require no routine maintenance other than periodic replacement of vacuum tubes. The remote control's batteries (AAA) should be replaced once a year.

**CAUTION:** Your A. E. Ref contains sufficient levels of voltage and current to be lethal. Do not tamper with a component or part inside the unit. Refer any needed service to your authorized Audio Research dealer or other qualified technician.

The ten 6H30 vacuum tubes inside your A. E. Ref are quality tested and graded and with normal use should not need to be changed for approximately 4,000 hours of use. The two matched 6550C tubes in the power supply should be changed after approximately 2000 hours of use. Replacement tubes should be of equivalent quality and are available from Audio Research. Note that tube numbers (V1, V2, etc.) match printed numbers next to tube sockets on circuit board. Note: Two spare 6H30 tubes are included with your unit.

Should service be necessary, please contact your Audio Research dealer, or Audio Research Customer Service at (763) 577-9700.

## Cleaning

To maintain the new appearance of these units, occasionally wipe the front panels and top covers with a soft, damp (not wet) cloth to remove dust. A mild, non-alkaline soap solution may be used to remove fingerprints or similar smudges. Cleaners containing abrasives should *not* be used as they will damage the anodized finish of the front panel. A small, soft paint brush is effective in removing dust from bevels, the recessed nameplate and other features of the front panel.



## Disposal and Recycling Guidelines

To dispose of this electronic product, do not place in landfill. In accordance with the European Union Waste Electrical and Electronic Equipment (WEEE) directive effective August 2005, this product may contain regulated materials which upon disposal require special reuse and recycling processing.

Please contact your dealer or importing distributor for instructions on proper disposal of this product in your country. Or, contact Audio Research Corporation (763-577-9700) for the name of your importing distributor and how to contact them.

Packing and shipping materials may be disposed of in a normal manner.



---

# Anniversary Edition Reference Preamplifier

---

## Limited Warranty

Audio Research Corporation products are covered by a 3-Year Limited Warranty, or a 90-Day Limited Warranty (vacuum tubes). This Limited Warranty initiates from the date of purchase, and is limited to the original purchaser, or in the case of demonstration equipment, limited to the balance of warranty remaining after original shipment to the retailer or importer.

In the United States, the specific terms, conditions and remedies for fulfillment of this Limited Warranty are listed on the warranty card accompanying the product in its shipping carton, or may be obtained from the authorized retailer or from the Audio Research Customer Service Department. Outside the United States, the authorized importing retailer or distributor has accepted the responsibility for warranty of Audio Research products sold by them. The specific terms and remedies for fulfillment of the Limited Warranty may vary from country to country. Warranty service should normally be obtained from the importing retailer or distributor from whom the product was purchased.

In the unlikely event that technical service beyond the ability of the importer is required, Audio Research will fulfill the terms and conditions of the Limited Warranty. Such product must be returned at the purchaser's expense to the Audio Research factory, along with a photocopy of the dated purchase receipt for the product, a written description of the problem(s) encountered, and any information necessary for return shipment. The cost of return shipment is the responsibility of the purchaser.

## Specifications

**FREQUENCY RESPONSE:** +0 -3dB 0.2Hz to 200kHz at rated output. (BALANCED, 200k ohms load.)

**DISTORTION:** Less than .006% at 2V RMS Balanced output.

**GAIN:** Main output (SE or BAL input): 12dB Balanced output, 6dB Single Ended output.  
Tape output: 0dB. (Processor input: 0dB Balanced)

**INPUT IMPEDANCE:** 120K ohms Balanced, 60K ohms SE, Inputs (7): CD, TUNER, VIDEO, PHONO, AUX 1, AUX 2, PROCESSOR. (XLR and RCA connectors).

**OUTPUT IMPEDANCE:** 600 ohms Balanced, 300 ohms SE main (2), 20K ohms minimum load and 2000pF maximum capacitance. Outputs (3): 2 main, 1 tape (XLR and RCA connectors).

**OUTPUT POLARITY:** Non inverting.

**MAXIMUM INPUT:** 20V RMS maximum Balanced, (10V RMS SE).

**RATED OUTPUTS:** 2V RMS (1V RMS SE) into 200K ohm balanced load (maximum balanced output capability is 30V RMS at less than 0.5% THD at 1kHz).

**CROSSTALK:** -80dB or better at 1kHz.

**CONTROLS:** Volume (104 steps), Select Input. Push Buttons: Power, Proc, BAL/SE, Mono, Invert, Mute.

**POWER SUPPLIES:** Electronically regulated low and high voltage supplies. Automatic 40 sec. warm-up/brown-out mute. Line regulation better than .01%.

**NOISE:** 1.7uV RMS residual IHF weighted balanced equivalent input noise with volume at 1 (109dB below 2V RMS output.)

**TUBE COMPLEMENT:** (8)-6H30P dual triodes, plus (2 each) 6550C and 6H30P in power supply.

**POWER REQUIREMENTS:** 100-135VAC 60Hz (200-270VAC 50/60Hz) 220 watts. Standby: 0.8 watts.

**DIMENSIONS:** 19" (48 cm) W x 7" (17.8 cm) H (standard panel) x 15.5" (39.4 cm) D. Handles extend 1.5" (3.8 cm) forward of the front panels.

**WEIGHT:** **Audio Chassis:** 28.9 lbs. (13.25 kg) Net; 36.3 lbs. (16.65 kg) Shipping.  
**Power Supply Chassis:** 39.0 lbs. (17.88 kg) Net; 47.0 lbs. (21.56 kg) Shipping.

Specifications subject to change without notice.

©2010 Audio Research Corporation.





**DISPLAY:** Selects one of seven display illumination levels, including off. When off, the display can be reactivated for 10 seconds at its lowest level by pressing any button (except Power) on remote or front panel.

## **Installation of Vacuum Tubes**

After removing the top cover and the vacuum tubes packed in protective foam, see the accompanying illustrated sheet for instructions on installing the tubes for your A. E. REF in their proper locations in the power supply and audio section. Note that the numbers written on each tube correspond to a "V" number printed on the circuit board next to each tube socket. Insert each tube firmly, carefully aligning the tube pins with the corresponding socket holes.

Also remove the pad from behind the gold-and-red capacitors on the rear circuit board; this pad protects the capacitors from movement during shipping. Save the pad and the foam for the tubes, as well as all other packing materials, for possible use in future shipment of your pre-amplifier. Replace the top cover before plugging in and turning on your A. E. REF.