



In Car Video

IVMR-7001

Operating and installation instructions



 **BLAUPUNKT**

Front view

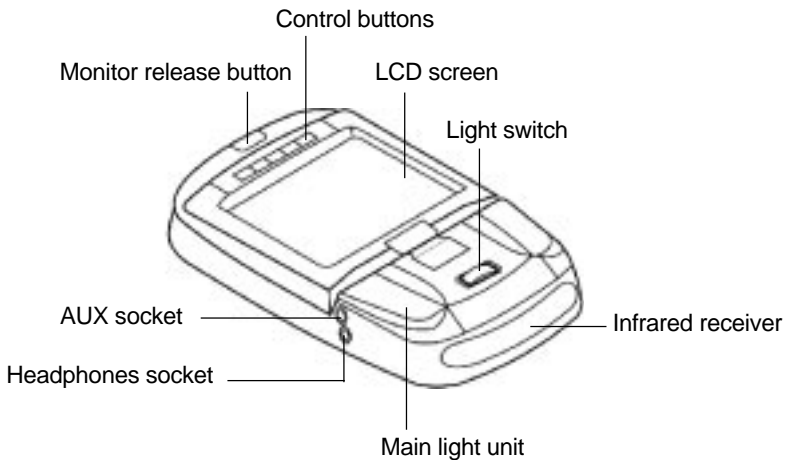

Rear view

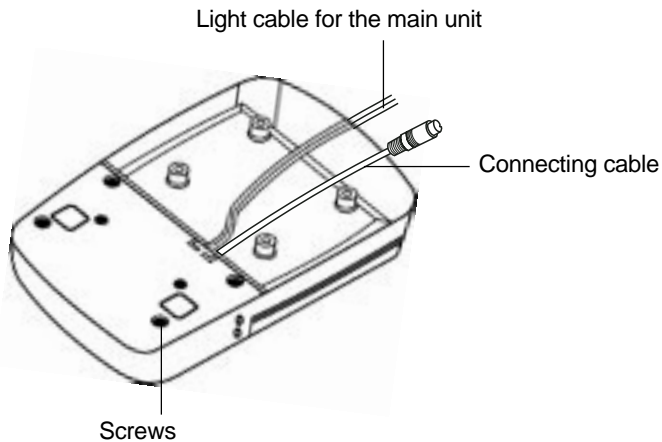

CONTENTS

Notes for the user	19
Supplied equipment	20
Using for the first time	21
Using the interior light	21
Changing the light bulb	22
Light bulb specifications	22
Wiring	22
Monitor connection	22
Installing the monitor	23
Operation	24
Opening the monitor	24
Repositioning the monitor	24
Closing the monitor	24
Switching on the monitor	24
Display controls	25
Remote control	25
OSD menu	26
IR-Headphones	28
Specifications	30
Guarantee	31
Appendix	31
Changing the battery in the remote control	31

Notes for the user

Please observe all the warning notices, precautionary measures and maintenance tips contained in these operating instructions so as to extend the life of your monitor.

- To avoid causing a road accident, never use the monitor during the journey.
- Do not place the monitor's aerial in the following positions:
 1. Positions in which the driver's view could be restricted.
 2. Positions in which the aerial could become a danger to safety (e.g. handbrake, steering wheel, gearshift lever and air-bag).
- Do not install the aerial in locations where it could restrict the driver's rear view. Do not allow the aerial to jut out past the side of the vehicle.
- Attach the aerial carefully so that you do not lose it whilst driving, particularly in the rain or in the car-wash.
- To avoid the danger of receiving an electric shock and damaged to the monitor, make sure that the monitor cannot become wet or moist. If, however, this does occur, switch the device off, disconnect the electrical cable, and take the monitor to your local specialised dealer as quickly as possible or send it in to our customer service centre.
- Only operate the device with the recommended electrical supply of 12V direct current.
- Make sure you do not place or hang any objects on the electrical cable since this could damage it.
- Avoid laying the cable haphazardly or twisting it. Keep it away from heated objects.
- Do not attempt to repair the electrical cable if it becomes damaged or severed – instead, replace it immediately with a new one.
- Make sure that no metallic or inflammable objects make their way into the monitor's insides through the ventilation slots.
- Do not attempt to open or dismantle the monitor, since you could suffer an electric shock as a result.
- If you detect smoke or a strange smell, disconnect the electrical cable immediately and take it to your local specialised dealer or send it in to our customer service centre.
- If the monitor's housing is damaged or broken, take it to your local specialised dealer or send it in to our customer service centre.
- Avoid using the monitor in places where it is subjected to dust, dirt or moisture.
- Do not install the monitor in places where it is subjected to direct sunlight or extreme temperatures.

- Do not subject the monitor to the wet or moisture.
- After installing the monitor, avoid knocking it or pulling it downwards excessively, since this will loosen the screws and the monitor could drop off.

Supplied equipment

The monitor is supplied with all parts listed below. Please check that your device is supplied with all the parts. If one of the listed parts is missing, please contact your dealer immediately.

Standard package

- Monitor (including mounting fixture)
- Remote control with battery
- IR-Headphones
- 500 cm long, 8-pin system cable (only for AV signal converter)
- Operating instructions

Using for the first time

Using the interior light

There are three settings for the interior light: OFF, DOOR and ON (see diagram below).

OFF: The lights are switched off.

DOOR: With this setting, the lights only come on when the vehicle's doors are opened.

ON: The lights are switched on.



Notes:

- There is no electrical cable connected to position "B", since "B" is connected to the ground via two screws.
- The power supply must be 12 volts.

Circuit diagram

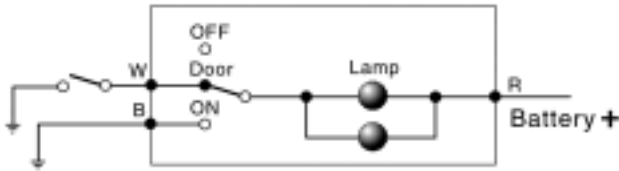

W = White = Connection to the sensor

B = Black = Ground

R = Red = Electrical connection

USING FOR THE FIRST TIME

Changing the light bulb

To fit a new bulb, proceed as follows:

- ⇒ Set the light switch to “OFF”.
- ⇒ Push back the bulb cover and open it (see diagram below).
- ⇒ Remove the old bulb and dispose of it.
- ⇒ Fit a new bulb.
- ⇒ Close the bulb cover.

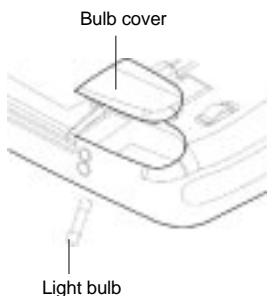

Light bulb specifications

Diameter:	8 mm
Length:	29 mm
Voltage:	12 V direct current, 5 W
Type:	Stanley A3022C or a type with the same specifications

Wiring

Bulb for the main unit

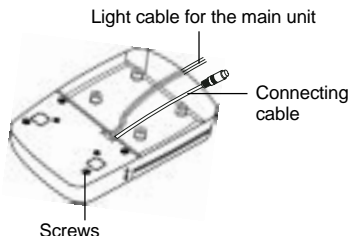

Red = Electrical supply (12 V)
White = Internal lighting system
Black = Ground

Caution:

- The screws have different sizes. Make sure that you insert the screws in the correct positions.
- Make sure that the screws are screwed tight to ensure a good ground connection.

Monitor connection

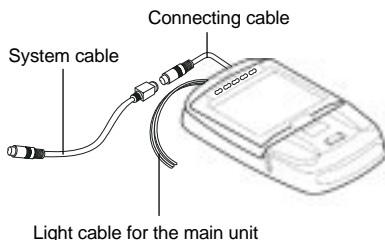

Installing the monitor

Select a suitable position for secure installation of the monitor:

- The device must not distract the driver or restrict the driver's view.
- The ability to enter and get out of the vehicle must not be impeded.
- The device must not be installed in such a way that could prevent the other vehicle components from functioning properly (e.g. sliding sunroof).
- Make sure that the device is installed in a safe and secure position and cannot become detached in the event of an emergency stop.
- Do not attach the device merely to the roof liner.
- If you need to drill additional holes, make sure you do not drill through the vehicle's sheet metal.
- Avoid using the monitor over a longer period of time whilst the engine is off so as to prevent the battery from becoming drained.

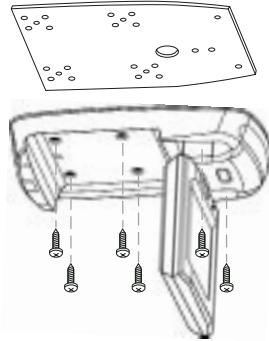

OPERATION

Operation

Opening the monitor

- ⇨ Press the monitor release button to flip down the LCD display.
- ⇨ To watch the television, lower the monitor until it is at an angle of 90 degrees to the main unit.



Repositioning the monitor

The monitor can be rotated by up to 30 degrees to the right and left from its central viewing position (see the following diagram).

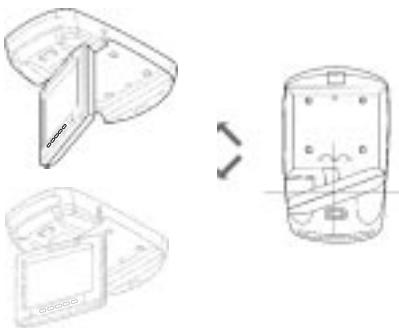

Closing the monitor

- ⇨ Rotate the monitor back to its central viewing position (see the following diagram).

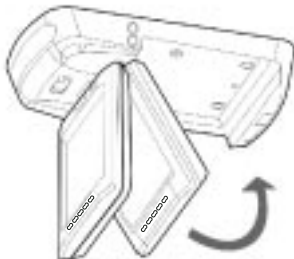

- ⇨ Push the monitor back into its main unit so that the screen clips back into the releasing/locking mechanism.

Switching on the monitor

Press the power-on button on the main unit or on the remote control to switch the monitor on/off.

Note:

Before the monitor is switched on, the power indicator lights up orange. This means that the monitor is connected to the 12 V direct current electrical supply. Furthermore, "NO SIGNAL" will flash on and off in the on-screen display (OSD) as long as there is no A/V input signal present.

Display controls

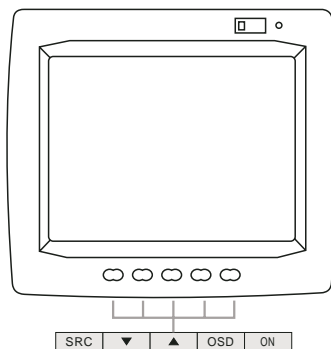

- **POWER:**

This button is used to switch the main unit on/off.

- **OSD:**

⇒ Press the “OSD” button to open the OSD menu or select a function in the OSD menu.

- **SRC:**

⇒ Press this button to select the AV channel (channel 1 – channel 5) of the AV signal converter.

▲: You can use this button to increase the volume.

You can also navigate upwards in the OSD menu using this button.

▼: You can use this button to decrease the volume.

Press this button to navigate downwards in the OSD menu.

Remote control

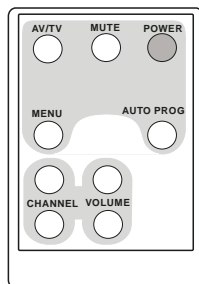

- **POWER:**

To switch the main unit on/off

- **MUTE (Stumm):**

Turns down the volume to zero

- **AV/TV:**

⇒ Press this button to switch between AV and TV channels.

Note:

This function is only available if the E/A box is connected or the E/A box together with the tuner box.

- **AUTO PROG (Automatic programming):**

Select this option on the remote control or in the OSD menu if you want the monitor to automatically search and store the television channels.

The specifications are as follows:

TV system	Channels
USA	2-69
JAPAN	1-62
PALB/G	2-69
PALD/K	1-57
PALA/I	21-69

- **FM CHAN:**

Use this option to select the FM channel. This channel is set by default to "OFF".

The specifications are as follows:

TV system	FM frequency (MHz) in steps of 0.2 MHz
-----------	--

USA	OFF / 88.1 - 91.9
JAPAN	OFF / 77.1 - 80.9
PALB/G	OFF / 88.1 - 91.9
PALD/K	OFF / 88.1 - 91.9
PALAI	OFF / 88.1 - 91.9

- **AUTO PROG (Automatic programming):**

Please refer to the "AUTO PROG" function in the section describing the remote control.

- **AV OUT:**

Select this option to switch between the AV output modes "Constant" and "Variable".

- **ZOOM :**

This mode is set by default to "Full". You can use the ▲ and ▼ buttons to switch between the following settings:

Full = for displaying a 4:3 signal on a 16:9 screen format

ZOOM1 = Picture height expansion, zoom factor = 4/3

WIDTH1 = Picture height expansion and different picture width change

Normal = Side ratio of 4:3

ZOOM2 = Zoom factor = 8/7, picture height expansion

WIDTH = Different picture width change

WIDTH2 = Picture height expansion and different picture width change

ZOOM3 = vertical expansion, zoom factor = 8/7

- **SPEAKER:**

Select the "SPEAKER" option and then use the ▲ and ▼ buttons to switch the monitor loudspeaker on/off.

- **REVOLVE:**

This function and the ▲ and ▼ buttons allow you to reverse the picture (i.e. right-to-left reversed).

- **RESET PICTURE:**

Select the "RESET PICTURE" option to reset the adjusted parameters back to their factory defaults.

- **MAIN MENU:**

If you are in the submenu, you can return to the main menu by selecting this option.

IR-HEADPHONES

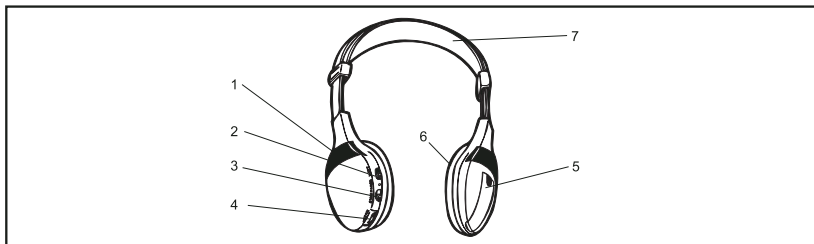

1. Infrared sensors
2. On/off switch
3. Stereo / mono
4. Volume control
5. Battery compartment cover
6. Ear cushion
7. Adjustable headband

Operating instructions

1. Switch on the audio/video device that is connected to the transmitter.
3. Adjust your preferred volume using the volume control on the left whilst making sure you do not obstruct the sensors.

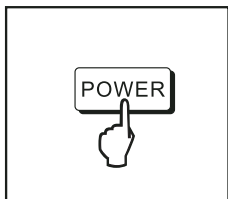

2. Move the on/off switch on the headphones to the on position.

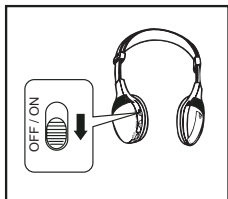
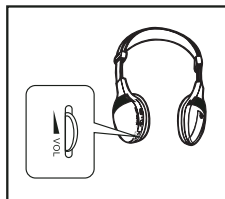

4. For stereo audio, move the switch to the stereo position. Move the switch to the mono position for mono audio/video devices.

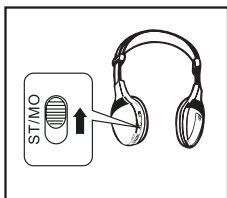

5. Reception position
The headphones/receiver receive audio signals within certain ranges from any direction and directly. You will enjoy the best reception if you stay within a distance of 5 metres from the transmitter.

Specifications

Surround transmitter:

Power consumption	12 V DC 200 mA
Effective angle	120 degrees
Weight	approx. 55 g

Stereo headphones:

Type	dynamic, open
Transducer system	40 mm Mylar membrane
Impedance	32 ohm +/- 6.4 ohm
Frequency response	20 Hz – 23 KHz
Sound intensity level	98 dB/rated deviation
Distortion	1 % total harmonic distortion at rated deviation
Infrared wavelength	845 mm +/- 5 mm
Modulation	high frequency modulation
Carrier frequency	right 2.8 MHz, left 2.3 MHz
Power supply	2 DCV (1.5 V AAA x 2)
Battery operating time (at 10 mV output power)	approx. 48 hours
Weight	approx. 170 g (without batteries)
Range	approx. 7 metres

SPECIFICATIONS

Specifications

Screen size: 7" Monitor, A1

Screen resolution:
1440 (H) x 234 (V)

Active area: 154.08 (H) x
86.58 (V)

Pixel pitch (mm): 0.107 (H) x
0.370 (V)

Signal system: Dual system NTSC/
PAL

Brightness: 400 cd/m²

Contrast ratio: 150

Viewing angle:
Left/right: 60/60 degrees
Top/bottom: 60/30 degrees

Response time (rise/fall):
25/30 ms

Video input level: 1.0 Vpp ± 10%

Audio input level: 0.3 Vrms

A/V input level: 1.0 Vpp ± 10%

AUX input level: 1.0 Vpp ± 10%

Carrier frequency for IR sensor:
L-CH : 2.3 MHz
R-CH : 2.78 MHz

Headphones output level:
1.0 Vpp

Operating voltage (direct current
voltage): 11 - 15 V

Power consumption:
9 W

Operating temperature:
0 - 60° C

Storage temperature:
-25 - 80° C

Dimensions: 320 x 195 x
60 mm

Weight: 1,200 ± 50 g

Guarantee

The scope of the guarantee depends on the regulations in force within the country in which the unit was purchased.

We provide a manufacturer guarantee for our products bought within the European Union. You can view the guarantee conditions at www.blaupunkt.de or ask for them directly at:

Blaupunkt GmbH, Hotline CM/PSS 6,
Robert Bosch Str. 200,
D-31139 Hildesheim, Germany

This guarantee does not cover damage due to wear, incorrect usage or commercial use.

If you wish to enforce a claim under the manufacturer's guarantee that is provided by Blaupunkt, please send the faulty equipment together with the purchase receipt to the Blaupunkt customer service centre in your country. You can find out which address is closest to you by contacting the telephone hotline listed on the back page of this booklet. Blaupunkt retains the right to rectify defects or supply a replacement.

Appendix

Changing the battery in the remote control

- ⇨ Push the battery compartment button to the right (see A below).
- ⇨ Pull the battery compartment out of the remote control (see B below).
- ⇨ Change the battery.

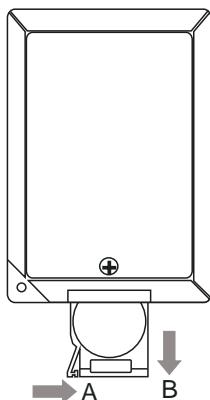

Service-Nummern / Service numbers / Numéros du service après-vente / Numeri del servizio di assistenza / Servicenummers / Telefonnummer för service / Números de servicio / Números de serviço / Servicenumre

Country:	Phone:	Fax:	WWW:
Germany	(D) 0180-5000225	05121-49 4002	http://www.blaupunkt.com
Austria	(A) 01-610 390	01-610 393 91	
Belgium	(B) 02-525 5454	02-525 5263	
Denmark	(DK) 44 898 360	44-898 644	
Finland	(FIN) 09-435 991	09-435 99236	
France	(F) 01-4010 7007	01-4010 7320	
Great Britain	(GB) 01-89583 8880	01-89583 8394	
Greece	(GR) 0800-550 6550	01-576 9473	
Ireland	(IRL) 01-4149400	01-4598830	
Italy	(I) 02-369 6331	02-369 6464	
Luxembourg	(L) 40 4078	40 2085	
Netherland	(NL) 023-565 6348	023-565 6331	
Norway	(N) 66-817 000	66-817 157	
Portugal	(P) 01-2185 00144	01-2185 11111	
Spain	(E) 902-120234	916-467952	
Sweden	(S) 08-7501500	08-7501810	
Switzerland	(CH) 01-8471644	01-8471650	
Czech. Rep.	(CZ) 02-6130 0441	02-6130 0514	
Hungary	(H) 01-333 9575	01-324 8756	
Poland	(PL) 0800-118922	022-8771260	
Turkey	(TR) 0212-3350677	0212-3460040	
USA	(USA) 800-2662528	708-6817188	
Brasil (Mercosur)	(BR) +55-19 3745 2769	+55-19 3745 2773	
Malaysia (Asia Pacific)	(MAL) +604-6382 474	+604-6413 640	

Blaupunkt GmbH

