



MCP35 MASTER CONTROL PANEL

PI-35/SI-35 SYSTEMS

INSTALLATION AND SERVICE MANUAL

IT IS RECOMMENDED THAT THIS ENTIRE MANUAL BE CAREFULLY READ BEFORE ATTEMPTING TO INSTALL THE MASTER CONTROL PANEL OR ANY OF THE SYSTEMS COVERED HEREIN.

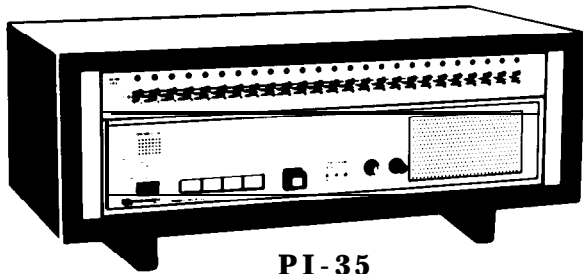

PI-35

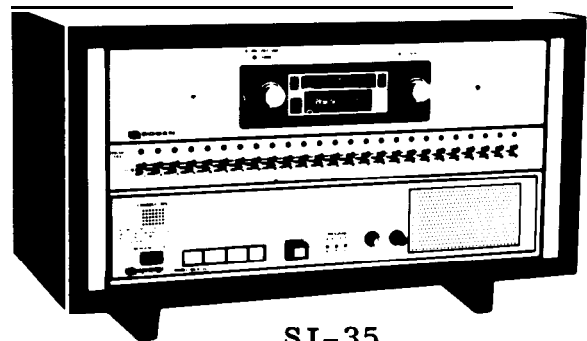

SI-35

TABLE OF CONTENTS

SECTION ONE: MCP35 MASTER CONTROL PANEL.

TECHNICAL SPECIFICATIONS

DESCRIPTION

INSTALLATION

Unpackin

TECHNICAL SPECIFICATIONS 8

DESCRIPTION 8

ASSOCIATED EQUIPMENT 8

Switchbanks..... 8

Switchbank Modules..... 9

SCR25 Call-In Module 9

TZMA Time Zone Module 9

Staff Station Equipment 9

Call/Emergency Switches 9

APPENDIX a-1

GENERAL WIRING. a-1

STATION WIRING. a-1

CONTROL CENTER WIRING. a-1

MAINTENANCE. a-1

Bogen Service a-1

Replacing Components a-3

Replacement Parts a-3

SECTION ONE: MCP35

TECHNICAL SPECIFICATIONS

Rated Output:	Program-35W RMS Intercom- 8W RMS
Frequency Response:	Program- ± 2 dB, 40Hz to 20kHz Intercom-Shaped for maximum intelligibility
Distortion:	Less than 2% from 40Hz to 20kHz
Inputs:	Two Lo-Z balanced microphone inputs, convertible to Hi-Z; Hi-Z unbalanced AUX input; Hi-Z booster input
output:	Balanced 25VCT line
Input Sensitivity (for rated output):	Microphone-300 μ V Auxiliary- 1 00mV
Power Requirements (120VAC, 60Hz):	100W maximum
Dimensions:	19"W x 3-1/2"H x 10"D (48.2 x 8.9 x 25.4cm)
Weight:	Approximately 10 lbs. (4.8 kg)
Controls & Indicators:	Input Selector Pushbuttons-MIC 1, MIC 2, AUX Level Controls-MONITOR/LISTEN, PROGRAM (Front Panel) Gain: AUX, MIC 1, MIC 2, LISTEN, TALK, EMERGENCY PAGE (Rear Panel, screwdriver-adjustable) Distribution Switches-ALL ROOMS, EMERGENCY PAGE Indicators-LED LEVEL Indicators
Finish:	Bogen Sand with color-coded guides for PROGRAM, INTERCOM, and EMERGENCY PAGE

DESCRIPTION

Bogen Model MCP35 Master Control Panel provides facilities for instantaneous two-way communication and distribution of paging, background music, or other program material for up to 75 speaker-equipped stations. A built-in 8-watt intercom amplifier features a frequency response shaped for maximum intelligibility. A separate 35-watt program amplifier ensures that program material and/or emergency announcements are clearly heard and easily understood. The front panel features step-by-step instructions and color-coded indicia which permit even first-time users to easily operate the system: the intercom channel guide indicia color-code is green, the program channel guide indicia color-code is amber, and the emergency page guide indicia color-code is red.

Input facilities are provided for external microphones, tuner, cassette player, or other background music source. Level controls and audible and visual monitoring of program material are provided. Distribution is accomplished by simple pushbutton program selection and by following color-coded indicia. Emergency announcements to all locations take precedence over program distribution and are accomplished with a single pushbutton selection. Provision is included for time signalling, telephone paging, and for connection to a booster amplifier.

The MCP35 Master Control Panel is used in conjunction with Bogen Room Selector and Annunciator Panels to direct intercom, or program, to selected staff stations. Replies are heard through the front panel speaker of the MCP35. Calls from staff locations are initiated through the use of call-in switches and are announced by light and tone annunciation. Provision for voice call-in is included.

Model MCP35 control panel permits the user to:

- establish direct two-way voice communication between the control panel and any speaker-equipped location via a switchbank and the press-to-talk/release-to-listen pushbutton, while maintaining simultaneous distribution of program material to any other speaker-equipped location.
- disseminate voice announcements to any individual, group, or all speaker-equipped locations.
- disseminate program material to any individual, group, or all speaker-equipped locations.
- easily make program source selection by pressing the appropriately labelled pushbutton corresponding to input from

either of two separate low-impedance, balanced microphones, or one high-impedance auxiliary program source (tuner, cassette player, phono).

- transmit a program or voice announcement simultaneously to all speaker-equipped locations via use of a program source pushbutton with the all rooms pushbutton.
- audibly (monitor speaker) and visually (LED) monitor all program material.
- instantaneously disseminate emergency messages to all speaker-equipped locations by simply pressing the red emergency pushbutton; this action bypasses all other controls, overrides all other programs, and transmits the emergency message at a predetermined volume level.

Provisions have been made for:

- automatically sounding a warning tone signal over any loudspeaker selected for two-way voice communications, alerting personnel to the call and preventing unauthorized

monitoring. The warning tone signal repeats at regular intervals whenever a location is being monitored (can be jumper defeated).

- voice-call origination to the control panel from any location equipped with a customer-supplied SPDT momentary switch.
- prevention of control center monitoring of any location equipped with a Bogen Call/Privacy Switch.
- staff call origination by momentarily pressing a call origination switch, which causes a repetitive tone signal to sound at the control panel and lights the annunciator lamp associated with the calling location. The annunciator lamp remains lit until the call is answered.
- distribution of time signal/telephone page to all speaker-equipped locations.
- connection of a tuner or a cassette tape player.

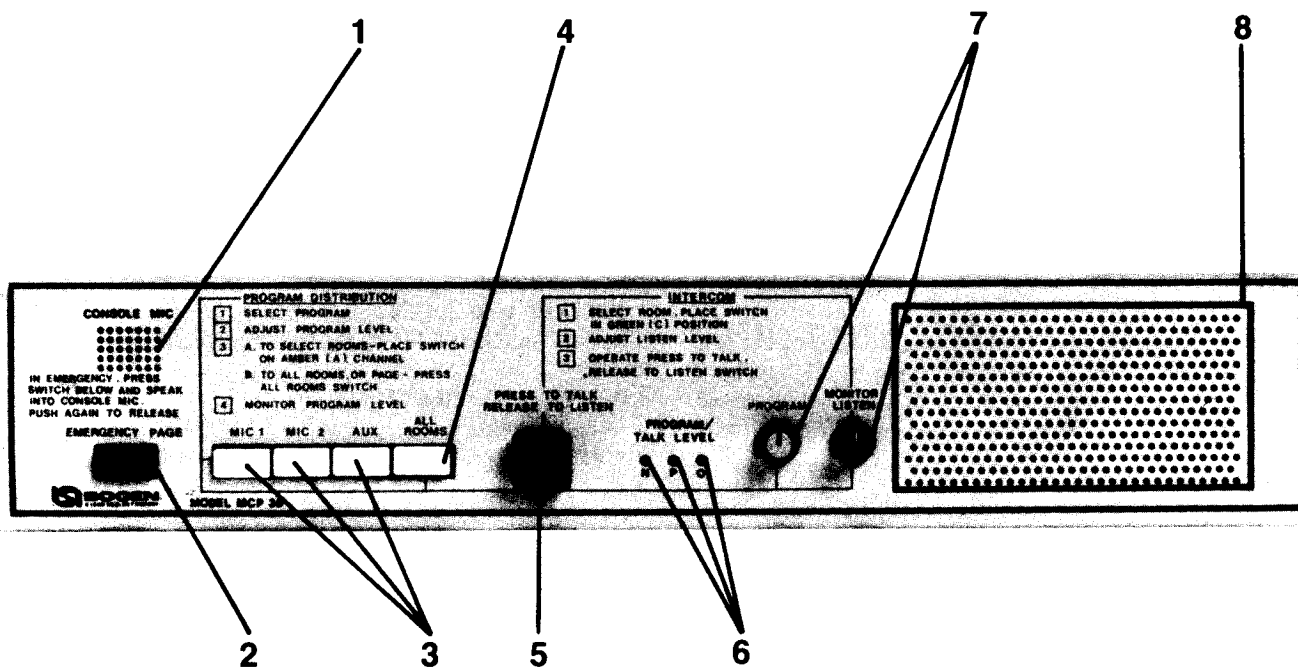

Figure 1—Model MCP35, Front Panel

1. CONSOLE MIC—Used as microphone 1 or in conjunction with the emergency page or press-to-talk/release-to-listen (intercom) pushbuttons.
2. EMERGENCY PAGE—Red pushbutton used to make announcements to all speaker stations; overrides program distribution and/or switchbank settings.
3. PROGRAM DISTRIBUTION—Pushbuttons used to make input source selection; choose from or mix input from MIC 1 (console or external microphone), MIC 2 (external microphone), or AUX (information from tuner/cassette player/phono), as desired.
4. ALL ROOMS—Pushbutton used to distribute program to all speaker stations with selector panel switches set to “A” or “O” channel.
5. INTERCOM—PRESS TO TALK/RELEASE TO LISTEN—Pushbutton used to communicate with speaker station selected from switchbank channel “C”. Does not affect program distribution to other stations.
6. PROGRAM/TALK LEVEL—LED indicators; N (normal) lights green to indicate proper signal level; P (peak) lights amber to indicate occasional higher than normal signal level; O (overload) lights red to indicate possible signal clip.
7. PROGRAM—Amber color knob used to adjust program volume level to speaker stations.
MONITOR LISTEN—Green color knob used to adjust volume level to front panel speaker.
8. FRONT PANEL SPEAKER—Used to monitor a program or to listen to a station via the intercom (C) channel.

INSTALLATION

NOTE

Refer to Appendix for wiring information.

UNPACKING

Your unit was carefully checked before leaving the factory; inspect the shipping container and the unit closely for improper handling. If the unit has been damaged, make an immediate claim to the distributor from whom it was purchased. If the unit was shipped directly to you, save all shipping material, notify the carrier immediately and place your claim.

POWER AND GROUNDING

The MCP35 Master Control Panel operates from a 120VAC, 60Hz source and consumes no more than 100 watts. An AC line cord, terminated in a three-prong plug, is provided. The line cord should be plugged into a three-wire grounded outlet providing a nominal 120VAC, 60Hz power source. It is important to ground the unit; therefore, if a three-wire outlet is not available, an adapter such as Leviton No. 5017 should be used to convert a standard two-wire outlet for use with three-wire plugs. The adapter is provided with a grounding pigtail which should be connected to the screw holding the wall plate to the receptacle. In some areas, the wall plate screw is not grounded. In this case it is necessary to connect a grounding wire from the EARTH GND terminal on the rear chassis of the MCP35 to a water or steam pipe.

AUXILIARY POWER

An 840-watt, three-wire grounded outlet is provided on the rear panel to supply power to accessory equipment. Auxiliary equipment connected to this outlet will be grounded, provided the Master Control Panel line cord has been properly grounded.

LINE-MATCHING TRANSFORMERS

The MCP35 Master Control Panel is designed for 25-volt constant voltage distribution systems. All system loudspeakers must be provided with line-matching transformers.

CAUTION

Speakers and transformers must be properly matched with respect to power requirements.

INPUT CONNECTIONS

MICROPHONE INPUTS-terminal strips on the rear of the MCP35 provide for two low-impedance balanced or unbalanced microphone inputs. Two-conductor shielded microphone cable should be used.

TUNER/PHONO/TAPE INPUTS-two AUX jacks accept single-conductor shielded cable.

TAPE RECORDER/BOOSTER AMP INPUT-accepts a two-conductor shielded cable.

INTERCOM CALL-IN LINE-connect parallel lines from station call-in switches with two-conductor shielded cable.

SWITCHBANK CONNECTION-nine-pin plug connects three pairs plus three control wires from a switchbank.

TIME CLOCK INPUT-terminal strip provides single-circuit time capability.

TELCO PAGE INPUT-jack accepts telephone paging input from Bogen Model WMT-1 accessory transformer.

OUTPUT CONNECTIONS

A 25VCT external booster output is provided.

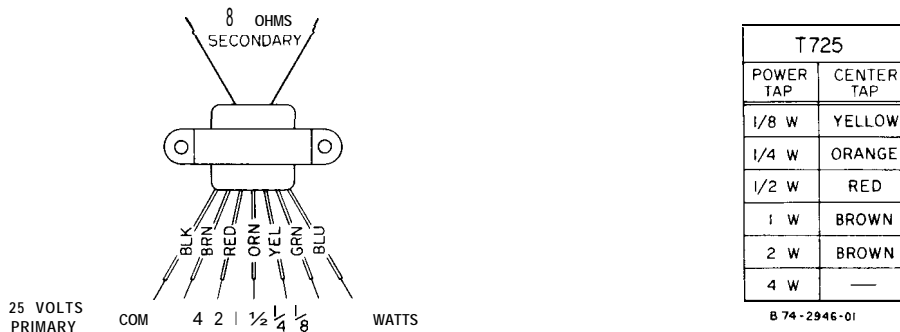

Figure 2-Model T725, Line-Matching Transformer

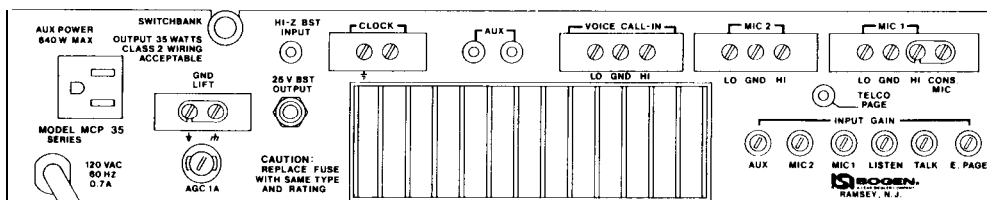

Figure 3-Model MCP35, Rear Panel

ADJUSTMENTS AND MODIFICATIONS

GAIN ADJUSTMENTS

(For Qualified Service Personnel Only)

Gain adjustments are made with a screwdriver at the rear chassis; set the INPUT GAIN controls so that signal clipping cannot occur. Proceed as follows:

1. Apply input(s) to the desired channel(s).
2. Set the corresponding front panel control(s) to maximum.
3. Adjust each appropriate INPUT GAIN control (looking at rear panel, turn **clockwise to increase** or **counterclockwise to decrease** gain) so that the red "0" (overload) LED lights; then, turn counterclockwise **only** until the LED is extinguished.

MODIFICATIONS

Defeating MIC 1 to CONSOLE MIC configuration:

1. Locate and loosen the two screws securing the jumper link on the rear chassis terminal strip connecting the MIC 1 HI terminal to the CONSOLE MIC terminal. (Refer to Figure 3-Rear Panel illustration.)
2. Move the link down, away from the MIC 1 HI terminal.
3. Tighten the screw securing the link to the CONSOLE MIC terminal.

4. Remove the 1-ohm resistor (or, on some printed circuit boards, the wire jumper) behind the "S38" designation on the pc board.

ASSOCIATED EQUIPMENT

TIME TONE/TELCO PAGE

A time tone can be put through all speakers when the CLOCK terminals are joined together through a closure, as with a Bogen CLK-6A Master Program Clock. Telco Page is accomplished through a telephone audio pair plus closure. The audio pair connects to a WMT-1 transformer which is plugged into the TELCO PAGE jack. A 24-ohm resistor is connected in series with the closure across the CLOCK terminals. When both are included, the time tone change option has precedence over Telco Page.

EXTERNAL BOOSTER AMPLIFIER

Model BPA-60 or BPA-125 (60 or 125 watts, respectively) provides increased power output. To install, simply connect a cable, terminated with male phono plugs, from the MCP35 HI-Z BST INPUT jack to the HI-Z INPUT jack on the rear panel of the amplifier. Connect the 25V OUTPUT from the amplifier to the 1/4" phone jack (25V BST OUTPUT).

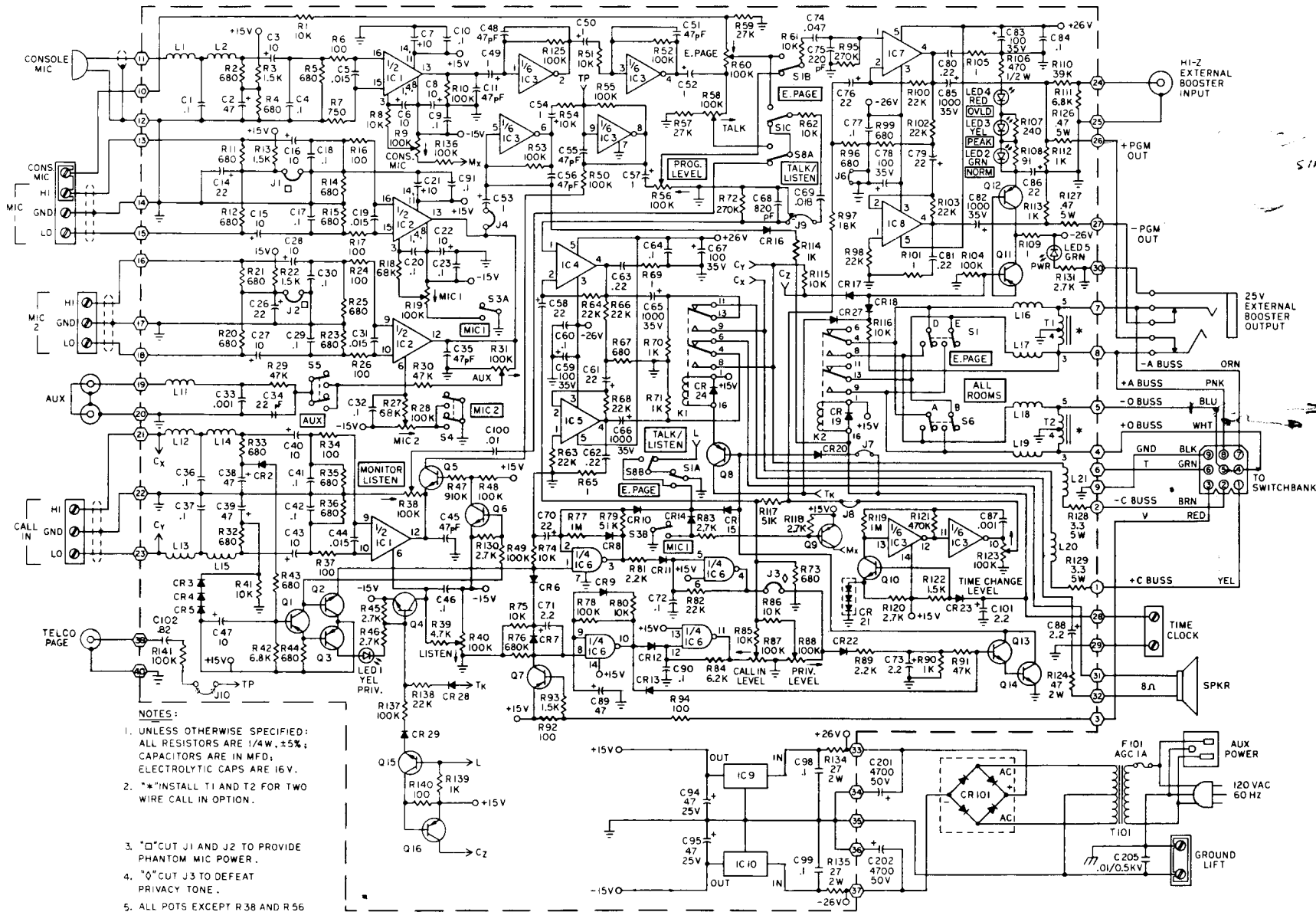

- NOTES:
- UNLESS OTHERWISE SPECIFIED: ALL RESISTORS ARE 1/4W, ±5%; CAPACITORS ARE IN MFD; ELECTROLYTIC CAPS ARE 16V.
 - * * *INSTALL T1 AND T2 FOR TWO WIRE CALL IN OPTION.
 - "□" CUT J1 AND J2 TO PROVIDE PHANTOM MIC POWER.
 - "○" CUT J3 TO DEFEAT PRIVACY TONE.
 - ALL POTS EXCEPT R38 AND R56 ARE SCREWDRIVER ADJUSTABLE.
 - ARROWS ON POTS INDICATE CLOCKWISE ROTATION.

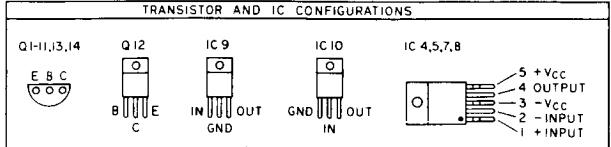
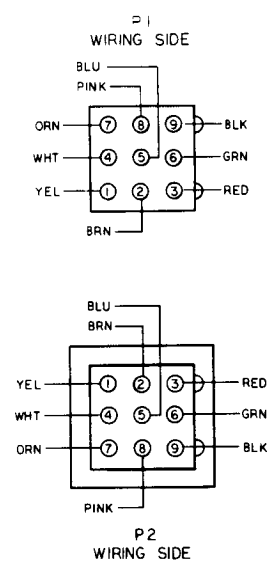
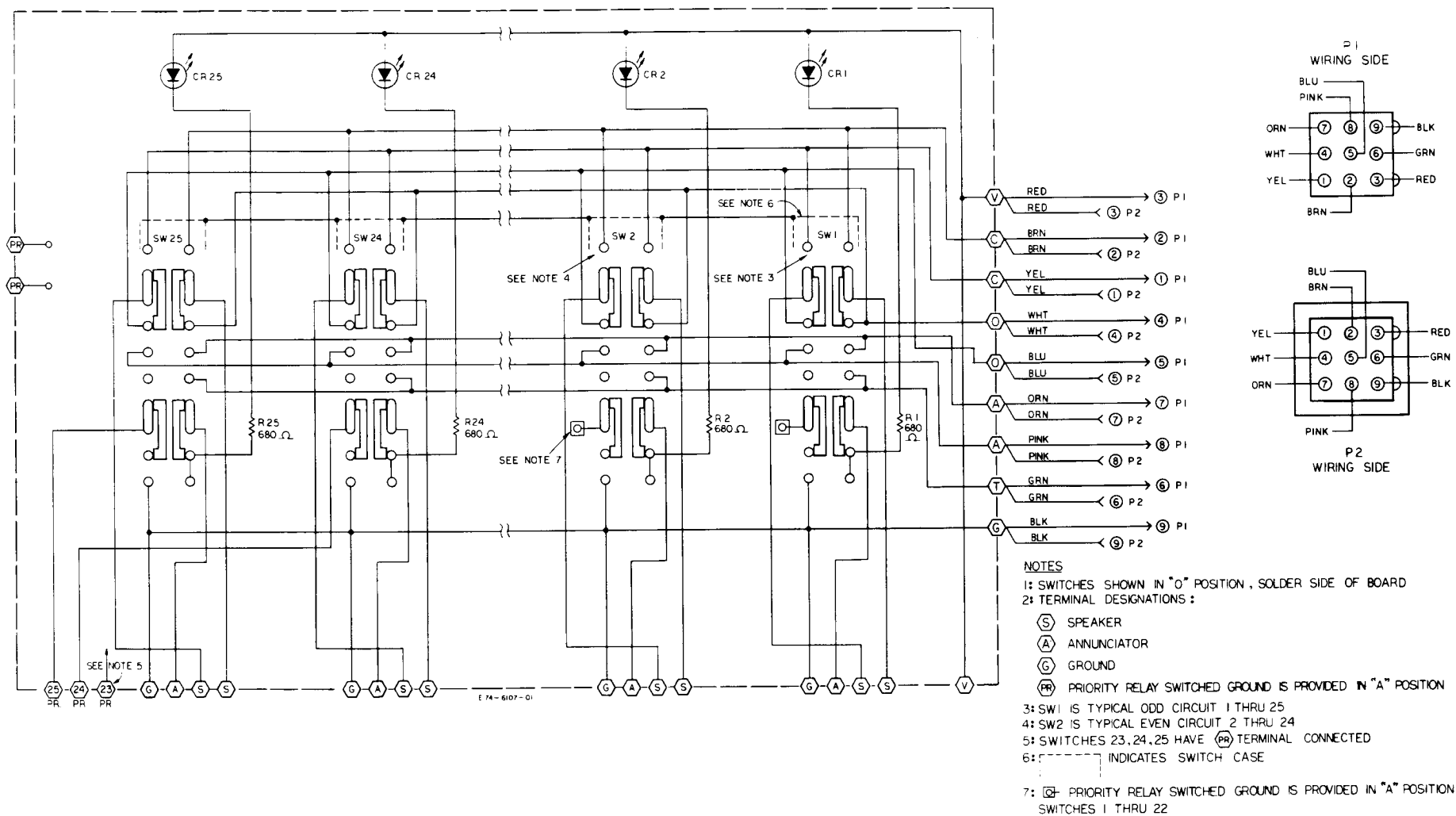

Figure 4—Model MCP35, Schematic Diagram



- NOTES**
- 1: SWITCHES SHOWN IN "O" POSITION, SOLDER SIDE OF BOARD
 - 2: TERMINAL DESIGNATIONS:
 - (S) SPEAKER
 - (A) ANNUNCIATOR
 - (G) GROUND
 - (PR) PRIORITY RELAY SWITCHED GROUND IS PROVIDED IN "A" POSITION - 3: SW1 IS TYPICAL ODD CIRCUIT 1 THRU 25
 - 4: SW2 IS TYPICAL EVEN CIRCUIT 2 THRU 24
 - 5: SWITCHES 23, 24, 25 HAVE (PR) TERMINAL CONNECTED
 - 6: ----- INDICATES SWITCH CASE
 - 7: (G) PRIORITY RELAY SWITCHED GROUND IS PROVIDED IN "A" POSITION SWITCHES 1 THRU 22

Figure 5—Model SBA225, Schematic Diagram

SECTION TWO: Multi-Graphic PI-35 SYSTEM/SI-35 SYSTEM

TECHNICAL SPECIFICATIONS

Capacity:	PI-35 System-25 Stations, maximum SI-35 System-25 Stations, expandable (in multiples of 25) to 75 stations
Dimensions:	PI-35: 8-1/2 "H x 20-1/2 "W x 11 "D (20.3 x 52 x 27.9cm) SI-35: 12 "H x 20-1/2 "W x 11 "D (35 x 52 x 27.9cm)
Weight:	PI-35: Approximately 20 lbs. SI-35: Approximately 35 lbs.
Controls:	Room Selector and Annunciator Panels-25 LED annunciators; 25 three-position switches-PROGRAM, OFF, INTERCOM
Finish:	Cabinet-Simulated walnut veneer Panels-Bogen Sand with color-coded guides for PROGRAM, INTERCOM, and EMERGENCY PAGE.

NOTE: All other specifications are the same as those given for the MCP-35.

DESCRIPTION

PI-35 System

Bogen Multi-Graphic Model PI-35 High-Powered Intercom utilizes the MCP35 Master Control Panel and one SBA225 Room Selector Panel. Facilities are provided for the distribution of program information from external microphones, tuner, cassette player, or other background music source.

SI-35 System

Bogen Multi-Graphic Model SI-35 Desk-Top Control Center incorporates the MCP35 Master Control Panel, and has a capacity of 75 speaker stations when configured with three SBA225 Room Selector Panels. If a built-in program source is desired, an FM/AM tuner can be incorporated with one or two switchbanks; an FM/AM tuner with cassette player can be used with one switchbank.

Calls from a speaker-equipped location in an PI-35 or SI-35 system, and speaker or staff handset in a Series 115 system, are received with light annunciation and a tone signal. When selected for intercom, or when a speaker station is monitored from the control center, a supervisory tone is repeated at regular intervals. Stations equipped with a CA-16 Call-In Switch can prevent monitoring and still hear incoming messages when the switch is placed in the PRIVACY mode.

ASSOCIATED EQUIPMENT

SWITCHBANKS

Bogen Model SBA225 Room Selector Panels are capable of connecting up to 25 speaker-equipped locations to a PROGRAM, OFF, or INTERCOM channel. Each unit provides 25 lever-action, three-position, four-pole selector switches with positive detents, and red LEDs.

Switch positions are graphically identified as PROGRAM A, OFF 0, and INTERCOM C, each with color-coded indicia; the program channel color-code is amber, the off position color-code is black, and the intercom channel color-code is green.

Each switch functions as follows:

A-(Up position, amber color-code)-connects a speaker station to the Program channel for distribution of microphone, tuner, cassette player, or phono generated information; is overridden by EMERGENCY PAGE.

0-(Center position, black color-code)-disconnects a speaker station from the system; is overridden by EMERGENCY PAGE and ALL ROOMS pushbuttons.

C-(Down position, green color-code)-connects a speaker station to the Intercom channel; is overridden by EMERGENCY PAGE pushbutton. Program information will not be distributed to this station if the switch is left in this position.

A white tabular strip, protected by a clear plastic snap-off cover, is provided for labelling the station controlled by each selector switch. When stations are identified by numbers, it is common practice to connect and label the switches from left to right (as viewed from the front or operator's position), starting at the uppermost switchbank.

Calls from staff stations are initiated by momentary depression of a call-origination switch, which lights the corresponding LED on the SBA225, while sounding a repetitive tone to bring attention to the call. The LED remains "on" until the call is acknowledged by placing the appropriate switch to the "C" position.

Each switchbank panel has provisions for accommodating the add-on Bogen Model TZMA Time Zone Module, providing up to six zones of time signalling, and/or the Model SCR25 Call-In Module, providing the circuits necessary when using call-origination switches which do not contain silicon-controlled rectifiers.

SWITCHBANK MODULES

SCR25 Call-In Module

Bogen Model SCR25 Call-In Module is an annunciator latching control bank designed for use with the SBA225 Room Selector Panel. The SCR25 provides 25 silicon-controlled rectifiers and programmable DIP switches and permits the use of a momentary switch (such as the Bogen Model CA-17) and/or a telephone handset with fixed closure for call-in from a staff location.

The silicon-controlled rectifiers provide annunciator latching, keeping the appropriate LED annunciator lamp illuminated until the call is acknowledged. DIP switches are provided to select the method of call-in (momentary switch and/or fixed closure handset).

The module is connected to the switchbank panel by a simple plug-in method and is constructed of G-10 glass epoxy. Termination is via wire wrap or centerline connectors (Panduit or equivalent).

TZMA Time Zone Module

Bogen Model TZMA Time Zone Module is designed for use with the SBA225 Room Selector and Annunciator Panel. The module provides 25 six-position DIP switches and allows each staff station circuit to be programmed to any of six time zones for time signalling. Sealed relays, capable of handling 25 watts of audio power, are used to ensure trouble-free operation.

The module is connected to the switchbank panel by a simple plug-in method and is constructed of G-10 glass epoxy. Termination is via wire-wrap or centerline connectors (Panduit or equivalent).

STAFF STATION EQUIPMENT

Staff station equipment may include wall- or ceiling-mounted cone loudspeakers, or horn-type loudspeakers used to assure clear, intelligible communications in relatively high-noise areas. Staff stations reply hands-free when called. To initiate calls, locations are provided with call/emergency switches, or voice call-in, when equipped with a customer-supplied SPDT momentary switch. Staff handsets can be used in a Series 115 configuration and do not require any wiring modification; a switch has been provided on the SBA225 Room Selector and Annunciator Panel for quick conversion.

Call/Emergency Switches

Voice Call-In Option-a customer-supplied single-pole, double-throw, momentary contact switch may be used to connect a staff station speaker to the call-in line while the switch is actuated (see Figure 6).

CA-15 and CA-16-Models CA-15 and CA-16 Call/Emergency Switches, are momentary, rocker-type used to signal an administrator or control center operator to establish communications through a two-way speaker. CA-16 incorporates a PRIVACY mode to prevent monitoring.

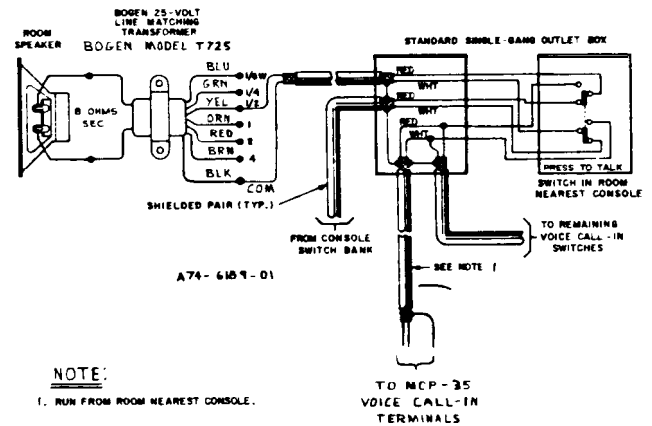

Figure 6-Connection Diagram: Room Speakers with Customer-Supplied Voice Call-In Switch

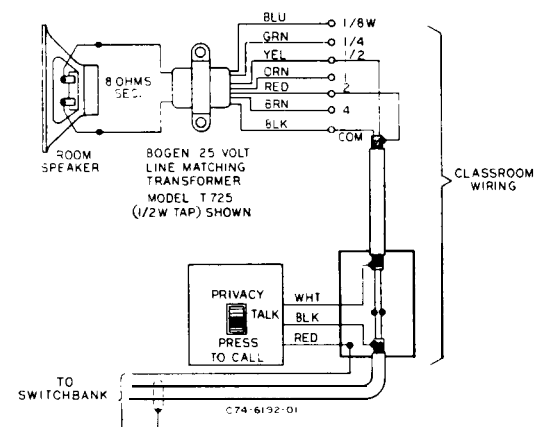
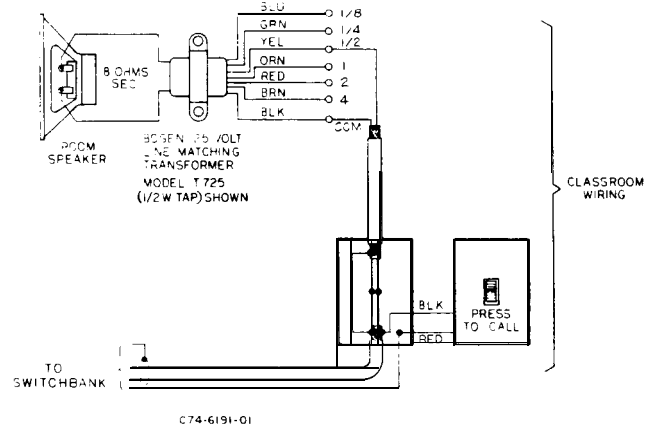
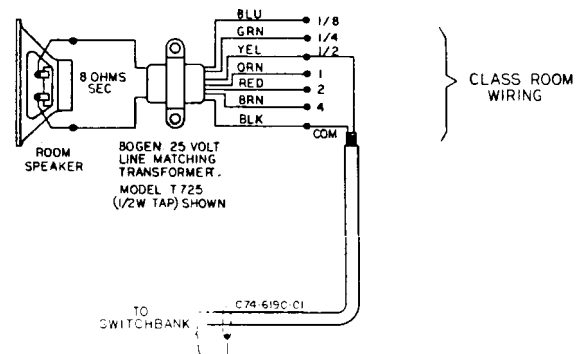

Figure 6-I-Wiring Diagram: A. Loudspeaker (Only); B. Model CA-15; C. CA-16

APPENDIX

GENERAL WIRING

Where possible, locate the control center centrally, relative to the rooms being served, in order to minimize the length of speaker cables. It is advisable that the unit be so oriented that the operator, program director, or other interested parties are able to observe the controls at all times. Provide adequate lighting and ventilation. Do not locate the control center close to heat sources, such as radiators or warm-air ducts, or against a wall which would inhibit air flow through and around it.

Wires-Class II wiring may be used for all audio and annunciator lines. Make certain to properly support cables to prevent sagging or strain. Keep wires clear of objects which would subject them to heat, friction, or other abuse.

Use No. 18 AWG shielded pairs with insulated outer jacket for speaker lines. Annunciator lines require a third wire, which usually is No. 18 AWG insulated wire with clear insulation. The number and type of wire running from each room to the control center are dependent upon the type of speaker operation required. Refer to Table I for suggestions.

Call Switches and Speakers

Outlet Boxes-Flush-mounted switches require single-gang outlet boxes; make certain to place them in a location which will allow personnel to readily access the switch for call-in and/or communicating via the room speaker. Suggested height (above finished floor) for installation of switches is about four feet; speakers should be placed at a height of about seven and one-half feet.

Soldering Instructions

Solder-Do not use acid-core solder or acid paste. Make all solder connections with standard 60/40 resin-core radio solder. Do not apply excessive heat; soldering irons or guns rated from 75 to 200 watts provide ample capacity.

Grounds-Do not connect cable shields to earth grounds or convenient metal objects. It is important to connect cable shields only as shown in the wiring diagrams.

STATION WIRING

CAUTION

Make certain to connect all wires according to color-codes given in the appropriate diagram.

Series CA- switches are designed for flush-mounting in a standard single-gang electrical outlet box, or for surface mounting in a standard deep single-gang wire mold outlet box. Locate the box to allow personnel convenient access to the switch for call-in and/or communicating via the room speaker.

CONTROL CENTER WIRING

Remove the rear panel to access the switchbank terminals. A row of male centerline terminals is located across the rear of each switchbank; an individual selector switch corresponds to the four terminals directly behind it.

Switchbank Wiring

Wire switchbanks as shown in Figure 5, using one female centerline plug (Bogen Model Number 25-18, Panduit or equivalent. Centerline plugs are also available in #20 and #22, Bogen Model Numbers 25-20 and 25-22) to terminate wires from speaker and/or call switch; connect shield to the ground terminal. **This is the only place where speaker shields should be grounded.**

Voice Call-In Option

Figure 6 shows room connections and the customer-supplied switch required for voice call-in. The wiring must be completed by connecting the shielded pair from the switch to the terminal strip at the rear of the MCP35 chassis. The polarity of the inner conductors is not critical, but make certain to connect this cable shield to the shield of the cable already connected to the terminal strip.

Note that only one cable goes to the terminal strip. Usually, cables from all room switches utilizing this function are connected by a common control cable, and one cable is run to the control center. If this type of installation is not practical, the control cables for two or more switches are run to the control center and are connected in parallel at a junction box; a single control cable is then run to the terminal strip at the rear of the MCP35 chassis.

Call/Privacy Option

Figure 7 shows the room connections and switch required for incorporating the optional privacy feature in the system.

MAINTENANCE

CAUTION

There are no user-replaceable parts within the unit. Have all internal servicing done by a qualified technician. The warranty will become void if repairs are made by other than the Bogen Service Department or an authorized service agency.

BOGEN SERVICE

Our Service Department is interested in the maintenance of your Bogen equipment. In the event of any difficulty, do not hesitate to ask our advice or assistance. Information may be obtained by writing to: Service Department, Bogen, A Lear Siegler Company, P.O. Box 575, Ramsey, NJ 07446.

When communicating with us, give the model and series designation of your unit, describe the difficulty and include details on the electrical connections to associated equipment, such as amplifiers, speakers, etc. We will send you information if the remedy appears simple. If service is required, we will send you the name and address of the nearest authorized Bogen Service Agency.

When shipping your unit, pack it well, using the original shipping carton or a similar container and filler material to prevent damage in transit. Send the unit, fully insured and prepaid, via UPS or any responsible carrier. It will be returned to you freight prepaid while in warranty.

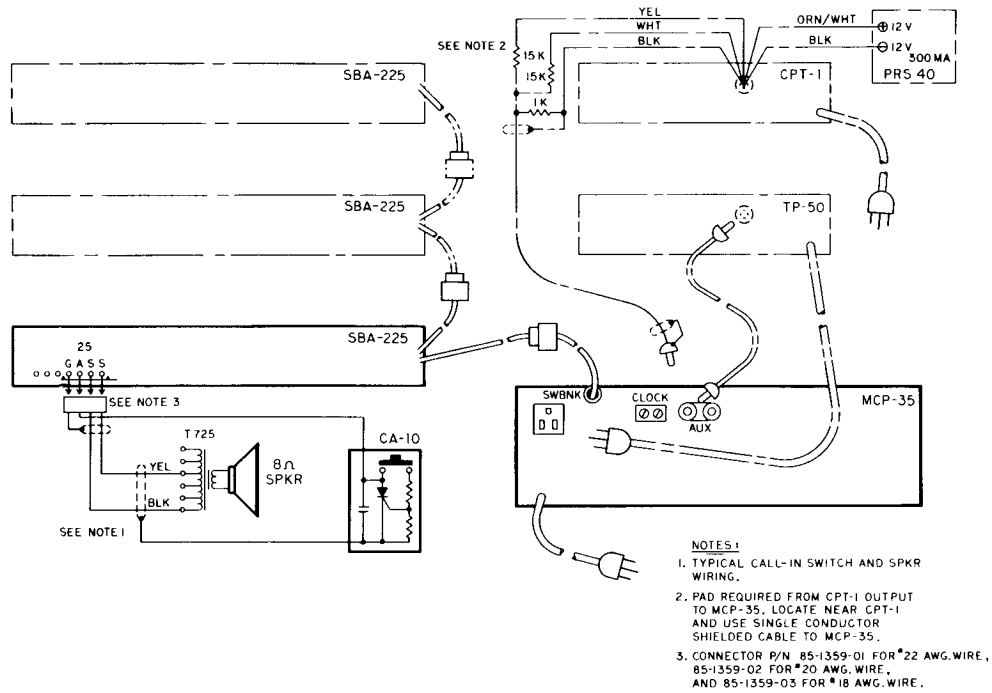

Figure 8 PI-35/SI-35 Interconnection Diagram

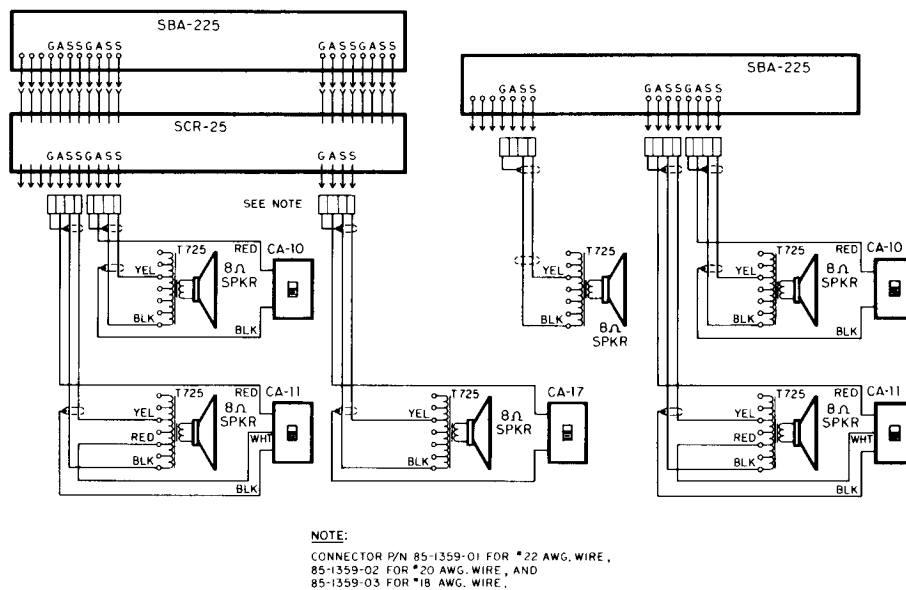

Figure 9 PI-35/SI-35 Typical Wiring Diagram

Table I—Possible MCP35/PI-35/SI-35 System Configurations

	MCP-35	SBA-225	TP-50	CPT-1	PRS-40	1-3/4" Blank Panel	3-1/2" Blank Panel
PI-35	1	1					
SI-35	1	1					1
SI-35	1	2				1	
SI-35	1	3					
SI-35	1	1	1			1	
SI-35	1	2	1				
SI-35	1	1		1	1		

531 #11
Table II-Cable Running Chart

Type of Call Switch or Device Used with Speaker	Wires from Room to Control Center		Wires from Room Switch to Room Speaker	
	No. 18 AWG Shielded	No. 18 AWG	No. 18 AWG	Refer to
Voice Call-In, Non-Private (customer-supplied SPDT momentary switch)	2*	0	1	6
None (loudspeaker only)	1	0	0	7A
Call Switch (CA-15)	1	1	1	7B
Call Switch, Privacy (CA-16)	1	1	1	7c

*Alternate Method: Run two cables from room nearest the control center and one cable from each remaining room. Run one cable in a loop or branch circuit connecting all room switches.

REPLACING COMPONENTS

CAUTION

Improper soldering may damage components or the printed circuit board. Such damage can void the warranty.

Many semiconductor components are soldered in place to ensure maximum reliability. When soldering transistors or diodes, use a heat sink (such as a small alligator clip) between the component and the source of heat. Unless you are experienced in the removal of IC micromodules, do not attempt to remove them, since excessive heat can damage an IC and/or the printed circuit board. If you are certain that an IC is defective, the easiest method of removal is to cut the leads off close to the component and desolder the leads individually. If you are not certain an IC is defective, the use of a low-wattage, vacuum-type desoldering tool (such as Ungar Type 7800) is advised.

REPLACEMENT PARTS

Most components are standard parts available through reputable parts suppliers. The parts listed herein may be obtained directly from the factory. When ordering a part, specify the part number as listed, the model number of the unit, and give the series designation, which is a letter followed by numbers, printed on the chassis. For parts on the circuit boards, also give the component board assembly number, which begins with "45".

Schematic Designation	Part Number	Description
------------------------------	--------------------	--------------------

PC Board

-	45-7267-05	P.C. Board Ass'y.
C2,38,39,89	79-008-036	Cap., Elect., 47 μF, 16V
C3,6-8,15,16, 21,22,27, 28,40,43,47	79-008-031	Cap., Elect., 10 μF, 16V
C14,26,58,61, 70,76,79,86	79-008-024	Cap., Elect., 22 μF, 16V
C49,50,52-54, 57	79-008-042	Cap., Elect., 1.0μF, .25V
C59,67,78,83	79-008-053	Cap., Elect., 100μF, 35V
C65,66,82,85	79-123-001	Cap., Elect., 1000 μF, 35V
C71,73,88,101	79-008-033	Cap., Elect., 2.2 μF, 16V
C94,95	79-008-057	Cap., Elect., 47 μF, 50V

Schematic Designation	Part Number	Description
CR2-18,20,22, 23,27-29	96-5430-01	Diode, IN4148
CR19,24	96-5333-01	Diode, 400 prv @ 1A
CR21	96-5202-01,	
	or 96-5202-02	Triple Diode, HVR-3
IC1,2	96-5648-01	IC, CA3280E
IC3	96-5656-01	IC, CD4069CN
IC4,5,7,8	96-5649-01	IC, LM1875T
IC6	96-5455-01	IC, CD4093BE
IC9	96-5441-01	IC, LM340T15
IC10	96-5474-01	IC, μ A7915C
K1,2	90-0202-01	Relay, DPDT, 12VDC
L1,2,11-21	95-521 1-01	Choke, Wide Band
LED1,3	96-5576-02	LED, Yellow
LED2,5	96-5576-03	LED, Green
LED4	96-5576-01	LED, Red
Q1,3,7-9,11, 16	96-5528-01	Transistor, 2N3906
Q2,4-6,10, 13-15	96-5527-01	Transistor, 2N3904
Q12	96-5647-01	Transistor, 2N6107
R9,19,28,31, 40,58,60,87, 88,123	77-007-004	Trimpot, 100 kilohms
R65,69,101, 105,109	76-147-087	Resistor, 1 ohm, 1/4W, 5%
R126,127	76-114-098	Resistor, .47 ohms, SW, w/w 10%
R128,129	76-114-109	Resistor, 3.3 ohms, 5W, w/w 10%
R38,56	77-001-837	Control, 100 kilohms, Audio Taper with Mtg. Hrdwr.
SI-8	81-004-109	Pushbutton Switch & Knob Ass'y.

Chassis

C201,202	79-124-001	Cap., Elect., 4700 μF, 50V
CR101	96-5650-01	Bridge Rectifier
F101	94-0003-02	Fuse, 1A
T101	83-836-000	Transformer, Power
-	93-0062-01	Speaker, 8 ohms
-	85-1344-01	Switchbank Cable Ass'y.
-	85-1345-01	Jack Ass'y.
-	93-5017-01	Console MIC Ass'y.
-	93-5016-01	Microphone
-	03-0682-01	Knob, Green
-	03-0682-02	Knob, Yellow