

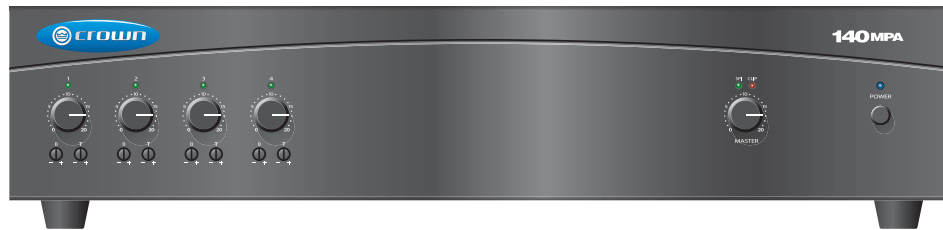

## Commercial Audio Series

Operation Manual



140MPA

**Obtaining Other Language Versions:** To obtain information in another language about the use of this product, please contact your local Crown Distributor. If you need assistance locating your local distributor, please contact Crown at 574-294-8000.

This manual does not include all of the details of design, production, or variations of the equipment. Nor does it cover every possible situation which may arise during installation, operation or maintenance.

The information provided in this manual was deemed accurate as of the publication date. However, updates to this information may have occurred. To obtain the latest version of this manual, please visit the Crown website at [www.crownaudio.com](http://www.crownaudio.com).

**Trademark Notice:** Crown, Crown Audio and Amcron are registered trademarks of Crown International. Other trademarks are the property of their respective owners.

**Some models may be exported under the name Amcron.®**

©2006 by Crown Audio® Inc., 1718 W. Mishawaka Rd., Elkhart, Indiana 46517-9439 U.S.A. Telephone: 574-294-8200

**H** A Harman International Company

139431-2  
8/06

## Important Safety Instructions

- 1) Read these instructions.
- 2) Keep these instructions.
- 3) Heed all warnings.
- 4) Follow all instructions.
- 5) Do not use this apparatus near water.
- 6) Clean only with a dry cloth.
- 7) Do not block any ventilation openings. Install in accordance with the manufacturer's instructions.
- 8) Do not install near any heat sources such as radiators, heat registers, stoves, or other apparatus (including amplifiers) that produce heat.
- 9) Do not defeat the safety purpose of the polarized or grounding-type plug. A polarized plug has two blades with one wider than the other. A grounding-type plug has two blades and a third grounding prong. The wide blade or the third prong is provided for your safety. If the provided plug does not fit into your outlet, consult an electrician for replacement of the obsolete outlet.
- 10) Protect the power cord from being walked on or pinched, particularly at plugs, convenience receptacles, and the point where they exit from the apparatus.
- 11) Only use attachments/accessories specified by the manufacturer.
- 12) Use only with a cart, stand, tripod, bracket, or table specified by the manufacturer, or sold with the apparatus. When a cart is used, use caution when moving the cart/apparatus combination to avoid injury from tip-over.
- 13) Unplug this apparatus during lightning storms or when unused for long periods of time.
- 14) Refer all servicing to qualified service personnel. Servicing is required when the apparatus has been damaged in any way, such as power-supply cord or plug is damaged, liquid has been spilled or objects have fallen into the apparatus, the apparatus has been exposed to rain or moisture, does not operate normally, or has been dropped.



- 15) WARNING: TO REDUCE THE RISK OF FIRE OR ELECTRIC SHOCK, DO NOT EXPOSE THIS APPARATUS TO RAIN OR MOISTURE.
- 16) DO NOT EXPOSE TO DRIPPING OR SPLASHING. DO NOT PLACE OBJECTS FILLED WITH LIQUID, SUCH AS VASES, ON THIS APPARATUS.

TO COMPLETELY DISCONNECT THIS EQUIPMENT FROM THE AC MAINS, DISCONNECT THE POWER SUPPLY CORD PLUG FROM THE AC RECEPTACLE. THE MAINS PLUG OF THE POWER SUPPLY CORD SHALL REMAIN READILY OPERABLE.

TO PREVENT ELECTRIC SHOCK DO NOT REMOVE TOP OR BOTTOM COVERS. NO USER SERVICEABLE PARTS INSIDE. REFER SERVICING TO QUALIFIED SERVICE PERSONNEL.

À PRÉVENIR LE CHOC ÉLECTRIQUE N'ENLEVEZ PAS LES COUVERCLES. IL N'Y A PAS DES PARTIES SERVICEABLE À L'INTÉRIEUR. TOUTS RÉPARATIONS DOIT ÊTRE FAIRE PAR PERSONNEL QUALIFIÉ SEULEMENT.

### WATCH FOR THESE SYMBOLS:

The lightning bolt triangle is used to alert the user to the risk of electric shock.

The exclamation point triangle is used to alert the user to important operating or maintenance instructions.

### IMPORTANT

Commercial Audio Series mixer-amplifiers require Class 2 output wiring.



### MAGNETIC FIELD

CAUTION! Do not locate sensitive high-gain equipment such as preamplifiers or tape decks directly above or below the unit. Because this amplifier has a high power density, it has a strong magnetic field which can induce hum into unshielded devices that are located nearby. The field is strongest just above and below the unit.

If an equipment rack is used, we recommend locating the amplifier(s) in the bottom of the rack and the preamplifier or other sensitive equipment at the top.

**CAUTION**  
RISK OF ELECTRIC SHOCK  
DO NOT OPEN

**AVIS**  
RISQUE DE CHOC ÉLECTRIQUE  
N'OUVREZ PAS

### FCC COMPLIANCE NOTICE

This device complies with part 15 of the FCC rules. Operation is subject to the following two conditions: (1) This device may not cause harmful interference, and (2) this device must accept any interference received, including interference that may cause undesired operation.

CAUTION: Changes or modifications not expressly approved by the party responsible for compliance could void the user's authority to operate the equipment.

NOTE: This equipment has been tested and found to comply with the limits for a Class B digital device, pursuant to part 15 of the FCC Rules. These limits are designed to provide reasonable protection against harmful interference in a residential installation. This equipment generates, uses, and can radiate radio frequency energy and, if not installed and used in accordance with the instruction manual, may cause harmful interference to radio communications. However, there is no guarantee that interference will not occur in a particular installation. If this equipment does cause harmful interference to radio or television reception, which can be determined by turning the equipment off and on, the user is encouraged to try to correct the interference by one or more of the following measures:

- Reorient or relocate the receiving antenna.
- Increase the separation between the equipment and receiver.
- Connect the equipment into an outlet on a circuit different from that to which the receiver is connected.
- Consult the dealer or an experienced radio/TV technician for help.





<p><b>Crown International, Inc.</b></p>	<p><b>DECLARATION of CONFORMITY</b></p>	
<p><b>Issued By:</b> Crown International, Inc. 1718 W. Mishawaka Road Elkhart, Indiana 46517 U.S.A.</p>	<p>FOR COMPLIANCE QUESTIONS ONLY:</p>	<p>Sue Whitfield 574-294-8289 swhitfield@crowintl.com</p>
<p><b>European Representative's Name and Address:</b> Nick Owen 35, Bassets Field Thornhill Cardiff, South Glamorgan CF14 9UG United Kingdom</p> <p><b>Equipment Type:</b> Commercial Audio Mixer-Amplifiers <b>Family Name:</b> Mixer-Amplifiers <b>Model Names:</b> 140MPA</p> <p><b>EMC Standards:</b></p> <ul style="list-style-type: none"> <li><b>EN 55103-1:1997</b> Electromagnetic Compatibility - Product Family Standard for Audio, Video, Audio-Visual and Entertainment Lighting Control Apparatus for Professional Use, Part 1: Emissions</li> <li><b>EN 55103-1:1997</b> Magnetic Field Emissions-Annex A @ 10 cm and 1 M</li> <li><b>EN 61000-3-2:2001</b> Limits for Harmonic Current Emissions (equipment input current 16A per phase)</li> <li><b>EN 61000-3-3:2002</b> Limitation of Voltage Fluctuations and Flicker in Low-Voltage Supply Systems Rated Current 16A</li> <li><b>EN 55022:2003</b> Limits and Methods of Measurement of Radio Disturbance Characteristics of ITE: Radiated, Class B Limits; Conducted, Class B</li> <li><b>EN 55103-2:1997</b> Electromagnetic Compatibility - Product Family Standard for Audio, Video, Audio-Visual and Entertainment Lighting Control Apparatus for Professional Use, Part 2: Immunity</li> <li><b>EN 61000-4-2:2001</b> Electrostatic Discharge Immunity (Environment E2-Criteria B, 4k V Contact, 8k V Air Discharge)</li> <li><b>EN 61000-4-3:2001</b> Radiated, Radio-Frequency, Electromagnetic Immunity (Environment E2, Criteria A)</li> <li><b>EN 61000-4-4:2001</b> Electrical Fast Transient/Burst Immunity (Criteria B)</li> <li><b>EN 61000-4-5:2001</b> Surge Immunity (Criteria B)</li> <li><b>EN 61000-4-6:2003</b> Immunity to Conducted Disturbances Induced by Radio-Frequency Fields (Criteria A)</li> <li><b>EN 61000-4-11:2001</b> Voltage Dips, Short Interruptions and Voltage Variation</li> </ul> <p><b>Safety Standard:</b></p> <ul style="list-style-type: none"> <li><b>IEC 60065: 2002 7th Ed.</b> Safety Requirements - Audio Video and Similar Electronic Apparatus</li> <li><b>CAN/CSA-E60065-03 7th Ed.</b> Audio, Video and Similar Electronic Apparatus-Safety Requirements</li> <li><b>UL 60065 7th Ed.</b> Audio /Video and Musical Instrument Apparatus for Household, Commercial and Similar General Use.</li> </ul> <p>I certify that the product identified above conforms to the requirements of the EMC Council Directive 89/336/EEC as amended by 92/31/EEC, and the Low Voltage Directive 73/23/EES as amended by 93/68/EEC.</p> <p>Signed <u></u></p> <p style="margin-left: 100px;">Larry Coburn</p> <p style="margin-left: 150px;">Title: Senior Vice President of Manufacturing</p> <p style="text-align: right;">Date of Issue: Feb. 1, 2006</p>		

**Table of Contents**

Important Safety Instructions .....	2	<b>3 Operation .....</b>	<b>13</b>
Declaration of Conformity .....	3	3.1 Powering Up.....	13
<b>1 Welcome .....</b>	<b>5</b>	3.2 Priority Ducking .....	13
1.1 Features .....	5	3.3 Music-On-Hold.....	13
1.2 Front Panel Controls and Indicators .....	6	<b>4 Troubleshooting .....</b>	<b>14</b>
1.3 Back Panel Controls and Connectors.....	7	<b>5 Specification .....</b>	<b>15</b>
<b>2 Setup .....</b>	<b>8</b>	<b>6 Service.....</b>	<b>16</b>
2.1 Installation.....	8	6.1 Worldwide Service .....	16
2.2 How to Attach Rack Ears.....	8	6.2 US and Canada Service .....	16
2.3 Choose Input Wire and Connectors .....	9	6.2.1 Service at a US or Canada Service Center .....	16
2.4 Choose Output Wire and Connectors .....	10	6.2.2 Factory Service .....	16
2.5 Wire Your System .....	11	6.2.3 Factory Service Shipping Instructions .....	16
2.6 Phantom Power .....	11	6.2.4 Packing Instructions.....	16
2.7 Link In/Out Switch.....	11	6.2.5 Estimate Approval.....	16
2.8 Remote Volume Control.....	12	6.2.6 Payment of Non-Warranty Repairs.....	16
		<b>7 Warranty .....</b>	<b>17</b>
		Product Registration.....	19
		Crown Factory Service Information Form .....	21

## 140MPA

Minimum guaranteed power  
into 4 ohms or 25V/70V output

\*1 kHz  
Power

**40W**

\*1 kHz Power: refers to maximum power in watts at  
1 kHz with 0.5% THD.

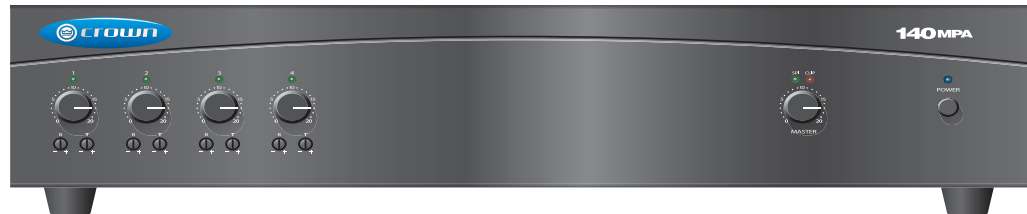

## 1 Welcome

The Crown® 140MPA is a high-value mixer-amplifier for commercial audio. It provides 4-ohm and constant-voltage outputs (25V and 70V). Typical uses are paging, background music, and music-on-hold.

The unit provides 4 inputs (each with a volume control) and a 40W amplifier output.

Other features include priority ducking, phantom power, and capability for remote volume control. Multiple units can be linked.

### 1.1 Features

- 4 inputs (each with a volume control), one 40W amplifier output channel
- Ideal for paging, background music, and music-on-hold
- Balanced Phoenix-type mic/line inputs, telephone input, dual RCA stereo music inputs, touch-proof screw-terminal speaker outputs
- Priority ducking
- Independent bass and treble controls for each input
- Three-Year, No-Fault, Fully Transferable Warranty completely protects your investment and guarantees its specifications

# 1 Welcome

## 1.2 Front Panel Controls and Indicators

**A. Input Signal Presence Indicator:** Green LED, one for each input channel, illuminates when input signal exceeds  $-40$  dBu.

**B. Input Volume Controls:** Four controls, one per input. Detented potentiometers with knobs.

**C. Master Output Volume Control:** Detented potentiometer with knob.

**D. Output Signal Presence Indicator:** Green LED illuminates when output signal level exceeds  $100$  mV ( $45$  dB below full power) from the  $4$ -ohm tap.

**E. Clip Indicator:** Red LED on output illuminates at threshold of audible distortion.

**F. Power Indicator:** Blue LED indicates power on.

**G., H. Tone Controls:** Bass and Treble non-detented recessed potentiometer on each input channel. Bass  $\pm 10$  dB at  $100$  Hz, Treble  $\pm 10$  dB at  $10$  kHz.

**I. Power Switch:** Pushbutton on-off switch.

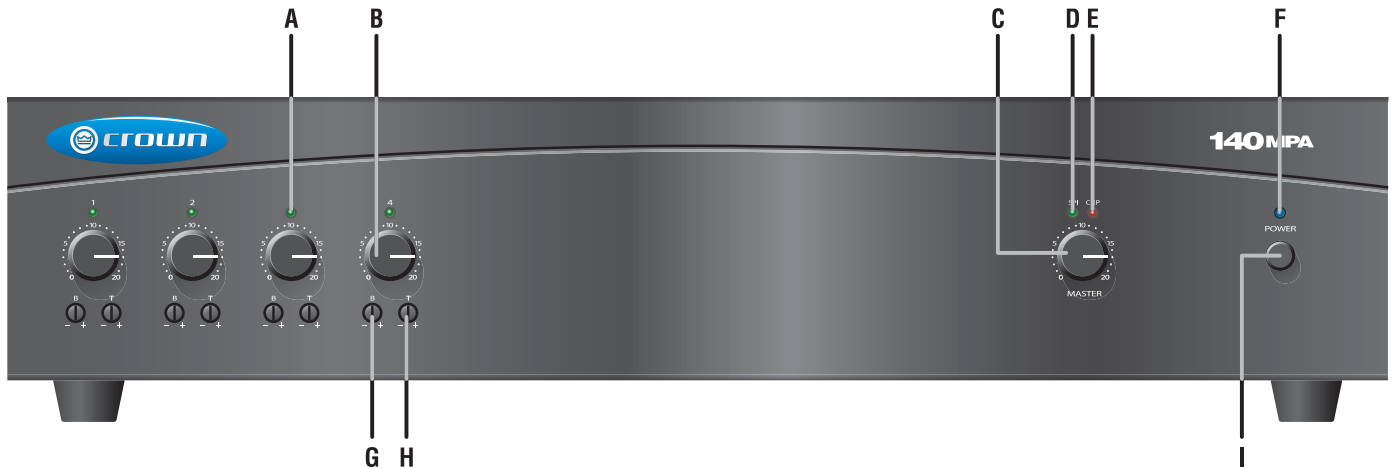

Figure 1.1 Front Panel Controls and Indicators

# 1 Welcome

## 1.3 Back Panel Controls, Connectors and Indicators

**J. Reset Switch:** Resets the circuit breaker that protects the power supply.

**K. Amplifier Output Connector:** 4-position terminal strip with COM (Common), 4 ohms, 25V and 70V terminals. Accepts up to 10 AWG terminal forks. Non-touch cover included.

**L. Preamp Line Out Connector:** 3-pin balanced Phoenix-type connector. Post master, pre-VCA. Level controlled by master volume control.

**M. Link In/Out Switch:** Slide switch. When set to IN, any signal applied to the Amp Input connector will be mixed with the input signal(s). When set to OUT, only the signal from the Amp Input Connector will appear at the amplifier output.

**N. Amp Input Connector:** 3-pin Phoenix-type, high-impedance balanced. Used to link an additional mixer to the mixer-amplifier. Can be used to connect an external processor.

**O. Output VCA Connector:** 4-pin Phoenix-type connector for two VCA control lines of +10 VDC and ground. Compatible with Crown 1-VCA module.

## P. Music-On-Hold Section

**MOH 1V Level Control:** Trim pot adjusts level for Music-On-Hold 1V output.

**MOH 1W Level Control:** Trim pot adjusts level for Music-On-Hold 1W output.

**MOH SPI Indicator:** Flashes when MOH signal is present.

**MOH 1V Phoenix Connector:** 3-pin Phoenix connector for 1V, 600-ohm transformer-isolated output.

**MOH 1W Phoenix Connector:** 3-pin Phoenix connector for 1W output.

**MOH 1V RCA Connector:** Two mono RCA connectors for 1V output (in parallel with 600-ohm connections so they are isolated).

## Q. Input 4 Section

**Balanced Input Connector:** Detachable 3-pin Phoenix style connector for balanced line-level signals, one per input channel.

**Dual RCA Input Connector:** For stereo music signals, unbalanced, summed together, two connectors per input channel.

## R. Input 3 Section

Same as Input 4 Section.

## S. Input 2 Section

Same as Input 4 Section.

## T. Input 1 Section

**Balanced Input Connector:** Detachable 3-pin Phoenix style connector for balanced mic-level or line-level signals.

**Dual RCA Input Connector:** For stereo music signals, unbalanced, summed together.

**Mic/line Switch:** Selects mic-level or line-level signal for Input 1.

**Phantom Power Switch:** Turns phantom power on or off for Input 1.

**Tel Connector:** Transformer-isolated 600-ohm input connector, summed into Input 1 for paging from a telephone system.

**U. AC Power Inlet:** Detachable IEC.

## V. Priority Section

**Active indicator:** Illuminates when VOX ducking is active.

**VOX Threshold:** Trim pot controls how loud the voice must be before ducking occurs. Can be set for no ducking.

**Priority Connector:** 3-pin Phoenix-type connector for push-to-talk mic contact closure. Input 1 is the priority input for the amplified output, so Input 1 ducks the other inputs. Threshold of activation depends on input voltage. Ducking does not affect MOH outputs.

**Priority Release:** Trim pot sets the release time of VOX ducking.

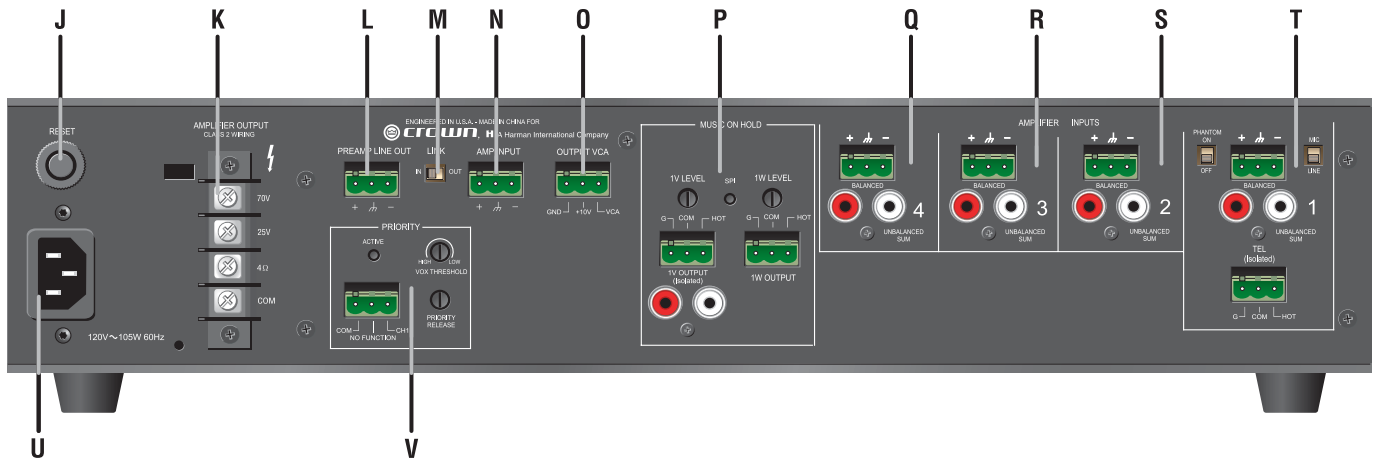

Figure 1.2 Back Panel Controls, Connectors and Indicators

## 2 Setup

### 2.1 Installation

**CAUTION:** Before you begin, make sure your mixer-amplifier is disconnected from the power source, with the power switch in the “off” position and all level controls turned completely down (counterclockwise).

Use a standard 19-inch (48.3 cm) equipment rack (EIA RS-310B). See Figure 2.1 for amplifier dimensions.

You may also stack mixer-amps without using a cabinet, or you may place a single mixer-amp on a surface with 12 inches of air space around the unit for convection cooling.

**NOTE:** When transporting in a rack, mixer-amps should be supported at the front and back.

When using an equipment rack, do not mount units directly on top of each other. Allow 2 rack units (3.5 inches) between units for convection cooling. The

side walls of the rack should be a minimum of two inches (5.1 cm) away from the mixer-amplifier sides, and the back of the rack should be a minimum of four inches (10.2 cm) from the mixer-amplifier back panel.

### 2.2 How to Attach Rack Ears

1. Locate the two rack ears and two rack-ear screws supplied.
2. See Figure 2.2. Remove the two screws from each side of the chassis near the front.
3. Place a rack ear flush with the right front of the chassis.
4. Insert a screw that you removed into the bottom hole of the rack ear and chassis. Screw it in.
5. Insert a screw that you removed into the center hole of the rack ear and chassis. Screw it in.
6. Insert one of the supplied screws into the top hole of the rack ear and chassis. Screw it in.
7. Repeat steps 3-6 for the left side of the chassis.

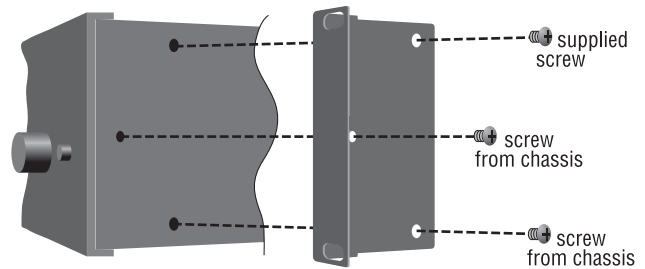

Figure 2.2 How to Connect Rack Ears

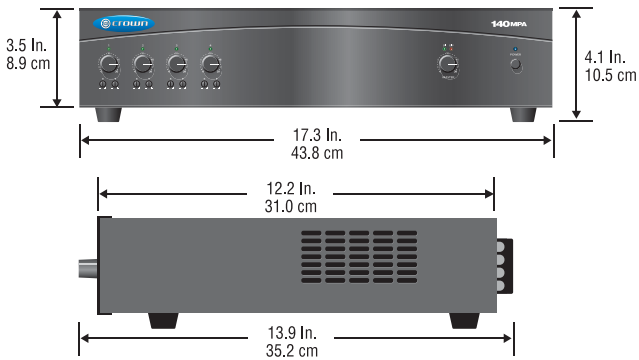

Figure 2.1 Dimensions



## 2 Setup

### 2.3 Choose Input Wire and Connectors

Crown recommends using pre-built or professionally wired balanced line (two-conductor plus shield), 22-24 gauge cables and connectors. Unbalanced line may also be used but may result in noise over long cable runs.

The 140MPA has two types of input connectors: Phoenix-type and RCA.

- **Mic/Line Connectors and Amp Input Connectors:** 3-pin Phoenix-type, balanced, one per input channel (Figure 2.3).
- **Dual RCA Input Connector:** For stereo music signals, unbalanced, summed together, two connectors per input (Figure 2.4).
- **Transformer-isolated 600-ohm input:** 3-pin Phoenix-type. Summed into Input 1 for paging from a telephone system. See Figure 2.5.

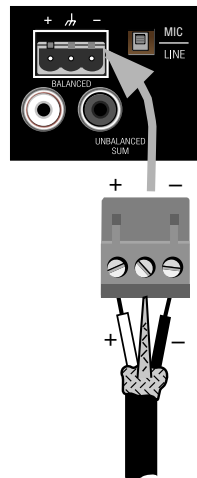

To mic or line-level source

Figure 2.3 Mic/Line Connectors and Amp Input Connectors

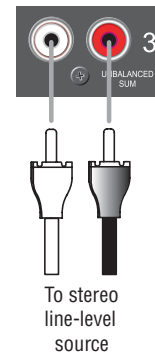
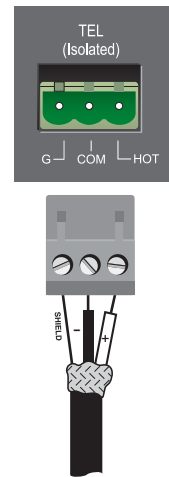

Figure 2.4 Dual RCA Input Connectors



To telephone system interface/PBX output

Figure 2.5 Tel (Isolated) Connector Wiring from Telephone System Interface or PBX

## 2 Setup

### 2.4 Choose Output Wire and Connectors

**Amplifier Output Connections:** Slip the cable lugs under the output screw terminals and tighten (Figure 2.6). Cover the output connections with the supplied non-touch cover.

Crown recommends using pre-built or professionally wired, high-quality, two-conductor, heavy gauge speaker wire and connectors. You may use crimp-on spade lugs for your output connectors. To prevent the possibility of short-circuits, wrap or otherwise insulate exposed loudspeaker cable connectors. Cover the output connections with the supplied non-touch cover.

Using the guidelines below, select the appropriate size of wire based on the distance from amplifier to speaker. The wire sizes apply to the 4-ohm tap.

Distance	Wire Size
up to 25 ft.	16 AWG
26-40 ft.	14 AWG
41-60 ft.	12 AWG
61-100 ft.	10 AWG
101-150 ft.	8 AWG
151-250 ft.	6 AWG

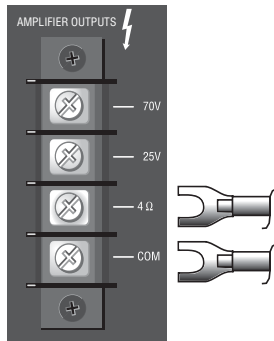

Figure 2.6 Amplifier Output Connections

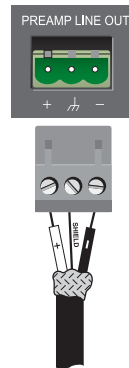
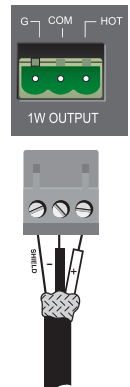

Figure 2.7 Connections to the Preamp Line Out Connector



To telephone system interface/PBX input  
Figure 2.8 Connections to the MOH Line Output Phoenix Connector (1V or 1W Connector)

**NOTE:** Custom wiring should only be performed by qualified personnel. Class 2 wiring is required.

**CAUTION:** Never use shielded cable for output power wiring.

Use 2-conductor shielded cable and a 3-pin Phoenix-type connector for Preamp Line Output (Figure 2.7), and for MOH 1V or 1W output (Figure 2.8).

Use 1-conductor shielded cable and RCA plugs for the MOH 1V Line Output RCA Connector (Figure 2.9).



#### Music-On-Hold Connections

If you have an external FM or XM tuner connected to the 140MPA, you can play its music over a phone line while the caller is on hold. Use one of the connectors below to connect the 140MPA to the Music-On-Hold input on your telephone system interface/PBX.

- **MOH 1V Line Output Phoenix Connector:** 3-pin Phoenix connector, 600-ohm transformer-isolated output, provides Music-On-Hold signal of approximately 1 volt. See Figure 2.8.
- **MOH 1W Line Output Connector:** 3-pin Phoenix connector provides Music-On-Hold signal of approximately 1 watt. See Figure 2.8.
- **MOH 1V Line Output RCA Connectors:** Two RCA connectors (mono) for 1-volt Music-On-Hold output (in parallel with 600-ohm connectors, so they are isolated). See Figure 2.9.

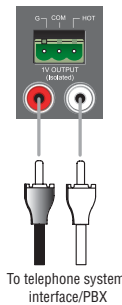

To telephone system interface/PBX  
Figure 2.9 Connections to the MOH Stereo Line Out Connector

## 2 Setup

### 2.5 Wire Your System

Typical input and output wiring is shown in Figure 2.10.

**INPUTS:** For Input 1, connect a microphone or balanced line-level signal to the Input 1 balanced input. Set the Mic/Line switch accordingly. Connect unbalanced line-level signals to the RCA input connectors.

For Inputs 2-4, connect a balanced line-level signal to the balanced input. Connect unbalanced line-level signals to the RCA input connectors.

**OUTPUTS:** Maintain proper polarity (+/-) on amplifier output connectors.

Connect the Amplifier Output screw terminals to the loudspeaker loads. Use terminals marked COM and 70V or 100V for constant-voltage loudspeaker loads. Use terminals marked COM and 4 ohms for 4-ohm speakers.

Connect the COM terminal to speaker negative (-) lead; connect one of the other terminals to speaker positive (+) lead.

### 2.6 Phantom Power

Condenser mics require phantom power to operate. If you are using a condenser microphone on Input 1, turn on the Phantom Power Switch on the back of the 140MPA. The microphone must be able to work on 15V phantom power, which the 140MPA mic input connector provides.

### 2.7 Link In/Out Switch

This switch (Figure 2.11) affects which signals are heard when another mixer is wired to the 140MPA.

**IN:** Any signal applied to the AMP INPUT connector will be mixed with the input signal(s).

**OUT:** Only the signal from the AMP INPUT connector will appear at the amplifier output.

### How to link another mixer to the 140MPA:

Connect the extra mixer's LINE OUT connector to the 140MPA AMP INPUT connector. Set the Link switch to IN.

### How to set up Music-On-Hold output:

Connect 140MPA LINE OUT to the Music-On-Hold input on a telephone system interface/PBX. Set the LINK SWITCH to IN.

### How to set up a processing loop:

Connect 140MPA LINE OUT to processor input. Connect processor output to 140MPA AMP INPUT connector. Set the Link switch to OUT.

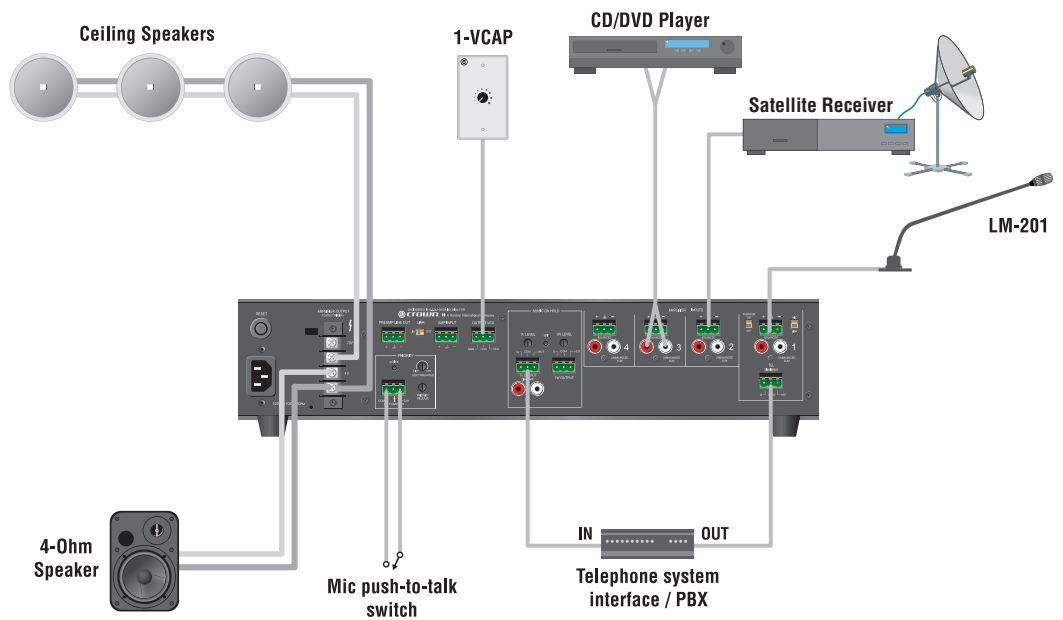

Figure 2.10 Input and Output Wiring



Figure 2.11 Link In/Out Switch

## 2 Setup

### 2.8 Remote Volume Control

You can remote-control the output volume of the 140MPA. To do so, locate the OUTPUT VCA connector on the back panel. Insert a 4-pin Phoenix-type cable connector into the OUTPUT VCA connector. Wire a Crown 1-VCAP level control to the Phoenix-type cable connector terminals as shown in Figure 2.12.

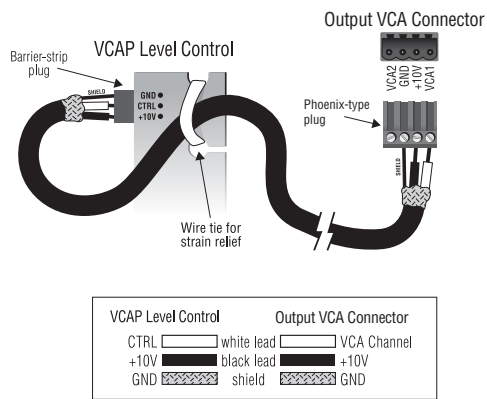

Figure 2.12 Wiring a 1-VCAP Level Control to the Output VCA Connector

## 3 Operation

### 3.1 Powering Up

1. Turn off any equipment connected to the Line Out connectors.
  2. Plug the amplifier's power cord into a 3-wire grounded AC outlet.
  3. Turn down the input volume controls.
  4. Turn down the master volume control.
  5. Turn on the Power switch. The Power indicator should glow.
  6. Turn the input volume controls in use about 3/4 up.
  7. Turn up the master volume control(s) until the desired loudness or power level is achieved.
  8. Touch up the input levels as needed for equal loudness from each microphone.
  9. Turn on any equipment connected to the Line Out connectors.
- If you ever need to make any wiring or installation changes, disconnect the power cord.

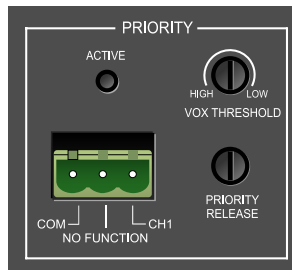

Figure 3.1 Priority Ducking Controls and Connectors

### 3.2 Priority Ducking

If you want a microphone to duck (turn down) the background music or other input signals, follow this procedure. On the back of the 140MPA,

1. Connect a push-to-talk mic contact to the **Priority Connector** (Figure 3.1). Input 1 is the priority input for the amplified output, so Input 1 ducks the other inputs. Threshold of activation depends on input voltage. Ducking does not affect MOH outputs.
2. Adjust the **VOX Threshold** trim pot on the back of the unit to set how loud the voice must be before ducking occurs. It can be set for no ducking.
3. Adjust the **Priority Release** trim pot for the desired ducking release time.

The **Active Indicator** lights when ducking is active.

### 3.3 Music-On-Hold

On the back of the unit, adjust either the 1V or 1W MOH Level Control to obtain the desired level of Music-On-Hold on your phone system.

## 4 Troubleshooting



**CONDITION: No power to the mixer-amplifier.**

**POSSIBLE REASON:**

- The mixer-amplifier's Power switch is off.
- The mixer-amplifier is not plugged into the power receptacle.
- The mixer-amplifier's high-voltage power supply circuit breaker has tripped. Verify that the AC mains voltage is correct, then press the Reset button on the back panel.



**CONDITION: Distorted sound.**

**POSSIBLE REASON:**

- Input signal level is too high. Turn down your input volume controls. **NOTE:** Your mixer-amplifier should never be operated at a level which causes the Clip LEDs to illuminate constantly.
- Master volume level is too high. Turn it down to about 3/4 of maximum level.

[NO GRAPHIC IS NEEDED HERE]

**CONDITION: No sound.**

**POSSIBLE REASON:**

- The amplifier is in "fault" mode. A Fault status can be triggered when one of the amplifier's protection circuits is activated. First disconnect your speakers from the affected channel(s) one by one to determine if one of the loads is shorted. If an amplifier channel has a thermal fault, there will be no indication on the front panel, but the amp will recover after cooling. If operation does not return to normal after restarting your amp, press the Reset button on the back of the unit. If that does not work, return the unit to Crown or an authorized Crown Service Center for servicing.

---



- No input signal.
- Input signal level is very low.

**KEY**

LED OFF 

LED ON 

## 5 Specifications

Minimum Guaranteed Power	140MPA
<b>1 kHz with 0.5% THD</b> Minimum guaranteed power into 4 ohms or 25V/70V output	40W
<b>Performance</b>	
Number of input channels	4
Number of power amplifiers	1
Input Sensitivity (volts RMS) for full output at maximum gain	
Balanced mic inputs	3 mV
Balanced line inputs	800 mV
RCA connectors	400 mV
Frequency Response (at 1 watt from 8-ohm tap, 50 Hz - 15 kHz)	± 1 dB
Frequency Response (at line out, 50 Hz to 15 kHz)	± 1 dB
Power Bandwidth (at 8-ohm tap, 2 dB below maximum 1 kHz power)	50 Hz to 20 kHz with < 0.5% THD
Signal to Noise Ratio (ref. to rated power, master volume at minimum)	> 90 dB
Total Harmonic Distortion (THD) at rated power at 1 kHz	< 0.5%
DC Output Offset	< ± 5 mV
Input Impedance (nominal)	Mic: 400 ohms, Line: 100 kilohms, RCA: 50 kilohms
Crosstalk (all controls at "10")	-70 dB at 1 kHz
Line Output Level (nominal)	1V into 10 kilohms
Phantom Power	15 VDC
AC Line Voltages Available	120V, 60 Hz Line voltage tolerance +15%, -20%
Operating Temperature/Humidity	0° C to 40° C at 95% relative humidity (non-condensing)
Storage Temperature	-20° C to 85° C
<b>Construction</b>	
Cooling	Convection cooled
Dimensions	Width without rack ears: 17.3 in. (43.8 cm) Width with rack ears: EIA Standard 19 in. W (EIA RS-310-B) Height of front panel: 3.5 in. (8.9 cm) Height including feet: 4.1 in. (10.5 cm) Depth from front panel to back panel: 12.2 in. (31.0 cm) Depth from front of knobs to back of non-touch cover: 13.9 in. (35.2 cm)
Net Weight, Shipping Weight	17 lb (7.7 kg), 22 lb (9.98 kg)

## 6 Service

Crown mixer-amplifiers are quality units that rarely require servicing. Before returning your unit for servicing, please contact Crown Technical Support to verify the need for servicing.

This unit has very sophisticated circuitry which should only be serviced by a fully trained technician. This is one reason why each unit bears the following label:

**CAUTION: To prevent electric shock, do not remove covers. No user serviceable parts inside. Refer servicing to a qualified technician.**



Complete the Crown Audio Factory Service Information form, in the back of this manual, when returning a Crown product to the factory or authorized service center. The form must be included with your product inside the box or in a packing slip envelope securely attached to the outside of the shipping carton. Do not send this form separately.

### 6.1 Worldwide Service

Service may be obtained from an authorized service center. (Contact your local Crown/Amcron representative or our office for a list of authorized service centers.) To obtain service, simply present the bill of sale as proof of purchase along with the defective unit to an authorized service center. They will handle the necessary paperwork and repair.

Remember to transport your unit in the original factory pack.

### 6.2 US and Canada Service

Service may be obtained in one of two ways: from an authorized service center or from the factory. You may choose either. It is important that you have your copy of the bill of sale as your proof of purchase.

#### 6.2.1 Service at a US or Canada Service Center

This method usually saves the most time and effort. Simply present your bill of sale along with the defective unit to an authorized service center to obtain service. They will handle the necessary paperwork and repair. Remem-

ber to transport the unit in the original factory pack. A list of authorized service centers in your area can be obtained from Crown Factory Service, or online from <http://www.crownaudio.com/support/servcent.htm>.

#### 6.2.2 Factory Service

Crown accepts no responsibility for non-serviceable product that is sent to us for factory repair. It is the owner's responsibility to ensure that their product is serviceable prior to sending it to the factory. Serviceable product list is available at <http://crownweb.crownintl.com/crownrma/>. For more information, please contact us direct.

A Service Return Authorization (SRA) is required for product being sent to the factory for repair. An SRA can be completed online at [www.crownaudio.com/support/factserv.htm](http://www.crownaudio.com/support/factserv.htm). If you do not have access to the web, please call Crown's Customer Service at 574.294.8200 or 800.342.6939 extension 8205 in North America, Puerto Rico and the Virgin Islands only.

For warranty service, we will pay for ground shipping both ways in the United States. Contact Crown Customer Service to obtain prepaid shipping labels prior to sending the unit. Or, if you prefer, you may prepay the cost of shipping, and Crown will reimburse you. Send copies of the shipping receipts to Crown to receive reimbursement.

Your repaired unit will be returned via UPS ground. Please contact us if other arrangements are required.

#### 6.2.3 Factory Service Shipping Instructions:

1. Service Return Authorization (SRA) is required for product being sent to the factory for service. Please complete the SRA by going to [www.crownaudio.com/support/factserv.htm](http://www.crownaudio.com/support/factserv.htm). If you do not have access to our website, call 1.800.342.6939, extension 8205 and we'll create the SRA for you.
2. See packing instructions that follow.
3. Ship product to:  
CROWN AUDIO FACTORY SERVICE  
1718 W MISHAWKA RD.  
ELKHART, IN 46517

4. Use a bold black marker and write the SRA number on three sides of the box.
5. Record the SRA number for future reference. The SRA number can be used to check the repair status.

#### 6.2.4 Packing Instructions

**Important:** These instructions must be followed. If they are not followed, Crown Audio, Inc. assumes no responsibility for damaged goods and/or accessories that are sent with your unit.

1. Fill out and include the Crown Audio Factory Service Information sheet in the back of this manual.
2. Do not ship any accessories (manuals, cords, hardware, etc.) with your unit. These items are not needed to service your product. We will not be responsible for these items.
3. When shipping your Crown product, it is important that it has adequate protection. We recommend you use the original pack material when returning the product for repair (Figure 9.1). If you do not have the original box, please call Crown at 800.342.6939 or 574.294.8210 and order new pack material. (Do not ship your unit in a wood or metal cabinet.)
4. If you provide your own shipping pack, the minimum recommended requirements for materials are as follows:
  - a. 275 P.S.I. burst test, Double-Wall carton that allows for 2-inch solid Styrofoam on all six sides of unit or 3 inches of plastic bubble wrap on all six sides of unit.
  - b. Securely seal the package with an adequate carton sealing tape.
  - c. Do not use light boxes or "peanuts". Damage caused by poor packaging will not be covered under warranty.

Enclose the completed Crown Audio Factory Service Information form (or securely attach it to the outside of carton) and re-seal the shipping pack with a sturdy carton sealing tape.

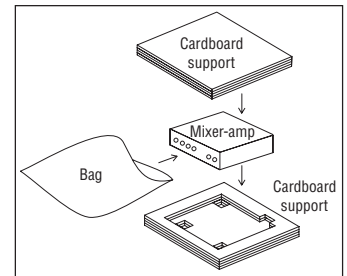

Figure 6.1 Packing.  
Put this assembly in carton.

#### 6.2.5 Estimate Approval

Approval of estimate must be given within 90 days after being notified by Crown Audio Inc. Units still in the possession of Crown after 90 days of the estimate will become the property of Crown Audio Inc.

#### 6.2.6 Payment of Non-Warranty Repairs

Payment on out-of-warranty repairs must be received within 90 days of the repair date. Units unclaimed after 90 days become the property of Crown Audio Inc.

If you have any questions, please contact Crown Factory Service.

**Crown Factory Service**  
1718 W. Mishawaka Rd.,  
Elkhart, Indiana 46517 U.S.A.

**Telephone:**  
574.294.8200  
800.342.6939 (North America,  
Puerto Rico, and Virgin Islands only)

**Facsimile:**  
574.294.8301 (Technical Support)  
574.294.8124 (Factory Service)

**Internet:**  
<http://www.crownaudio.com>



## 7 Warranty



### UNITED STATES & CANADA

#### SUMMARY OF WARRANTY

Crown International, 1718 West Mishawaka Road, Elkhart, Indiana 46517-4095 U.S.A. warrants to you, the ORIGINAL PURCHASER and ANY SUBSEQUENT OWNER of each NEW Crown product, for a period of three (3) years from the date of purchase by the original purchaser (the "warranty period") that the new Crown product is free of defects in materials and workmanship. We further warrant the new Crown product regardless of the reason for failure, except as excluded in this Warranty.

#### ITEMS EXCLUDED FROM THIS CROWN WARRANTY

This Crown Warranty is in effect only for failure of a new Crown product which occurred within the Warranty Period. It does not cover any product which has been damaged because of any intentional misuse, accident, negligence, or loss which is covered under any of your insurance contracts. This Crown Warranty also does not extend to the new Crown product if the serial number has been defaced, altered, or removed.

#### WHAT THE WARRANTOR WILL DO

We will remedy any defect, regardless of the reason for failure (except as excluded), by repair, replacement, or refund. We may not elect refund unless you agree, or unless we are unable to provide replacement, and repair is not practical or cannot be timely made. If a refund is elected, then you must make the defective or malfunctioning product available to us free and clear of all liens or other encumbrances. The refund will be equal to the actual purchase price, not including inter-

est, insurance, closing costs, and other finance charges less a reasonable depreciation on the product from the date of original purchase. Warranty work can only be performed at our authorized service centers or at the factory. Warranty work for some products can only be performed at our factory. We will remedy the defect and ship the product from the service center or our factory within a reasonable time after receipt of the defective product at our authorized service center or our factory. All expenses in remedying the defect, including surface shipping costs in the United States, will be borne by us. (You must bear the expense of shipping the product between any foreign country and the port of entry in the United States including the return shipment, and all taxes, duties, and other customs fees for such foreign shipments.)

#### HOW TO OBTAIN WARRANTY SERVICE

You must notify us of your need for warranty service within the warranty period. All components must be shipped in a factory pack, which, if needed, may be obtained from us free of charge. Corrective action will be taken within a reasonable time of the date of receipt of the defective product by us or our authorized service center. If the repairs made by us or our authorized service center are not satisfactory, notify us or our authorized service center immediately.

#### DISCLAIMER OF CONSEQUENTIAL AND INCIDENTAL DAMAGES

YOU ARE NOT ENTITLED TO RECOVER FROM US ANY INCIDENTAL DAMAGES RESULTING

FROM ANY DEFECT IN THE NEW CROWN PRODUCT. THIS INCLUDES ANY DAMAGE TO ANOTHER PRODUCT OR PRODUCTS RESULTING FROM SUCH A DEFECT. SOME STATES DO NOT ALLOW THE EXCLUSION OR LIMITATIONS OF INCIDENTAL OR CONSEQUENTIAL DAMAGES, SO THE ABOVE LIMITATION OR EXCLUSION MAY NOT APPLY TO YOU.

#### WARRANTY ALTERATIONS

No person has the authority to enlarge, amend, or modify this Crown Warranty. This Crown Warranty is not extended by the length of time which you are deprived of the use of the new Crown product. Repairs and replacement parts provided under the terms of this Crown Warranty shall carry only the unexpired portion of this Crown Warranty.

#### DESIGN CHANGES

We reserve the right to change the design of any product from time to time without notice and with no obligation to make corresponding changes in products previously manufactured.

#### LEGAL REMEDIES OF PURCHASER

THIS CROWN WARRANTY GIVES YOU SPECIFIC LEGAL RIGHTS, YOU MAY ALSO HAVE OTHER RIGHTS WHICH VARY FROM STATE TO STATE. No action to enforce this Crown Warranty shall be commenced after expiration of the warranty period.

THIS STATEMENT OF WARRANTY SUPERSEDES ANY OTHERS CONTAINED IN THIS MANUAL FOR CROWN PRODUCTS. 12/01



## 7 Warranty



### WORLDWIDE EXCEPT USA & CANADA

#### SUMMARY OF WARRANTY

Crown International, 1718 West Mishawaka Road, Elkhart, Indiana 46517-4095 U.S.A. warrants to you, the ORIGINAL PURCHASER and ANY SUBSEQUENT OWNER of each NEW Crown1 product, for a period of three (3) years from the date of purchase by the original purchaser (the "warranty period") that the new Crown product is free of defects in materials and workmanship, and we further warrant the new Crown product regardless of the reason for failure, except as excluded in this Warranty.

<sup>1</sup> Note: If your unit bears the name "Amcron," please substitute it for the name "Crown" in this warranty.

#### ITEMS EXCLUDED FROM THIS CROWN-WARRANTY

This Crown Warranty is in effect only for failure of a new Crown product which occurred within the Warranty Period. It does not cover any product which has been damaged because of any intentional misuse, accident, negligence, or loss which is covered under any of your insurance contracts. This Crown Warranty also does not extend to the new Crown product if the serial number has been defaced, altered, or removed.

#### WHAT THE WARRANTOR WILL DO

We will remedy any defect, regardless of the reason for failure (except as excluded), by repair, replacement, or refund. We may not elect refund unless you agree, or unless we are unable to provide replacement, and repair is not practical or cannot be timely made. If a refund is elected, then you must make the defective or malfunctioning product available to us free and clear of all liens or other encumbrances. The refund will be equal to the actual purchase price, not including interest, insurance, closing costs, and other finance charges less a reasonable depreciation on the product from the date of original purchase. Warranty work can only be performed at our authorized service centers. We will remedy the defect and ship the product from the service center within a reasonable time after receipt of the defective product at our authorized service center.

#### HOW TO OBTAIN WARRANTY SERVICE

You must notify your local Crown importer of your need for warranty service within the warranty period. All components must be shipped in the original box. Corrective action will be taken within a reasonable time of the date of receipt of the defective product by our authorized service center. If the repairs made by our authorized service center are not satisfactory, notify our authorized service center immediately.

#### DISCLAIMER OF CONSEQUENTIAL AND INCIDENTAL DAMAGES

YOU ARE NOT ENTITLED TO RECOVER FROM US ANY INCIDENTAL DAMAGES RESULTING FROM ANY DEFECT IN THE NEW CROWN PRODUCT. THIS INCLUDES ANY DAMAGE TO ANOTHER PRODUCT OR PRODUCTS RESULTING FROM SUCH A DEFECT.

#### WARRANTY ALTERATIONS

No person has the authority to enlarge, amend, or modify this Crown Warranty. This Crown Warranty is not extended by the length of time which you are deprived of the use of the new Crown product. Repairs and replacement parts provided under the terms of this Crown Warranty shall carry only the unexpired portion of this Crown Warranty.

#### DESIGN CHANGES

We reserve the right to change the design of any product from time to time without notice and with no obligation to make corresponding changes in products previously manufactured.

#### LEGAL REMEDIES OF PURCHASER

No action to enforce this Crown Warranty shall be commenced after expiration of the warranty period.

THIS STATEMENT OF WARRANTY SUPERSEDES ANY OTHERS CONTAINED IN THIS MANUAL FOR CROWN PRODUCTS. 7/01



# PRODUCT REGISTRATION

Crown International  
1718 W. Mishawaka Rd.  
Elkhart, IN 46517-9439  
Phone: 574-294-8000  
Fax: 574-294-8329  
www.crownaudio.com

Online registration is also available at <http://crownweb.crownintl.com/webregistration>

When this form is used to register your product, it may be mailed or faxed.

Crown International      Fax: 574-294-8329  
1718 W Mishawaka Rd  
Elkhart IN 46517

Please note that some information is required. Incomplete registrations will not be processed. \* Indicates required information.

### OWNER'S INFORMATION - PLEASE PRINT

\* First name: \_\_\_\_\_ Middle initial: \_\_\_\_\_ \* Last name: \_\_\_\_\_  
Company: \_\_\_\_\_  
\* Mailing address: \_\_\_\_\_  
\* City: \_\_\_\_\_ \* State: \_\_\_\_\_ \* Zip Code: \_\_\_\_\_  
\* Country: \_\_\_\_\_ E-mail address: \_\_\_\_\_  
\* Phone # (include area code): \_\_\_\_\_ Fax #: \_\_\_\_\_

### PRODUCT INFORMATION

* MODEL	* SERIAL #	PURCHASE DATE
ie. MA3600VZ, CE1000A, PCC160		mo/day/yr
_____	_____	____/____/____
_____	_____	____/____/____
_____	_____	____/____/____
_____	_____	____/____/____

Product purchased from: \_\_\_\_\_ City: \_\_\_\_\_ State: \_\_\_\_\_  
Comments: \_\_\_\_\_  
\_\_\_\_\_  
\_\_\_\_\_

CUT ON THIS LINE

THIS PAGE INTENTIONALLY LEFT BLANK



# Crown Audio Factory Service Information

Shipping Address: Crown Audio Factory Service, 1718 W. Mishawaka Rd., Elkhart, IN 46517

**PLEASE PRINT CLEARLY**

SRA #: \_\_\_\_\_ (If sending product to Crown factory service.)      Model: \_\_\_\_\_      Serial Number: \_\_\_\_\_      Purchase Date: \_\_\_\_\_

**PRODUCT RETURN INFORMATION**

Individual or Business Name: \_\_\_\_\_

Phone #: \_\_\_\_\_      Fax #: \_\_\_\_\_      E-Mail: \_\_\_\_\_

Street Address (please, no P.O. Boxes): \_\_\_\_\_

City: \_\_\_\_\_      State/Prov: \_\_\_\_\_      Postal Code: \_\_\_\_\_      Country: \_\_\_\_\_

Nature of problem: \_\_\_\_\_

\_\_\_\_\_

\_\_\_\_\_

Other equipment in your system: \_\_\_\_\_

If warranty is expired, please provide method of payment. Proof of purchase may be required to validate warranty.

**PAYMENT OPTIONS**

I have open account payment terms. Purchase order required. PO# \_\_\_\_\_       COD

Credit Card (Information below is required; however if you do not want to provide this information at this time, we will contact you for the information when your unit is repaired).

Credit card information:

Type of credit card:     Master Card     Visa     American Express     Discover

Type of credit card account:     Personal/Consumer     Business/Corporate

Card # \_\_\_\_\_      Exp. date: \_\_\_\_\_      \* Card ID #: \_\_\_\_\_

\* Card ID # is located on the back of the card following the credit card #, in the signature area. On American Express, it may be located on the front of the card. This number is required to process the charge to your account. If you do not want to provide it at this time, we will call you to obtain this number when the repair of your unit is complete.

Name on credit card: \_\_\_\_\_

Billing address of credit card: \_\_\_\_\_

\_\_\_\_\_

\_\_\_\_\_

THIS PAGE INTENTIONALLY LEFT BLANK

THIS PAGE INTENTIONALLY LEFT BLANK



**H** A Harman International Company