

DENON

CD PLAYER

DCD-500AE

OPERATING INSTRUCTIONS

BEDIENUNGSANLEITUNG

MODE D'EMPLOI

ISTRUZIONI PER L'USO

INSTRUCCIONES DE FUNCIONAMIENTO

GEBRUIKSAANWIJZING

BRUKSANVISNING

☐ SAFETY PRECAUTIONS



CAUTION
RISK OF ELECTRIC SHOCK
DO NOT OPEN



CAUTION:
TO REDUCE THE RISK OF ELECTRIC SHOCK, DO NOT REMOVE COVER (OR BACK). NO USER-SERVICEABLE PARTS INSIDE. REFER SERVICING TO QUALIFIED SERVICE PERSONNEL.



The lightning flash with arrowhead symbol, within an equilateral triangle, is intended to alert the user to the presence of uninsulated “dangerous voltage” within the product’s enclosure that may be of sufficient magnitude to constitute a risk of electric shock to persons.



The exclamation point within an equilateral triangle is intended to alert the user to the presence of important operating and maintenance (servicing) instructions in the literature accompanying the appliance.

WARNING:
TO REDUCE THE RISK OF FIRE OR ELECTRIC SHOCK, DO NOT EXPOSE THIS APPLIANCE TO RAIN OR MOISTURE.

CLASS 1 LASER PRODUCT
LUOKAN 1 LASERLÄITE
KLASS 1 LASERAPPARAT



ADVARSEL: USYNLIG LASERSTRÅLING VED ÅBNING, NÅR SIKKERHEDSAFBRYDERE ER UDE AF FUNKTION.

VAROITUS! UNDĞÄ UDSÆTTELSE FOR STRÅLING. LÄITTEEN KÄYTTÄMINEN MUULLA KUIN TÄSSÄ KÄYTTÖOHJEESSA MAINITULLA TAVALLA SAATTAA ALITISTAA KÄYTTÄÄN TURVALLISUUSLUOKAN 1 YLITTÄVÄLLE NÄKYMÄMÄTÖMÄLLE LASERSÄTEILYLLE.

WARNING: OM APPARATEN ANVÄNDS PÅ ANNAT SÄTT AN I DENNA BRUKSANVISNING SPECIFICERATS, KAN ANVÄNDAREN UTSÄTTAS FÖR OSYNLIG LASERSTRÅLNING SOM ÖVERSKRIDER GRÄNSEN FÖR LASERKLASS 1.

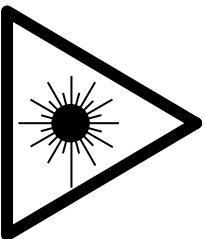

ATTENZIONE: QUESTO APPARECCHIO È DOTATO DI DISPOSITIVO OTTICO CON RAGGIO LASER. L'USO IMPROPRIO DELL'APPARECCHIO PUO' CAUSARE PERICOLOSE ESPOSIZIONI A RADIAZIONI!!

CAUTION:
USE OF CONTROLS OR ADJUSTMENTS OR PERFORMANCE OF PROCEDURES OTHER THAN THOSE SPECIFIED HEREIN MAY RESULT IN HAZARDOUS RADIATION EXPOSURE.
THIS PRODUCT SHOULD NOT BE ADJUSTED OR REPAIRED BY ANYONE EXCEPT PROPERLY QUALIFIED SERVICE PERSONNEL.

• **DECLARATION OF CONFORMITY**

We declare under our sole responsibility that this product, to which this declaration relates, is in conformity with the following standards: EN60065, EN55013, EN55020, EN61000-3-2 and EN61000-3-3. Following the provisions of 73/23/EEC, 89/336/EEC and 93/68/EEC Directive.

• **ÜBEREINSTIMMUNGSERKLÄRUNG**

Wir erklären unter unserer Verantwortung, daß dieses Produkt, auf das sich diese Erklärung bezieht, den folgenden Standards entspricht: EN60065, EN55013, EN55020, EN61000-3-2 und EN61000-3-3. Entspricht den Verordnungen der Direktive 73/23/EEC, 89/336/EEC und 93/68/EEC.

• **DECLARATION DE CONFORMITE**

Nous déclarons sous notre seule responsabilité que l'appareil, auquel se réfère cette déclaration, est conforme aux standards suivants: EN60065, EN55013, EN55020, EN61000-3-2 et EN61000-3-3. D'après les dispositions de la Directive 73/23/EEC, 89/336/EEC et 93/68/EEC.

• **DICHIARAZIONE DI CONFORMITÀ**

Dichiaro con piena responsabilità che questo prodotto, al quale la nostra dichiarazione si riferisce, è conforme alle seguenti normative: EN60065, EN55013, EN55020, EN61000-3-2 e EN61000-3-3. In conformità con le condizioni delle direttive 73/23/EEC, 89/336/EEC e 93/68/EEC. QUESTO PRODOTTO E' CONFORME AL D.M. 28/08/95 N. 548

• **DECLARACIÓN DE CONFORMIDAD**

Declaro bajo nuestra exclusiva responsabilidad que este producto al que hace referencia esta declaración, está conforme con los siguientes estándares: EN60065, EN55013, EN55020, EN61000-3-2 y EN61000-3-3. Siguiendo las provisiones de las Directivas 73/23/EEC, 89/336/EEC y 93/68/EEC.



• **EENVORMIGHEIDSVERKLARING**

Wij verklaren uitsluitend op onze verantwoordelijkheid dat dit product, waarop deze verklaring betrekking heeft, in overeenstemming is met de volgende normen: EN60065, EN55013, EN55020, EN61000-3-2 en EN61000-3-3. Volgens de bepalingen van de Richtlijnen 73/23/EEC, 89/336/EEC en 93/68/EEC.

• **ÖVERENSSTÄMMELSESINTYG**

Härmed intygas helt på eget ansvar att denna produkt, vilken detta intyg avser, uppfyller följande standarder: EN60065, EN55013, EN55020, EN61000-3-2 och EN61000-3-3. Enligt städgarna i direktiv 73/23/EEC, 89/336/EEC och 93/68/EEC.

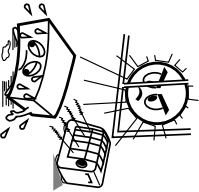
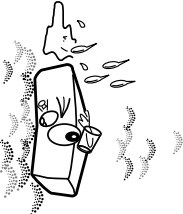
NOTE ON USE / HINWEISE ZUM GEBRAUCH / OBSERVATIONS RELATIVES A L'UTILISATION / NOTE SULL'USO / NOTAS SOBRE EL USO / ALVORENS TE GEBRUIKEN / OBSERVERERA

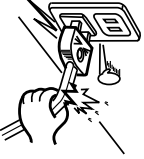
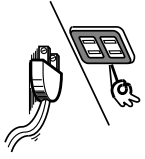
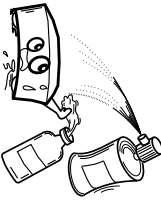
 <ul style="list-style-type: none"> • Avoid high temperatures. • Allow for sufficient heat dispersion when installed in a rack. • Vermeiden Sie hohe Temperaturen. • Beachten Sie, daß eine ausreichend Luftzirkulation gewährleistet wird, wenn das Gerät auf ein Regal gestellt wird. • Éviter des températures élevées • Tenir compte d'une dispersion de chaleur suffisante lors de l'installation sur une étagère. • Evitate di esporre l'unità a temperature alte. • Assicurarsi che ci sia un'adeguata dispersione del calore quando installate l'unità in un mobile per componenti audio. • Evite altas temperaturas. • Permita la suficiente dispersión del calor cuando está instalado en la consola. • Vermijd hoge temperaturen. • Zorg voor een degelijk hittevoer indien het apparaat op een rek wordt geplaatst. • Undvik höga temperaturer. • Se till att det finns möjlighet till god värmeavledning vid monterng i ett rack. 	 <ul style="list-style-type: none"> • Keep the apparatus free from moisture, water, and dust. • Halten Sie das Gerät von Feuchtigkeit, Wasser und Staub fern. • Protéger l'appareil contre l'humidité, l'eau et lapoussière. • Tenete l'unità lontana dall'umidità, dall'acqua e dalla polvere. • Mantenga el equipo libre de humedad, agua y polvo. • Laat geen vochtigheid, water of stof in het apparaat binnendringen. • Usätt inte apparaten för fukt, vatten och damm. 	 <ul style="list-style-type: none"> • Do not let foreign objects into the apparatus. • Keine fremden Gegenstände in das Gerät kommen lassen. • Ne pas laisser des objets étrangers dans l'appareil. • È importante che nessun oggetto è inserito all'interno dell'unità. • No dele objetos extraños dentro del equipo. • Laat geen vreemde voorwerpen in dit apparaat vallen. • No till att främmande föremål inte tränger in i apparaten. 	<p>CAUTION:</p> <ul style="list-style-type: none"> • The ventilation should not be impeded by covering the ventilation openings with items, such as newspapers, tablecloths, curtains, etc. • No naked flame sources, such as lit candles, should be placed on the apparatus. • Attention should be drawn to the environmental aspects of battery disposal. • Do not expose the set to dipping or splashing fluids. • No objects filled with liquids, such as vases, shall be placed on the apparatus. <p>ACHTUNG:</p> <ul style="list-style-type: none"> • Die Belüftung sollte auf keinen Fall durch das Abdecken der Belüftungöffnungen durch Gegenstände wie beispielsweise Zettungen, Tischtücher, Vorhänge o. Ä. behindert werden. • Auf dem Gerät sollten keinelei direkten Feuerquellen wie beispielsweise angezündete Kerzen aufgestellt werden. • Bitte beachten Sie bei der Entsorgung der Batterien die geltenden Umweltbestimmungen. • Das Gerät sollte keinerlei Flüssigkeit, also keinem Tropfen oder Spritzen ausgesetzt werden. • Auf dem Gerät sollten keinelei mit Flüssigkeit gefüllten Behälter wie beispielsweise Vasen aufgestellt werden. <p>ATTENTION:</p> <ul style="list-style-type: none"> • La ventilation ne doit pas être gênée en recouvrant les ouvertures de la ventilation avec des objets tels que journaux, rideaux, tissus, etc. • Aucune flamme nue, par exemple une bougie, ne doit être placée sur l'appareil. • Veillez à respecter l'environnement lorsque vous jetez les piles usagées. • L'appareil ne doit pas être exposé à l'eau ou à l'humidité. • Aucun objet contenant du liquide, par exemple un vase, ne doit être placé sur l'appareil. <p>PRECAUZIONI:</p> <ul style="list-style-type: none"> • Le aperture di ventilazione non devono essere ostruite coprendole con oggetti, quali giornali, tovaglie, tende e così via. • Non posizionare sull'apparecchiatura fiamme libere, come ad esempio le candele accese. • Prestare attenzione agli aspetti legati alla tutela dell'ambiente quando si smaltisce la batteria. • L'apparecchiatura non deve essere esposta a gocciolii, o spruzzi. • Non posizionare sull'apparecchiatura nessun oggetto contenente liquidi, come ad esempio i vasi. <p>PRECAUCIÓN:</p> <ul style="list-style-type: none"> • La ventilación no debe quedar obstruida por hacerse cubierto las aperturas con objetos como periódicos, manteles, cortinas, etc. • No debe colocarse sobre el aparato ninguna fuente inflamable sin protección, como velas encendidas. • A la hora de deshacerse de las pilas, respeta la normativa para el cuidado del medio ambiente. • No se exporará el aparato al goteo o salpicaduras cuando se utilice. • No se colocarán sobre el aparato objetos llenos de líquido, como jarras. <p>WAARSCHUWING:</p> <ul style="list-style-type: none"> • De ventilatie mag niet worden belemmerd door de ventilatieopeningen af te dekken met bijvoorbeeld kranten, een tafelkleed, gordijnen, enz. • Plaats geen open vlammen, bijvoorbeeld een brandende kaars, op het apparaat. • Houd u steeds aan de milieuvoorwaarden wanneer u gebruikte batterijen weggooit. • Stel het apparaat niet bloot aan druppels of spatten. • Plaats geen voorwerpen gevuld met water, bijvoorbeeld een vaas, op het apparaat. <p>OBSERVERERA:</p> <ul style="list-style-type: none"> • Ventilatorerna bör inte förhindras genom att täcka för ventilationsöppningarna med föremål såsom tidningar, bordsdukar, gardiner osv. • Inga blottade brandkällor, såsom tända ljus, bör placeras på apparaten. • Tänk på miljöspektrerna när du bortskäftar batteri. • Apparaten får inte utsättas för vätska. • Inga objekt med vätskor, såsom vaser, får placeras på apparaten.
 <ul style="list-style-type: none"> • Handle the power cord carefully. • Hold the plug when unplugging the cord • Gehen Sie vorsichtig mit dem Netzkabel um. • Halten Sie das Kabel am Stecker, wenn Sie den Stecker herausziehen. • Manipuler le cordon d'alimentation avec précaution. • Tenez la prise lors du débranchement du cordon. • Maneggiare il filo di alimentazione con cura. • Agite per la spina quando scollegate il cavo dalla presa. • Manténe el cordón de energía con cuidado. • Sostenga el enchufe cuando desconecte el cordón de energía. • Hanter het netsnoer voorzichtig. • Houid het snoer bij de stekker vast wanneer deze moet worden aan- of afgekoppeld. • Hantera nätkabeln varsamt. • Håll i kabein när den kopplas från el-tuttaget. 	 <ul style="list-style-type: none"> • Unplug the power cord when not using the apparatus for long periods of time. • Wenn das Gerät eine längere Zeit nicht verwendet werden soll, trennen Sie das Netzkabel vom Netzstecker. • Débrancher le cordon d'alimentation lorsque l'appareil n'est pas utilisé pendant de longues périodes. • Disinnestare il filo di alimentazione quando avete l'intenzione di non usare il filo di alimentazione per un lungo periodo di tempo. • Desconecte el cordón de energía cuando no utilice el equipo por mucho tiempo. • Neem altijd het netsnoer uit het stopcontact wanneer het apparaat gedurende een lange periode niet wordt gebruikt. • Koppla ur nätkabeln om apparaten inte kommer att användas i lång tid. 	 <ul style="list-style-type: none"> • Do not let insecticides, benzene, and thinner come in contact with the apparatus. • Lassen Sie das Gerät nicht mit Insektiziden, Benzin oder Verdünnungsmitteln in Berührung kommen. • Ne pas mettre en contact des insecticides, du benzène et un diluant avec l'appareil. • Assicurarsi che l'unità non venga in contatto con insetticidi, benzolo o solventi. • No permita el contacto de insecticidas, gasolina y diluyentes con el equipo. • Laat geen insektenverdelgende middelen, benzine of verfverduuner met dit apparaat in contact komen. • Se till att inte insektsmedel på spraybruk, bensin och thinner kommer i kontakt med apparatens hölje. 	<p>PRECAUCIÓN:</p> <ul style="list-style-type: none"> • La ventilación no debe quedar obstruida por hacerse cubierto las aperturas con objetos como periódicos, manteles, cortinas, etc. • No debe colocarse sobre el aparato ninguna fuente inflamable sin protección, como velas encendidas. • A la hora de deshacerse de las pilas, respeta la normativa para el cuidado del medio ambiente. • No se exporará el aparato al goteo o salpicaduras cuando se utilice. • No se colocarán sobre el aparato objetos llenos de líquido, como jarras. <p>WAARSCHUWING:</p> <ul style="list-style-type: none"> • De ventilatie mag niet worden belemmerd door de ventilatieopeningen af te dekken met bijvoorbeeld kranten, een tafelkleed, gordijnen, enz. • Plaats geen open vlammen, bijvoorbeeld een brandende kaars, op het apparaat. • Houd u steeds aan de milieuvoorwaarden wanneer u gebruikte batterijen weggooit. • Stel het apparaat niet bloot aan druppels of spatten. • Plaats geen voorwerpen gevuld met water, bijvoorbeeld een vaas, op het apparaat. <p>OBSERVERERA:</p> <ul style="list-style-type: none"> • Ventilatorerna bör inte förhindras genom att täcka för ventilationsöppningarna med föremål såsom tidningar, bordsdukar, gardiner osv. • Inga blottade brandkällor, såsom tända ljus, bör placeras på apparaten. • Tänk på miljöspektrerna när du bortskäftar batteri. • Apparaten får inte utsättas för vätska. • Inga objekt med vätskor, såsom vaser, får placeras på apparaten.

A NOTE ABOUT RECYCLING:

This product's packaging materials are recyclable and can be reused. Please dispose of any materials in accordance with the local recycling regulations.
 When discarding the unit, comply with local rules or regulations.
 Batteries should never be thrown away or incinerated but disposed of in accordance with the local regulations concerning chemical waste.
 This product and the accessories packed together constitute the applicable product according to the WEEE directive except batteries.

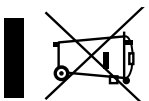

HINWEIS ZUM RECYCLING:

Das Verpackungsmaterial dieses Produktes ist für zum Recyceln geeignet und kann wieder verwendet werden. Bitte entsorgen Sie alle Materialien entsprechend der örtlichen Recycling-Vorschriften.
 Beachten Sie bei der Entsorgung des Gerätes die örtlichen Vorschriften und Bestimmungen.
 Die Batterien dürfen nicht in den Hausmüll geworfen oder verbrannt werden, bitte geben Sie die Batterien gemäß örtlichen Bestimmungen an den Sammelstellen oder Sondermüllplätzen ab.
 Dieses Produkt zusammen mit den Zubehörteilen ist das geltende Produkt der WEEE-Direktive, davon ausgenommen sind die Batterien.

UNE REMARQUE CONCERNANT LE RECYCLAGE:

Les matériaux d'emballage de ce produit sont recyclables et peuvent être réutilisés. Veuillez disposer de tout matériel conformément aux règlements de recyclage locaux.
 Lorsque vous mettez cet appareil au rebut, respectez les lois ou réglementations locales.
 Les piles ne doivent jamais être jetées ou incinérées, mais mises au rebut conformément aux règlements locaux concernant les déchets chimiques.
 Ce produit et les accessoires emballés ensemble sont des produits conformes à la directive DEEE sauf pour les piles.

NOTA RELATIVA AL RICICLAGGIO:

I materiali di imballaggio di questo prodotto sono riutilizzabili e riciclabili. Smaltire i materiali conformemente alle normative locali sul riciclaggio.
 Per smaltire l'unità, osservare la normativa in vigore nel luogo di utilizzo.
 Non gettare le batterie, né incenerirle, ma smaltirle conformemente alla normativa locale sui rifiuti chimici.
 Questo prodotto e gli accessori inclusi nell'imballaggio sono applicabili alla direttiva RAEE, ad eccezione delle batterie.

ACERCA DEL RECICLAJE:

Los materiales de embalaje de este producto son reciclables y se pueden volver a utilizar. Disponga de estos materiales siguiendo los reglamentos de reciclaje de su localidad.
 Cuando se deshaga de la unidad, cumpla con las reglas o reglamentos locales.
 Las pilas nunca deberán tirarse ni incinerarse. Deberá disponer de ellas siguiendo los reglamentos de su localidad relacionados con los despendidos químicos.
 Este producto junto con los accesorios empacutados es el producto aplicable a la directiva RAEE excepto pilas.

EEN AANTEKENING WAT BETREFT HET RECYCLEREN:

Het inpakmateriaal van dit product is recycleerbaar en kan opnieuw gebruikt worden. Er wordt verzocht om zich van elk afvalmateriaal te ontdoen volgens de plaatselijke voorschriften.
 Volg voor het wegdoen van de speler de voorschriften voor de verwijdering van wit- en bruingoed op.
 Batterijen mogen nooit worden weggegooid of verbrand, maar moeten volgens de plaatselijke voorschriften betreffende chemisch afval worden verwijderd.
 Op dit product en de meegeleverde accessoires, m.u.v. de batterijen is de richtlijn voor atgedankte elektrische en elektronische apparaten (WEEE) van toepassing.

EN KOMMENTAR OM ÅTERVINNING:

Produktens emballage är återvinningsbart och kan återanvändas. Kassera det enligt lokala återvinningsbestämmelser.
 När du kasserar enheten ska du göra det i överensstämmelse med lokala regler och bestämmelser.
 Batterier får absolut inte kastas i soporna eller brännas. Kassera dem enligt lokala bestämmelser för kemiskt avfall.
 Denna apparat och de tillbehör som levereras med den är de som upplyter gällande WEEE-direktiv, med undantag av batterierna.

CAUTION:

To completely disconnect this product from the mains, disconnect the plug from the wall socket outlet.
 The mains plug is used to completely interrupt the power supply to the unit and must be within easy access by the user.

VORSICHT:

Um dieses Gerät vollständig von der Stromversorgung abzutrennen, trennen Sie bitte den Netzstecker von der Wandsteckdose ab.
 Die Hauptstecker werden verwendet, um die Stromversorgung zum Gerät völlig zu unterbrechen; er muss für den Benutzer gut und einfach zu erreichen sein.

PRECAUTION:

Pour déconnecter complètement ce produit du courant secteur, débranchez la prise de la prise murale.
 La prise secteur est utilisée pour couper complètement l'alimentation de l'appareil et l'utilisateur doit pouvoir y accéder facilement.

ATTENZIONE:

Per scollegare definitivamente questo prodotto dalla rete di alimentazione elettrica, togliere la spina dalla relativa presa.
 La spina di rete viene utilizzata per interrompere completamente l'alimentazione all'unità e deve essere facilmente accessibile all'utente.

PRECAUCIÓN:

Para desconectar completamente este producto de la alimentación eléctrica, desconecte el enchufe del enchufe de la pared.
 El enchufe de la alimentación se utiliza para interrumpir por completo el suministro de alimentación a la unidad y debe de encontrarse en un lugar al que el usuario tenga fácil acceso.

VOORZICHTIGHEID:

Om de voeding van dit product volledig te onderbreken moet de stekker uit het stopcontact worden getrokken.
 De netstekker wordt gebruikt om de stroomtoevoer naar het toestel volledig te onderbreken en moet voor de gebruiker gemakkelijk bereikbaar zijn.

FÖRSIKTIGHETSMÅTT:

Koppla loss stickproppen från eluttaget för att helt skilja produkten från nätet.
 Stickproppen används för att helt bryta strömförsörjningen till apparaten, och den måste vara lättillgänglig för användaren.

Getting Started

Thank you for purchasing this DENON CD Player. Please read the operation instructions thoroughly in order to acquaint yourself with the CD player and achieve maximum satisfaction from it.
Be sure to keep these instructions for future reference, should any questions or problems arise.

Contents

Getting Started		Operation	
Accessories	2	Turning the power on	7
Before using	2	Loading discs	7
About discs		Starting playback	7
Discs usable on this set.....	2	To stop playback.....	7
Holding discs.....	2	To pause playback.....	7
Loading discs.....	2	Fast-forwarding and fast-reversing through tracks (Search)	7
Cautions on loading discs.....	3	Moving to the beginning of tracks (Skip)	8
Cautions on handling.....	3	Playing the desired track (Direct play)	8
Cautions on storing discs.....	3	Listening to specific tracks in a specific order (Programmed play)	8
Cleaning discs.....	3	Listening in random order (Random playback)	8
About the remote control unit		Listening to tracks repeatedly (Repeat play)	
Inserting the batteries.....	3	Listening to all the tracks repeatedly (All-track repeat play).....	9
Operating range of the remote control unit.....	3	Listening to a specific track repeatedly (1-track repeat play).....	9
Part names and functions		Listening to a specific section between two points repeatedly (A-B repeat play).....	9
Front panel.....	4	Quing and stopping playback (Pause)	
Display.....	4	Quing with programmed searching.....	9
Rear panel.....	5	Using the timer play function.....	9
Remote control unit.....	5		
Connections		Others	
Cable indications	6	Troubleshooting	10
Analog connections	6	Specifications	10
Digital connections	6		
Connecting the power supply cord	6		

Getting Started

Accessories

Check that the following parts are attached in addition to the main unit:

- ① Operating instructions 1
- ② Service station list..... 1
- ③ Remote control unit (RC-1028) 1
- ④ R03/AAA batteries 2
- ⑤ Pin-plug cable (Cable length: Approx. 1.0 m)..... 1

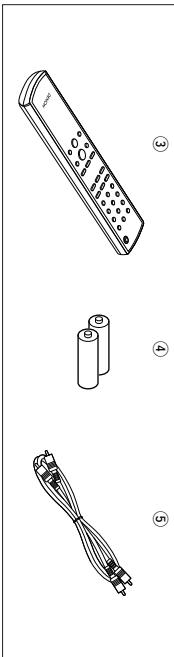

Before using

- **Handle the power supply cord carefully.**
Do not damage or deform the power supply cord. If it is damaged or deformed, it may cause electric shock or malfunction when used. When disconnecting the power supply cord from the wall outlet, hold the plug and do not pull on the cable.
- **Do not open the top cover.**
In order to prevent electric shock, do not open the top cover. If problems occur, contact your DENON dealer.
- **Do not place anything inside.**
Prevent metal objects from entering the CD player and avoid spilling liquids on it.
Electric shock or malfunction may result.
- **Cautions on moving.**
First, if a disc is loaded, eject it, then turn off the power, unplugging the power supply cord from the power outlet and disconnect the connection cables with other devices.
- **Cautions on using mobile phones.**
Using a mobile phone near this unit may result in noise. If so, move the mobile phone away from this unit when it is in use.
- **Sufficiently ventilate the place of installation.**
If the unit is left in a room full of the smoke from cigarettes, etc., for long periods of time, the surface of the optical pickup could get dirty, in which case it will not be able to read the signals properly.

- **Store the operating instructions in a safe place.**
After reading the operating instructions, store them in a safe place as they could come in handy in the future.

• **Note that the illustrations in these instructions may differ from the actual unit for explanation purposes.**

NOTE:

- This CD player uses a semiconductor laser. To ensure stable operation, it is recommended to use the set indoors at a temperature of 5°C (41°F) ~ 35°C (95°F).

About discs

Discs usable on this set

1 Music CDs

Discs with the mark at the right can be used on this set.
Note however that discs with special shapes (heart-shaped discs, octagonal discs, etc.) cannot be played. Do not attempt to play them, as doing so could damage the set.

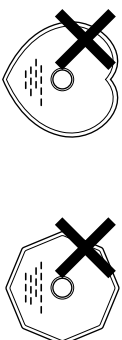

2 CD-R/CD-RW

- Some discs and some recording formats may not be playable.
- Non-finalized discs cannot be played.

* Finalization:

Finalization is the process that makes recorded CD-R/CD-RW discs playable on compatible players.

Holding discs

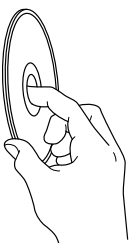

Do not touch the signal surface.

Getting Started

Loading discs

- Set the disc with the labeled side facing up.
- Make sure the disc tray is fully open when inserting the disc.
- Place the discs flatly, 12 cm discs in the outer tray guide (Figure 1), 8 cm discs in the inner tray guide (Figure 2).

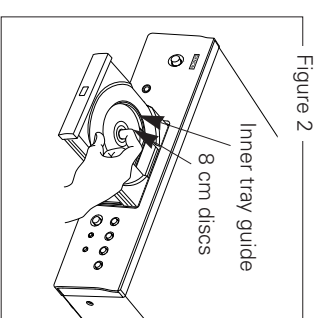
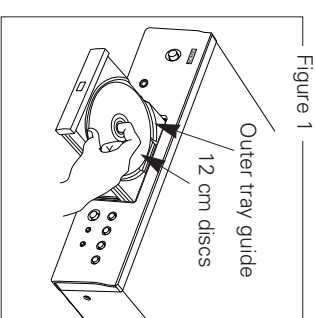

- Place 8 cm discs in the inner tray guide without using an adapter.

- "NO DISC" is displayed if a disc is loaded upside down or if no disc is loaded.

Getting Started

Cautions on loading discs

- Only load one disc at a time. Loading two or more discs can damage the set or scratch the discs.
- Do not use cracked or warped discs or discs that have been repaired with adhesive, etc.
- Do not use discs on which the sticky part of cellophane tape or labels is exposed or on which there are traces of where labels have been removed. Such discs could get caught inside the player and damage it.

Cautions on handling

- Do not get fingerprints, oil or dirt on discs.
- Take special care not to scratch discs when removing them from their cases.
- Do not bend or heat discs.
- Do not enlarge the hole at the center.
- Do not write on the labeled (printed) surface with ball-point pens, pencils, etc., or stick new labels on discs.
- Water droplets may form on discs if they are moved suddenly from a cold place (outdoors for example) to a warm place, but do not try to dry them off using a hairdryer, etc.

Cautions on storing discs

- Be sure to remove discs after using them.
- Be sure to store discs in their cases to protect them from dust, scratches, warping, etc.
- Do not store discs in the following places:
 1. Places exposed to direct sunlight for long periods of time
 2. Dusty or humid places
 3. Places exposed to heat from heating appliances, etc.

Cleaning discs

- If there are fingerprints or dirt on discs, wipe them off before using the disc. If not the sound quality could be reduced and the sound may be broken.
- Use a commercially available disc cleaning set or a soft cloth to clean discs.

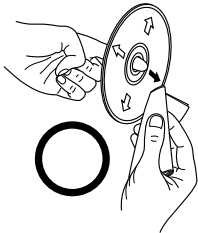

Gently wipe the disc from the inside towards the outside.

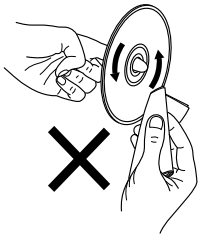

Do not wipe with a circular motion.

- NOTE:**
- Do not use record spray, antistatic agents, or benzene, thinner or other solvents.

About the remote control unit

Inserting the batteries

- ① Remove the remote control unit's rear cover.
- ② Set two R03/AAA batteries in the battery compartment in the indicated direction.

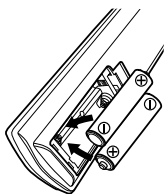
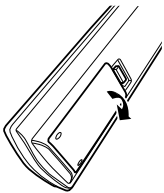

- ③ Put the rear cover back on.

Getting Started

Notes on batteries:

- Replace the batteries with new ones if the set does not operate even when the remote control unit is operated nearby the unit. (The attached batteries are only for verifying operation.)
- When inserting the batteries, be sure to do so in the proper direction, following the “ \oplus ” and “ \ominus ” marks in the battery compartment.
- To prevent damage or leakage of battery fluid:
 - Do not use a new battery together with an old one.
 - Do not use two different types of batteries.
- Do not short-circuit, disassemble, heat or dispose of batteries in flames.
- If the battery fluid should leak, carefully wipe the fluid off the inside of the battery compartment and insert new batteries.
- Remove the batteries from the remote if it will not be in use for long periods.

Operating range of the remote control unit

- Point the remote control unit at the remote sensor when operating it.
- The remote control unit can be used from a distance of up to about 8 meters, at a horizontal angle of up to 30° with respect to the sensor.

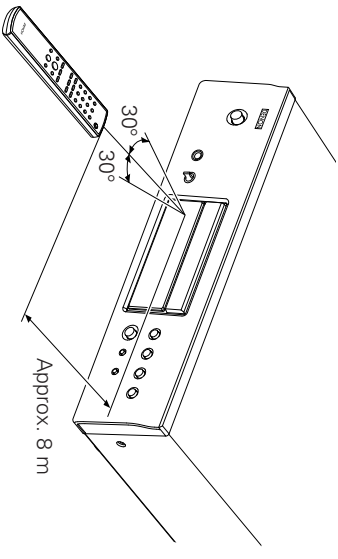

NOTE:

- It may be difficult to operate the remote control unit if the remote sensor is exposed to direct sunlight or strong artificial light.

Getting Started

Part names and functions

For buttons not explained here, see the page indicated in parentheses ().

Front panel

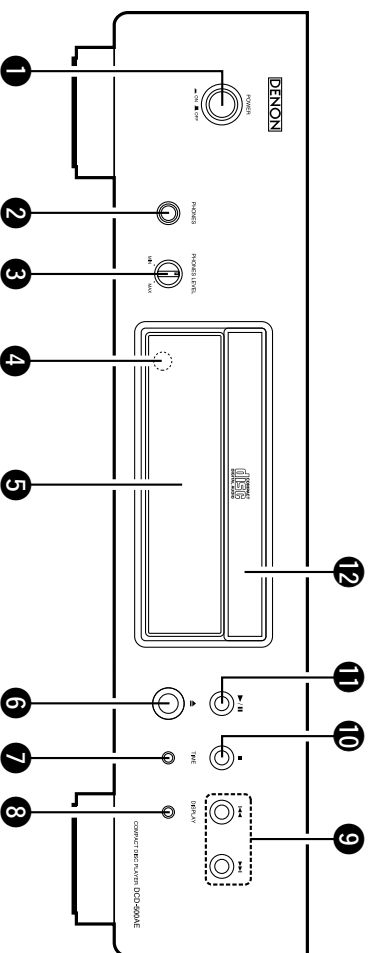

- 1 **POWER switch** (7)
- 2 **PHONES jack**
Insert the headphones' plug. (7)
- 3 **PHONES LEVEL knob**
Adjusts the volume of the headphones. (2)
- 4 **Remote control sensor** (3)
- 5 **Display** (4)
- 6 **Disc tray open/close button** (▲) (7)
- 7 **TIME button** (7)
- 8 **DISPLAY button**
 Switching the display brightness
The brightness switches as shown below each time the button is pressed (**and released within 1 second**).

←	→
Normal brightness	Approx. 2/3 the normal brightness
←	→
Entire display off *	Approx. 1/3 the normal brightness

* Some of the display remains lit if no disc is playing or loaded.
- 9 **Skip buttons** (◀▶▶▶, ▶▶▶▶) (8)
- 10 **Stop button** (■) (7)
- 11 **Play/Pause button** (▶/||) (7)
- 12 **Disc tray** (2)

Getting Started

Display

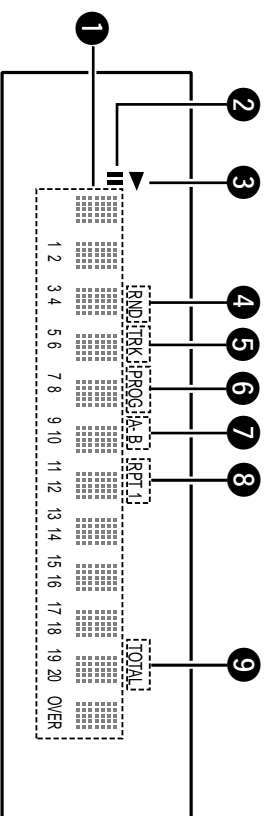

- 1 **Information display**
Various information is displayed here, depending on the operation mode.
For a music CD:
 - Total number of tracks
 - Total playing time
 - Track number
 - Elapsed time, etc.
 - 20-track music calendar
 - Program number
- 2 Lights when the pause mode is set.
- 3 Lights when a disc is playing.
- 4 Lights when in the random play mode.
- 5 Lights when the track number is displayed.
- 6 Lights when in the program play mode.
- 7 Lights when in the A-B repeat play mode.
- 8 Lights when in the repeat play mode.
The display switches as follows each time the REPEAT button on the remote control unit is pressed.
 - In modes other than the folder mode:

RPT	RPT 1
(All-track repeat)	(One-track repeat)
←	→
Not displayed	Not displayed
- 9 Lights when the total number of tracks and total time are displayed at 1.

Rear panel

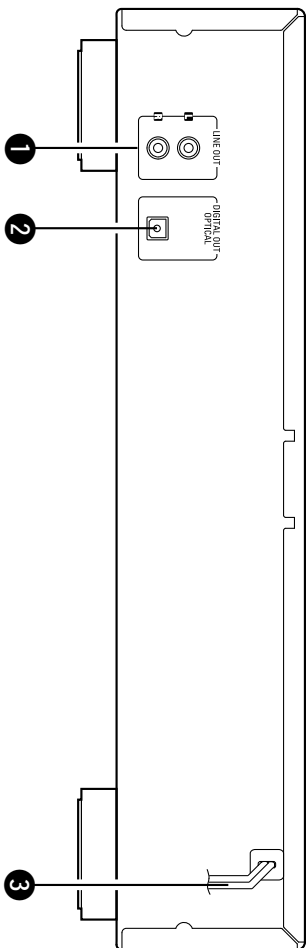

- 1 LINE OUT terminals (6)
- 2 DIGITAL OUT OPTICAL terminal (6)
- 3 Power supply cord (6)

Remote control unit

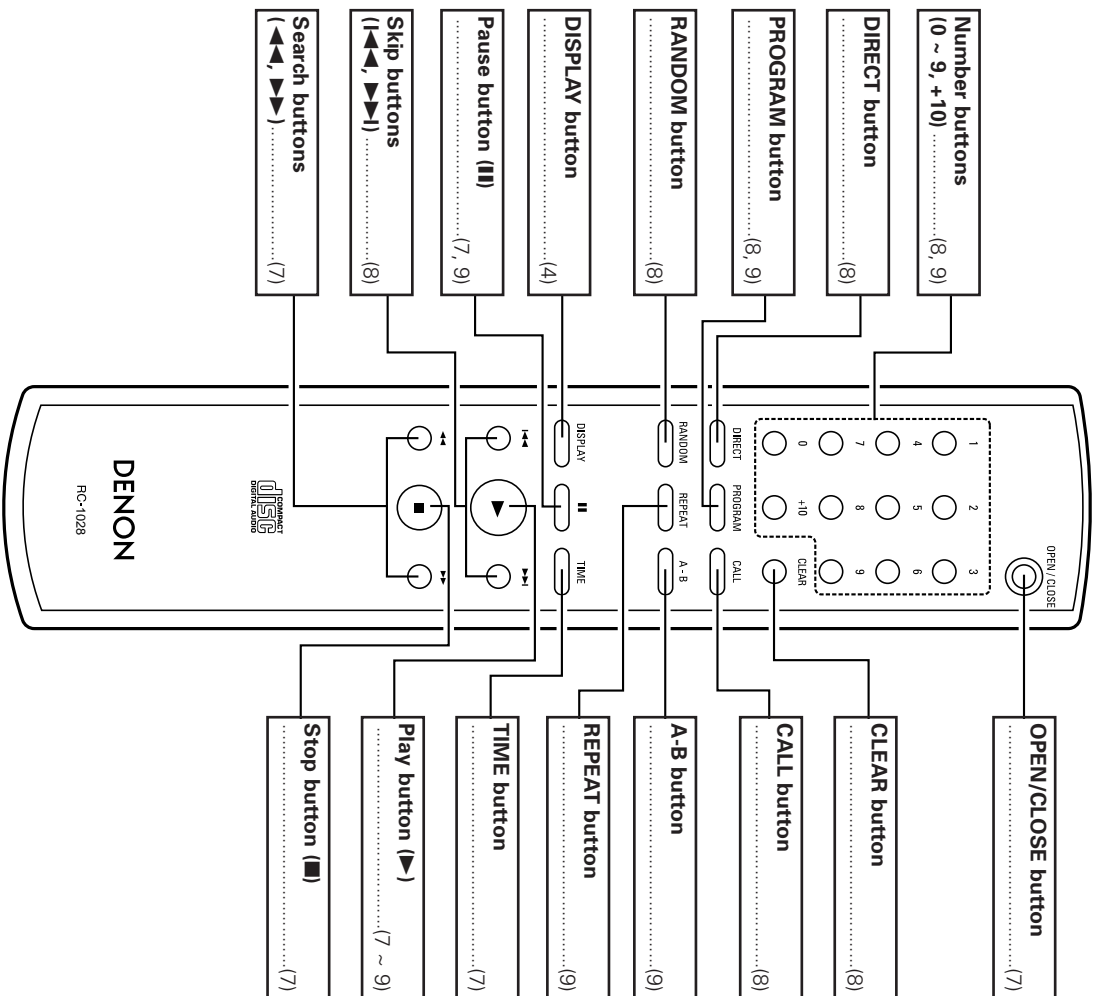

 The skip buttons (I◀ and ▶I) and +10 button operate continuously when held in.











Connections

NOTE:

- Do not plug in the power supply cord until all connections have been completed.
- When making connections, also refer to the operating instructions of the other components.
- Be sure to connect the left and right channels properly (left with left, right with right).
- Making connections with the power turned on could result in noise or damage to the speakers.
- Bunching the power supply cords and connection cables together could result in humming or noise.

Cable indications

Connect using the connection cables shown below.

Audio cable	Signal direction
<p>A Analog connections (Stereo)</p> <p>(White)  </p> <p>(Red)  </p> <p>Pin-plug cable  </p> <p>B Digital connections (Optical)</p> <p> </p> <p>Optical fiber cable </p>	<p>Audio signal</p> <p>OUT </p> <p>IN </p>

Analog connections

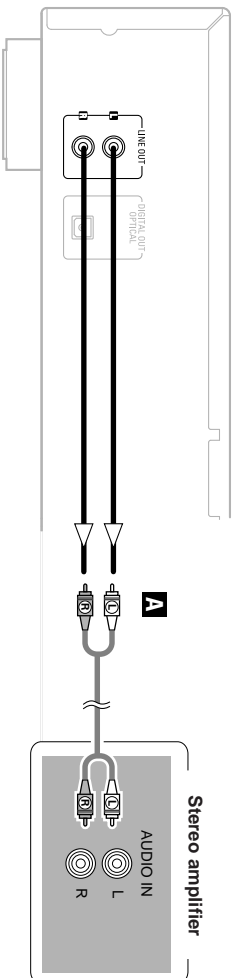

Digital connections

There is a protective cap over the optical digital output terminal. Remove the protective cap and insert the plug firmly until it locks.

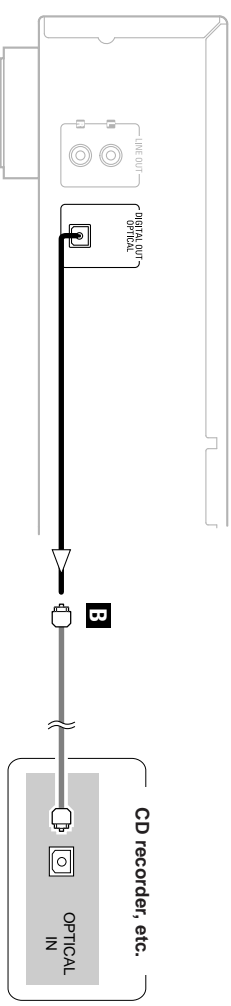

When connecting the optical digital output connector with an optical transmission cable (commercially available)

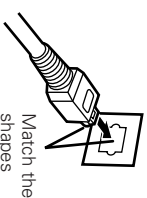

Match the shapes then insert firmly all the way in.

- Store the protective cap in a safe place so as not to lose it, and use it when not using the terminal.

Connecting the power supply cord

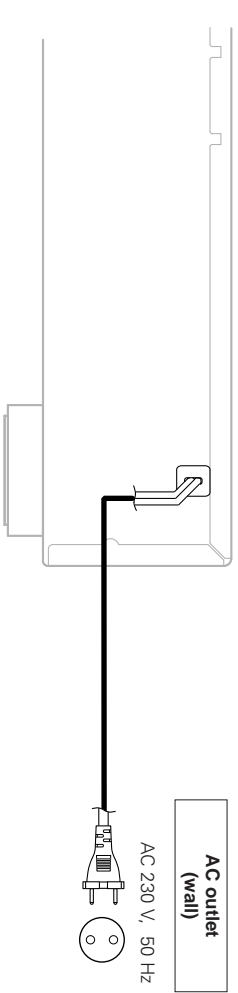

NOTE:

- Insert the plugs securely. Incomplete connections will result in the generation of noise.
- Do not unplug the power supply cord while the set is operating.

Operation

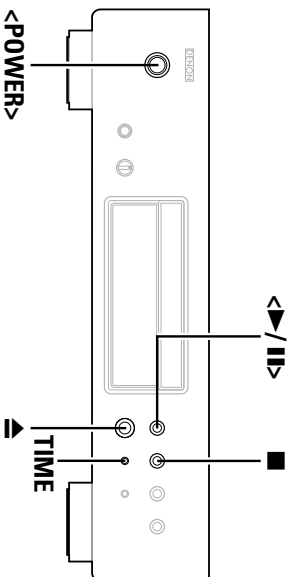

Turning the power on

- Press <POWER>.**
- When a disc is loaded, playback starts automatically.
 - If no disc is loaded "NO DISC" is displayed.

- To turn off the power:**
Press <POWER> again.

- NOTE:**
- To turn off the power while a disc is playing, be sure to press ■ to stop playback before turning off the power.

Loading discs

(📖 page 2)

- Press ▲ to open the disc tray.

- To close the disc tray:**
Press ▲ again.

- NOTE:**
- Be sure to turn on the power when opening and closing the disc tray.
 - Do not push the disc tray in by hand when the power is off. Doing so could damage it.
 - Do not insert foreign objects into the disc tray. Doing so will damage it.

Starting playback

- Press <>/|||> or [▶].**
- The "▶" indicator lights and playback starts.

- Once all the tracks remove recorded on the disc have been played, the stop mode is set automatically.
- **TIME** can be used to switch the information displayed.

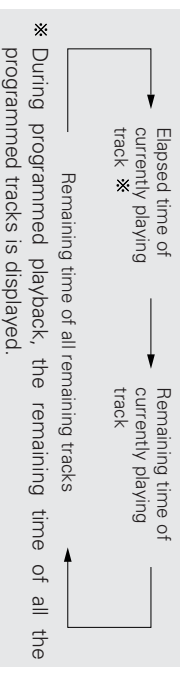

To stop playback

- Press ■ during playback.

To pause playback

- Press <>/|||> or [|||] during playback.**
- The "|||" indicator lights and the pause mode is set.

- To resume playback:**
Press <>/|||> or [▶].

Fast-forwarding and fast-reversing through tracks (Search)

- Press and hold [▶▶] or [◀◀] during playback.**

- ※ Normal playback resumes when you release your 'finger' from the button.



- The sound may be interrupted shortly when resuming normal playback after searching.

About the button names in this explanation

- < > : Buttons on the main unit
- [] : Buttons on the remote control unit

Button name only :
Buttons on the main unit and remote control unit

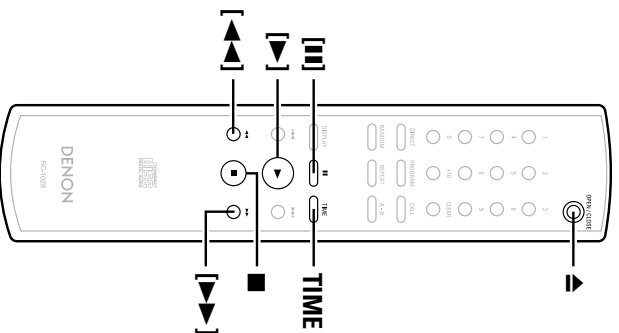

Listening to tracks repeatedly (Repeat play)

Listening to all the tracks repeatedly (All-track repeat play)

- 1 Press [REPEAT] once.**
 - The "RPT" indicator lights.
- 2 Press <▶/||> or [▶].**
 - During normal playback: All the tracks are played repeatedly.
 - During programmed playback: The tracks are played repeatedly in the programmed order.
 - In the random play mode: The tracks are played once each in random order, then played again in a different order.

- Stopping all-track repeat playback:** Press [REPEAT] twice in a row, or press ▲ to open the disc tray.

-  In the programmed play or random play mode during all-track repeat playback, normal playback resumes when [REPEAT] is pressed once.

Listening to a specific track repeatedly (1-track repeat play)

- During playback, press [REPEAT] twice in a row.
- The "RPT1" indicator lights and that track is played repeatedly.

- Stopping 1-track repeat playback:** Press [REPEAT] again, or press ▲ to open the disc tray.

-  1-track repeat playback is not possible during programmed or random playback.

Listening to a specific section between two points repeatedly (A-B repeat play)

- 1 During playback, press [A-B] at the point at which you want to start repeating (point A).**
 - The "A-" indicator lights.
- 2 During playback, press [A-B] at the point at which you want to stop repeating (point B).**
 - The "A-B" indicator lights and the A-B section is played repeatedly.

- Stopping A-B repeat playback:** Press [A-B] again.

-  A-B repeat playback is not possible during programmed playback or random playback.

Pausing and stopping playback (Pause)

Pausing with direct searching

- 1** Either press <▶/||> twice or press [III] once.
- 2** Use [NUMBER] (0 ~ 9, +10) to select the track.

- To start playback:** Press <▶/||> or [▶].

Pausing with programmed searching

- 1** Press [PROGRAM].
- 2** Use [NUMBER] (0 ~ 9, +10) to select the track.
- 3** Either press <▶/||> twice or press [III] once.

- To start playback:** Press <▶/||> or [▶].

Using the timer play function

Also refer to the operating instructions of the timer device.

CCD-500AE (This unit)

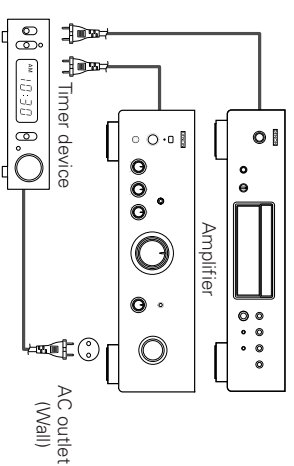

- 1** Turn on the power of the connected components.
 - 2** Switch the amplifier's input function to the function to which the player is connected.
 - 3** Load a disc in the player.
 - 4** Set the audio timer for the desired times.
 - 5** Turn the timer "ON".
 - The power of the components connected to the timer turns off.
- * When the set time is reached, the power of the different components automatically turns on and playback starts from the first track.

Others

Troubleshooting

If a problem should arise, first check the following:

1. Are the connections correct ?
2. Have you operated the player according to the Operating Instructions ?

If this unit is not operating properly, check the items listed in the table below. Should the problem persist, there may be a malfunction. Disconnect the power immediately and contact your store of purchase.

Symptom	Measures	Cause	Page
Disc tray does not open.	<ul style="list-style-type: none"> • The power is not on. • The disc is not properly loaded. 	<ul style="list-style-type: none"> • Turn on the power. • Reload the disc. 	7
"NO DISC" is displayed even though a disc is loaded.	<ul style="list-style-type: none"> • The loaded disc is not a CD. 	<ul style="list-style-type: none"> • Load a CD. 	2
"00 00 : 00" is displayed even though a disc is loaded.	<ul style="list-style-type: none"> • The disc is dirty or scratched. 	<ul style="list-style-type: none"> • Wipe the dirt off the disc or replace the disc. 	3
Disc is not played when play button is pressed.	<ul style="list-style-type: none"> • The output cables are not properly connected to the amplifier. • The amplifier's function setting or adjustments are not right. 	<ul style="list-style-type: none"> • Check the connections. • Check the amplifier's function and controls and adjust as necessary. 	6
No sound is produced or sound is distorted.	<ul style="list-style-type: none"> • The connection cables are not properly connected. 	<ul style="list-style-type: none"> • Check the connections. 	6
No digital signals are output.	<ul style="list-style-type: none"> • The disc is dirty or scratched. 	<ul style="list-style-type: none"> • Wipe the dirt off the disc or replace the disc. 	3
Specific section of the disc cannot be played properly.	<ul style="list-style-type: none"> • The tracks have not been programmed properly. 	<ul style="list-style-type: none"> • Program properly. 	8
Programmed playback is not possible.	<ul style="list-style-type: none"> • The disc has not been finalized. • The recording conditions are bad or the quality of the disc itself is poor. 	<ul style="list-style-type: none"> • Finalize the disc then play it. • Use a properly recorded disc. 	2
A CD-R or CD-RW disc cannot be played.	<ul style="list-style-type: none"> • The batteries are spent. • The remote control unit is too far from the set. 	<ul style="list-style-type: none"> • Replace the batteries with new ones. • Move the remote control unit closer to the set. 	3
Set does not operate properly when remote control unit is operated.			3

Specifications

Audio performance

- Analog output
 - Channels: 2 channels
 - Playable frequency range: 2 Hz ~ 20 kHz
 - S/N: 105 dB
 - Dynamic range: 98 dB
 - Harmonic distortion: 0.003 % (1 kHz)
 - Wow & flutter: Below measurable limits
- Output level: 2.0 V (10 k Ω /kohms)
- Signal type: 16-bit linear PCM
- Sampling frequency: 44.1 kHz
- Usable discs: Compact Disc
- Digital output
- Optical:
 - Emission wavelength: -15 ~ -21 dBm
 - 660 nm

General

- Power supply: AC 230 V, 50 Hz
- Power consumption: 13 W
- Maximum external dimensions: 434 (W) x 107 (H) x 279 (D) mm (including protruding parts)
- Mass: 4.0 kg

Remote control unit (RC-1028)

- Remote control type: Infrared pulse
- Batteries: R03/AAA Type (two batteries)
- External dimensions: 49 (W) x 220 (H) x 21 (D) mm
- Mass: 106 g (included batteries)

* For purposes of improvement, specifications and design are subject to change without notice.

DENON
TOKYO, JAPAN
www.denon.com

Denon Brand Company, D&M Holdings Inc.
Printed in China 00D 511 4552 009