

DENON

Hi-Fi Component

FOR EUROPE AND U.K. MODELS

SERVICE MANUAL

STEREO CD PLAYER

MODEL DCD-820



TABLE OF CONTENTS

OPERATING INSTRUCTIONS	2 ~ 12
SPECIFICATIONS	13
NOTE FOR HANDLING OF LASER PICK-UP	14 ~ 16
DISASSEMBLY	17
ADJUSTMENT	18 ~ 24
HEAT RUN MODE FUNCTION	25
IC TERMINAL FUNCTION LIST	26 ~ 31
PARTS LIST OF P.W.BOARD	32, 33
PARTS LIST OF EXPLODED VIEW	34
PARTS LIST OF PACKING & ACCESSORIES	34
EXPLODED VIEW	35
EXPLODED VIEW OF MECHA UNIT	36
PARTS LIST OF MECHA UNIT	36
P.W.BOARD	37 ~ 38
WIRING DIAGRAM	39
SEMICONDUCTORS	40
SCHEMATIC DIAGRAM	41

NIPPON COLUMBIA CO., LTD.

IMPORTANT TO SAFETY

WARNING:

TO PREVENT FIRE OR SHOCK HAZARD, DO NOT EXPOSE THIS APPLIANCE TO RAIN OR MOISTURE.

CAUTION:

- Handle the power supply cord carefully**
Do not damage or deform the power supply cord. If it is damaged or deformed, it may cause electric shock or malfunction when used. When removing from wall outlet, be sure to remove by holding the plug attachment and not by pulling the cord.
- Do not open the top cover**
In order to prevent electric shock, do not open the top cover. If problems occur, contact your DENON dealer.
- Do not place anything inside**
Do not place metal objects or spill liquid inside the CD player. Electric shock or malfunction may result.

Please, record and retain the Model name and serial number of your set shown on the rating label.

Model No. DCD-820 Serial No. _____

IMPORTANT (BRITISH MODEL ONLY)

The wires in this mains lead are coloured in accordance with the following code:

Blue: Neutral
Brown: Live

The colours of the wires in the mains lead of this apparatus may not correspond with the coloured markings identifying the terminals in your plug proceed as follows.

The wire which is coloured blue must be connected to the terminal which is marked with the letter N or coloured black. The wire which is coloured brown must be connected to the terminal which is marked with the letter L or coloured red.

NOTE: This CD player uses the semiconductor laser. To allow you to enjoy music at a stable operation, it is recommended to use this in a room of 5°C – 35°C.

SAFETY INSTRUCTIONS FOR AUDIO SET

■ INSTALLATION

- Operate the set only from a power source which is indicated on the rating label (indication) at the back of the set.
- Frayed cords and broken plugs may cause a fire or shock hazard. Do not damage the power cord.
 - Do not cut and splice the power cord.
 - When removing the power cord from wall outlet, be sure to unplug by holding the plug attachment and not by pulling the cord. Do not hold the plug with wet hands.
 - Call your service technician for replacement of damaged cords and plugs.
- Select a place so that the location or position does not interfere with the proper ventilation of the set for releasing heat generated during operation.
 - Select a flat and level surface allowing enough space for setting up and operation.
 - Never block the bottom ventilation holes placing the set on a bed, sofa, rug, etc.
 - Never place the set in a "built-in" enclosure unless proper ventilation is provided.
 - Never place the set near or over a radiator, heat register or stove.
 - Avoid locations where the set is exposed directly to the sun light.

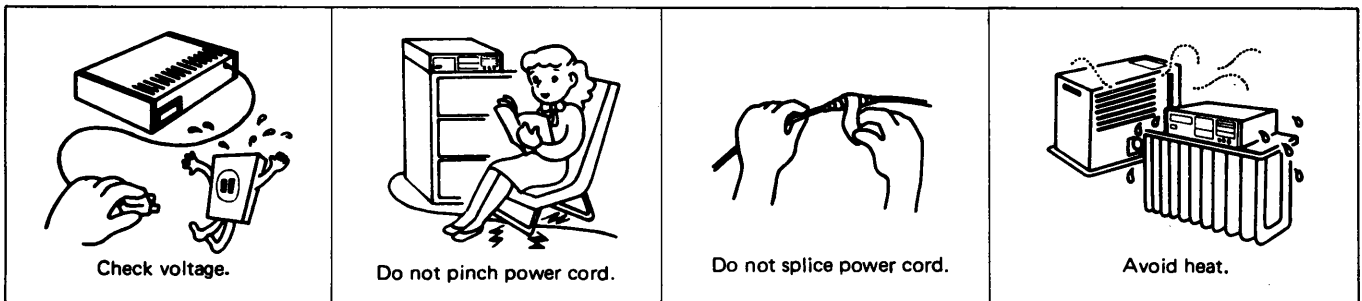

■ USE

- Do not expose the set to rain or water (liquid). Do not spill liquid or insert metal objects inside the set. Rain, water or liquid such as cosmetics as well as metal may cause electric shorts which can result in fire or shock hazard. If anything gets inside, unplug the power cord and have a DENON service technician check your set before further use.
- Never leave your set switched on when leaving the house. For added protection of your audio system during lightning storm or when the set is to be left unused for a long period of time, be sure to unplug the power cord from the wall outlet.
- Take care so that the set is not dropped to avoid damaging the cabinet which defeats safeguards or injuring yourself. If the set has been dropped or the cabinet has been damaged, unplug the set and have it checked by a DENON service technician to restore the safeguards.

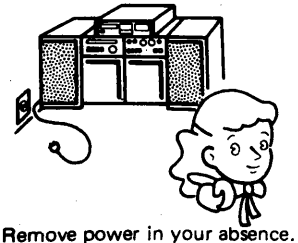

■ SERVICING

- The servicing of the set must not be attempted by yourself beyond that described in the operating instructions. In case of problems that cannot be settled by referring to your operating instructions, unplug the power cord and contact your DENON dealer. No user-serviceable parts are inside the set. Only qualified service technician can service inside your set.
- Refer to the operating instructions for maintenance and cleaning.

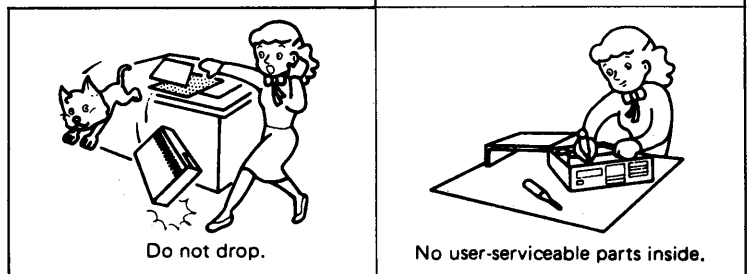

Thank you for purchasing this DENON Compact Disc Player. Please read the operating instructions thoroughly in order to acquaint yourself with the CD player and achieve maximum satisfaction from it.

Please check to make sure the following items are included with the main unit in the carton:

- (1) Operating Instructions 1
- (2) Connection Cord 1
- (3) Remote Control Unit RC-220 1

VAROITUS: SUOJAKOTELOA EI SAA AVATA. LAITE SISÄLTÄÄ LASERDIODIN, JOKA LÄHETTÄÄ NÄKYMÄTÖNTÄ SILMILLE VARRALLISTA LASERSÄTEILYÄ.

ADVARSEL: USYNLIG LASERSTRÅLING VED ABNING NAR SIKKERHEDSAFBRYDERE ER UDE AF FUNKTION. UNDGA UDSAETTELSE FOR STRÅLING.

WARNING: OSYNLIG LASERSTRÅLNING VID AVLÄGSNANDE AV APPARATENS HÖLJE. UNDVIK EXPONERING AV LASERSTRÅLNING.



"CLASS 1
LASER PRODUCT"

FEATURES

The DCD-820 Compact Disc Player incorporates DENON's Super Linear Converter which prevents deterioration of sound quality in PCM playback systems. This assures accurate reproduction of the digital signals recorded on compact discs no matter whether they are pure studio recordings or "live" performance recordings. All parts making up this CD player have selected with the greatest care in order to produce high quality realistic playback of the full musical content on compact discs.

(1) Double Super Linear Converter

The use of Denon's unique system and D/A converters with excellent resolution to prevent zero cross distortion, the main cause of reduced sound quality in the PCM playback system, make for sound field reproduction with rich musical expression.

(2) High Performance Digital Filter

The DCD-820 uses independent D/A converters for the left and right channels and an 8x oversampling high precision digital filter to bring out the best of the analog filter and offer clear, crisp sound.

(3) Digital Output

The data on the compact disc is output in digital format, so the music can be reproduced on an external digital processor or D/A unit.

(4) Simple Playback of 8cm CD Singles

8cm CD singles can be played without using an adaptor.

NAMES AND FUNCTIONS OF PARTS

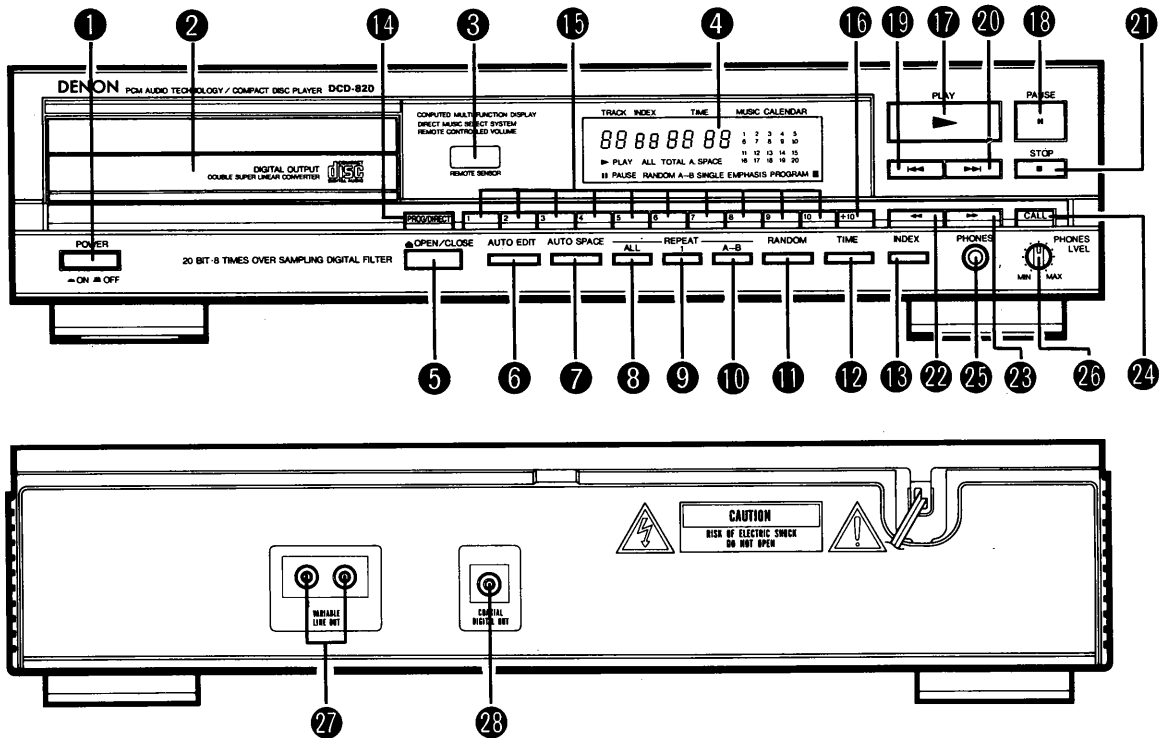

1 Power Switch (POWER)

- When the power is turned on, the volume level appears on the second portion on the TIME display, and if no disc is loaded, "00000000" appears on the digital display and the calendar lights after a few seconds.
- If the power is turned on with a disc already loaded, the total number of tracks on the disc is displayed on the TRACK NO. display, the total time is displayed on the TIME display, the numbers on the music calendar light up to the number of tracks on the disc, and playback begins.

2 Disc Holder

- Place the disc on the disc holder with the label facing up.
- Use the open/close button (▲ OPEN/CLOSE) 5 to open and close the disc holder.
- The disc holder may also be closed by pressing the play button (▶ PLAY) 16 or pause button (⏸ PAUSE) 18.

3 Remote Control Sensor

- This sensor receives the infrared light transmitted from the wireless remote control unit.
- For remote control, point the supplied remote control unit RC-220 towards this sensor.
- When a signal is transmitted from the remote control unit, the remote control indicator in the display 4 will light up briefly.

4 Display

- The digital display is divided into sections, such as displays for track number, index, playback time and calendar, as shown below.

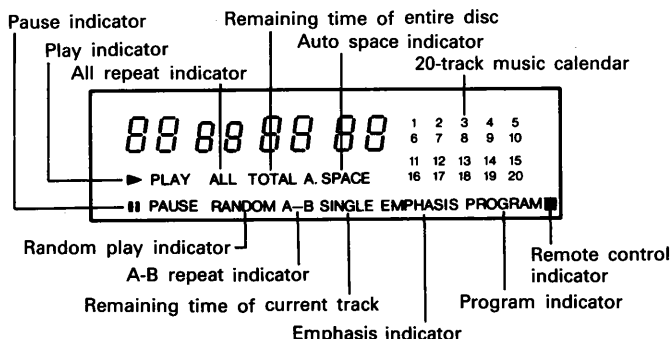

5 Open/Close Button (▲ OPEN/CLOSE)

- The disc holder is opened and closed by pressing this button.
- Press this button once to open the disc holder, and once again to close it.
- When the disc holder is closed with a disc loaded, the disc will rotate for a couple of seconds while the disc contents are read. The number of tracks and total playback time on the disc are then displayed on the digital display 4.

6 Auto Edit Button (AUTO EDIT)

- The tracks on a CD are automatically split into two halves, Side A and Side B, like an analog disc, with the division at the place between tracks which is closest to 1/2 the total playing time, and with the tracks remaining in the same order.
- When this button is pressed in the stop mode, the total playing time for the first half and the track numbers on the calendar are displayed for approximately 2 seconds. Next, the same is done for the second half, after which the unit is automatically set to the pause mode at the beginning of the first track of the second half which was previously displayed. When the PLAY or PAUSE button is pressed again, playback begins, and the unit is automatically set to the stop mode at the end of the last track on the disc.
- This function will only work for discs with a total of 20 tracks or less. Also, when this function is used the mode is automatically set to the program mode, so direct search is not possible.
- The auto edit function is cleared when the STOP or PROG/DIRECT button is pressed.
- The data for the total playing time recorded on the disc and the actual total playing time of the tracks differ, so there may be a difference between the time displayed in the stop mode (the total playing time) and the total of the times of the first and second halves in the auto edit mode (about 2 seconds).

7 Auto Space Button (AUTO SPACE)

- Pressing this button will cause the **[A.SPACE]** indicator to light and a blank space of approximately 4 seconds is inserted between tracks during CD playback. Pressing the button once more, the **[A.SPACE]** indicator goes out and the Auto Space feature is cancelled.
- When one of the track search buttons (**⏮** or **⏭**) is pressed, the Auto Space function will not operate.
- The Auto Space function will work during normal playback as well as programmed playback.
- Although 4-second blanks are inserted between tracks, this additional time is not reflected by the indication on the time remaining display or time display when the Auto Edit function is engaged.

8 Repeat All Tracks Button (ALL)

- Press this button to repeat playback of all tracks.
- When this button is pressed, **[ALL]** lights on the display and all tracks on the disc or in a program will be repeatedly played back. Press this button once more to disengage the Repeat All function.

9 1-track Repeat Button (1)

- Press this button to repeat one track only.
When pressed during playback, the track currently playing is repeated.

10 A-B Repeat Button (A – B)

- Press this button for repeat playback between a designated starting point (A) and an ending point (B). (Refer to page 8 for details.)

11 Random Play Button (RANDOM)

- Press this button to play the tracks on the disc in random order.

12 Time Mode Button (TIME)

- This button is used to select the desired indication on the TIME display. The indication on this display will change each time the button is pressed.
Normally, the elapsed playback time of the current track is displayed.
Pressing the button once, **[SINGLE]** is displayed and the remaining time of the current track is displayed.
Pressing once more, **[TOTAL]** is displayed, and total playing time of remaining tracks is displayed. However, when programmed play is in progress, the total remaining time of the program is displayed.
Press the button once again to return to the normal display of the elapsed playback time of the current track.

13 Index Button (INDEX)

- Press this button to start playback from an index within a track. Use the number buttons to specify the index number.

14 Program/Direct Button (PROG/DIRECT)

- Press this button when you want to enter tracks for programmed playback. (Refer to page 7 for details.)

15 Number Buttons (1, 2, 3, 4, 5, 6, 7, 8, 9 and 10)

- Use these buttons for the direct search and program memory functions.
For direct search, press for example button **[3]** if you want to hear track number 3. For track number 12, press **[+10]** then **[2]**. To program tracks, press the PROG/DIRECT button to set to the program mode.

16 +10 Button (+10)

- Press this button first when selecting track numbers over 10. Use it together with the number buttons. For example, to select track number **[15]**, press **[+10]** then **[5]**.
For track number 33, press **[+10]** three times, then press **[3]**.

17 Play Button (▶ PLAY)

- Press this button to start playback of a disc.
- When this button is pressed, **[▶PLAY]** is displayed, and the track number being played is displayed together with the elapsed playback time of the track.
- Tracks are shown on the calendar display. Once a track has been played, the corresponding track number goes out on the calendar display.

18 Pause Button (|| PAUSE)

- Press this button to stop playback temporarily.
- If this button is pressed during playback, playback is stopped temporarily, the **[▶PLAY]** indicator goes out and the **[||PAUSE]** indicator lights.
- Press this button or the play button (▶ PLAY) again to continue playback.

19 Automatic Search Reverse Button (⏮)

- Press this button to return the pickup to the beginning of the present track. Press again to return to other tracks.
- By pressing the button a number of times, the pickup will move back the corresponding number of tracks.

20 Automatic Search Forward Button (⏭)

- Press this button to move the pickup forward to the beginning of the next track. Press again to move ahead to other tracks.
- By pressing the button a number of times, the pickup will advance the corresponding number of tracks.

21 Stop Button (■ STOP)

- Press this button to stop playback.
The disc will stop rotating, and the number of tracks and total playing time of the disc are displayed on the TRACK NO. and TIME displays, respectively.
- In case programmed playback is engaged when this button is pressed, the number of tracks and total playing time of the program are displayed.
- If this button is pressed in the stop mode, the program memory is cleared.

22 Manual Search Reverse Button (⏪)

- Press this button during playback for fast reverse search. As long as the button is kept pressed, music signals are played back faster than normal.
- Pressing this button when the pause mode is engaged, you can quickly reverse the pickup to a desired position, three times faster compared to manual reverse search during playback. During this time, no sound is heard.

23 Manual Search Forward Button (⏩)

- Press this button during playback for fast forward search. As long as the button is kept pressed, music signals are played back faster than normal.
- Pressing this button when the pause mode is engaged, you can quickly forward the pickup to a desired position, three times faster compared to manual forward search during playback. During this time, no sound is heard.

24 Call Button (CALL)

- Press this button to check the tracks which have been programmed.

25 Headphones Jack (PHONES)

- For private listening, you can connect your headphones to this jack. Do not raise the volume level too much when listening through headphones. (Headphones are sold separately.)

26 Volume Control (PHONES LEVEL)

- Use this control to adjust the output level (volume) of the headphones.

27 Output Terminal (VARIABLE)

- Connect these jacks to the input jacks on your amplifier. (Refer to page 6 for details on the connections.)

28 Digital Output Jack (COAXIAL)

- This jack outputs digital data.
- We recommend using a 75-ohm pin cord (available in stores) for connections.

Continuous Operation

If the automatic search reverse button **[⏮]**, the automatic search forward button **[⏩]**, the CALL button **[CALL]**, or the +10 button **[+10]** are held in, the function of that button will be repeated.

CONNECTION

(1) Connecting the Output Terminal (VARIABLE)

Use the included pin cords to connect the left (L) and right (R) output terminal (VARIABLE) of the DCD-820 to the CD, AUX, or TAPE PLAY left (L) and right (R) input jacks of the amplifier.

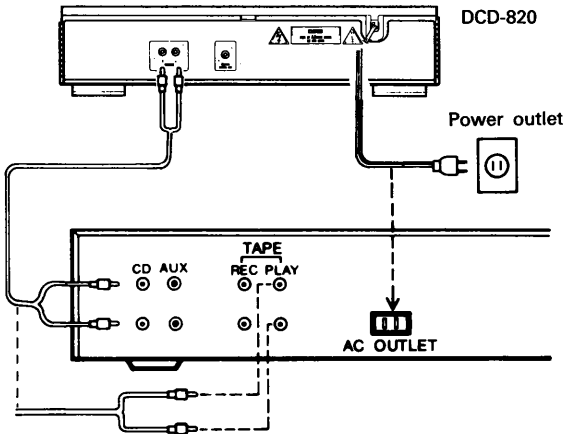

(2) Connecting the Digital Output Jack (COAXIAL)

Use a 75-ohm pin cord to connect the digital output jack (COAXIAL) of the DCD-820 to the digital input jack (COAXIAL) on a digital processor or D/A unit, available in stores.

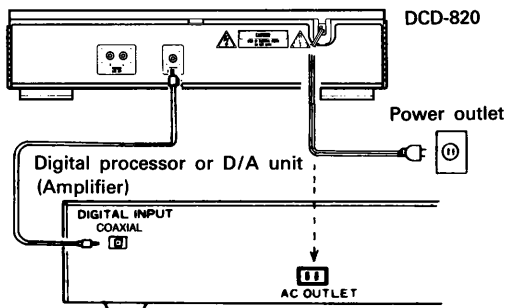

Connection Precautions

- Before proceeding with connections or disconnections of cables and power cords, be sure to turn all system components off.
- Ensure that all cables are connected properly to the L (left) and R (right) jacks.
- Insert plugs fully into the terminals.
- Connect the output jacks to the amplifier CD, AUX or TAPE PLAY input jacks.

OPENING AND CLOSING THE DISC HOLDER AND LOADING A DISC

Opening and closing the disc holder (This operation only works while the power is on.)

1. Press the power switch (POWER) to turn on the power.
2. Press the open/close button (▲ OPEN/CLOSE).

How to load a disc

- Make sure the disc holder is completely open.
- Hold the disc by the edges and place it on the disc tray. (Do not touch the signal surface, i.e., the glossy side.)
- When using 12 cm. diameter discs, make sure the outer edge matches the tray guide circumference (Fig. 1), and when using CD singles (8 cm. diameter) match the outer edge with the inner tray guide circumference. (Fig. 2)
- Press the open/close button (▲ OPEN/CLOSE) to close the disc holder.
- When the disc holder is closed, the disc is read and after a few seconds the number of tracks and total playing time are displayed on the TRACK NO. and TIME displays, respectively.

- When the disc holder is open and a disc is loaded, you may also press the play (▶ PLAY) or pause (⏸ PAUSE) button to close the disc holder. (If the play button (▶ PLAY) is pressed, playback will start immediately upon the disc contents having been read.)

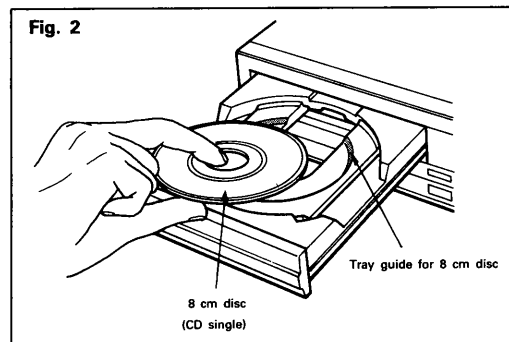
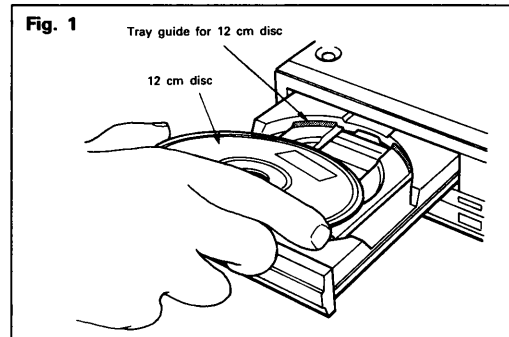

Caution:

- If your finger should get caught in the disc holder when it closes, press the open/close button (▲ OPEN/CLOSE).
- Do not place any foreign objects on the disc tray, and do not place more than one disc on the tray at a time. Otherwise malfunction may occur.
- Do not push in the disc tray manually when the power is off as this may cause malfunction and damage the CD player.

NORMAL CD PLAYBACK

(1) Starting Playback

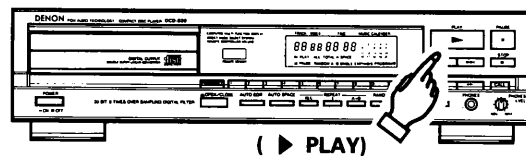

1. Press the power switch (POWER) to turn on the power.
2. Load the disc you want to play.
- When the disc holder is closed, the disc is read and the number of tracks and total playing time of the disc are displayed.
3. Press the play button (▶ PLAY).

(2) Stopping Playback

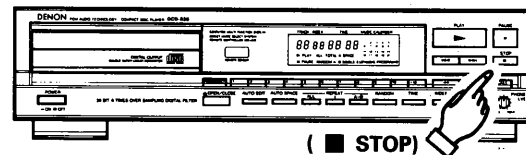

1. Press the stop button (■ STOP).
- When all tracks have been played on a disc, playback will stop by itself.

Precautions:

- If no disc has been loaded or the disc has been placed upside down, all indicators will light.
- When the information on the disc cannot be read correctly, for example due to dust or dirt on the disc, the indicators will read as shown below. Nothing will be shown on the TRACK NO. and TIME displays, and it may take quite a while to read the disc.
- When PLAY, PAUSE or NUMBER buttons are pushed just after turning on the unit with a disc inserted, the "TRACK INDEX TIME M S" display might not be indicated in the window. This is normal. In this case, push the STOP button to light-up the display and then, push your necessary function button.

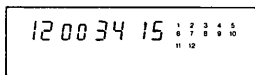

Normal display

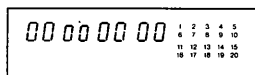

Improper display

ADVANCED CD PLAYBACK

1 Playing a Specific Track Direct Search **Number buttons**

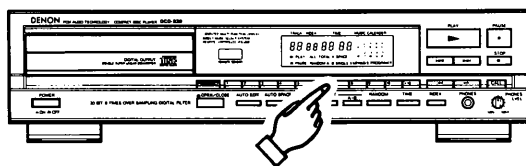

(Number buttons)

- Use the number buttons and the +10 button to input the number of the desired track. For example, to play track number 4, press [4], and to play track number 12, press [+10] and [2]. Playback will begin from that track.

2 Advancing to the next track during playback **Automatic Search**

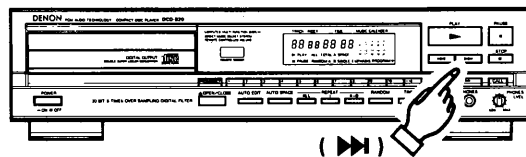

(▶▶)

- Press the Automatic search forward button (▶▶) during playback. The pickup will advance to the beginning of the next track and playback will continue. Pressing the button several times will forward the pickup the corresponding number tracks.

3 Returning to the beginning of the current track during playback **Automatic Search**

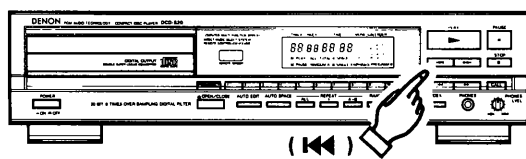

(◀◀)

- Press the Automatic search reverse button (◀◀) during playback. The pickup will return to the beginning of the current track and playback will continue. Pressing the button several times will return the pickup the corresponding number tracks.

4 Finding Sections Within a Track **Index Search**

- With this function, you can find and play from the beginning of sections within the track marked by index numbers.

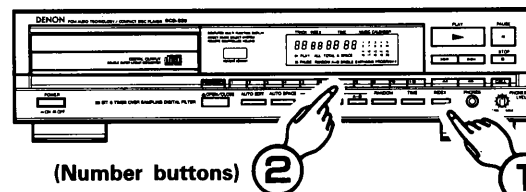

(Number buttons)

2

(INDEX)

- 1 "--" appears on the TRACK NO. display when the INDEX button is pressed.
- 2 Input the track number using the number buttons. Next, "--" appears on the INDEX display. Input the desired index number, and playback will start from that index number. For example, to start from index 2 on track number 3, press INDEX, 3, then 2.

Indexes

- Indexes are numbers which are assigned to sections within a track. Check the disc's explanatory notes for the index numbers.
- If you input an index number not on the disc, playback will start from the last index number on the track.

5 Playing Specific Tracks in a Specific Order **Programmed Play**

- With this function, you can choose any of the tracks on the disc and program them to play in any order.
- Programming is possible with the disc holder open.
- Up to 20 tracks can be programmed.
- The programmed tracks are shown on the calendar.

(1) Programming

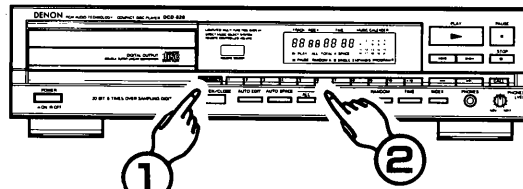

(PROG/DIRECT)

(Number buttons)

- Press the PROG/DIRECT button so that the PROGRAM indicator lights, then use the number buttons and the +10 button to program the tracks. For example, to program tracks 3, 12, and 7, press [PROG/DIRECT], [3], [+10], [2], and [7].

The corresponding track number lights on the calendar each time a track is programmed, the track number is displayed on the TRACK NO. display, the number of tracks programmed is displayed on the INDEX display, and the total playing time of the programmed tracks is displayed on the TIME display. A few seconds after the last track has been programmed, the total number of tracks programmed is displayed on the TRACK NO. display and the total playing time of the programmed tracks is displayed on the TIME display.

(2) Checking the Programmed Tracks

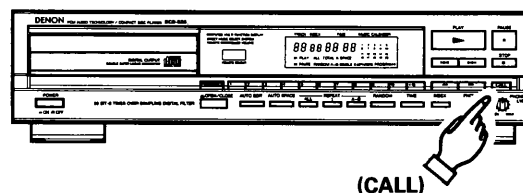

(CALL)

- Press the CALL button. The programmed tracks are displayed in order on the TRACK NO. display each time the CALL button is pressed.

(3) Playing the Programmed Tracks

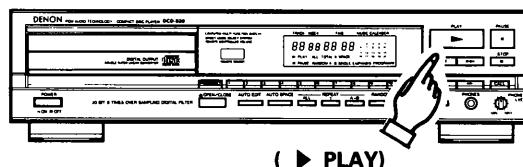

(▶ PLAY)

- Press the (▶ PLAY) button to play the tracks in the programmed order.

(4) Clearing the Program

- The entire program is cleared when the PROG/DIRECT button is pressed again. The program is also cleared when the (OPEN/CLOSE) button is pressed.
- If the PROG/DIRECT button is pressed during programmed play, the program is cleared and playback continues normally through to the last track on the disc.

NOTES

- If programming is done in the play or pause mode, the track currently playing is programmed at the first position. Other tracks can be added to the program, but the number of programmed tracks and the playing time will not be displayed.
- Direct search is not possible during programmed play. If the number buttons are pressed, that track is added to the end of the program.
- Programming is possible with the disc holder open. Track numbers greater than the number of tracks recorded on the disc can be programmed, but will be automatically cleared before playback begins.
- The remaining time per track will only be displayed for track numbers 1 through 20.
- The total program time and remaining program time are not displayed if tracks greater than track number 20 are programmed.

(6) Repeating playback of all tracks Repeat All

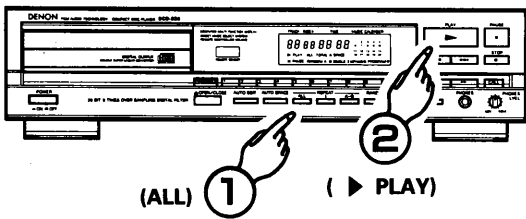

- ① Press the repeat all button (ALL).
 - ② Press the play button (▶ PLAY).
- Pressing the repeat all tracks button (ALL), [ALL] is displayed.
 - Steps ① and ② above may be reversed.
 - To cancel repeat playback of all tracks, press the repeat all button (ALL) once more.
 - Pressing the repeat all button (ALL) during programmed playback, playback of the tracks entered into the memory will be repeated.

(7) Repeating a Single Track 1-track Repeat

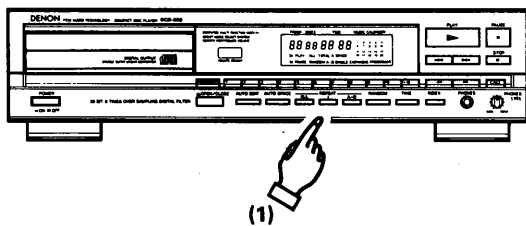

- Press this button if you want to hear a track repeatedly.

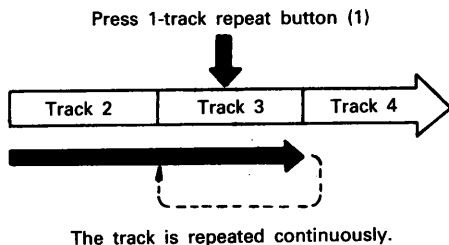

- When the 1-track repeat button (1) is pressed during playback, only the number of the track currently playing will remain lit on the calendar, as long as the track number is not over 20, and that track will be repeated.
- If the track number is 21 or over, the 1-track repeat function will work, but nothing will be lit on the calendar.
- When the 1-track repeat button (1) is pressed in the stop mode, track number 1 lights on the calendar and the 1 track repeat function is possible. To start, press the (▶ PLAY) button.
- To cancel 1-track repeat, press the 1-track repeat button (1) once again. Normal playback will resume.

NOTE:

1-track repeat is possible during the all track repeat function (when the ALL indicator is on) by pressing the 1-track repeat button (1). When this is done, the ALL indicator will remain lit, and the all track repeat mode will resume when the 1-track repeat button (1) is pressed again.

(8) Repeating playback of a desired interval A-B Repeat

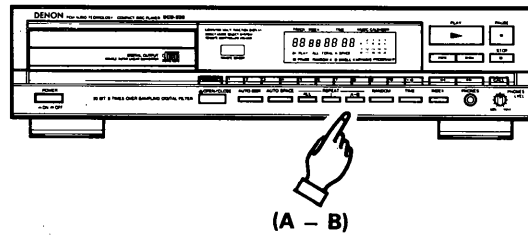

1. Start playback and press the A-B button when you reach the starting point of the interval. The [A-B] indicator starts blinking.
 2. Continue playback or advance the pickup using the Automatic search forward button (▶▶) or manual search forward button (▶▶) until the ending point is reached. Then press the A-B button once more. The [A-B] indicator will light.
- The pickup will now return to the starting point and repeat playback of the selected interval.
 - This interval will be repeated until the A-B repeat mode is cancelled by pressing the A-B repeat button. The [A-B] indicator goes out.
 - A-B repeat playback is not possible during programmed playback.

(9) Pausing playback at any point Pause

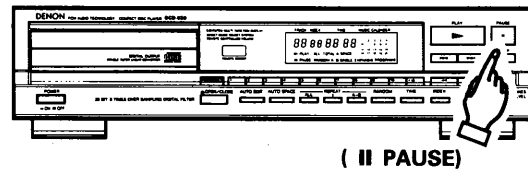

- Playback can be temporarily halted and then continued from the same point in the track.
1. Press the pause button (|| PAUSE) during playback.
 2. To continue playback, press the play button (▶ PLAY) or the pause button (|| PAUSE) once more.

(10) Audible quick search Manual Search

- Using this function, you can cue to a desired point within a track, either in the forward or reverse direction.
- Release the manual search button (◀◀ or ▶▶) when the desired point has been reached. Normal playback then continues.

(1) Manual Search Forward

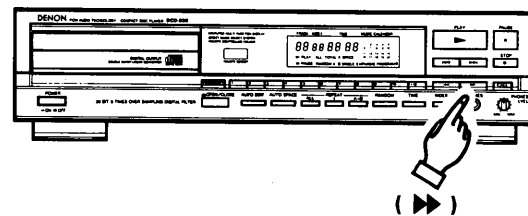

1. Press the manual search forward button (▶▶) during playback. Playback of the track is sped up.
 - As a reference, the current track number and elapsed playback time within the track are displayed.
 - Manual search forward is approximately three times faster when engaged during the pause state compared to playback. In this case, no sound is heard however.
 - If the manual search forward button (▶▶) is kept pressed after the end of the final track on the disc is reached, (JJ) is displayed and manual search stops. To return to another point, press the manual search reverse button (◀◀) until (JJ) disappears.

(2) Manual Search in Reverse

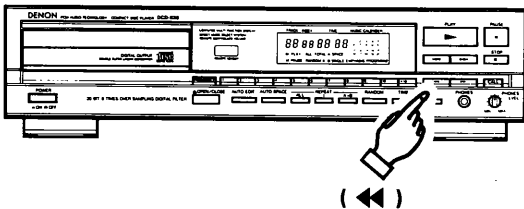

1. Press the manual search reverse button (◀◀) during playback. Reverse playback of the track is sped up.
 - As a reference, the current track number and elapsed playback time within the track are displayed.
 - Manual search in reverse is approximately three times faster when engaged during the pause state compared to playback. In this case, no sound is heard however.
 - If the manual search reverse button (◀◀) is kept pressed after the beginning of the first track on the disc is reached, (CC) is displayed and manual search stops. To return to another point, press the manual search forward button (▶▶) until (CC) disappears.

11 Inserting blanks between tracks Auto Space

- This is convenient feature that will insert 4-second blanks between tracks, which can be used when recording compact discs on tape.

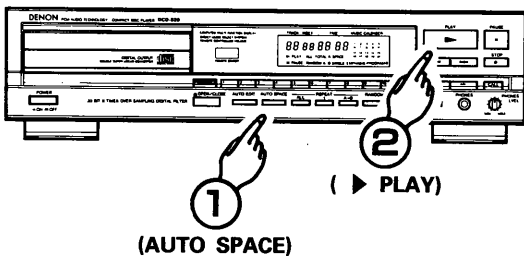

1. Pressing the auto space button (AUTO SPACE) will cause the [A. SPACE] indicator to light.
2. Press the play button (▶ PLAY) to start playback. When a track has been played to its end, a 4-second silence is made before the next track starts playing.
3. Press the auto space button (AUTO SPACE) again to cancel the function.

12 Searching and Pausing at the Beginning of the Track Pause

(1) With Direct Search

- In this case, the set pauses at the beginning of the track found with the direct search operation.

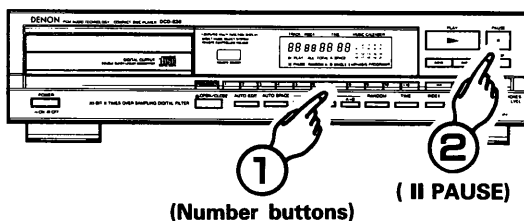

1. Press the number button(s) for the desired track.
2. Press the (|| PAUSE) button.
 - To start playback, press the (▶ PLAY) or (|| PAUSE) button.

(2) With Program Search

- Press the (|| PAUSE) button after the program search operation is completed. The set will pause at the beginning of the first programmed track.

13 Playing in Random Order Random Play

- With this function, the tracks recorded on the disc can be played in a completely random order.

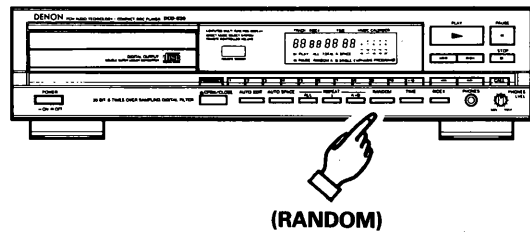

- When the RANDOM button is pressed, the [RANDOM] indicator lights and random play begins automatically.
- If the RANDOM button is pressed when tracks have been programmed, only the programmed tracks will be played, in random order.
- If the RANDOM button is pressed when the repeat function is set, the tracks will be played through once in random order, then played through again in a different order, etc.
- During random play, all of the tracks on the disc are displayed rapidly on the TRACK NO. display, and the track which will be played next cannot be known until playback starts.

NOTE:

- The remaining time in the total mode cannot be displayed during random play.
- If the RANDOM button is pressed when in the auto edit mode, the auto edit mode is cleared.

TIMER-CONTROLLED PLAYBACK

■ Operation

1. Turn on the power of all system components.
2. Set the input selector on the amplifier to correspond to the inputs the CD player is connected to.
3. Make sure a disc has been loaded in the disc holder.
4. Check the time on the timer and then set the desired turn-on time.
5. Turn the audio timer ON.
 - Power is turned off automatically in all components connected to the timer.
6. When the preset turn-on time is reached, power is turned on in the system components, and CD playback starts from the first track.

■ Connection

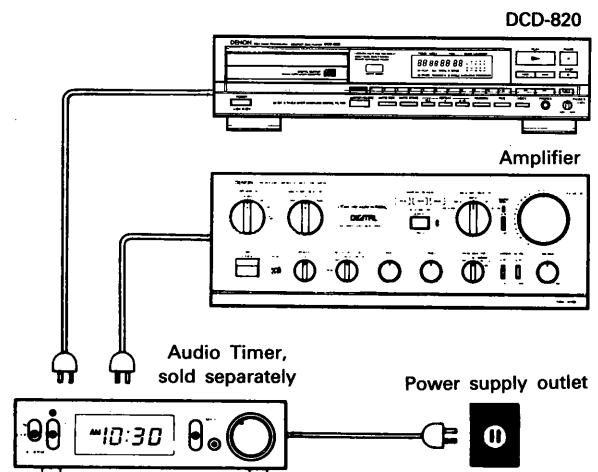

THE COMPACT DISC

1. Precautions on handling compact discs

- Do not allow fingerprints, oil or dust on the surface of the compact disc. If the signal surface is dirty, wipe it off with a soft, dry cloth. Wipe in circular motions from the center and out. Use of DENON's AMC-20/21 CD cleaner is recommended.
- Do not use water, benzene, thinner, record sprays, electrostatic proof chemicals, or silicone-treated cloth to clean discs.
- Always use care when handling discs to prevent damaging the surface, in particular when removing a disc from the case and returning it.
- Do not bend compact discs.
- Do not apply heat to compact discs.
- Do not enlarge the hole in the center of the disc.
- Do not write on the disc and do not attach any labels.

- Condensation will form on the disc surface if it is brought into a warm room from a cold area, such as outdoors during winter. Wait until the condensation disappears. Never dry discs with hair dryers, etc.

2. Precautions on storage

- After playing a disc, always return it to its case.
- Keep discs in the cases when they are not to be played. This will protect them from dust and dirt and prolong their service life.
- Do not store discs in the following places:
 - 1) Places exposed to direct sunlight for a considerable time.
 - 2) Places subject to accumulation of dust or high humidity.
 - 3) Places exposed to high temperatures, such as close to heater outlets.

PLAYBACK USING THE REMOTE CONTROL UNIT

The accessory RC-220 remote control unit can be used to control the CD player from a convenient distance.

(1) Inserting the dry cell batteries

1. Remove the battery cover on the back of the remote control unit.

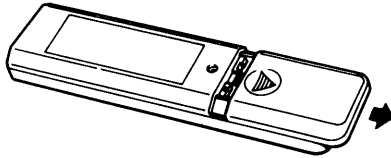

2. Insert two SUM-3 (standard size AAA) dry cell batteries with correct polarity as indicated inside the battery compartment.

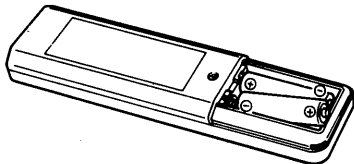

3. Replace the battery cover.

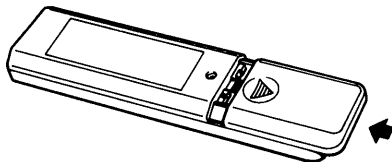

(2) Directions for Use

- Operate the remote control unit while pointing it towards the remote control sensor on the CD player (see below).

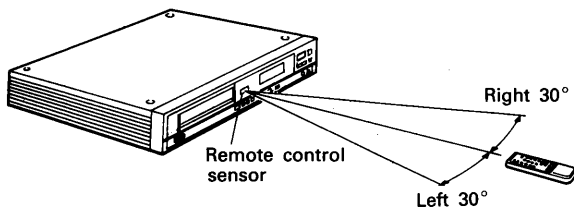

When a remote control signal is received, the remote control indicator on front of the CD player lights briefly.

- The remote control unit can be used at a distance up to 8 meters in a straight line from the CD player. This distance decreases if there are obstructions blocking the signal path or when the remote control unit is operated at an angle from the remote control sensor.
- The buttons on the remote control unit have identical functions with those on the CD player. However, the following functions cannot be remote controlled: Power ON/OFF.

Notes on the Batteries

- The remote control unit uses standard size AAA dry cell batteries.
- The batteries will need to be replaced approximately once a year. Replacement may be necessary earlier depending on how much the remote control unit is used.
- If, in less than a year from the time new batteries were inserted, the remote control fails to operate the CD player from a near-by position, it is time to replace the batteries.
- Insert the batteries properly, following the polarity diagram inside the battery compartment, in other words make sure (+) and (-) terminals are properly aligned.
- Batteries are prone to damage and leakage. Therefore:
 - Do not combine new batteries with used ones.
 - Do not combine different types of batteries.
 - Do not jumper opposite poles of the batteries, expose them to heat, break them open nor expose of them in open fire.
- If the remote control unit is not to be used for a long period of time, remove the batteries from the unit.
- If the batteries have leaked, remove any traces of battery fluid from the battery compartment, wiping thoroughly with a dry cloth. Then insert new batteries.

Notes on Operation

- Do not press identical buttons on the CD player and remote control unit simultaneously as this may cause malfunction.
- The remote control unit may be difficult to operate if the remote control sensor is exposed to strong light, such as direct sunlight or light from fluorescent lamps, or if there are obstacles between the remote control unit and the sensor.
- **Direct track selection**
Using the track number buttons (1 ~ 10, +10), tracks can be directly assigned for playback.
- **Track selection while programming**
Press the program/direct button (PROG/DIRECT) and then the track numbers you wish to enter into the memory.
Example: PROG/DIRECT → 3 → +10 & 1 → 5
(Tracks 3, 11, 5 and so on are entered into the memory.)

Memorized tracks are erased by pressing the program/direct button (PROG/DIRECT).

- **Correct use of the track number buttons**
Direct selection of single-digit tracks is easy by just pressing the desired track number key. For tracks with numbers from 11 and on, first press the +10 button and then a single-digit button. E.g., to select track 22, press the +10 button twice and then press the 2 button.
- **Volume**
When a volume key is pressed, "—" appears in the minutes portion (M) of the TIME display and the level is displayed at the seconds portion (S) for approximately 2 seconds. The maximum level is 0, the minimum -50. There are 50 steps, one step corresponding to about 1.5 dB. After the volume is set, the level is stored in the memory even when the power is turned off. This level will be cleared after approximately 2 days, however, at which time the volume is set to -20.

REMOTE CONTROL UNIT RC-220

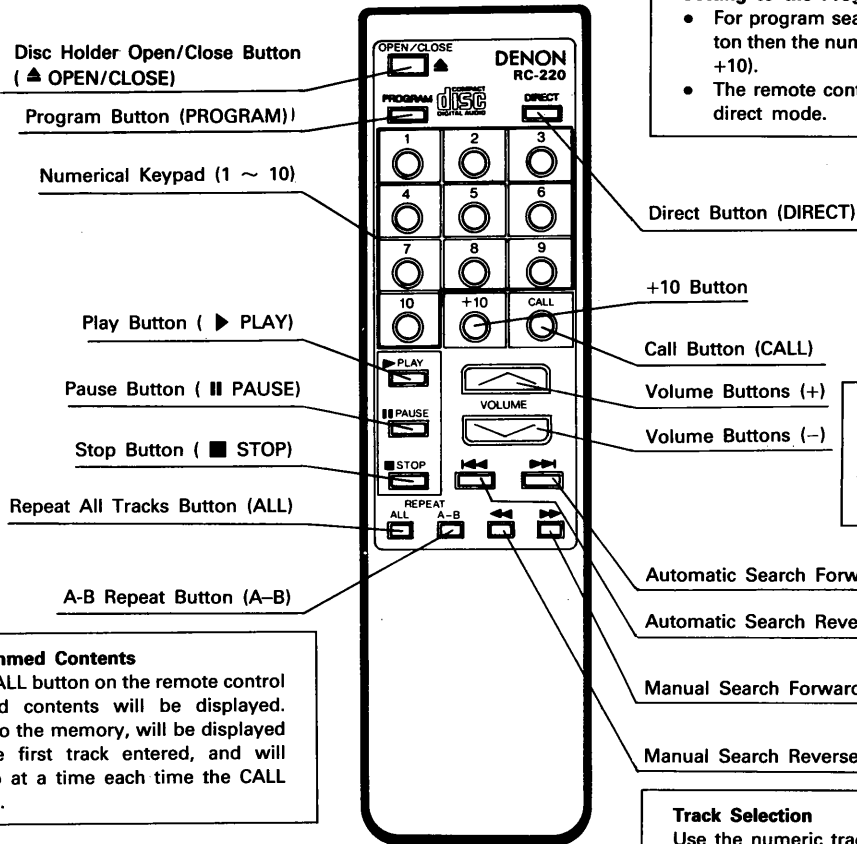

Setting to the Program Mode

- For program search, press the PROGRAM button then the number buttons (1 through 10 and +10).
- The remote control unit is normally set to the direct mode.

The level of the Variable Output Terminal output can be varied. Pressing the (+) button increases the volume and pressing the (-) button decreases the volume.

Checking Programmed Contents

By pressing the CALL button on the remote control unit, programmed contents will be displayed. Tracks entered into the memory, will be displayed starting from the first track entered, and will advance one step at a time each time the CALL button is pressed.

Track Selection

Use the numeric track buttons (1 ~ 10 and +10) while programming and to access a desired track almost instantly. The track search buttons (◀◀ and ▶▶) are best used to advance or return from the current track to the next track.

INSTALLATION PRECAUTIONS

The CD player uses a microcomputer for controlling internal electronic circuits. In the event that the player is used while a near-by tuner or TV is turned on, although unlikely, interference could occur either in the sound from the tuner or the picture of the TV. To avoid this, please take the following precautions.

- Keep the CD player as far away from the tuner or TV set as possible.
- Keep the power cable and connecting cable of the CD player separate from the antenna wires of the tuner and TV.
- Interference is particular likely to occur when an indoor antenna or a 300-ohm feeder cable is used. Thus, use of an outdoor antenna and 75-ohm coaxial cable is strongly recommended.

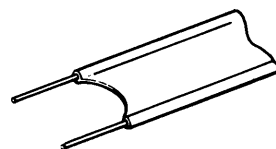

300-ohm feeder cable

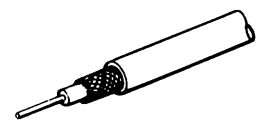

75-ohm coaxial cable

SPECIFICATIONS

AUDIO

No. of Channels: 2 channels
Frequency Response: 2 ~ 20,000 Hz
Dynamic Range: 97 dB
Signal-to-noise Ratio: 102 dB
Harmonic Distortion: 0.004% (1 kHz)
Separation: 98 dB (1 kHz)
Wow & Flutter: Below measurable limit:
(±0.001% W.peak)

Output Voltage: VARIABLE 0~2.0 V
DISCS Compact Disc format

GENERAL CHARACTERISTICS

Power Supply: 50/60 Hz, voltage is shown on rating label
Power Consumption: 12 W
Dimensions: 434 (17.1 in) W × 103 (4.0 in) H ×
315 (12.4 in) D mm
Weight: 4 kg

FUNCTIONS AND DISPLAY

Functions: Direct selection, automatic search,
programmed playback, repeat playback,
manual search, auto space, time mode,
auto edit, emphasis feature

Display: Track number, time, music calendar,
and engaged modes

Others: Headphones jack

REMOTE CONTROL UNIT

Remote Control System: Infrared pulse system

Power Supply: 3 V DC; two SUM-3 (standard size AAA)
dry cell batteries

External Dimensions: 48 (1.9 in) W × 177 (7.0 in) H × 18 (0.7 in) D mm

Weight: 100 g (including batteries)

SUPPLIED ACCESSORIES

Pin-plug connection cord

* Design and specifications are subject to change without notice in the course of product improvement.

SPECIFICATIONS

AUDIO

No. of Channels:	2 channels
Frequency Response:	2 ~ 20,000 Hz
Dynamic Range:	97 dB
Signal-to-noise Ratio:	102 dB
Harmonic Distortion:	0.004% (1 kHz)
Separation:	98 dB (1 kHz)
Wow & Flutter:	Below measurable limit: ($\pm 0.001\%$ W. peak)
Output Voltage:	VARIABLE 0 ~ 2.0 V

DISCS

Compact Disc format

GENERAL CHARACTERISTICS

Power Supply:	50/60 Hz, Voltage is shown on rating label.
Power Consumption:	12 W
Dimensions:	434 (17.1 in) W x 103 (4.0 in) H x 315 (12.4 in) D mm
Weight:	4 kg

FUNCTIONS AND DISPLAY

Functions:	Direct selection, automatic search, programmed playback, repeat playback, manual search, auto space, time mode, auto edit, emphasis feature
Display:	Track number, time, music calendar, and engaged modes
Others:	Headphones jack

REMOTE CONTROL UNIT

Remote Control System:	RC-220 Infrared pulse system
Power Supply:	3 V DC; two SUM-3 (standard size AAA) dry cell batteries
External Dimensions:	48 (1.9 in) W x 177 (7.0 in) H x 18 (0.7 in) D mm
Weight:	100 g (including batteries)

SUPPLIED ACCESSORIES

Pin-plug connection cord

* Design and specifications are subject to change without notice in the course of product improvement.