

DENON

CD PLAYER

DCD-F102

OPERATING INSTRUCTIONS

BEDIENUNGSANLEITUNG

MODE D'EMPLOI

ISTRUZIONI PER L'USO

INSTRUCCIONES DE FUNCIONAMIENTO

GEBRUIKSAANWIJZING

BRUKSANVISNING

■ SAFETY PRECAUTIONS



CAUTION

RISK OF ELECTRIC SHOCK

DO NOT OPEN



CAUTION:
TO REDUCE THE RISK OF ELECTRIC SHOCK, DO NOT REMOVE COVER (OR BACK). NO USER-SERVICEABLE PARTS INSIDE. REFER SERVICING TO QUALIFIED SERVICE PERSONNEL.

 The lightning flash with arrowhead symbol, within an equilateral triangle, is intended to alert the user to the presence of uninsulated "dangerous voltage" within the product's enclosure that may be of sufficient magnitude to constitute a risk of electric shock to persons.

 The exclamation point within an equilateral triangle is intended to alert the user to the presence of important operating and maintenance (servicing) instructions in the literature accompanying the appliance.

WARNING:
TO REDUCE THE RISK OF FIRE OR ELECTRIC SHOCK, DO NOT EXPOSE THIS APPLIANCE TO RAIN OR MOISTURE.

CLASS 1 LASER PRODUCT
 LUOKAN 1 LASERLAITE
 KLAS 1 LASERAPPARAT

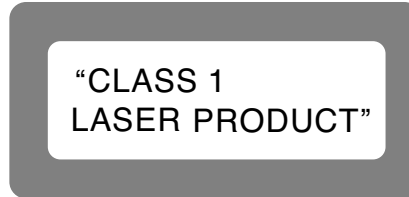

ADVARSEL: USYNLIG LASERSTRÅLING VED ÅBNING, NÅR SIKKERHEDSAFBRYDERE ER UDE AF FUNKTION. UNDGÅ UDSAETTELSE FOR STRÅLING.

VAROITUS! LAITTEEN KÄYTTÄMINEN MUULLA KUIN TÄSSÄ KÄYTTÖOHJEESSA MAINITULLA TAVALLA SAATTAÄ ALTISTAA KÄYTTÄJÄN TURVALLISUUSLUOKAN 1 YLITTÄVÄLLE NÄKYMÄMTTÖMÄLLE LASERSÄTEILYLLE.

WARNING: OM APPARATEN ANVÄNDS PÅ ANNAT SÄTT ÄN I DENNA BRUKSANVISNING SPECIFICERATS, KAN ANVÄNDAREN UTSÄTTAS FÖR OSYNLIG LASERSTRÅLNING SOM ÖVERSKRIDER GRÄNSEN FÖR LASERKLASS 1.

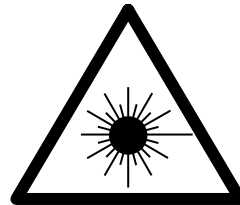





ATTENZIONE: QUESTO APPARECCHIO E' DOTATO DI DISPOSITIVO OTTICO CON RAGGIO LASER. L'USO IMPROPRIO DELL'APPARECCHIO PUO' CAUSARE PERICOLOSE ESPOSIZIONI A RADIAZIONI!

CAUTION:
USE OF CONTROLS OR ADJUSTMENTS OR PERFORMANCE OF PROCEDURES OTHER THAN THOSE SPECIFIED HEREIN MAY RESULT IN HAZARDOUS RADIATION EXPOSURE.
THE SUPER AUDIO CD PLAYER SHOULD NOT BE ADJUSTED OR REPAIRED BY ANYONE EXCEPT PROPERLY QUALIFIED SERVICE PERSONNEL.

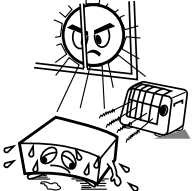
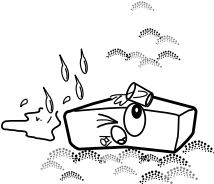
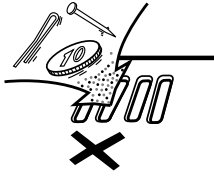
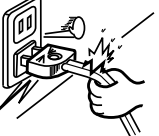
- **DECLARATION OF CONFORMITY**
 We declare under our sole responsibility that this product, to which this declaration relates, is in conformity with the following standards: EN60065, EN55013, EN55020, EN61000-3-2 and EN61000-3-3. Following the provisions of 73/23/EEC, 2004/108/EC and 93/68/EEC Directive.
- **ÜBEREINSTIMMUNGSERKLÄRUNG**
 Wir erklären unter unserer Verantwortung, daß dieses Produkt, auf das sich diese Erklärung bezieht, den folgenden Standards entspricht: EN60065, EN55013, EN55020, EN61000-3-2 und EN61000-3-3. Entspricht den Verordnungen der Direktive 73/23/EEC, 2004/108/EC und 93/68/EEC.
- **DECLARATION DE CONFORMITE**
 Nous déclarons sous notre seule responsabilité que l'appareil, auquel se réfère cette déclaration, est conforme aux standards suivants: EN60065, EN55013, EN55020, EN61000-3-2 et EN61000-3-3. D'après les dispositions de la Directive 73/23/EEC, 2004/108/EC et 93/68/EEC.
- **DICHIARAZIONE DI CONFORMITÀ**
 Dichiariamo con piena responsabilità che questo prodotto, al quale la nostra dichiarazione si riferisce, è conforme alle seguenti normative: EN60065, EN55013, EN55020, EN61000-3-2 e EN61000-3-3. In conformità con le condizioni delle direttive 73/23/EEC, 2004/108/EC e 93/68/EEC. QUESTO PRODOTTO E' CONFORME AL D.M. 28/08/95 N. 548
- **DECLARACIÓN DE CONFORMIDAD**
 Declaramos bajo nuestra exclusiva responsabilidad que este producto al que hace referencia esta declaración, está conforme con los siguientes estándares: EN60065, EN55013, EN55020, EN61000-3-2 y EN61000-3-3. Siguiendo las provisiones de las Directivas 73/23/EEC, 2004/108/EC y 93/68/EEC.
- **EENVORMIGHEIDSVERKLARING**
 Wij verklaren uitsluitend op onze verantwoordelijkheid dat dit produkt, waarop deze verklaring betrekking heeft, in overeenstemming is met de volgende normen: EN60065, EN55013, EN55020, EN61000-3-2 en EN61000-3-3. Volgens de bepalingen van de Richtlijnen 73/23/EEC, 2004/108/EC en 93/68/EEC.
- **ÖVERENSSTÄMMELSESINTYG**
 Härmed intygas helt på eget ansvar att denna produkt, vilken detta intyg avser, uppfyller följande standarder: EN60065, EN55013, EN55020, EN61000-3-2 och EN61000-3-3. Enligt stadgarna i direktiv 73/23/EEC, 2004/108/EC och 93/68/EEC.

NOTE ON USE / HINWEISE ZUM GEBRAUCH / OBSERVATIONS RELATIVES A L'UTILISATION / NOTE SULL'USO / NOTAS SOBRE EL USO / ALVORENS TE GEBRUIKEN / OBSERVERA

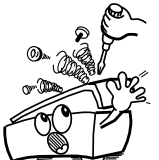
 <ul style="list-style-type: none"> Avoid high temperatures. Allow for sufficient heat dispersion when installed in a rack. Vermeiden Sie hohe Temperaturen. Beachten Sie, daß eine ausreichend Luftzirkulation gewährleistet wird, wenn das Gerät auf ein Regal gestellt wird. Éviter des températures élevées. Tenir compte d'une dispersion de chaleur suffisante lors de l'installation sur une étagère. Evitate di esporre l'unità a temperature alte. Assicuratevi che ci sia un'adeguata dispersione del calore quando installate l'unità in un mobile per componenti audio. Evite altas temperaturas. Permite la suficiente dispersión del calor cuando está instalado en la consola. Vermijd hoge temperaturen. Zorg voor een degelijk hitteafvoer indien het apparaat op een rek wordt geplaatst. Undvik höga temperaturer. Se till att det finns möjlighet till god värmeavledning vid montering i ett rack. 	 <ul style="list-style-type: none"> Keep the apparatus free from moisture, water, and dust. Halten Sie das Gerät von Feuchtigkeit, Wasser und Staub fern. Protéger l'appareil contre l'humidité, l'eau et lapoussière. Tenete l'unità lontana dall'umidità, dall'acqua e dalla polvere. Mantenga el equipo libre de humedad, agua y polvo. Laat geen vochtigheid, water of stof in het apparaat binnendringen. Utsätt inte apparaten för fukt, vatten och damm. 	 <ul style="list-style-type: none"> Do not let foreign objects into the apparatus. Keine fremden Gegenstände in das Gerät kommen lassen. Ne pas laisser des objets étrangers dans l'appareil. E' importante che nessun oggetto è inserito all'interno dell'unità. No deje objetos extraños dentro del equipo. Laat geen vreemde voorwerpen in dit apparaat vallen. Se till att främmande föremål inte tränger in i apparaten. 	<p>CAUTION:</p> <ul style="list-style-type: none"> The ventilation should not be impeded by covering the ventilation openings with items, such as newspapers, tablecloths, curtains, etc. No naked flame sources, such as lighted candles, should be placed on the apparatus. Attention should be drawn to the environmental aspects of battery disposal. Do not expose the set to dripping or splashing fluids. No objects filled with liquids, such as vases, shall be placed on the apparatus. <p>ACHTUNG:</p> <ul style="list-style-type: none"> Die Belüftung sollte auf keinen Fall durch das Abdecken der Belüftungsöffnungen durch Gegenstände wie beispielsweise Zeitungen, Tischtücher, Vorhänge o. Ä. behindert werden. Auf dem Gerät sollten keinerlei direkten Feuerquellen wie beispielsweise angezündete Kerzen aufgestellt werden. Bitte beachten Sie bei der Entsorgung der Batterien die geltenden Umweltbestimmungen. Das Gerät sollte keinerlei Flüssigkeit, also keinem Tropfen oder Spritzen ausgesetzt werden. Auf dem Gerät sollten keinerlei mit Flüssigkeit gefüllten Behälter wie beispielsweise Vasen aufgestellt werden.
 <ul style="list-style-type: none"> Handle the power cord carefully. Hold the plug when unplugging the cord. Gehen Sie vorsichtig mit dem Netzkabel um. Halten Sie das Kabel am Stecker, wenn Sie den Stecker herausziehen. Manipuler le cordon d'alimentation avec précaution. Tenir la prise lors du débranchement du cordon. Manneggiate il filo di alimentazione con cura. Agite per la spina quando scollegate il cavo dalla presa. Maneje el cordón de energía con cuidado. Sostenga el enchufe cuando desconecte el cordón de energía. Hanteer het netsnoer voorzichtig. Houd het snoer bij de stekker vast wanneer deze moet worden aan- of losgekoppeld. Hantera nätkabeln varsamt. Håll i kabeln när den kopplas från el-uttaget. 	 <ul style="list-style-type: none"> Unplug the power cord when not using the apparatus for long periods of time. Wenn das Gerät eine längere Zeit nicht verwendet werden soll, trennen Sie das Netzkabel vom Netzstecker. Débrancher le cordon d'alimentation lorsque l'appareil n'est pas utilisé pendant de longues périodes. Disinnestate il filo di alimentazione quando avete l'intenzione di non usare il filo di alimentazione per un lungo periodo di tempo. Desconecte el cordón de energía cuando no utilice el equipo por mucho tiempo. Neem altijd het netsnoer uit het stopcontact wanneer het apparaat gedurende een lange periode niet wordt gebruikt. Koppla ur nätkabeln om apparaten inte kommer att användas i lång tid. 	 <ul style="list-style-type: none"> Do not let insecticides, benzene, and thinner come in contact with the apparatus. Lassen Sie das Gerät nicht mit Insektiziden, Benzin oder Verdünnungsmitteln in Berührung kommen. Ne pas mettre en contact des insecticides, du benzène et un diluant avec l'appareil. Assicuratevvi che l'unità non venga in contatto con insetticidi, benzolo o solventi. No permita el contacto de insecticidas, gasolina y diluyentes con el equipo. Laat geen insectenverdelgende middelen, benzine of ververdunner met dit apparaat in contact komen. Se till att inte insektsmedel på spraybruk, bensin och thinner kommer i kontakt med apparatens hölje. 	<p>ATTENTION:</p> <ul style="list-style-type: none"> La ventilation ne doit pas être gênée en recouvrant les ouvertures de la ventilation avec des objets tels que journaux, rideaux, tissus, etc. Aucune flamme nue, par exemple une bougie, ne doit être placée sur l'appareil. Veillez à respecter l'environnement lorsque vous jetez les piles usagées. L'appareil ne doit pas être exposé à l'eau ou à l'humidité. Aucun objet contenant du liquide, par exemple un vase, ne doit être placé sur l'appareil. <p>PRECAUZIONI:</p> <ul style="list-style-type: none"> Le aperture di ventilazione non devono essere ostruite coprendole con oggetti, quali giornali, tovaglie, tende e così via. Non posizionare sull'apparecchiatura fiamme libere, come ad esempio le candele accese. Prestare attenzione agli aspetti legati alla tutela dell'ambiente quando si smaltisce la batteria. L'apparecchiatura non deve essere esposta a gocciolii o spruzzi. Non posizionare sull'apparecchiatura nessun oggetto contenete liquidi, come ad esempio i vasi. <p>PRECAUCIÓN:</p> <ul style="list-style-type: none"> La apertura de ventilación no debe quedar obstruida por hacerse cubierto las aperturas con objetos como periódicos, manteles, cortinas, etc. No debe colocarse sobre el aparato ninguna fuente inflamable sin protección, como velas encendidas. A la hora de deshacerse de las pilas, respete la normativa para el cuidado del medio ambiente. No se expondrá el aparato al goteo o salpicaduras cuando se utilice. No se colocarán sobre el aparato objetos llenos de líquido, como jarrros.
 <p>* (For apparatuses with ventilation holes)</p> <ul style="list-style-type: none"> Do not obstruct the ventilation holes. Die Belüftungsöffnungen dürfen nicht verdeckt werden. Ne pas obstruer les trous d'aération. Non coprite i fori di ventilazione. No obstruya los orificios de ventilación. De ventilatieopeningen mogen niet worden beblokkeerd. Täpp inte till ventilationsöppningarna. 	 <p>* (For apparatuses with ventilation holes)</p> <ul style="list-style-type: none"> Do not obstruct the ventilation holes. Die Belüftungsöffnungen dürfen nicht verdeckt werden. Ne pas obstruer les trous d'aération. Non coprite i fori di ventilazione. No obstruya los orificios de ventilación. De ventilatieopeningen mogen niet worden beblokkeerd. Täpp inte till ventilationsöppningarna. 	 <ul style="list-style-type: none"> Never disassemble or modify the apparatus in any way. Versuchen Sie niemals das Gerät auseinander zu nehmen oder auf jegliche Art zu verändern. Ne jamais démonter ou modifier l'appareil d'une manière ou d'une autre. Non smontate mai, nè modificate l'unità in nessun modo. Nunca desarme o modifique el equipo de ninguna manera. Nooit dit apparaat demonteren of op andere wijze modiëren. Ta inte isär apparaten och försök inte bygga om den. 	<p>WAARSCHUWING:</p> <ul style="list-style-type: none"> De ventilatie mag niet worden belemmerd door de ventilatieopeningen af te dekken met bijvoorbeeld kranten, een tafelkleed, gordijnen, enz. Plaats geen open vlammen, bijvoorbeeld een brandende kaars, op het apparaat. Houd u steeds aan de milieuvoorschriften wanneer u gebruikte batterijen wegdoet. Stel het apparaat niet bloot aan druppels of spatten. Plaats geen voorwerpen gevuld met water, bijvoorbeeld een vaas, op het apparaat. <p>OBSERVERA:</p> <ul style="list-style-type: none"> Ventilationen bör inte förhindras genom att täcka för ventilationsöppningarna med föremål såsom tidningar, bordsdukar, gardiner osv. Inga blottade brandkällor, såsom tända ljus, bör placeras på apparaten. Tänk på miljöaspekterna när du bortskaffar batteri. Apparaten får inte utsättas för vätska. Inga objekt med vätskor, såsom vaser, får placeras på apparaten.

A NOTE ABOUT RECYCLING:

This product's packaging materials are recyclable and can be reused. Please dispose of any materials in accordance with the local recycling regulations.

When discarding the unit, comply with local rules or regulations.

Batteries should never be thrown away or incinerated but disposed of in accordance with the local regulations concerning chemical waste.

This product and the accessories packed together constitute the applicable product according to the WEEE directive except batteries.

**HINWEIS ZUM RECYCLING:**

Das Verpackungsmaterial dieses Produktes ist für zum Recyceln geeignet und kann wieder verwendet werden. Bitte entsorgen Sie alle Materialien entsprechend der örtlichen Recycling-Vorschriften.

Beachten Sie bei der Entsorgung des Gerätes die örtlichen Vorschriften und Bestimmungen.

Die Batterien dürfen nicht in den Hausmüll geworfen oder verbrannt werden; bitte geben Sie die Batterien gemäß örtlichen Bestimmungen an den Sammelstellen oder Sondermüllplätzen ab.

Dieses Produkt zusammen mit den Zubehörteilen ist das geltende Produkt der WEEE-Direktive, davon ausgenommen sind die Batterien.

UNE REMARQUE CONCERNANT LE RECYCLAGE:

Les matériaux d'emballage de ce produit sont recyclables et peuvent être réutilisés. Veuillez disposer de tout matériau conformément aux règlements de recyclage locaux.

Lorsque vous mettez cet appareil au rebut, respectez les lois ou réglementations locales.

Les piles ne doivent jamais être jetées ou incinérées, mais mises au rebut conformément aux règlements locaux concernant les déchets chimiques.

Ce produit et les accessoires emballés ensemble sont des produits conformes à la directive DEEE sauf pour les piles.

NOTA RELATIVA AL RICICLAGGIO:

I materiali di imballaggio di questo prodotto sono riutilizzabili e riciclabili. Smaltire i materiali conformemente alle normative locali sul riciclaggio.

Per smaltire l'unità, osservare la normativa in vigore nel luogo di utilizzo.

Non gettare le batterie, né incenerirle, ma smaltirle conformemente alla normativa locale sui rifiuti chimici.

Questo prodotto e gli accessori inclusi nell'imballaggio sono applicabili alla direttiva RAEE, ad eccezione delle batterie.

ACERCA DEL RECICLAJE:

Los materiales de embalaje de este producto son reciclables y se pueden volver a utilizar. Disponga de estos materiales siguiendo los reglamentos de reciclaje de su localidad.

Cuando se deshaga de la unidad, cumpla con las reglas o reglamentos locales.

Las pilas nunca deberán tirarse ni incinerarse. Deberá disponer de ellas siguiendo los reglamentos de su localidad relacionados con los desperdicios químicos.

Este producto junto con los accesorios empacados es el producto aplicable a la directiva RAEE excepto pilas.

EEN AANTEKENING WAT BETREFT HET RECYCLEREN:

Het inpakmateriaal van dit product is recycleerbaar en kan opnieuw gebruikt worden. Er wordt verzocht om zich van elk afvalmateriaal te ontdoen volgens de plaatselijke voorschriften.

Volg voor het wegdoen van de speler de voorschriften voor de verwijdering van wit- en bruingoed op.

Batterijen mogen nooit worden weggegooid of verbrand, maar moeten volgens de plaatselijke voorschriften betreffende chemisch afval worden verwijderd.

Op dit product en de meegeleverde accessoires, m.u.v. de batterijen is de richtlijn voor afgedankte elektrische en elektronische apparaten (WEEE) van toepassing.

EN KOMMENTAR OM ÅTERVINNING:

Produktens emballage är återvinningsbart och kan återanvändas. Kassera det enligt lokala återvinningsbestämmelser. När du kasserar enheten ska du göra det i överensstämmelse med lokala regler och bestämmelser.

Batterier får absolut inte kastas i soporna eller brännas. Kassera dem enligt lokala bestämmelser för kemiskt avfall.

Denna apparat och de tillbehör som levereras med den är de som uppfyller gällande WEEE-direktiv, med undantag av batterierna.

CAUTION:

To completely disconnect this product from the mains, disconnect the plug from the wall socket outlet.

The mains plug is used to completely interrupt the power supply to the unit and must be within easy access by the user.

VORSICHT:

Um dieses Gerät vollständig von der Stromversorgung abzutrennen, trennen Sie bitte den Netzstecker von der Wandsteckdose ab.

Die Hauptstecker werden verwendet, um die Stromversorgung zum Gerät völlig zu unterbrechen; er muss für den Benutzer gut und einfach zu erreichen sein.

PRECAUTION:

Pour déconnecter complètement ce produit du courant secteur, débranchez la prise de la prise murale.

La prise secteur est utilisée pour couper complètement l'alimentation de l'appareil et l'utilisateur doit pouvoir y accéder facilement.

ATTENZIONE:

Per scollegare definitivamente questo prodotto dalla rete di alimentazione elettrica, togliere la spina dalla relativa presa.

La spina di rete viene utilizzata per interrompere completamente l'alimentazione all'unità e deve essere facilmente accessibile all'utente.

PRECAUCIÓN:

Para desconectar completamente este producto de la alimentación eléctrica, desconecte el enchufe del enchufe de la pared.

El enchufe de la alimentación se utiliza para interrumpir por completo el suministro de alimentación a la unidad y debe de encontrarse en un lugar al que el usuario tenga fácil acceso.

VOORZICHTIGHEID:

Om de voeding van dit product volledig te onderbreken moet de stekker uit het stopcontact worden getrokken.

De netstekker wordt gebruikt om de stroomtoevoer naar het toestel volledig te onderbreken en moet voor de gebruiker gemakkelijk bereikbaar zijn.

FÖRSIKTIHETSMÅTT:

Koppla loss stickproppen från eluttaget för att helt skilja produkten från nätet.

Stickproppen används för att helt bryta strömförsörjningen till apparaten, och den måste vara lättillgänglig för användaren.

Getting Started

Thank you for purchasing this DENON CD Player. Please read the operation instructions thoroughly in order to acquaint yourself with the CD player and achieve maximum satisfaction from it.

Be sure to keep these instructions for future reference, should any questions or problems arise.

Contents

Getting Started

Accessories	2
Before using	2
About discs	
Discs usable on this set	2
Holding discs	2
Loading discs	2
Cautions on loading discs	3
Cautions on handling	3
Cautions on storing discs	3
Cleaning discs	3
Part names and functions	
Front panel	4
Display	4
Rear panel	5
Recommended system layout	5

Connections

Cable indications	5
Connections [System connections]	6

Operation

Turning the power on	7
Loading discs	7
Starting playback	7
To stop playback	7
To pause playback	7
Fast-forwarding (Search)	8
Fast-reversing (Search)	8
Moving to the beginning of tracks (Skip)	8
Playing the desired track (Direct play)	8
Listening to specific tracks in a specific order (Programmed play)	8, 9
Listening in random order (Random playback)	9
Listening to tracks repeatedly (Repeat play)	
Listening to a specific track repeatedly (1-track repeat play)	9
Listening to all the tracks repeatedly (All-track repeat play)	9
Cuing and stopping playback (Pause)	
Cuing with direct searching	9
Cuing with programmed searching	9
Playing MP3 or WMA (Windows Media® Audio) files	
Before playing MP3 or WMA files	10
Playing MP3 or WMA files	11
Listening to MP3 or WMA files in random order (Random folder/disc play)	11
Listening to MP3 or WMA files repeatedly (Repeat folder/disc play)	12

System Operations

System remote control unit	13
Auto power on function	14
Auto function selection	14
CD synchronized recording	14
Timer function	14
Edit function	15

Others

Troubleshooting	16
Specifications	16

Getting Started

Accessories

Check that the following parts are attached in addition to the main unit:

- ① Operating instructions1
- ② Service station list.....1
- ③ Pin-plug cable (Cable length: Approx. 0.6 m).....1
- ④ System cable (Cable length: Approx. 0.5 m)1



Before using

Pay attention to the following before using this unit:

- **Moving the unit.**
To prevent short-circuits or damaged wires in the connection cables, always unplug the power supply cord and disconnect the connection cables between all other audio components when moving the unit.
- **Cautions on using mobile phones.**
Using a mobile phone near this unit may result in noise. If so, move the mobile phone away from this unit when it is in use.
- **Condensation (dew).**
Water droplets may condense on internal operation parts if the set is brought into a heated room from the cold outdoors or when the room is heated rapidly. If this happens, the set may not operate properly.
- **Should condensation occur.**
The condensation will evaporate in one hour or less, at which time the system will function normally.
- **Before turning the power operation switch on.**
Check once again that all connections are correct and that there are not problems with the connection cables. Always set the power operation switch to the standby position before connecting and disconnecting connection cables.
- **Store these instructions in a safe place.**
After reading, store this instructions along with the warranty card in a safe place.
- **Power is supplied to some of the circuitry even when the power is set to the standby mode using the power operation switch. When traveling or leaving home for long periods of time, be sure to unplug the power supply cord from the power outlet.**
- **Note that the illustrations in these instructions may differ from the actual unit for explanation purposes.**

NOTE:

- This CD player uses a semiconductor laser. To ensure stable operation, it is recommended to use the set indoors at a temperature of 5°C (41°F) ~ 35°C (95°F).

About discs

Discs usable on this set

① Music CDs

Discs with the mark at the right can be used on this set.
Note however that discs with special shapes (heart-shaped discs, octagonal discs, etc.) cannot be played. Do not attempt to play them, as doing so could damage the set.

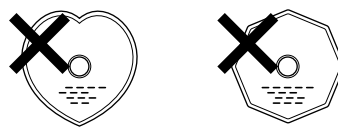

② CD-R/CD-RW

- Some discs and some recording formats may not be playable.
- Non-finalized discs cannot be played.

※ Finalization:

Finalization is the process that makes recorded CD-R/CD-RW discs playable on compatible players.

Holding discs



Do not touch the signal surface.

Getting Started

Loading discs

- Set the disc with the labeled side facing up.
- Make sure the disc tray is fully open when inserting the disc.
- Place the discs flatly, 12 cm discs in the outer tray guide (Figure 1), 8 cm discs in the inner tray guide (Figure 2).

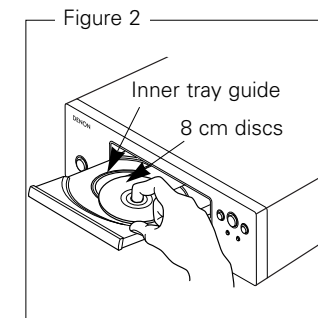
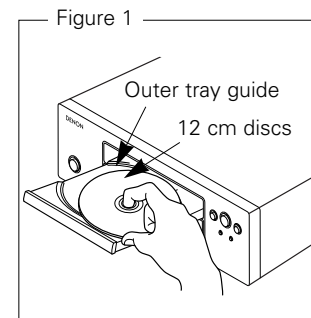

- Place 8 cm discs in the inner tray guide without using an adapter.



- In the following cases, "00 m 00 s" is shown on the display:
 - When no disc is loaded
 - When the disc is loaded upside-down
 - When the disc's information could not be read properly

Getting Started

Cautions on loading discs

- Only load one disc at a time. Loading two or more discs can damage the set or scratch the discs.
- Do not use cracked or warped discs or discs that have been repaired with adhesive, etc.
- Do not use discs on which the sticky part of cellophane tape or labels is exposed or on which there are traces of where labels have been removed. Such discs could get caught inside the player and damage it.

Cautions on handling

- Do not get fingerprints, oil or dirt on discs.
- Take special care not to scratch discs when removing them from their cases.
- Do not bend or heat discs.
- Do not enlarge the hole at the center.
- Do not write on the labeled (printed) surface with ball-point pens, pencils, etc., or stick new labels on discs.
- Water droplets may form on discs if they are moved suddenly from a cold place (outdoors for example) to a warm place, but do not try to dry them off using a hairdryer, etc.

Cautions on storing discs

- Be sure to remove discs after using them.
- Be sure to store discs in their cases to protect them from dust, scratches, warping, etc.
- Do not store discs in the following places:
 1. Places exposed to direct sunlight for long periods of time
 2. Dusty or humid places
 3. Places exposed to heat from heating appliances, etc.

Cleaning discs

- If there are fingerprints or dirt on discs, wipe them off before using the disc. If not the sound quality could be reduced and the sound may be broken.
- Use a commercially available disc cleaning set or a soft cloth to clean discs.

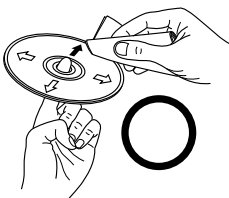

Gently wipe the disc from the inside towards the outside.

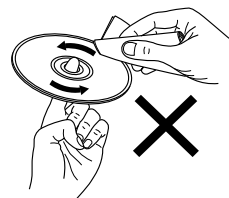

Do not wipe with a circular motion.

NOTE:

- Do not use record spray, antistatic agents, or benzene, thinner or other solvents.

Getting Started

Part names and functions

For buttons not explained here, see the page indicated in parentheses ().

Front panel

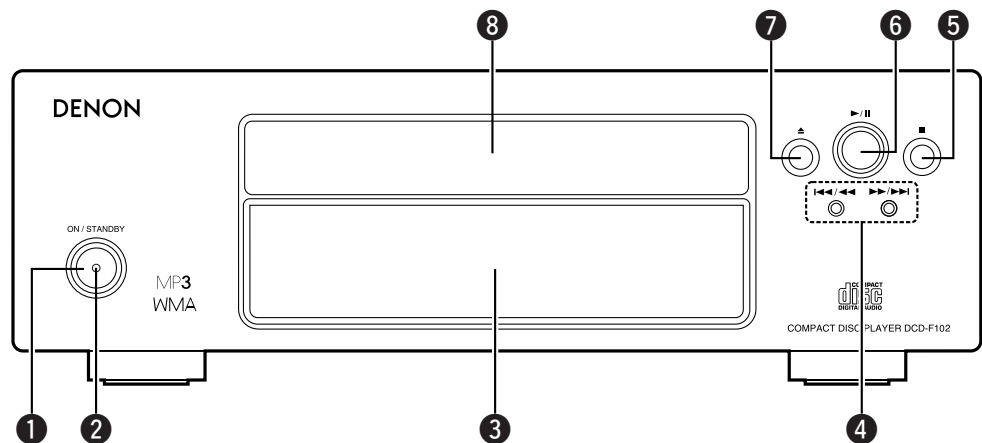

- 1 Power operation switch (ON/STANDBY)(7)
- 2 Power indicator(7)
- 3 Display(4)
- 4 Skip buttons (I◀◀, ▶▶I)(8, 9, 11)
Search buttons (◀◀, ▶▶)(8)
- 5 Stop button (■)(7)
- 6 Play/Pause button (▶/||)(7 ~ 9, 11, 14)
- 7 Disc tray open/close button (▲)(7)
- 8 Disc tray(7)

Getting Started

Display

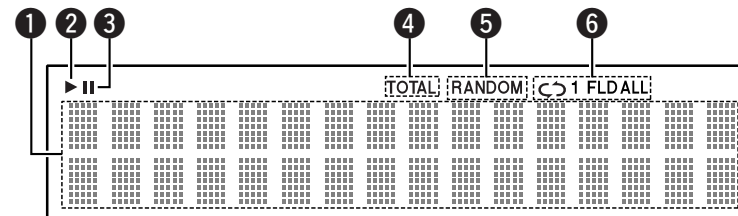

- 1 Information display
Various information is displayed here, depending on the operation mode.
For a music CD:
 - Total number of tracks
 - Total playing time
 - Track number
 - Elapsed time, etc.
 For MP3/WMA files:
 - Total number of folders
 - Number of tracks
 - Folder number
 - Elapsed time
 - Track name
 - Artist name
 - Album name, etc.
- 2 Lights when a disc is playing.
- 3 Lights when the pause mode is set.
- 4 Lights when the total number of tracks and total time are displayed at 1.
- 5 Lights when in the random play mode.
- 6 Lights when in the repeat play mode.
The display switches as follows each time the REPEAT button is pressed.
 - In modes other than the folder mode:

↻ 1
↻ ALL

(1-track repeat)
(All-track repeat)

Not displayed
 - In the folder mode:

↻ 1 FLD
↻ FLD

(1-track repeat)
(All-track repeat between folders)

FLD

Getting Started

Rear panel

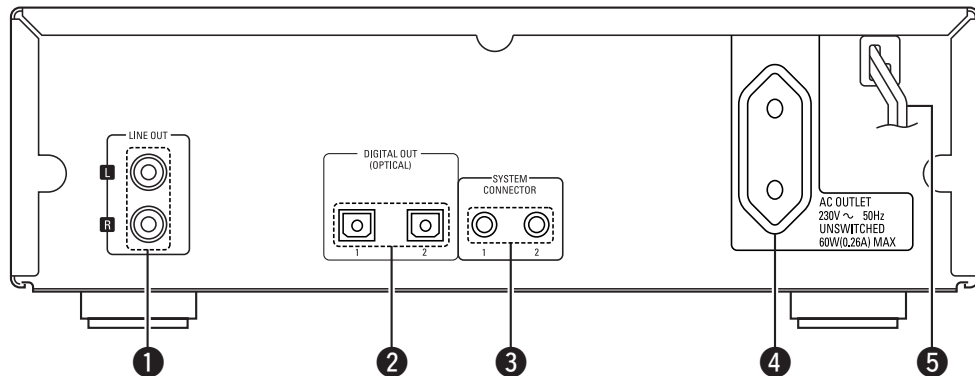

- 1 LINE OUT terminals(6)
- 2 DIGITAL OUT (OPTICAL) terminals(6)
- 3 SYSTEM CONNECTOR jacks(6)
- 4 AC outlet(6)
- 5 Power supply cord(6)

Recommended system layout

To ensure performance and safety, it is recommended to arrange the components as shown below when connecting to models in the F102 series.

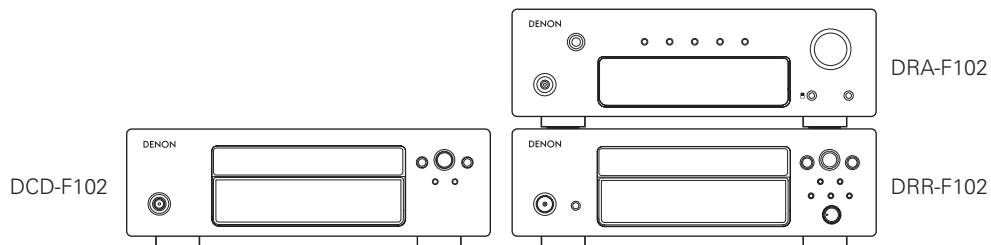

- NOTE:**
- Arrange in such a way that the receiver's ventilation holes are not obstructed so that the heat can dissipate.
 - Do not place other components directly on top of the receiver.
 - To ensure safety, do not make stacks of more than three components.

Connections

- NOTE:**
- Do not plug in the power supply cord until all connections have been completed.
 - When making connections, also refer to the operating instructions of the other components.
 - Be sure to connect the left and right channels properly (left with left, right with right).
 - Do not bundle power supply cords together with speaker cables. Doing so could result in humming or noise.
 - Making connections with the power turned on could result in noise or damage the speakers.
 - Bunching the power supply cords and connection cables together could result in humming or noise.
 - Connect all the connection cables between the different components firmly. The system may not operate properly if the connections are incomplete.
 - Be sure to disconnect the power supply cords when changing the connections. Changing the connections while the system is operating could result in malfunction.

Cable indications

Connect using the connection cables shown below.

Audio cable	Signal direction
<p>A Analog connections (Stereo)</p> <p>(White) (Red)</p> <p>Pin-plug cable</p>	<p>Audio signal</p> <p>IN OUT</p>
<p>B System connections</p> <p>System cable</p>	<p>OUT IN</p>

Connections [System connections]

System operations can be performed when the components of the F102 series are connected with system cables (see page 13).



- All of the system operations are controlled from the receiver (DRA-F102/F102DAB).
- It is also possible to connect devices other than F102 series components. In this case, however, system operations cannot be performed.

When connecting the optical digital output connector with an optical transmission cable (commercially available)

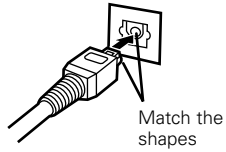

Match the shapes then insert firmly all the way in.

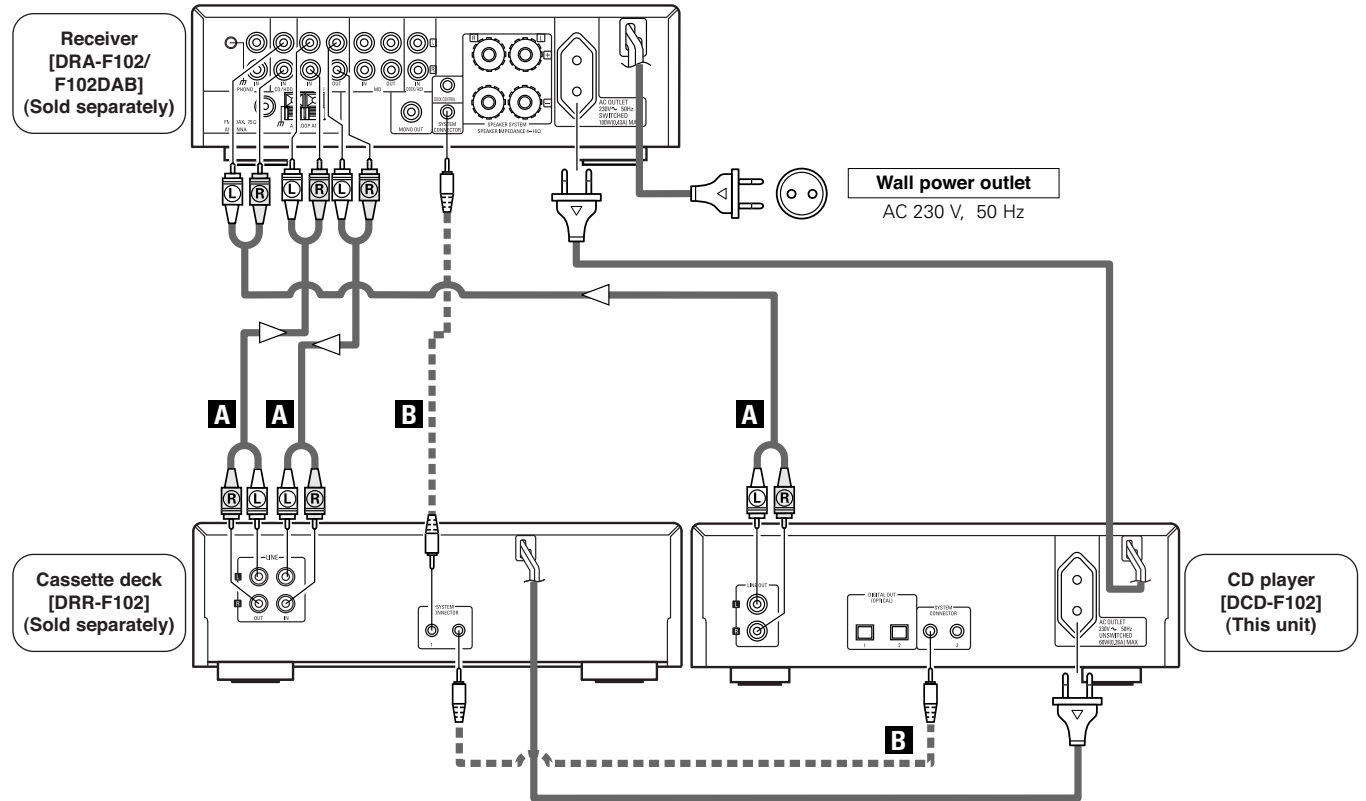

NOTE:

- Do not unplug the power supply cord while the system is operating.
- The maximum total power consumption of devices connected to the DCD-F102's AC outlets is 60 W. Do not connect devices with power consumptions greater than 60 W.

Operation

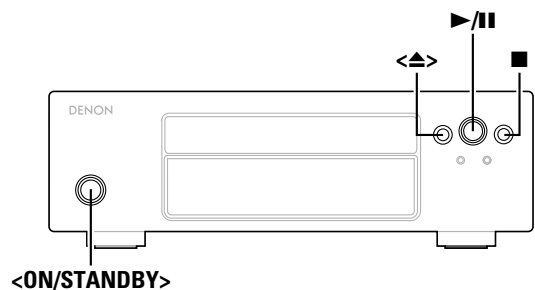

When the DCD-F102 and receiver (DRA-F102/F102DAB) are connected using system connections, the DCD-F102 can be operated using the system remote control (RC-1034) unit included with the receiver.

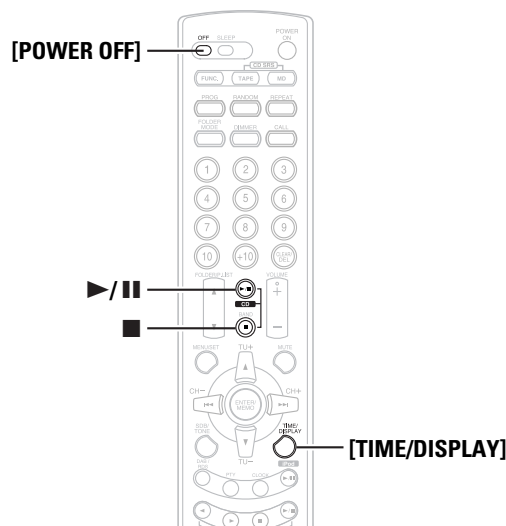

About the button names in this explanation
 < > : Buttons on the main unit
 [] : Buttons on the remote control unit
Button name only :
 Buttons on the main unit and remote control unit

Turning the power on

Press <ON/STANDBY>.
 • When the power turns on, the power indicator lights green.

Turning the power off (to the standby mode):
 Press <ON/STANDBY> again or [POWER OFF].
 The power indicator turns off.

NOTE:
 • To turn off the power while a disc is playing, be sure to press ■ to stop playback before turning off the power.
 • When in the standby mode, a very small amount of power is consumed, even if all the indicators are turned off.

Loading discs

(☞ page 2)

Press <▲> to open the disc tray.

To close the disc tray:
 Press <▲> again.

NOTE:
 • Be sure to turn on the power when opening and closing the disc tray.
 • Do not push the disc tray in by hand when the power is off. Doing so could damage it.
 • Do not insert foreign objects into the disc tray. Doing so will damage it.

Starting playback

Press ▶/II.
 • The “▶” indicator lights and playback starts.
 ※ Once all the tracks recorded on the disc have been played, the stop mode is set automatically.
 ※ [TIME/DISPLAY] can be used to switch the information displayed.

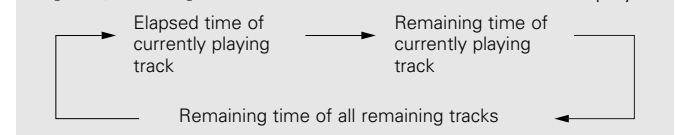

To stop playback

Press ■ during playback.

To pause playback

Press ▶/II during playback.
 • The “II” indicator lights and the pause mode is set.

To resume playback:
 Press ▶/II.

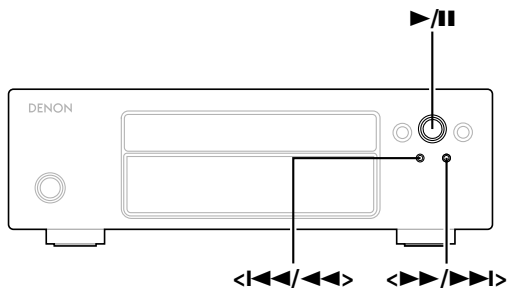

When the DCD-F102 and receiver (DRA-F102/F102DAB) are connected using system connections, the DCD-F102 can be operated using the system remote control (RC-1034) unit included with the receiver.

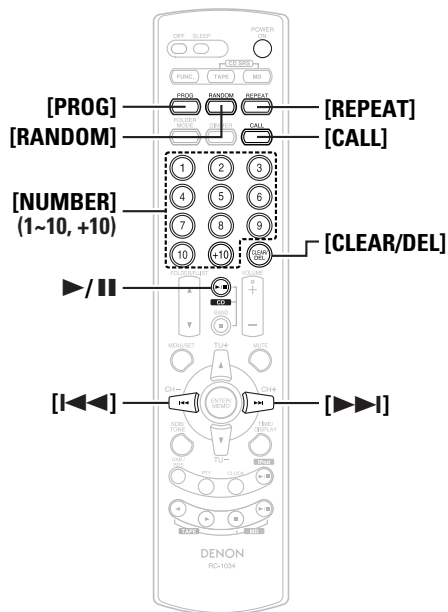

About the button names in this explanation
 < > : Buttons on the main unit
 [] : Buttons on the remote control unit
Button name only :
 Buttons on the main unit and remote control unit

Fast-forwarding (Search)

Press and hold <▶▶▶/▶▶▶> or [▶▶▶I] during playback.

※ Normal playback resumes when you release your finger from the button.

To search forward at high speed:
 In the pause mode, Press and hold <▶▶▶/▶▶▶> or [▶▶▶I].



• The sound may be interrupted shortly when resuming normal playback after searching.

Fast-reversing (Search)

Press and hold <◀◀◀/◀◀◀> or [I◀◀◀] during playback.

※ Normal playback resumes when you release your finger from the button.

To search backward at high speed:
 In the pause mode, Press and hold <◀◀◀/◀◀◀> or [I◀◀◀].



• The sound may be interrupted shortly when resuming normal playback after searching.

Moving to the beginning of tracks (Skip)

Press [I◀◀◀] or [▶▶▶I] during playback.

※ The operation is as follows if the button is held in:
 ▶▶▶I: Skip to the beginning of tracks several tracks on
 I◀◀◀: Skip to the beginning of tracks several tracks before

Playing the desired track (Direct play)

Use [NUMBER] (1 ~ 10, +10) to select the track.

※ For track numbers 1 to 10, press the corresponding button ([1] to [10]).
 For track numbers 11 and on, first press [+10] then press buttons [1] to [10].

Example: Track 4 : [4]
Example: Track 12 : [+10] [2]
Example: Track 20 : [+10] [10]

Listening to specific tracks in a specific order (Programmed play)

Up to 25 tracks can be programmed.

1 In the stop mode, press [PROG].
 • "PGM" is displayed.

2 Use [NUMBER] (1 ~ 10, +10) to select the track.
Example: To program tracks 3, 12, 7 to play in that order:
 [3] [+10] [2] [7]

3 Press ▶/II.
 • The tracks are played in the programmed order.

Checking the programmed tracks:
 In the stop mode, press [CALL].

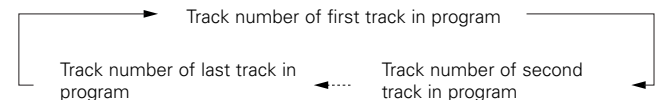

※ The total program time reappears if [CALL] is not operated for 5 seconds or more.

Operation

 To change a programmed track:

In the stop mode, use [PROG] to turn off the programmed track number display, then perform steps **1** and **2** over.

 Clearing tracks from the program:

In the stop mode, press [CLEAR/DEL].

The last track in the program is deleted each time the button is pressed.

 Stopping programmed playback:

In the stop mode, use [PROG] to turn off the programmed track number display.



- During programmed playback, press [REPEAT] to play the programmed tracks repeatedly.

NOTE:

- If the disc tray is opened after performing the program search operation, the program is cleared.

Listening in random order (Random playback)**1** In the stop mode, press [RANDOM].

- The "RANDOM" indicator lights.

2 Press ►/II. Stopping random playback:

Press [RANDOM].

The "RANDOM" indicator turns off.



- If [REPEAT] is pressed during random playback, the tracks are played once in one random pattern, then played again in a different order. Enjoy listening to them in a different order each time.

Listening to tracks repeatedly (Repeat play)**Listening to a specific track repeatedly (1-track repeat play)****1** Press [REPEAT] once in the stop or play mode.

- The "↻ 1" indicator lights.

**2** Use <|◀◀/◀◀> or <▶▶/▶▶> ([|◀◀] or [▶▶|]) to select the track you want to hear.**3** Press ►/II.

- The selected track is played repeatedly.

 Stopping 1-track repeat playback:

Press [REPEAT] until the "↻ 1" indicator turns off.

Listening to all the tracks repeatedly (All-track repeat play)**1** Press [REPEAT] twice in a row in the stop or play mode.

- The "↻ ALL" indicator lights.

2 Press ►/II.

- The currently playing disc is played repeatedly.

 Stopping all-track repeat playback:

Press [REPEAT] until the "↻ ALL" indicator turns off.

Cuing and stopping playback (Pause)

Setting the pause mode after cuing to the beginning of the selected track is convenient when recording onto cassette tapes.

Cuing with direct searching**1** Press ►/II once in the play mode.

- The "II" indicator lights.

※ In the stop mode, press ►/II twice in a row.

2 Use [NUMBER] (1 ~ 10, +10) to select the track. To start playback:

Press ►/II.



- During programmed playback, use <|◀◀/◀◀> or <▶▶/▶▶> ([|◀◀] or [▶▶|]) to select the track.

Cuing with programmed searching**1** In the stop mode, press [PROG].

- "PGM" is displayed.

2 Use [NUMBER] (1 ~ 10, +10) to select the track.**3** Press ►/II twice.

- The beginning of the first programmed track is found and the pause mode is set.

 To start playback:

Press ►/II.

Playing MP3 or WMA (Windows Media® Audio) files

Before playing MP3 or WMA files

There are many music distribution sites on the Internet allowing you to download music files in MP3 or WMA format. The music (files) downloaded from such sites can be stored on CD-R or CD-RW discs and played on the DCD-F102.



“Windows Media” and “Windows” are registered trademarks or trademarks in the United States and other countries of the Microsoft Corporation of the United States.

※ **According to copyright laws, recordings you have made should only be used for your personal enjoyment and must not be used in other ways without the consent of the copyright holder.**

Order in which the folders are played

If there are multiple folders containing MP3 or WMA files, the DCD-F102 automatically assigns the folders numbers when reading the disc. The folders switch according to the numbers they have been assigned. If there are no playable files in a folder, that folder is ignored.

Order in which files are played

The order in which the files are played depends on the folder structure attributed when the disc was created and other data recorded on the disc when the files were recorded. With the folder structure shown in the following example, the files are played in numerical order (1, 2, 3 ...).

※ The data stored on the disc depends on the writing software. Because of this, the files may not play in the desired order.

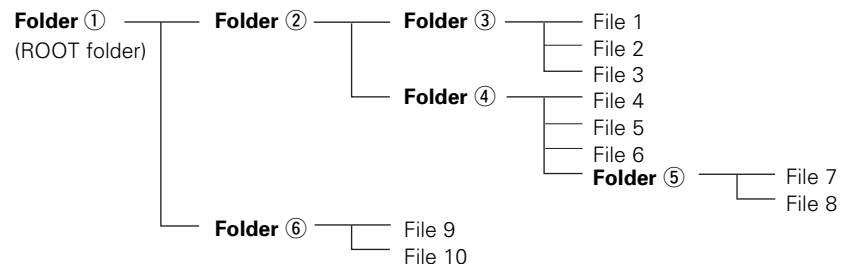

Setting the folders and files to be played (folder mode/file mode)

Use **[FOLDER MODE]** to switch between the modes.

• Folder mode

The “FLD” indicator lights.

Only the selected folder is played.

Example: When folder ④ is selected

Files 4, 5 and 6 are played.

Folder ⑤ is treated as a separate folder, so files 7 and 8 are not played.

• Disc mode (folder mode: OFF)

The “FLD” indicator turns off.

All the files in all the folders from the selected folder or file on are played.

Example: When file 3 in folder ③ is selected

All the files from file 3 on are played.

Operation

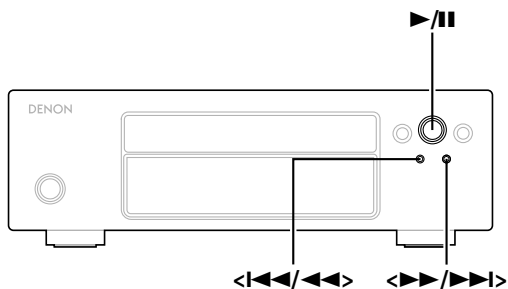

When the DCD-F102 and receiver (DRA-F102/F102DAB) are connected using system connections, the DCD-F102 can be operated using the system remote control (RC-1034) unit included with the receiver.

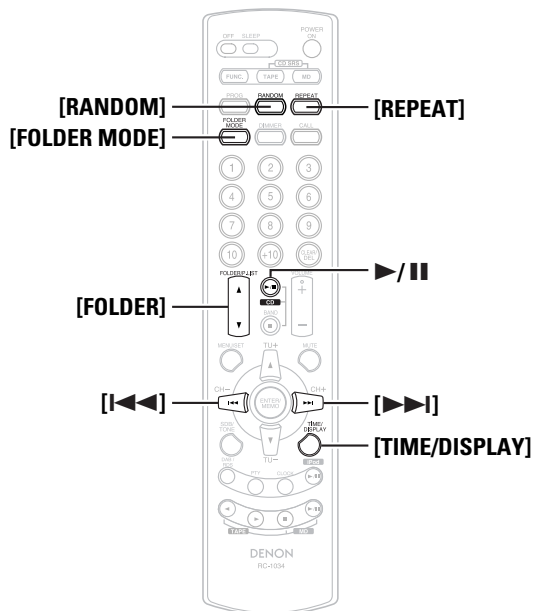

About the button names in this explanation
 < > : Buttons on the main unit
 [] : Buttons on the remote control unit
Button name only :
 Buttons on the main unit and remote control unit

Operation

Playing MP3 or WMA files

1 Load a CD-R or CD-RW disc containing music files in MP3 or WMA (Windows Media Audio) format into the disc tray (☞ page 2, 7).

2 When in the folder mode:
-1 Use [FOLDER MODE] to turn on the “FLD” indicator, then use [FOLDER] to select the folder to be played.
 • The selected folder is displayed.

2 About the disc mode:
-2 Use [FOLDER MODE] to turn off the “FLD” indicator, then use ◀◀◀/◀◀▶ or ▶▶▶/▶▶▶ (◀◀◀ or ▶▶▶) to select the file to be played.
 • The selected file is displayed.

3 Press ▶/||.
 • The file name, title/artist name and title/album name scroll on the display and playback starts.

- ※ The title name, artist name and album name are only displayed if that information is recorded on the disc.
- ※ [TIME/DISPLAY] can be used to switch the information displayed.



To change the folder to be played:
 Use [FOLDER] to select a different folder.

To change the file to be played:
 In the stop mode, use ◀◀◀/◀◀▶ or ▶▶▶/▶▶▶ (◀◀◀ or ▶▶▶) to select a different file.

- If the folder is selected in the play or pause mode, playback starts from or the pause mode is set at the first track in the selected folder.
- If a copyright-protected WMA file or a file that cannot be played normally is selected, “Not Support” is displayed. Use ◀◀◀/◀◀▶ or ▶▶▶/▶▶▶ (◀◀◀ or ▶▶▶) to select a different file.

Listening to MP3 or WMA files in random order (Random folder/disc play)

1 Perform steps 2-1 or 2-2 under “Playing MP3 or WMA files”.

2 Press [RANDOM].
 • The “RANDOM” indicator lights.

3 Press ▶/||.
 • Either the files in the selected folder or all the files on the disc are played in random order.

To stop random folder/disc playback:
 Press [RANDOM].
 The “RANDOM” indicator turns off.

- If [REPEAT] is pressed during random playback, the tracks are played once in one random pattern, then played again in a different order. Enjoy listening to them in a different order each time.

Operation

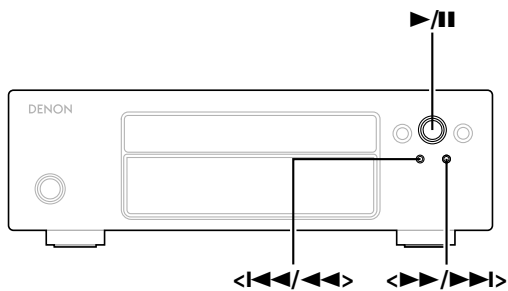

When the DCD-F102 and receiver (DRA-F102/F102DAB) are connected using system connections, the DCD-F102 can be operated using the system remote control (RC-1034) unit included with the receiver.

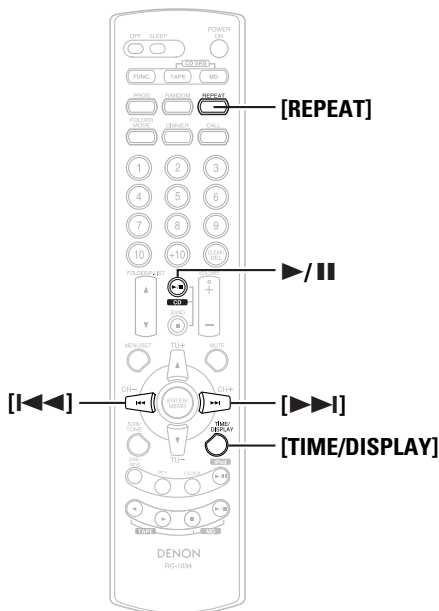

About the button names in this explanation
 < > : Buttons on the main unit
 [] : Buttons on the remote control unit
Button name only :
 Buttons on the main unit and remote control unit

Operation

Listening to MP3 or WMA files repeatedly (Repeat folder/disc play)

1 Perform steps **2-1** or **2-2** under “Playing MP3 or WMA files” (page 11).

2 Use **[REPEAT]** to select the repeat mode.

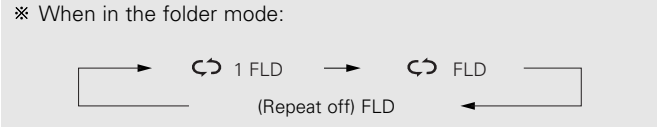

3 Press **[PLAY/PAUSE]**.
 • Either the files in the selected folder or all the files on the disc are played repeatedly.

To stop repeat folder/disc playback:
 Press **[REPEAT]** until the “↻” indicator turns off.

NOTE:

- The DCD-F102 is compatible with “MPEG-1 Audio Layer-3” standards (sampling frequency of 44.1 and 48 kHz). It is not compatible with “MPEG-2 Audio Layer-3”, “MPEG-2.5 Audio Layer-3”, MP1 or MP2 standards.
- Programmed playback is not possible with discs containing files recorded in MP3 or WMA format.
- The signals are output with a sampling frequency of 44.1 kHz.
- When writing MP3 files on a CD-R or CD-RW disc, set the writing software’s format to “ISO9660 Level 1”. The files may not play properly if they are recorded in other formats. Also note that with some writing software it is not possible to record in ISO9660 format. If so, use a different program allowing you to record in ISO9660 format.
- With MP3 files, the higher the bit rate, the better the sound quality. The compatible bit rate range is 32 to 320 kbps for MP3 files, 64 to 160 kbps for WMA files. We recommend using MP3 files with bit rates of 128 kbps or greater on the DCD-F102.
- Be sure to add the extensions “.MP3” or “.WMA” to MP3 or WMA files, respectively. Files with extensions other than “.MP3” or “.WMA” or files without extensions cannot be played. (On Macintosh computers, MP3 files can be played by giving the extension “.MP3” after the file name consisting up a maximum of 8 alphanumeric characters and storing the files on a CD-R or CD-RW disc.)
- The DCD-F102 is not compatible with packet write software or playlists.
- Up to 32 characters of folder and file names can be displayed.
- The DCD-F102 is compatible with MP3 ID3-Tag versions 1.x and 2.x.
- The time may not be displayed properly when searching or pausing during variable bit rate playback.
- The time display cannot be switched using **[TIME/DISPLAY]**.
- For files in which the title name and artist name data are stored, the title name or artist name can be displayed in the play or pause mode by pressing **[TIME/DISPLAY]**.
- Multisession and CD-R/CD-RW discs that have not been completely written can be played, but we recommend using discs closed after a maximum of 10 sessions or discs that have been completed.
- The DCD-F102 is compatible with the titles, artists and albums of WMA file meta tags.
- The maximum number of files and folders playable is 512 (total of the number of folders and files). The maximum number of folders is 256.
- Copyright-protected WMA files cannot be played. (“Not Support” is displayed. Use <[SKIP PREVIOUS] or <[SKIP PREVIOUS] ([SKIP PREVIOUS] or [SKIP NEXT]) to select a different file.)

System Operations

When this set is used with other components in the F102 series, it is possible to perform such system operations as synchronized recording of CDs and to operate all the components with the system remote control unit (included with the receiver (DRA-F102/F102DAB)).



- All of the system operations are controlled from the receiver (DRA-F102/F102DAB).
- Also read the operating instructions of the various components.

System remote control unit

- Operate the set using the system remote control unit (RC-1034) included with the receiver (DRA-F102/F102DAB).
- Point the remote control unit at the remote control sensor on the receiver (DRA-F102/F102DAB) when operating it.
- The buttons shown below are used when operating this set. For a detailed description of their functions and operations, see the page indicated in () or operating instructions of the receiver (DRA-F102/F102DAB).

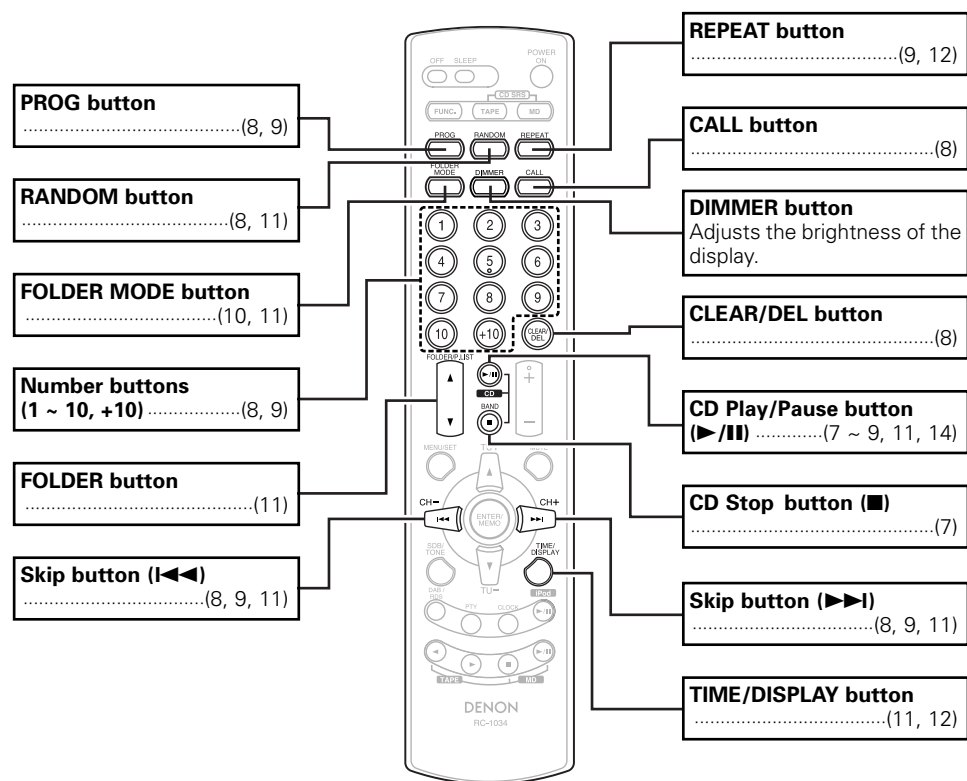

※ No buttons other than the ones described above will operate.

System Operations

Receiver [DRA-F102/F102DAB]

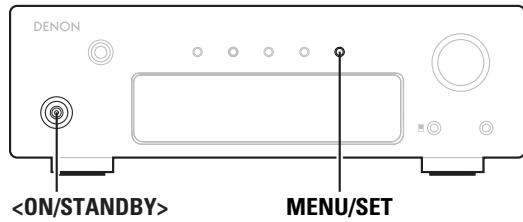

This unit [DCD-F102]

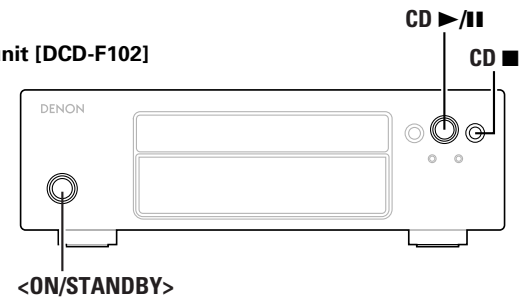

Cassette deck [DRR-F102]

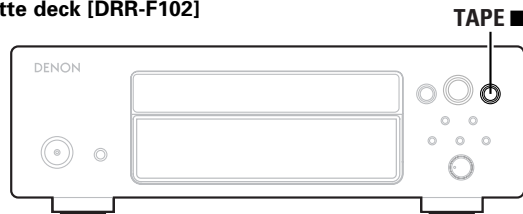

When the DCD-F102 and receiver (DRA-F102/F102DAB) are connected using system connections, the DCD-F102 can be operated using the system remote control (RC-1034) unit included with the receiver.

System remote control unit [RC-1034]

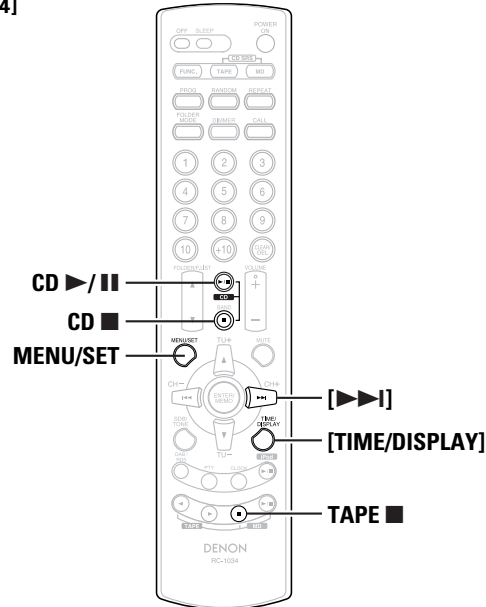

About the button names in this explanation
 < > : Buttons on the main unit
 [] : Buttons on the remote control unit
Button name only :
 Buttons on the main unit and remote control unit



- All of the system operations are controlled from the receiver (DRA-F102/F102DAB).
- It is also possible to connect devices other than F102 series components. In this case, however, system operations cannot be performed.

System Operations

Auto power on function

Press [CD >/II] when the power of the various components is set to the standby mode.

- The power of the various components turns on and the receiver's function automatically switches to "CD".
- When a disc is loaded in the DCD-F102, the disc starts playing.

※ The auto power on function does not work even when <CD >/II> is pressed.

Auto function selection

Press CD >/II during playback on one of the other components.

- Playback stops.
- The receiver's function automatically switches to "CD" and playback of the disc starts.

CD synchronized recording

This function lets you easily record the tracks from a CD onto a cassette tape.
 For instructions, see the cassette deck's operating instructions.

Timer function

The receiver's timer function can be used to perform playback at specific times.
 For instructions, see the receiver's operating instructions.

Edit function

- This function lets you record onto cassette tapes with automatic editing according to the length of the tape.
- Load the CD and cassette tape before starting.

1 Turn on the power of the various components.**2 Press MENU/SET three times in a row.**

- "EDIT" is displayed on the receiver's display.

3 Use [▶▶▶] to set the length of the cassette tape.

Example: To record onto a 60-minute cassette tape, use [▶▶▶] to select "C-60".

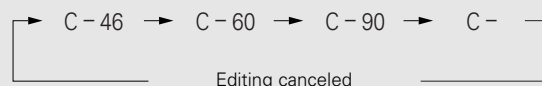

(The length of the cassette tape is the total length for sides A and B.)

- When the length of the cassette tape is set, the display alternates between the track numbers to be recorded and the remaining time for side A and the track numbers to be recorded and the remaining time for side B.

Track number Remaining time

4 Press CD ▶/II.

- Recording of the CD starts.

 Setting a specific cassette tape length:

When "C -" is displayed, use [NUMBER] (1 ~ 10, +10) to input the time.

Example: To set to 54 minutes

[+10] [+10] [+10] [+10] [+10] [4]

※ The length can be set to up to 99 minutes.

 Canceling the editing function:

Press CD ■ or <TAPE ■>.

NOTE:

- The editing function does not work with discs containing 26 tracks or more.
- When using the edited recording function, be sure to load the cassette tape with side A facing upwards. The beginning of the cassette tape is found automatically before recording starts.
- When using a tape that is already recorded on, erase the tape before conducting edited recording.
- When using the edited recording function, set the cassette deck's reverse mode to "↶".
- In some cases it may not be possible to record all the tracks on the cassette tape even if its length is longer than the total length of the tracks on the disc, due to the fact that the tracks must be divided between sides A and B. "OVER" is displayed on the DCD-F102's display if there are tracks that cannot be recorded. If "OVER" is displayed, change the length of the cassette tape as described in step **3**.
- When the editing function is in use, no buttons other than <ON/STANDBY>, MENU/SET, [▶▶▶], CD ▶/II, CD ■, <TAPE ■> and [TIME/DISPLAY] will operate.
- With edited recording, blank sections approximately 4 seconds long are automatically created between tracks. If you do not want these blank sections, do not use edited recording.
- Edited recording is not possible with discs containing files in MP3 or WMA format.

Others

Troubleshooting

If a problem should arise, first check the following:

1. Are the connections correct ?

2. Have you operated the player according to the Operating Instructions ?

If this unit is not operating properly, check the items listed in the table below. Should the problem persist, there may be a malfunction. Disconnect the power immediately and contact your store of purchase.

Symptom	Cause	Measures	Page
Display does not light and no sound is produced when power is turned on.	<ul style="list-style-type: none"> Power supply cord is not plugged into power outlet. 	<ul style="list-style-type: none"> Plug the power supply cord into the power outlet. 	6
"00 m 00 s" is shown on the display even though a CD is loaded.	<ul style="list-style-type: none"> The disc is not properly loaded. 	<ul style="list-style-type: none"> Reload the disc. 	2
Disc is not played when ►/ button is pressed.	<ul style="list-style-type: none"> The disc is dirty or scratched. 	<ul style="list-style-type: none"> Wipe the dirt off the disc or replace the disc. 	3
No sound is produced or sound is distorted.	<ul style="list-style-type: none"> Incomplete connections with the various devices. The receiver's function setting or adjustments are not right. 	<ul style="list-style-type: none"> Check the connections. Check the receiver's function and controls and adjust as necessary. 	6 -
Specific section of the disc cannot be played properly.	<ul style="list-style-type: none"> The disc is dirty or scratched. 	<ul style="list-style-type: none"> Wipe the dirt off the disc or replace the disc. 	3
Programmed playback is not possible.	<ul style="list-style-type: none"> The tracks have not been programmed properly. You are playing a disc containing files in MP3 or WMA format. 	<ul style="list-style-type: none"> Program properly. Programmed playback is not possible with containing files in MP3 or WMA format. 	8 -
A CD-R or CD-RW disc cannot be played.	<ul style="list-style-type: none"> The disc has not been finalized. The recording conditions are bad or the quality of the disc itself is poor. 	<ul style="list-style-type: none"> Finalize the disc then play it. Use a properly recorded disc. 	2 -
"Not Support" is displayed when playing files recorded in MP3 or WMA format.	<ul style="list-style-type: none"> You have selected a copyright-protected WMA file or a file that cannot be played normally. 	<ul style="list-style-type: none"> Use the ◀◀/◀ or ▶▶/▶▶ button on the main unit (the ◀◀ or ▶▶ button on the remote control unit) to select a different file. 	11, 12

Specifications

Audio performance

No. channels:	2 channels
Frequency response:	2 Hz ~ 20 kHz
Dynamic range:	100 dB
S/N:	105 dB
Harmonic distortion:	0.005 % (1 kHz)
Separation:	95 dB
Wow & flutter:	Below measurable limits (± 0.001 % W. peak)
Analog audio output:	Output level : 2.0 Vrms (LINE OUT)

Usable discs:

Compact Disc

Diameter: 120 mm/80mm

Signal format

Sampling frequency:	44.1 kHz
Quantization bit:	16-bit linear/channel
Transfer bit rate:	4.3218 Mb/seconds

Digital output signal format

Format:	Digital audio interface
Optical output:	-15 ~ -21 dBm
Emission wavelength:	660 nm

Pickup

Type:	Objective lens drive type pickup
Objective lens drive type:	Secondary parallel drive
Light source:	Semiconductor laser
Wavelength:	780 nm

General

Power supply:	AC 230 V, 50 Hz
Power consumption:	15 W
	Standby : 0.1 W or less
Maximum external dimensions:	250 (W) x 78 (H) x 250 (D) mm (Not including protruding parts)
	250 (W) x 82 (H) x 260 (D) mm (Including protruding parts)
Mass:	2.9 kg

* For purposes of improvement, specifications and design are subject to change without notice.

DENON

TOKYO, JAPAN
www.denon.com

Denon Brand Company, D&M Holdings Inc.
Printed in China 00D 511 4463 004