

DENON

DOUBLE CD PLAYER

雙碟雷射唱盤

DN-2100F

OPERATING INSTRUCTIONS

BEDIENUNGSANLEITUNG

MODE D'EMPLOI

INSTRUCCIONES DE OPERACION

GEBRUIKSAANWIJZING

BRUKSANVISNING

操作說明書

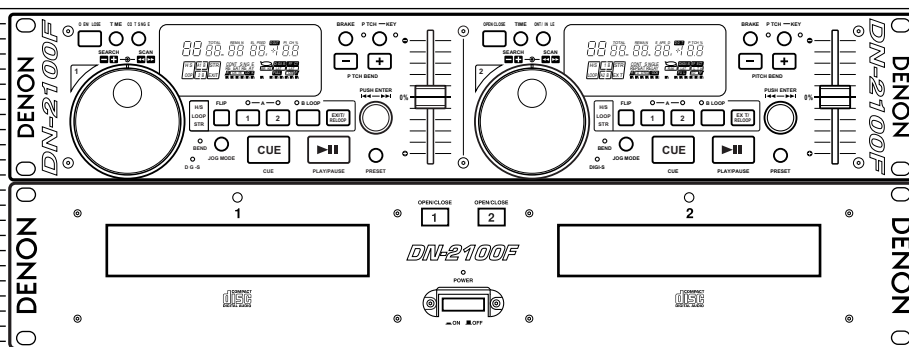

FOR ENGLISH READERS

FÜR DEUTSCHE LESER

POUR LES LECTEURS FRANCAIS

PARA LECTORES DE ESPAÑOL

VOOR NEDERLANDSTALIGE LEZERS

FÖR SVENSKA LÄSARE

中文

PAGE 7 ~ PAGE 20

SEITE 21 ~ SEITE 34

PAGE 35 ~ PAGE 48

PAGINA 49 ~ PAGINA 62

PAGINA 63 ~ PAGINA 76

SIDA 77 ~ PAGINA 90

第 91 頁 ~ 第 104 頁

IMPORTANT TO SAFETY

WARNING:

TO PREVENT FIRE OR SHOCK HAZARD, DO NOT EXPOSE THIS APPLIANCE TO RAIN OR MOISTURE.

CAUTION:

1. Handle the power supply cord carefully

Do not damage or deform the power supply cord. If it is damaged or deformed, it may cause electric shock or malfunction when used. When removing from wall outlet, be sure to remove by holding the plug attachment and not by pulling the cord.

2. Do not open the top cover

In order to prevent electric shock, do not open the top cover. If problems occur, contact your DENON dealer.

3. Do not place anything inside

Do not place metal objects or spill liquid inside the CD player. Electric shock or malfunction may result.

Please, record and retain the Model name and serial number of your set shown on the rating label.

Model No. DN-2100F

Serial No. _____



CAUTION
RISK OF ELECTRIC SHOCK
DO NOT OPEN



CAUTION: TO REDUCE THE RISK OF ELECTRIC SHOCK, DO NOT REMOVE COVER (OR BACK). NO USER-SERVICEABLE PARTS INSIDE. REFER SERVICING TO QUALIFIED SERVICE PERSONNEL.

The lightning flash with arrowhead symbol, within an equilateral triangle, is intended to alert the user to the presence of uninsulated "dangerous voltage" within the product's enclosure that may be of sufficient magnitude to constitute a risk of electric shock to persons.

The exclamation point within an equilateral triangle is intended to alert the user to the presence of important operating and maintenance (servicing) instructions in the literature accompanying the appliance.

NOTE:

This CD player uses the semiconductor laser. To allow you to enjoy music at a stable operation, it is recommended to use this in a room of 5 °C (41 °F) –35 °C (95 °F).

• FOR CANADA MODEL ONLY

CAUTION

TO PREVENT ELECTRIC SHOCK, MATCH WIDE BLADE OF PLUG TO WIDE SLOT, FULLY INSERT.

LABELS (for U.S.A. model only)

CERTIFICATION

THIS PRODUCT COMPLIES WITH DHHS RULES 21 CFR SUBCHAPTER J APPLICABLE AT DATE OF MANUFACTURE.

CAUTION:

USE OF CONTROLS OR ADJUSTMENTS OR PERFORMANCE OF PROCEDURES OTHER THAN THOSE SPECIFIED HEREIN MAY RESULT IN HAZARDOUS RADIATION EXPOSURE.

THE COMPACT DISC PLAYER SHOULD NOT BE ADJUSTED OR REPAIRED BY ANYONE EXCEPT PROPERLY QUALIFIED SERVICE PERSONNEL.

This device complies with Part 15 of the FCC Rules. Operation is subject to the following two conditions : (1) This device may not cause harmful interference, and (2) this device must accept any interference received, including interference that may cause undesired operation.

This Class B digital apparatus meets all requirements of the Canadian Interference-Causing Equipment Regulations.

Cet appareil numérique de la classe B respecte toutes les exigences du Règlement sur le matériel brouilleur du Canada.

CLASS 1 LASER PRODUCT
LUOKAN 1 LASERLAITE
KLASS 1 LASERAPPARAT

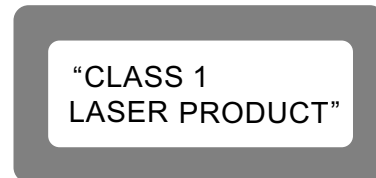

ADVARSEL: OSYNLIG LASERSTRÅLING VED ÅBNING, NÅR SIKKERHEDSAFBRYDERE ER UDE AF FUNKTION. UNDGÅ UDSAETTELSE FOR STRÅLING.

VAROITUS! LAITTEEN KÄYTTÄMINEN MUULLA KUIN TÄSSÄ KÄYTTÖOHJEESSA MAINITULLA TAVALLA SAATTAA ALTISTAA KÄYTTÄJÄN TURVALLISUUSLUOKAN 1 YLITTÄVÄLLE NÄKYMÄMTTÖMÄLLE LASERSÄTEILYLLE.

VARNING— OM APPARATEN ANVÄNDS PÅ ANNAT SÄTT ÄN I DENNA BRUKSANVISNING SPECIFICERATS, KAN ANVÄNDAREN UTSÄTTAS FÖR OSYNLIG LASERSTRÅLNING SOM ÖVERSKRIDER GRÄNSEN FÖR LASERKLASS 1.

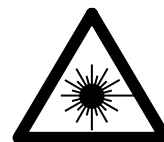

• POUR LES MODELE CANADIENS UNIQUEMENT

ATTENTION

POUR ÉVITER LES CHOCs ÉLECTRIQUES, INTRODUIRE LA LAME LA PLUS LARGE DE LA FICHE DANS LA BORNE CORRESPONDANTE DE LA PRISE ET POUSSER JUSQU' AU FOND.

SAFETY INSTRUCTIONS

1. Read Instructions – All the safety and operating instructions should be read before the appliance is operated.
2. Retain Instructions – The safety and operating instructions should be retained for future reference.
3. Heed Warning – All warnings on the appliance and in the operating instructions should be adhered to.
4. Following Instructions – All operating and use instructions should be followed.
5. Water and Moisture – The appliance should not be used near water – for example, near a bathtub, washbowl, kitchen sink, laundry tub, in a wet basement, or near a swimming pool, and the like.
6. Carts and Stands – The appliance should be used only with a cart or stand that is recommended by the manufacturer.
- 6A. An appliance and cart combination should be moved with care. Quick stops, excessive force, and uneven surfaces may cause the appliance and cart combination to overturn.
7. Wall or Ceiling Mounting – The appliance should be mounted to a wall or ceiling only as recommended by the manufacturer.
8. Ventilation – The appliance should be situated so that its location or position does not interfere with its proper ventilation. For example, the appliance should not be situated on a bed, sofa, rug, or similar surface that may block the ventilation openings; or, placed in a built-in installation, such as a bookcase or cabinet that may impede the flow of air through the ventilation openings.
9. Heat – The appliance should be situated away from heat sources such as radiators, heat registers, stoves, or other appliances (including amplifiers) that produce heat.
10. Power Sources – The appliance should be connected to a power supply only of the type described in the operating instructions or as marked on the appliance.
11. Grounding or Polarization – Precautions should be taken so that the grounding or polarization means of an appliance is not defeated.
12. Power-Cord Protection – Power-supply cords should be routed so that they are not likely to be walked on or pinched by items placed upon or against them, paying particular attention to cords at plugs, convenience receptacles, and the point where they exit from the appliance.
14. Cleaning – The appliance should be cleaned only as recommended by the manufacturer.
15. Power Lines – An outdoor antenna should be located away from power lines.
16. Outdoor Antenna Grounding – If an outside antenna is connected to the receiver, be sure the antenna system is grounded so as to provide some protection against voltage surges and built-up static charges. Article 810 of the National Electrical Code, ANSI/NFPA 70, provides information with regard to proper grounding of the mast and supporting structure, grounding of the lead-in wire to an antenna-discharge unit, size of grounding conductors, location of antenna-discharge unit, connection to grounding electrodes, and requirements for the grounding electrode. See Figure A.
17. Nonuse Periods – The power cord of the appliance should be unplugged from the outlet when left unused for a long period of time.
18. Object and Liquid Entry – Care should be taken so that objects do not fall and liquids are not spilled into the enclosure through openings.
19. Damage Requiring Service – The appliance should be serviced by qualified service personnel when:
 - A. The power-supply cord or the plug has been damaged; or
 - B. Objects have fallen, or liquid has been spilled into the appliance; or
 - C. The appliance has been exposed to rain; or
 - D. The appliance does not appear to operate normally or exhibits a marked change in performance; or
 - E. The appliance has been dropped, or the enclosure damaged.
20. Servicing – The user should not attempt to service the appliance beyond that described in the operating instructions. All other servicing should be referred to qualified service personnel.

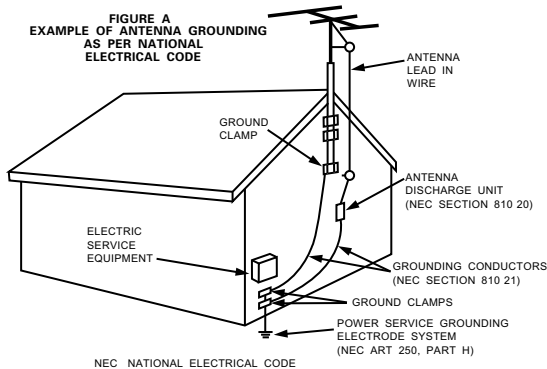

**NOTE ON USE / HINWEISE ZUM GEBRAUCH / OBSERVATIONS RELATIVES A L'UTILISATION
NOTAS SOBRE EL USO / ALVORENS TE GEBRUIKEN / OBSERVERA**

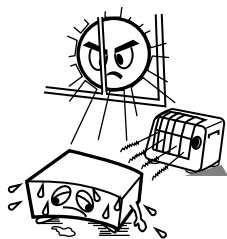

- Avoid high temperatures. Allow for sufficient heat dispersion when installed on a rack.
- Vermeiden Sie hohe Temperaturen. Beachten Sie, daß eine ausreichend Luftzirkulation gewährleistet wird, wenn das Gerät auf ein Regal gestellt wird.
- Eviter des températures élevées. Tenir compte d'une dispersion de chaleur suffisante lors de l'installation sur une étagère.
- Evite altas temperaturas. Permite la suficiente dispersión del calor cuando está instalado en la consola.
- Vermijd hoge temperaturen. Zorg voor een degelijk hitteafvoer indien het apparaat op een rek wordt geplaatst.
- Undvik höga temperaturer. Se till att det finns möjlighet till god värmeavledning vid montering i ett rack.

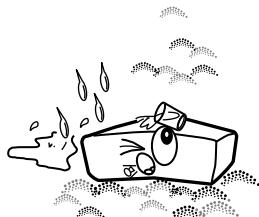

- Keep the set free from moisture, water, and dust.
- Halten Sie das Gerät von Feuchtigkeit, Wasser und Staub fern.
- Protéger l'appareil contre l'humidité, l'eau et lapoussière.
- Mantenga el equipo libre de humedad, agua y polvo.
- Laat geen vochtigheid, water of stof in het apparaat binnendringen.
- Utsätt inte apparaten för fukt, vatten och damm.

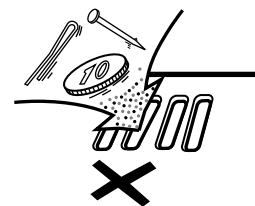

- Do not let foreign objects in the set.
- Keine fremden Gegenstände in das Gerät kommen lassen.
- Ne pas laisser des objets étrangers dans l'appareil.
- No deje objetos extraños dentro del equipo.
- Laat geen vreemde voorwerpen in dit apparaat vallen.
- Se till att främmande föremål inte tränger in i apparaten.

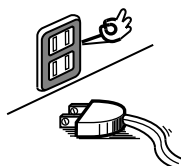

- Unplug the power cord when not using the set for long periods of time.
- Wenn das Gerät eine längere Zeit nicht verwendet werden soll, trennen Sie das Netzkabel vom Netzstecker.
- Débrancher le cordon d'alimentation lorsque l'appareil n'est pas utilisé pendant de longues périodes.
- Desconecte el cordón de energía cuando no utilice el equipo por mucho tiempo.
- Neem altijd het netsnoer uit het stopkontakt wanneer het apparaat gedurende een lange periode niet wordt gebruikt.
- Koppla ur nätkabeln om apparaten inte kommer att användas i lång tid.



- Do not let insecticides, benzene, and thinner come in contact with the set.
- Lassen Sie das Gerät nicht mit Insektiziden, Benzin oder Verdünnungsmitteln in Berührung kommen.
- Ne pas mettre en contact des insecticides, du benzène et un diluant avec l'appareil.
- No permita el contacto de insecticidas, gasolina y diluyentes con el equipo.
- Laat geen insectenverdelgende middelen, benzine of verfverdunder met dit apparaat in kontakt komen.
- Se till att inte insektsmedel på spraybruk, bensen och thinner kommer i kontakt med apparatens hölje.

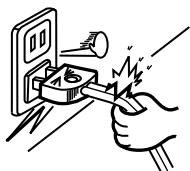

- Handle the power cord carefully. Hold the plug when unplugging the cord.
- Gehen Sie vorsichtig mit dem Netzkabel um. Halten Sie das Kabel am Stecker, wenn Sie den Stecker herausziehen.
- Manipuler le cordon d'alimentation avec précaution. Tenir la prise lors du débranchement du cordon.
- Maneje el cordón de energía con cuidado. Sostenga el enchufe cuando desconecte el cordón de energía.
- Hanteer het netsnoer voorzichtig. Houd het snoer bij de stekker vast wanneer deze moet worden aan- of losgekoppeld.
- Hantera nätkabeln varsamt. Håll i kabeln när den kopplas från el-uttaget.

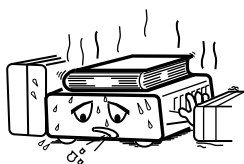

* (For sets with ventilation holes)

- Do not obstruct the ventilation holes.
- Die Belüftungsöffnungen dürfen nicht verdeckt werden.
- Ne pas obstruer les trous d'aération.
- No obstruya los orificios de ventilación.
- De ventilatieopeningen mogen niet worden beblokkeerd.
- Täpp inte till ventilationsöppningarna.

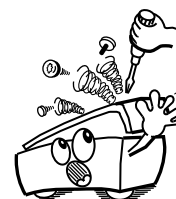

- Never disassemble or modify the set in any way.
- Versuchen Sie niemals das Gerät auseinander zu nehmen oder auf jegliche Art zu verändern.
- Ne jamais démonter ou modifier l'appareil d'une manière ou d'une autre.
- Nunca desarme o modifique el equipo de ninguna manera.
- Nooit dit apparaat demonteren of op andere wijze modificeren.
- Ta inte isär apparaten och försök inte bygga om den.

Main Unit / Hauptgerät / Unité principale / Unidad principal / Hoofdtoestel / Huvudenhet / 主機

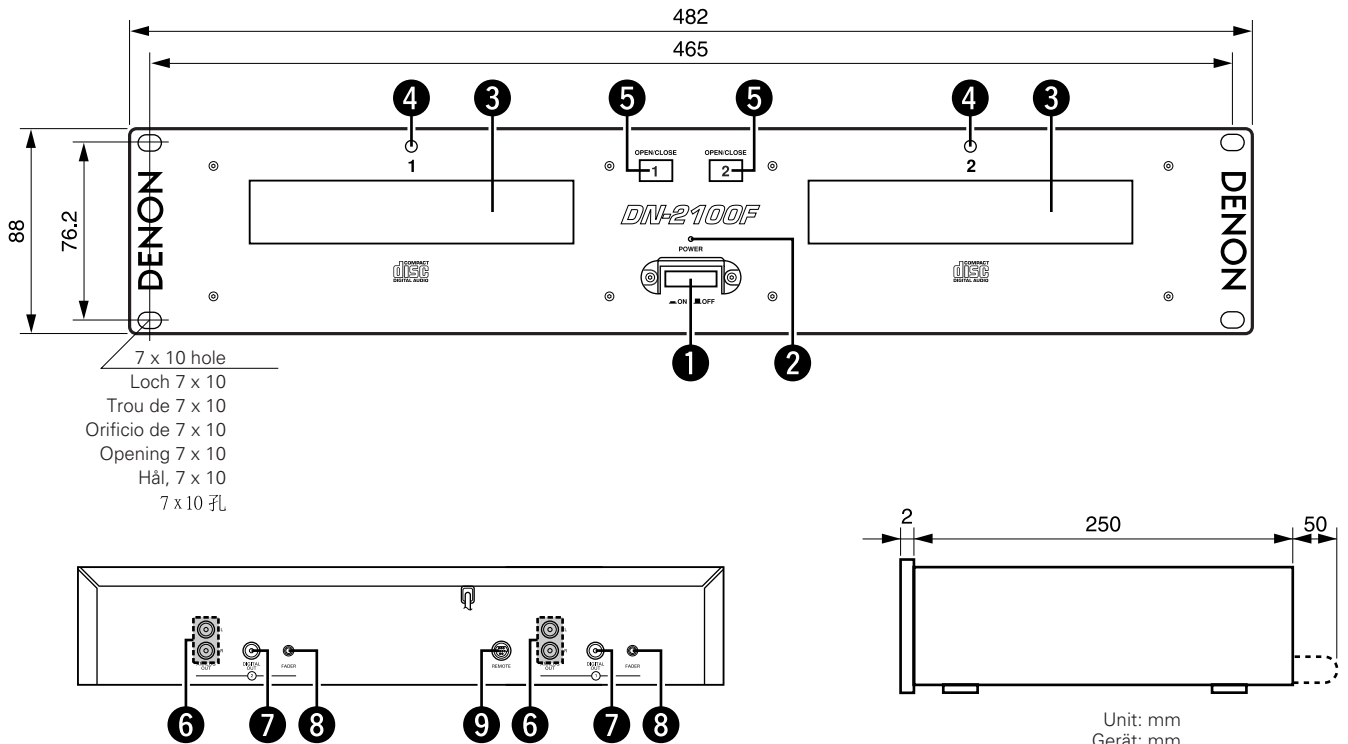

Unit: mm
Gerät: mm
Unité: mm
Unidad: mm
Toestel: mm
Enhet: mm
單位: 毫米

Remote Control Unit / Fernbedienungsgerät / Unité de télécommande / Unidad de control remoto / Afstandsbediening / Fjärrkontroll / 遙控器

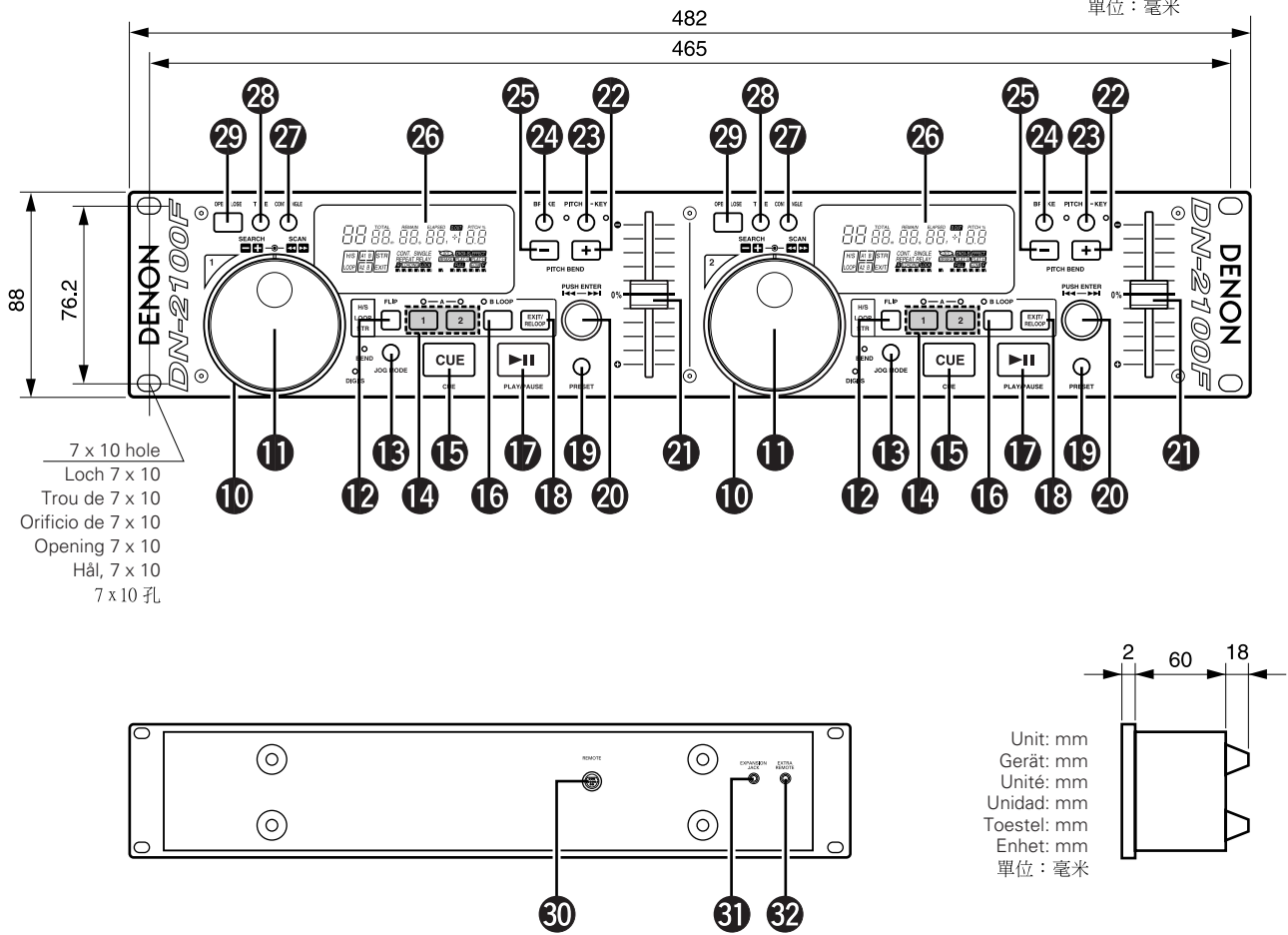

Unit: mm
Gerät: mm
Unité: mm
Unidad: mm
Toestel: mm
Enhet: mm
單位: 毫米

• DECLARATION OF CONFORMITY

We declare under our sole responsibility that this product, to which this declaration relates, is in conformity with the following standards: EN60065, EN55013, EN55020, EN61000-3-2 and EN61000-3-3. Following the provisions of 73/23/EEC, 89/336/EEC and 93/68/EEC Directive.

• ÜBEREINSTIMMUNGSERKLÄRUNG

Wir erklären unter unserer Verantwortung, daß dieses Produkt, auf das sich diese Erklärung bezieht, den folgenden Standards entspricht: EN60065, EN55013, EN55020, EN61000-3-2 und EN61000-3-3. Entspricht den Verordnungen der Direktive 73/23/EEC, 89/336/EEC und 93/68/EEC.

• DECLARATION DE CONFORMITE

Nous déclarons sous notre seule responsabilité que l'appareil, auquel se réfère cette déclaration, est conforme aux standards suivants: EN60065, EN55013, EN55020, EN61000-3-2 et EN61000-3-3. D'après les dispositions de la Directive 73/23/EEC, 89/336/EEC et 93/68/EEC.

• DECLARACIÓN DE CONFORMIDAD

Declaramos bajo nuestra exclusiva responsabilidad que este producto al que hace referencia esta declaración, está conforme con los siguientes estándares: EN60065, EN55013, EN55020, EN61000-3-2 y EN61000-3-3. Siguiendo las provisiones de las Directivas 73/23/EEC, 89/336/EEC y 93/68/EEC.







• EENVORMIGHEIDSVERKLARING

Wij verklaren uitsluitend op onze verantwoordelijkheid dat dit produkt, waarop deze verklaring betrekking heeft, in overeenstemming is met de volgende normen: EN60065, EN55013, EN55020, EN61000-3-2 en EN61000-3-3. Volgens de bepalingen van de Richtlijnen 73/23/EEC, 89/336/EEC en 93/68/EEC.

• ÖVERENSSTÄMMELSESINTYG

Härmed intygas helt på eget ansvar att denna produkt, vilken detta intyg avser, uppfyller följande standarder: EN60065, EN55013, EN55020, EN61000-3-2 och EN61000-3-3. Enligt stadgarna i direktiv 73/23/EEC, 89/336/EEC och 93/68/EEC.



- Use compact discs that include the  mark. CD's with special shapes (heart-shaped CD's, octagonal CD's etc.) cannot be played on this set. Attempting to do so may damage the set. Do not use such CD's.
- Benutzen Sie Compact Discs, die das  Zeichen tragen. Speziell geformte CD's (herzförmige CDs, achteckige CDs, usw.) können auf dieser Anlage nicht abgespielt werden. Der Versuch derartige CDs abzuspielen kann die Anlage beschädigen. Verzichten Sie auf die Benutzung solcher CDs.
- Utiliser des disques compacts portant le logo . Des CD avec des formes spéciales (CD en forme de coeur, des CD octogonaux, etc.) ne peuvent pas être lus sur cet appareil. Le fait de l'essayer, risque d'endommager le lecteur. Ne pas utiliser de tels CD.
- Use discos compactos con la marca . En este equipo no es posible reproducir CDs con formas especiales (CDs con forma de corazón, CDs octogonales, etc.). Si intenta hacerlo, el equipo podrá resultar dañado. No use este tipo de CDs.
- Gebruik compact discs voorzien van het logo . CD's met speciale vormen (bijv. CD's in de vorm van een hart, achthoekige CD's, enz.) kunnen met dit toestel niet worden afgespeeld. Wanneer u dit toch probeert, zal u het toestel beschadigen. Speel dergelijke CD's dus niet af.
- Använd CD-skivor med -märket. Specialformade CD-skivor (hjärtformade, åttkantiga, m m) går inte att spela på den här apparaten. Utrustningen kan skadas om du försöker göra detta. Använd inte CD-skivor av denna typ.



Residue
Rückstand
Résidu
Residuos
Oneffenheden
Plastrester

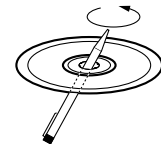

- The disc may not play normally if there is residue along the edges of the center hole.
- When using new discs in particular, use a pen, etc., to remove the residue.
- Die Disk kann nicht normal abgespielt werden, wenn sich ein Rückstand entlang der Mittellochenden befindet.
- Insbesondere, wenn Sie neue Disks benutzen, dann entfernen Sie mit einem Stift, etc. den Rückstand.
- Le disque peut ne pas être lu normalements s'il y a un résidu le long des bord du trou central.
- Lors de l'utilisation de nouveaux disques en particulier, utiliser un stylo à bille, etc., pour enlever le résidu.
- El disco no puede ser reproducido normalmente debido a la terminación deficiente de los bordes del agujero central.
- Para quitar estos residuos de material, especialmente cuando vaya a reproducir discos nuevos, utilice un bolígrafo, o algo similar.
- Het is mogelijk dat de disc niet normaal wordt weergegeven als de randen van het middengat van de schijf oneffenheden vertonen.
- Verwijder vooral bij gebruik van nieuwe discs de oneffenheden met een pen of iets dergelijks.
- Det kan uppstå fel vid CD-avspelningen om det finns plastrester kvar i mitthålet.
- Tänk på att bort dessa med en penna, e d, särskilt om CD-skivan är ny.

— TABLE OF CONTENTS —

1 Main features7	7 Seamless loop/Hot start/Stutter/ Digital scratch14 ~ 16
2 Connections/Installation7	8 Other functions17
3 Part names and functions8 ~ 10	9 Preset functions and operations.....18, 19
4 Compact discs11	10 Cleaning the optical pick-up lens20
5 Basic operation12	11 Specifications20
6 Pitch/Brake/Platter/Key adjust13	

• ACCESSORIES

Check that the following parts are included in addition to the main unit:

1 Operating instructions1	3 Remote control unit (RC-48)1
2 Connection cords for signal output (RCA)2	4 Remote control connection cable1

1 MAIN FEATURES

The DN-2100F is a double CD player equipped with a variety of functions and high performance characteristics. Use it for example for DJ mixing and remixing.

Control section

- 1. The DN-2100F can be easily mounted on a standard 19-inch rack.**
- 2. Improved visibility under low lighting conditions thanks to a large fluorescent display, back-lit illuminated action buttons and illuminated disc trays.**
- 3. Improved interface operation thanks to a large jog/Shuttle wheel and track select knob.**

Functions

- 1. Shockproof function protecting against external vibrations**
- 2. Auto Level Search / Instant Start**
- 3. Pitch Bend (Button & Jog)**
- 4. Seamless Loop**
Playback can be looped between any two points in a track without any break in the audio. Two loop start points (A-1 and A-2) can be set anywhere within the track or disc.
- 5. Hot Start / Stutter**
Playback can be started instantaneously from points A-1 and A-2. In the stutter mode, these same buttons play momentary audio while pressed and held down.
- 6. Digital-Scratch**
This exclusive function emulates vinyl turntable scratching in real time.

7. Brake / Plat-S

In Brake mode, the playing speed comes to a quick halt, simulating the STOP function on a vinyl turntable. In Plat-S mode, it simulates a vinyl turntable's dragging sound when it's power has been purposely turned OFF or ON.

8. Key Adjust

The key can be adjusted automatically when the playback pitch is changed so that the key (vocal) remains the same regardless of the pitch change.

9. Relay Play

When this mode is set, CD1 and CD2 starts playback alternately. This unit can relay the playback of CD1 and CD2 every track or every disc.

10. Power on Play

The player can be set so that playback in the relay mode starts when the power is turned on.

11. Fader Start

Up to 4 loaded Hot Starts can be triggered hands free with any compatible 5 volt pulse mixer by using the crossfader.

12. Auto Sleep Mode / Auto Disc Tray Close System

13. Preset functions - Different presets can be changed according to your needs.

14. EXTRA REMOTE

Wireless control is possible using the Denon RC-8000 and RC-8001ST.

2 CONNECTIONS/INSTALLATION

1. Turn off the POWER switch.
2. Connect the RCA pin cords to the inputs on your mixer.
3. Connect the control cord to the REMOTE connector on the RC-48.

CAUTION:

- Be sure to use the supplied control cord. Using another type of cable may result in damage.
- Be sure the power is off when connecting the control cord. Otherwise the units may not work properly.
- Never connect any remote controllers other than the RC-48. Doing so can damage the equipment.

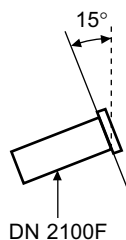

The DN-2100F will work normally when the player unit is mounted within 15 degrees off the vertical plane at the front panel. If the unit is tilted excessively, the disc may not be loaded or unloaded properly.

3 PART NAMES AND FUNCTIONS

(1) DN-2100F Front Panel

1 POWER button (ON OFF)

- Press this button to turn the power on.

NOTE:

- Be sure to close the disc trays before turning off the power.

2 POWER indicator

- This red LED lights up when the power is on.

3 Disc tray

- Place CD discs in this tray.
- Press the disc tray OPEN/CLOSE button to open and close the disc trays.

CAUTION:

- Do not place foreign objects in the disc trays. Doing so could damage the player.
- Never push the disc tray in manually when the power is off. This may result in malfunction or can damage the player.

4 Disc tray LED

- This yellow green LED flashes over the disc trays when opening and closing.
- The LED also shines over the disc trays when opened, which provides sufficient illumination to see the extended disc tray for easy loading.

5 Disc tray OPEN/CLOSE button

- Press this button to open and close the disc tray.
- To prevent accidental ejection, the disc trays will not open.

(2) DN-2100F Rear Panel

6 Analog output jacks 1, 2 (ANALOG OUT 1, 2)

- These are unbalanced RCA output jacks. The audio signals from the CD players are connected to a mixer from these jacks.

7 Digital output jacks 1, 2 (DIGITAL OUT 1, 2)

- Digital output data is available from these jacks only when selected "ON" from the preset menu.
- We recommend using a 75Ω/ohm RCA cord for best digital transfer. (available from any audio/video retailer)

NOTES:

- Turn PITCH control OFF when making digital recordings. Most digital recorders will not accept a variable pitched digital signal.
- The main functions are limited when digital out is selected. (The loop, brake, Plat-H, Plat-S, Jog-Bend, scratch and key adjust functions cannot be used.)

8 Fader Start input jacks 1, 2 (FADER 1, 2)

- To be connected with a compatible 5 volt pulse start mixer. (3.5mm TRS mini jack)
(FADER INPUT LEVEL HCMOS (Ii=-3mA))

- The fader can be activated using the switch circuit shown on the diagram below.

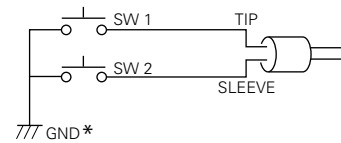

- Connect SW1 to the "TIP" terminal.
- Connect SW2 to the "SLEEVE" terminal.
- Connect GND* to the analog output "SLEEVE" terminal.
- Do not use the "RING" terminal.
- When SW1 is pressed, the hot start play mode selected with the A1 and A2 buttons starts.
- When SW2 is pressed, the hot start play mode stops.
- * Load the hot start data before starting fader playback.

9 Remote control connector (REMOTE)

- Connect this connector to the RC-48 control unit using the included control cord.

(3) RC-48 Front Panel

10 Shuttle ring (outer ring)

- This control is used to select the scanning direction and speed. The CD is scanned in the forward direction when the shuttle ring is turned clockwise from the center position. To scan backwards, the shuttle ring is turned counterclockwise.
- The scanning speed increases as the wheel is turned further. The shuttle ring is always active in any mode except "Digi-Scratch" and "Plat-H".

11 Jog wheel (inner wheel)

- In the search mode, turn this dial during for search operation to find the CUE point in units of frames.
- In the pitch bend and plat-H modes, turn this wheel to change the playing speed.
- In the scratch mode, turn this wheel to scratch.

12 FLIP button

- Press this button to switch between the loop mode/hot start mode and stutter mode.
- The "LOOP" indicator lights when in the loop mode/hot start mode.

13 JOG MODE button

- This button is pressed to select the jog dial operating mode.
 - Manual search mode:** Turn the wheel clockwise to move the playback position forward, counterwise to move the playback position backward.
 - Pitch bend mode:** When the jog wheel is turned in either direction, the playback speed changes within +/- 18% until released. (The green LED Bend indicator lights up.)
 - Plat-H mode:** When the jog wheel is turned in either direction, the playback speed changes within +40% -50% until released. (The green LED Bend indicator flashes.) (The BEND LED and the "PLAT-H" indicator light.)

Scratch mode:

Scratching is possible by turning the jog wheel dial. (The DIGI-S LED flashes.)

14 A1, A2 buttons

- Press these buttons to set the start point for loop playback (point A-1 or A-2).
- Press these buttons to use the stutter and hot start functions.

15 CUE button

- Pressing the CUE button during play provides a return to the position at which play was started. Alternately pressing the PLAY/PAUSE button and the CUE button allows the CD to be played from the same position any number of times.
- The button is lit RED, when in the standby mode.
- When in the sleep mode, press the CUE or PLAY/PAUSE buttons to “wake up” and cancel sleep mode.

16 B-LOOP button

- Press this button to set the end point for loop playback (point B).

17 PLAY/PAUSE button (▶||)

- Use this button to start playback.
- Press once to start playback, once again to set the pause mode, and once more to resume playback.
- In the brake mode, press this button to brake.

18 EXIT/RELOOP button

- When this button is pressed during a seamless loop, the track resumes back to normal play from the B point. (EXIT). When pressed again, the playback jumps back into your A-B seamless loop. (RELOOP)

19 PRESET button

- Press this button once to get into the preset mode. Press it again to save your changes and to get out of this mode.

20 Track select knob (◀◀▶▶/PUSH ENTER)

- Turn this knob to select the first or next track to be played.
- Turn the knob clockwise by one click to move one track forward, counterclockwise by one click to move one track backward.
- When the knob is turned while pressing it down, one click corresponds to advancing 10 tracks at a time.
- In the preset mode, use this knob to set and enter preset settings.

21 Pitch slider

- Use this to adjust the playing speed.
- The playing speed decreases when slid upwards and increases when slid downwards.

22 PITCH BEND + button

- The playing speed increases while this button is pressed.
- When the button is released, the playing speed returns to the previous speed.

23 PITCH/KEY button

- Press this button to activate the playing speed set with the Pitch slider. The PITCH LED lights up green.
- When the button is pressed again, the key adjust mode is turned on and the key remains the same even if the pitch is changed. (KEY ADJUST) The KEY LED flashes.
- Press the button again to cancel the pitch slider, KEY ADJUST and return to normal speed.

- Press the button more than 1 second, the fixed pitch mode is locked and the PITCH LED flashes.

24 BRAKE button

- Press this button to select the brake and the Platter Stop/Start mode. (BRAKE/PLAT-S mode).

25 PITCH BEND – button

- The playing speed decreases while this button is pressed.
- When the button is released, the playing speed returns to the previous speed.

26 FL Tube Display

- See page 10.

27 Continue/Single button (CONT./SINGLE)

- Press this button to switch between the single and continuous play modes.
- The selected mode is indicated by the SINGLE or CONTINUE indicators on the display.
- Press this button for over 1 seconds to turn the repeat mode on and off.

28 TIME button (4-way)

- Press this to switch the time display between the elapsed time or remaining time per track or per disc.

29 Disc tray OPEN/CLOSE button

- Press this button to open and close the disc trays.
- The disc trays are programmed to not open during playback. Stop playback before pressing this button.

(4) DN-2100F Controller (Rear Panel, RC-48)**30 Control connector (8pin din)**

- Connects between the RC-48 (Remote control unit) and the DN-2100F (main unit) using the provided control cable.

31 Connector for signal transfer between remote control units (EXTENSION JACK)

- For the equipment in the future.

32 EXTRA REMOTE

- Connect the Denon RC-8001ST. Connecting the RC-8001ST allows wireless control of the DN-2100F from the RC-8000. The DN-2100F can be controlled using the RC-8000 Denon CD (CD player and CD changer) “PLAY MODE 1/5” system buttons (except that the power cannot be turned on and off). The player to be operated can be selected using the CHANGER 4/5 ZONE1 (CD1) and ZONE2 (CD2) buttons. (The default is CD1.) “10 key 2/5” buttons 1 to 4 can be used as buttons A1 and A2.

1 = CD1 A1 button

2 = CD1 A2 button

3 = CD2 A1 button

4 = CD2 A2 button

Other buttons (5 to RANDOM) cannot be used.

(The RC-8001 charger base stations and RC-8000 remote control unit are sold separately USA, CANADA only)

(5) Display

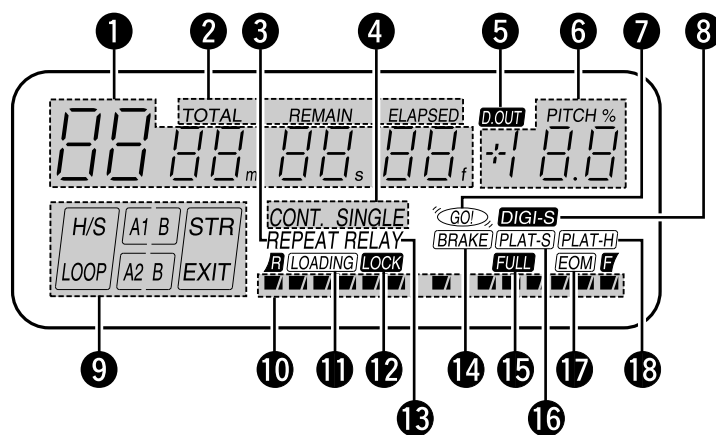

1 Track, minute, second and frame displays

- The display provides information on the current position and track time.

2 Time mode indicators

- When the TIME button is pressed, the time display switches as follows:
When "ELAPSED" is lit:
The track's elapsed time is displayed.
When "REMAIN" is lit:
The track's remaining time is displayed.
When "TOTAL" and "ELAPSED" are lit:
The disc's total elapsed time is displayed.
When "TOTAL" and "REMAIN" are lit:
The disc's total remaining time is displayed.

3 Repeat indicator

- This lights when the repeat mode is set.

4 Play mode indicators

- "SINGLE" lights when in the single track play mode.
- "CONT." lights when in the continuous play mode.

5 Digital out indicator

- This lights when the digital output is turned on within the preset mode.

6 Pitch display

- This indicates the playback speed (pitch).
(-16.0 to +16.0 max)

7 Digital scratch enabled indicator

- This lights when it is possible to start digital scratching.

8 ASP mode indicators

- "DIGI-S" lights when the ASP is set to the digital scratch mode.

9 Loop mode indicators

- "LOOP" lights when in the loop mode.
- "A1 B" lights when point B is set for point A-1.
- "A2 B" lights when point B is set for point A-2.
- "EXIT" lights when in the seamless loop EXIT mode.
- "H/S" light when in the hot start mode.
- "STR" lights when in the stutter mode.
- "LOADING" lights when data is being loaded in A1 or A2.

10 Bar indicator

- This provides a visual indication of where the pickup is within the currently playing track.

11 LOADING indicator

- This lights while data is being loaded in the memory.
The indicator flashes three times if the data cannot be loaded.

12 Button lock indicator

- Some of the buttons do not function when this indicator is lit

13 Relay indicator

- This lights when the relay mode is set.

14 Brake indicator

- This lights when in the brake mode.

15 Shockproof data indicator

- This lights when the shockproof memory is full.

16 PLAT-S indicator

- This lights when in the PLAT-START/STOP mode.

17 EOM indicator

- The End Of Message indicator provides a visual warning by flashing to indicate your currently playing track is about to end. The end time can be adjusted in the presets.

18 PLAT-H indicator

- This lights when in the PLAT-H mode.

4 COMPACT DISCS

1. Precautions on handling compact discs

- Always wash your hands before before you get started!
- Do not allow fingerprints, oil or dust to get on the surface of the CD disc.
If the disc is dirty, wipe it off gently with a soft dry cloth.
- Do not use benzene, thinner, water, record spray, electrostatic-proof chemicals, or silicone-treated cloths to clean discs.
- Always handle discs carefully to prevent damaging the surface; in particular when removing a disc from its jewel case and returning it.
- Do not bend the disc.
- Do not apply heat.
- Do not enlarge the hole in the center of the disc.
- Do not write on the label (printed side) with a hard-tipped implement such as a pencil or ball point pen.
- Condensation will form if a disc is brought into a warm area from a colder one, such as outdoors in winter. Do not attempt to dry the disc with a hair dryer, etc.

2. Precautions on storage

- After playing a disc, always unload it from the player.
- Always store the disc in the jewel case to protect from dirt or damage.
- Do not place discs in the following areas:
 - 1) Areas exposed to direct sunlight for a considerable time.
 - 2) Areas subject to accumulation of dust or high humidity.
 - 3) Areas affected by heat from indoor heaters, etc.

5 BASIC OPERATION

PLAY/PAUSE and CUE

- ★ The operation switches between play and pause each time the PLAY/PAUSE button is pressed.
- ★ When the CUE button is pressed during playback, the pickup returns to the position at which playback was started.

The diagrams below show playback patterns when the PLAY/PAUSE and CUE buttons are pressed.

PLAY and PAUSE

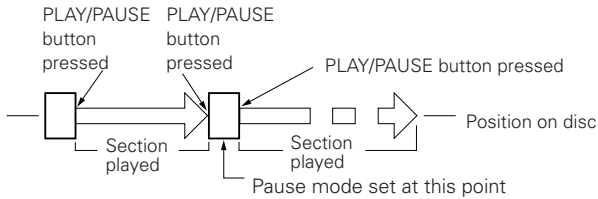

When the PLAY/PAUSE button is pressed, playback starts and proceeds as shown by the arrow on the diagram above. If the PLAY/PAUSE button is pressed again during playback, the pause mode is set at that point. Press the PLAY/PAUSE button again to resume playback.

PLAY and CUE

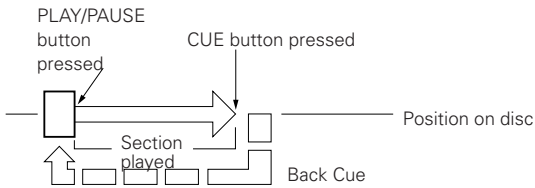

When the CUE button is pressed after starting playback by pressing the PLAY/PAUSE button, the pickup returns to the position at which playback was started and prepares for the next playback. Press the PLAY/PAUSE and CUE buttons alternately to start playback repeatedly from the same position. (Checking the playback position) This function is called "Back Cue".

PLAY, PAUSE and CUE

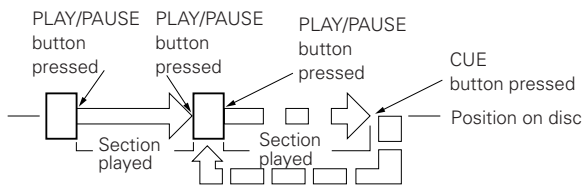

If the pause mode is set and playback is then resumed, the position to which the pickup returns with the Back Cue function changes.

Sleep mode

- The sleep mode is set if no operation is performed for 30 minutes while in the standby or pause mode. In the sleep unnecessary wear to the internal parts.
- The sleep mode can be canceled by pressing the PLAY/PAUSE or CUE button.

Starting playback from the Middle of a track (Manual Search)

- ★ Once the track is selected with the track select knob and the PLAY/PAUSE button is pressed, playback starts from the beginning of that track. If you wish to start from a different position, use the procedure described below to search for the desired position.

Find the play start position.

Press the JOG MODE button to select the jog/shuttle wheel to the search mode.

Turn the shuttle ring to change the playback position quickly. (Search for the approximate playback position.)

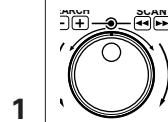

The fast forward/reverse mode is set when the shuttle ring (outer) is turned. The speed changes according to the angle at which the ring is turned.

1

RVS FWD

- When operated during playback, playback resumes after the operation.
- When playback is started, the jog wheel is set to the bend mode.
- When turned fully in either direction, the disc skips 1 minute forward or backward then plays for 3 seconds, and continues until released.

Turn the jog wheel. (Search for the precise playback position.)

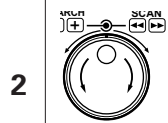

2

RVS FWD

When the jog wheel (inner side) is turned, the frame search mode is set. The playback position can be moved in units of one frame.

Listen to the track and find the desired play start position.

Shockproof memory

- A maximum of approximately 10 seconds uncompressed audio data is stored into memory (per drive). This guards audible interruptions due to external mechanical shocks such as bumps or other hard vibrations.
- If advanced data reading is not possible due to scratches or dirt on the disc, playback stops once the data stored up to that point is read.
- If less than 3 seconds worth of data remains in the memory, track, minute, second and frame displays flashes, indicating that playback will stop.
- The display returns to normal once the amount of data in the memory increases.

6 PITCH/BRAKE/PLATTER/KEY ADJUST

- ★ There are two ways to change the playing speed.
 - Adjust the Pitch using the pitch slider ($\pm 10\%$ or $\pm 16\%$).
 - The PITCH BEND button or jog wheel can be used to temporarily change the pitch.
- ★ The playing speed can be changed greatly to achieve effects similar to vinyl turntable.

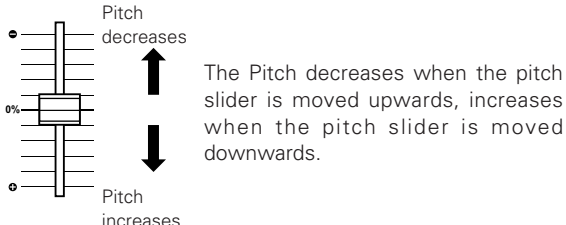
Pitch/Plat-H	
1-1	<p>[Pitch slider] Set the variable speed mode. Press the PITCH/KEY button to light the PITCH LED.</p>
1-2	 <p>The Pitch decreases when the pitch slider is moved upwards, increases when the pitch slider is moved downwards.</p> <ul style="list-style-type: none"> • The pitch can be locked by pressing the PITCH/KEY button more than 1 second. • Press the PITCH/KEY button more than 1 second again to cancel the pitch lock.
2-1	<p>[PITCH BEND button] Press the PITCH BEND + (or PITCH BEND -) button.</p> <ul style="list-style-type: none"> • The Pitch increases or decreases temporarily while the PITCH BEND + or PITCH BEND - button is pressed. • The extent to which the PITCH BEND button changes the Pitch is proportionate to the amount of time the button is pressed. The longer the button is held down, the greater percentage of change.
2-2	<p>Jog bend mode. During play mode, pitch bend is the default setting for the Jog wheel. The BEND LED is on.</p> <ul style="list-style-type: none"> • The playing speed increases gradually when the jog wheel is turned clockwise and decreases gradually when the jog wheel is turned counterclockwise. When you stop turning the jog wheel, the playing speed returns to the previous reference speed. • When playback is stopped, the jog/shuttle wheel is set to the search mode.
3	<p>Set the jog dial to the platter hold mode. Press the JOG MODE button once so that the green BEND LED is flashing.</p> <ul style="list-style-type: none"> • The playing speed changes in function of the speed at which the jog wheel is turned, resulting in a sound similar to a vinyl turntable. • The playing speed increases when the jog wheel is turned clockwise and decreases when the jog wheel is turned counterclockwise. When you stop turning the jog wheel, the playing speed returns to the previous reference speed.

Brake/Plat-S	
<p>★ Use this function to achieve two effects similar to vinyl turntable.</p>	
1	<p>Select the brake or platter mode. Press the BRAKE button.</p> <ul style="list-style-type: none"> • Displays " BRAKE " when set to Brake mode The effect sound is similar to a DJ turntable coming to a quick stop. This effect can be achieved by pressing the PLAY/PAUSE button during playback. • Displays " PLAT-S " when set to Platter Start/Stop mode The platter stop effect is achieved when the PLAY/PAUSE button is pressed during playback and the platter start effect is achieved when the PLAY/PAUSE button is pressed in the CUE standby or pause mode. The platter stop and start effects are effect sounds similar to a turntable's dragging.
Key Adjust	
<p>★ Key adjust function adjusts the key automatically when the playing pitch changes so that the key always remains the same.</p>	
1	<p>[Key adjust mode] Compensate for the change in the key when the playing speed is changed with the pitch slider. Press the PITCH/KEY button (above the pitch slider) to make the KEY LED flash.</p> <ul style="list-style-type: none"> • The key is kept at the same key as when the pitch is 0 %.

7 SEAMLESS LOOP/HOT START/STUTTER/DIGITAL SCRATCH

LOOP/HOT START/STUTTER

- ★ DN-2100F's ASP (Audio Signal Processor) has two modes - seamless loop and digital scratch - that can be selected freely according to the purpose.
- ★ Use this function to play the specified section between points A and B in a seamless loop (with no break in the sound).
- ★ Two A points and one B point can be set.
- ★ The data of the A points are also used for the hot starts and stutter functions.

Digital scratch

- The jog wheel can be used to scratch with a feeling similar to when scratching with a vinyl turntable.

(1) SEAMLESS LOOP/HOT START/ STUTTER

Starting seamless loop playback

- ★ This can be operated when the seamless loop mode is selected in the preset mode.

1	<p>Start playback. Press the PLAY/PAUSE button.</p>
2	<p>Load the start point (A). Press the A-1 (or A-2) button.</p> <ul style="list-style-type: none"> • The seamless loop indicator is displayed as soon as point A is set. • The "LOCK" and "LOADING" indicator lights while the A point data is being loaded. • The two "A" points can be set anywhere within the same disc. * Data cannot be loaded for both A1 and A2 at the same time. * Depending on the conditions, it may not be possible to load points A1 and A2.
3	<p>Set the end point (B). Press the B-LOOP button.</p> <p>Start point End point</p> <p>When the end point (B) is set, the disc is played from the start point (A) with no break.</p> <p>Point B is selected with respect to point A for which the "A" indicator is lit.</p> <p>After this, the disc is played from the start point (A) to the end point (B) with no break.</p> <p>Seamless loop</p> <ul style="list-style-type: none"> • If the B-LOOP button is pressed again after the B point has been set, the B point is reset (moves). This allows you to make your seamless Loop shorter or longer "on the fly". • Whenever the A-1 (or A-2) button is pressed while in the seamless loop mode, playback starts over from the A point. • When point B is set for point A-1 and the A-2 button is pressed, point B is cleared. In the same way, when point B is set for point A-2 and the A-1 button is pressed, point B is cleared.

Exiting a seamless looping

4	<p>Press the EXIT/RELOOP button during seamless looping. (EXIT mode)</p> <ul style="list-style-type: none"> • When the end point of (B) is reached, playback continues seamlessly, from that point onward.
----------	---

Re-entering a seamless loop

5	<p>Press the EXIT/RELOOP button to seamlessly jump back into your A-B loop during playback of the same track or disc. When the B-LOOP button is pressed, that point is now set as the new loop end point (B).</p> <p>Start point End point</p> <p>Press the EXIT/RELOOP or B-LOOP button.</p> <ul style="list-style-type: none"> • Playback returns to the start point (A) and seamless looping resumes.
----------	--

Clearing the A-B seamless loop

6

While holding down the FLIP button, press the A button you want to clear (A-1 or A-2) for at least 2 seconds.

- The A-1 point (or A-2 point) and the B point are cleared.

NOTE:

- When the disc tray is opened, the start (A) and end (B) point settings are cleared.

Clearing all data

7

Press the FLIP button for at least 2 seconds.

- All data is cleared when the the flip button is held down for 2 seconds.

NOTE:

- When A-1 or A-2 is cleared during seamless looping, it may take about 2 seconds before A-1 or A-2 can be set again.

Fine-adjusting the start points (A-1 and A-2) and end point (B)

★ The A-1, A-2 and B points can also be adjusted in the standby mode at their respective points.

1

Adjust the start point (A).
To fine-adjust the position of the A-1 (or A-2) point once it has been set, in the standby mode press and hold down the CUE button then push the "A" button that you wish to edit.

- The stanby mode is now set to edit/fix either A-1 or A-2 points.

2

Use the Jog/Shuttle wheel to manually search through the track in order to find your desired new start point. When found, press the same "A" button to resave.

3

Adjust the end point (B).
Follow the same steps from 1 & 2 above, except, press and hold the CUE button and then the B button in order to edit your end B point, Then press the B button again to save your changes.

NOTE:

- It is not possible to set an A point at a position after the B point or the B point at a position before the A point. " **LOADING** " indicator will flashed.

Hot Starts

★ Hot starting is possible during a seamless loop or even without a B point being set.

1

With the data for A-1 or A-2 loaded, press the A-1 (or A-2) button to hot start.

- Playback starts immediately from the start point (A) when the button is pressed.
- The A-1 or A-2 points can be set in advance so that in front of a live audience, you are able to jump from A to A on the fly. (slam-mix)
- * "H/S" is displayed once a hot start has been loaded.
- * While data is loading, hot start is only possible for that point (A-*)

Stuttering

★ Stuttering is possible only when the seamless loop mode is off and the A1 or A2 points have been loaded.

1	<p>In the stutter mode, press the A-1 (or A-2) button.</p> <ul style="list-style-type: none"> • Playback starts immediately from the start point (A) when the button is pressed and stops when the button is released. • "STR" indicator lights. <p>* When the PLAY/PAUSE button is pressed in the above mode, playback begins immediately from that start point (A).</p>
----------	---

NOTE:

- When the " **LOCK** " indicator is lit, it is not possible to set the pause mode or to use the manual search and scan functions.

(2) Digital scratch

Using the scratch function

This can be operated when the digital scratch mode is selected in the preset mode.

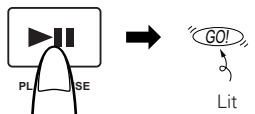
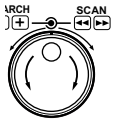
1	<p>Set the ASP to the scratch mode. (The Digi-S led starts flashing)</p> <ul style="list-style-type: none"> • Refer to "Preset function" on page 19.
2	<p>Check that it is possible to start scratching. Press the PLAY/PAUSE button.</p> <div style="text-align: center;">  </div> <ul style="list-style-type: none"> • If the " GO! " indicator is lit, scratching is possible.
3	<p>* The DIGI-S LED lights when scratching is performed once.</p>
4	<p>Change the playing speed and direction of playback. Turn the Jog wheel.</p> <div style="display: flex; align-items: flex-start;"> <div style="margin-right: 20px;">  </div> <div> <p>The disc is played in the forward direction when the jog wheel is turned clockwise, in the reverse direction when the jog wheel is turned counterclockwise. The playing speed changes according to the speed at which the jog wheel is turned.</p> </div> </div> <ul style="list-style-type: none"> • When the scratch operation is performed during normal playback, normal playback resumes once scratching is stopped. • If the scratch operation is performed in the pause mode, the pause mode is set once scratching is stopped.

8 OTHER FUNCTIONS

1. Relay play

- ★ The unit can play CD1 and CD2 alternately.
- ★ The relay mode can be selected in the preset mode. (Preset item 3)

(1) Single relay mode

1	<p>Press the CONT./SINGLE button several times until "SINGLE" and "RELAY" indicator are lit on the display.</p> <ul style="list-style-type: none"> • When the play finish the desired track, another CD will be started the play. • When both CD1 and CD2 set to the SINGLE RELAY mode, endless play are available to the each track of CD1 and CD2 alternately.
----------	--

(2) Continuous relay mode

1	<p>Press the CONT./SINGLE button several times until "CONTINUOUS" and "RELAY" indicator are lit on the display.</p> <ul style="list-style-type: none"> • When the play finish the final track of disc, another CD will be started the play. • When both CD1 and CD2 set to the CONTINUOUS RELAY mode, endless play are available to the each disc of CD1 and CD2 alternately.
----------	---

(3) Combined with single, continuous, single relay and continuous relay mode

1	<p>The combination with RELAY PLAY mode and SINGLE, CONTINUOUS PLAY mode, or SINGLE RELAY and CONTINUOUS RELAY PLAY mode are also available.</p> <p>For example: When CD1 is set to the CONTINUOUS RELAY PLAY mode and CD2 is set to the CONTINUOUS PLAY mode.</p> <ul style="list-style-type: none"> • When start the play from CD1, play can be stopped after play the final track of CD2.
----------	--

2. Repeat play

- ★ Repeat playback is possible in units of tracks or discs, depending on the play mode.
- ★ When playing with the repeat mode turned on, the blank sections between tracks are cut.

(1) Single repeat mode

1	<p>In the single mode, the single repeat play mode is set when the CONT./SINGLE button is pressed for over 1 second.</p> <ul style="list-style-type: none"> • Repeat playback is performed in units of tracks.
----------	---

(2) Continuous repeat mode

1	<p>In the continuous play mode, the continuous repeat play mode is set when the CONT./SINGLE button is pressed for over 1 second.</p> <ul style="list-style-type: none"> • Repeat playback is performed in units of discs.
----------	---

NOTES:

- When playing track ends in the repeat mode, the blank sections are cut so the " **LOCK** " indicator lights. The manual search, scan and pause operation cannot be performed, the play mode cannot be set and the repeat mode cannot be turned on and off when the " **LOCK** " indicator is lit.
- The relay mode and repeat mode cannot be selected at the same time.

3. Disc tray auto close

1	<p>Disc tray will automatically close after 30 seconds or so have elapsed in the disc tray auto close mode. Preset item 7.</p>
----------	--

4. End of message

1	<p>During playback, the "EOM" indicator starts flashing when the remaining playing time to the end of the track set in the preset mode is reached, indicating that the end of the track is near. Preset item 5.</p>
----------	---

5. Power on play

1	<p>Single relay playback starts automatically when the power is turned on.</p> <ul style="list-style-type: none"> • The " LOCK " indicator lights in the power on play mode. • Playback is performed in the continuous repeat mode when a disc is only loaded in one CD player. • Normal playback resumes when the CONT./SINGLE button is pressed.
----------	--

9 PRESET FUNCTIONS AND OPERATIONS

(1) Preset functions

- ★ Use these functions to preset the DN-2100F's operation modes. These presets are stored in permanent memory, so they are not cleared even when the power is turned off.
- ★ The functions shown on page 19 can be adjusted to your preference. Set these functions according to your needs for more efficient operation.

(2) Preset change procedure

- ★ The preset procedure can be performed in the cue, pause mode, when no disc is loaded or when the disc trays is open.

1	<p>Set the preset operation selection mode. Press the PRESET button.</p>
2	<p>Select the preset item. Turn the Track Select knob (◀◀▶▶).</p> <div style="text-align: center;"> <p>The diagram shows a 'PUSH ENTER' button with a right-pointing arrow. To its right is a vertical sequence of four display screens connected by downward arrows. The screens show: 15-L 00 P, 2 R -CUE On, 3 r EL R4 OF, and 0 PS CL OF. A grey box highlights the last three screens.</p> </div> <p>Turn the knob clockwise to move in the direction of the arrows, counterclockwise to move in the opposite direction.</p> <p>* The first preset item displayed is the last preset item displayed the last time the presettings were made.</p>

3	<p>Change the setting. Press the Track Select knob (◀◀▶▶).</p> <ul style="list-style-type: none"> • When the Track Select knob (◀◀▶▶) is turned, the player returns to the same status as in step 2.
4	<p>Cancel the preset mode. Press the PRESET or PLAY/PAUSE or CUE button.</p>

<p>NOTE:</p> <ul style="list-style-type: none"> • If the message shown below appears, there is a problem with the preset memory. Contact a Denon authorized service station. <p style="text-align: center;"><i>PS Err</i></p>

(3) Detailed Description of Preset Functions

("*" indicates the default setting.)

- (0) Preset Clear: This restores the preset data to the factory default values.
 - ① The presettings are initialized when the TRACK SELECT knob is turned while set to "0 PS CL On".
 - ② "0 PS CL OF" is displayed when initialization is completed.
- (1) DSP play function selection: Selects the DSP mode playback function.
 - * "1 S-LOOP" : Seamless loop play mode
 - "1 digi-S" : Scratch mode
- (2) Auto Cue ON/OFF
 - * "2 A-CUE On" : The cue point is detected at a sound level of -54 dB.
 - "2 A-CUE OF" : Cue detection is not performed.
- (3) Relay mode function selection: The relay playback mode can be selected with the CONT./SINGLE button.
 - "3 rELAY On" : The relay play mode can be selected.
 - * "3 rELAY OF" : The relay play mode cannot be selected.
- (4) Digital Out
 - "4 D-Out On" : Digital data is output. (NOTE: The operable functions are limited.)
 - * "4 D-Out OF" : Digital data is not output.
- (5) E.O.M
 - * "5 End OF" : No end of message is emitted.
 - "5 End (setting time)" : Set the end of message time. (10, 15, 20, 30, 60 or 90)
- (6) Pitch Range
 - "6 Pitch (setting value)" : Select the pitch adjustment range (16, *10).
- (7) Auto Close: Set the disc tray auto close mode.
 - "7 CLOSE OF" : The disc trays do not close automatically.
 - "7 CLOSE (setting time) " : Set the time from which the disc tray is opened until it is closed automatically (10, *30 or 60).
- (8) Power on play: Single relay playback starts automatically when the power is turned on.
 - "8 P-On P On" : Power on play on
 - * "8 P-On P OF" : Power on play off
- (9) Play Mode: Set the play mode which is set when the power is turned on.
 - * "9 Single" : Playback ends at the end of the track.
 - "9 Cont" : Playback continues until the end of the disc.
- (10) Time Mode: Set the time mode which is set when the power is turned on.
 - "10 ELAPS" : The elapsed time per track is displayed.
 - * "10 rEMAI n" : The remaining time per track is displayed.
 - "10 t-ELAPS" : The elapsed time per disc is displayed.
 - "10 t-rEMA In" : The remaining time per disc is displayed.

10 CLEANING THE OPTICAL PICK-UP LENS

Necessity of cleaning might be differed on location and frequency of use per each player.

It is recommend to clean the pick-up lens once a week.

We recommend using DENON's AMC-22 PICK-UP LENS CLEANER.

If failure may occur, we recommend having your unit professionally serviced by Denon itself or one of many authorized service centers to keep your machine in optimum performance condition.

11 SPECIFICATIONS

GENERAL

Type:	Twin mechanism compact disc player with wired remote control		
Disc type:	Standard compact discs (12 cm and 8 cm discs)		
Dimensions:	Player unit:	482 (W) x 88 (H) x 252 (D) mm (without feet)	18-31/32" (W) x 3-15/32" (H) x 9-59/64" (D)
	Remote control unit:	482 (W) x 88 (H) x 62 (D) mm (without feet)	18-31/32" (W) x 3-15/32" (H) x 2-7/16" (D)
Installation:	19-inch rack mountable		
	Player unit:	2U	
	Remote control unit:	2U	
Mass:	Player unit:	6 kg (13.23 lbs.)	
	Remote control unit:	1.5 kg (3.3 lbs.)	
Power supply:	U.S.A., Canada and Taiwan R.O.C. models:	120 V AC	±10%, 60 Hz
	European models:	230 V AC	±10%, 50 Hz
Power consumption:	21 W		
Environmental conditions:	Operational temperature:	5 to 35°C	(41 to 95°F)
	Operational humidity:	25 to 85%	(no condensation)
	Storage temperature:	-20 to 60°C	(4 to 140°F)

AUDIO SECTION

Quantization:	16-bit linear per channel
Sampling frequency:	44.1 kHz at normal pitch
Oversampling rate:	8 times
Frequency response:	20 to 20,000 Hz
Analog output	
Output level:	2.0 V
Digital output	
Signal format:	SPDIF
Output level:	0.5 V _{p-p} 75 Ω/ohms
Load impedance:	10 kΩ/kohms or more

FUNCTIONS

Instant start:	Within 20 msec.	
Variable pitch:	10% range:	±10% or more
	16% range:	±16% or more
Pitch bend:	±18% or more	
Search precision:	1/75 sec. (1 subcode frame)	
Max. scan speed:	Over 20 times normal speed	

* Specifications and design are subject to change without notice for purpose of improvement.