

DENON *PROFESSIONAL*

CD PLAYER

DN-C100

OPERATING INSTRUCTIONS

BEDIENUNGSANLEITUNG

MODE D'EMPLOI

ISTRUZIONI PER L'USO

INSTRUCCIONES DE FUNCIONAMIENTO

GEBRUIKSAANWIJZING

BRUKSANVISNING

SAFETY PRECAUTIONS



CAUTION
RISK OF ELECTRIC SHOCK
DO NOT OPEN



CAUTION:
TO REDUCE THE RISK OF ELECTRIC SHOCK, DO NOT REMOVE COVER (OR BACK). NO USER-SERVICEABLE PARTS INSIDE. REFER SERVICING TO QUALIFIED SERVICE PERSONNEL.

The lightning flash with arrowhead symbol, within an equilateral triangle, is intended to alert the user to the presence of uninsulated "dangerous voltage" within the product's enclosure that may be of sufficient magnitude to constitute a risk of electric shock to persons.

The exclamation point within an equilateral triangle is intended to alert the user to the presence of important operating and maintenance (servicing) instructions in the literature accompanying the appliance.

WARNING:
TO REDUCE THE RISK OF FIRE OR ELECTRIC SHOCK, DO NOT EXPOSE THIS APPLIANCE TO RAIN OR MOISTURE.

CLASS 1 LASER PRODUCT
LUOKAN 1 LASERLAITE
KLASS 1 LASERAPPARAT

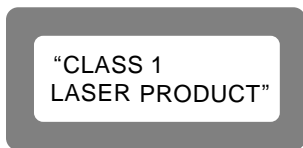

ADVARSEL: USYNLIG LASERSTRÅLING VED ÅBNING, NÅR SIKKERHEDSafbrydere er ude af funktion. Undgå udsættelse for stråling.

VAROITUS: LAITTEEN KÄYTTÄMINEN MUULLA KUIN TÄSSÄ KÄYTTÖOHJEESSA MAINITULLA TAVALLA SAATTAA ALTISTAA KÄYTTÄJÄN TURVALLISUUSLUOKAN 1 YLITTÄVÄLLE NÄKYMÄTTÖMÄLLE LASERSÄTEILYLLE. OM APPARATEN ANVÄNDS PÅ ANNAT SÄTT ÄN I DENNA BRUKSANVISNING SPECIFICERATS, KAN ANVÄNDAREN UTSÄTTAS FÖR OSYNLIG LASERSTRÅLNING SOM ÖVERSKRIDER GRÄNSEN FÖR LASERKLASS 1.

WARNING:

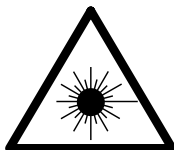







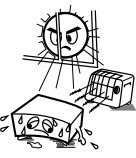

ATTENZIONE: QUESTO APPARECCHIO E' DOTATO DI DISPOSITIVO OTTICO CON RAGGIO LASER. L'USO IMPROPRIO DELL'APPARECCHIO PUO' CAUSARE PERICOLOSE ESPOSIZIONI A RADIAZIONI!

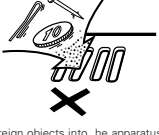
CAUTION:
USE OF CONTROLS OR ADJUSTMENTS OR PERFORMANCE OF PROCEDURES OTHER THAN THOSE SPECIFIED HEREIN MAY RESULT IN HAZARDOUS RADIATION EXPOSURE. THIS PRODUCT SHOULD NOT BE ADJUSTED OR REPAIRED BY ANYONE EXCEPT PROPERLY QUALIFIED SERVICE PERSONNEL.

- **DECLARATION OF CONFORMITY**
We declare under our sole responsibility that this product, to which this declaration relates, is in conformity with the following standards: EN60065, EN55013, EN55020, EN61000-3-2 and EN61000-3-3. Following the provisions of 73/23/EEC, 89/336/EEC and 93/68/EEC Directive.
- **ÜBEREINSTIMMUNGSERKLÄRUNG**
Wir erklären unter unserer Verantwortung, daß dieses Produkt, auf das sich diese Erklärung bezieht, den folgenden Standards entspricht: EN60065, EN55013, EN55020, EN61000-3-2 und EN61000-3-3. Entspricht den Verordnungen der Direktive 73/23/EEC, 89/336/EEC und 93/68/EEC.
- **DECLARATION DE CONFORMITE**
Nous déclarons sous notre seule responsabilité que l'appareil, auquel se réfère cette déclaration, est conforme aux standards suivants: EN60065, EN55013, EN55020, EN61000-3-2 et EN61000-3-3. D'après les dispositions de la Directive 73/23/EEC, 89/336/EEC et 93/68/EEC.
- **DICHIARAZIONE DI CONFORMITÀ**
Dichiariamo con piena responsabilità che questo prodotto, al quale la nostra dichiarazione si riferisce, è conforme alle seguenti normative: EN60065, EN55013, EN55020, EN61000-3-2 e EN61000-3-3. In conformità con le condizioni delle direttive 73/23/EEC, 89/336/EEC e 93/68/EEC. QUESTO PRODOTTO E' CONFORME AL D.M. 28/08/95 N. 548
- **DECLARACIÓN DE CONFORMIDAD**
Declaramos bajo nuestra exclusiva responsabilidad que este producto al que hace referencia esta declaración, está conforme con los siguientes estándares: EN60065, EN55013, EN55020, EN61000-3-2 y EN61000-3-3. Siguiendo las provisiones de las Directivas 73/23/EEC, 89/336/EEC y 93/68/EEC.
- **EENVORMIGHEIDSVERKLARING**
Wij verklaren uitsluitend op onze verantwoordelijkheid dat dit produkt, waa op deze verklaring betrekking heeft, in overeenstemming is met de volgende normen: EN60065, EN55013, EN55020, EN61000-3-2 en EN61000-3-3. Volgens de bepalingen van de Richtlijnen 73/23/EEC, 89/336/EEC en 93/68/EEC.
- **ÖVERENSSTÄMMELSESINTYG**
Härmed intygas helt på eget ansvar att denna produkt, vilken detta intyg avser, uppfyller följande standarder: EN60065, EN55013, EN55020, EN61000-3-2 och EN61000-3-3. Enligt stadgarna i direktiv 73/23/EEC, 89/336/EEC och 93/68/EEC.

NOTE ON USE / HINWEISE ZUM GEBRAUCH / OBSERVATIONS RELATIVES A L'UTILISATION / NOTE SULL'USO / NOTAS SOBRE EL USO / ALVORENS TE GEBRUIKEN / OBSERVERA

 <ul style="list-style-type: none"> Avoid high temperatures. Allow for sufficient heat dispersion when installed in a rack. Vermijden Sie hohe Temperaturen. Beachten Sie, daß eine ausreichend Luftzirkula ion gewährleistet wird, wenn das Gerät auf ein Regal gestellt wird. Eviter des températures élevées Tenir compte d'une dispersion de chaleur suf isante lors de l'installation sur une étagère. Evitate di esporre l'unità a temperature alte. Assicuratevi che ci sia un'adeguata dispersione del calore quando installate l'unità in un mobile per componen i audio. Evite altas temperaturas Permite la suficiente dispersión del calor cuando está instalado en la consola. Vermijd hoge temperaturen. Zorg voor een dege ijk hitteafvoer indien het apparaat op een rek wordt geplaatst. Undvik höga temperaturer. Se ill att det inns möjlighet till god värmeavledning vid montering i ett rack. 	 <ul style="list-style-type: none"> Keep he apparatus free from moisture, water, and dust. Halten Sie das Gerät von Feuchtigkeit, Wasser und Staub fern. Protéger l'appareil contre l'humidité, l'eau et lapoussiére. Tenete l'unità lontana dall'umidità, dall'acqua e dalla polvere. Mantenga el equipo l bre de humedad, agua y polvo. Laat geen vocht iigheid, water of stof in het apparaat binnendringen. Utsätt inte apparaten för fukt, vatten och damm. 	 <ul style="list-style-type: none"> Do not let foreign objects into he apparatus. Keine fremden Gegenstände in das Gerät kommen lassen. Ne pas laisser des objets étrangers dans l'appareil. E' importante che nessun oggetto è inserito all'interno dell'unità. No deje objetos extraños dentro del equipo. Laat geen vreemde voorwerpen in dit apparaat vallen. Se ill att främmande föremål inte tränger in i apparaten. 	<p>CAUTION:</p> <ul style="list-style-type: none"> The ventila ion should not be impeded by covering the ven ilation openings with items, such as newspapers, tablecloths, curtains, etc. No naked flame sources, such as lighted candles, should be placed on he apparatus. Atten ion should be drawn to the environmental aspects of battery disposal. Do not expose he set to dripping or splashing liquids. No objects filled with liquids, such as vases, shall be placed on he apparatus. <p>ACHTUNG:</p> <ul style="list-style-type: none"> Die Belüftung sollte auf keinen Fall durch das Abdecken der Belüftungsöffnungen durch Gegenstände wie beispielsweise Zeitungen, Tischtücher, Vorhänge o. Ä. behindert werden. Auf dem Gerät sollten keinerlei direkten Feuerquellen wie beispielsweise angezündete Kerzen aufgestellt werden. Bitte beachten Sie bei der Entsorgung der Batterien die geltenden Umweltafbes immungen. Das Gerät sollte keinerlei Flüssigkeit, also keinem Tropfen oder Spritzen ausgesetzt werden. Auf dem Gerät sollten keinerlei mit Flüssigkeit gefüllten Behälter wie beispielsweise Vasen aufgestellt werden.
 <ul style="list-style-type: none"> Handle he power cord carefully. Hold he plug when unplugging the cord. Gehen Sie vorsichtig mit dem Netzkabel um. Halten Sie das Kabel am Stecker, wenn Sie den Stecker herausziehen. Manipuler le cordon d'alimenta ion avec précau ion. Tenir la prise lors du débranchement du cordon. Maneggiare il ilo di alimentazione con cura. Agite per la spina quando scollegate il cavo dalla presa. Maneje el cordón de energía con cuidado. Sostenga el enchufe cuando desconecte el cordón de energía. Hanteer het netsnoer voorzich ig. Houd het snoer bij de stekker vast wanneer deze moet worden aan- of losgekoppeld. Hantera nätkabeln varsamt. Håll i kabeln när den kopplas från el-uttaget. 	 <ul style="list-style-type: none"> Unplug he power cord when not using he apparatus for long periods of ime. Lassen Sie das Gerät eine längere Zeit nicht verwendet werden soll, trennen Sie das Netzkabel vom Netzstecker. Débrancher le cordon d'alimenta ion lorsque l'appareil n'est pas u ilisé pendant de longues périodes. Disinnestare il ilo di alimentazione quando avete l'intenzione di non usare il filo di alimentazione per un lungo periodo di tempo. Desconecte el cordón de energía cuando no u ilice el equipo por mucho tiempo. Neem alt jd het netsnoer uit het stopkontakt wanneer het apparaat gedurende een lange periode niet wordt gebruikt. Koppla ur nätkabeln om apparaten inte kommer att användas i lång id. 	 <ul style="list-style-type: none"> Do not let insecticides, benzene, and thinner come in contact with he apparatus. Lassen Sie das Gerät nicht mit Insektiziden, Benzin oder Verdünnungsmitteln in Berührung kommen. Ne pas mettre en contact des insecticides, du benzène et un diluant avec l'appareil. Assicuratevi che l'unità non venga in contatto con inset icidi, benzolo o solventi. No permita el contacto de insecticidas, gasolina y diluyentes con el equipo. Laat geen insectenverdelgende middelen, benzine of verdunndner met dit apparaat in kontakt komen. Se ill att inte insektsmedel på spraybruk, bensin och thinner kommer i kontakt med apparatens hölje. 	<p>ATTENTION:</p> <ul style="list-style-type: none"> La ven ilation ne doit pas être gênée en recouvrant les ouvertures de la ventila ion avec des objets tels que journaux, rideaux, issus, etc. Aucune flamme nue, par exemple une bougie, ne doit être placée sur l'appareil. Veillez à respecter l'environnement lorsque vous jetez les piles usagées. L'appareil ne doit pas être exposé à l'eau ou à l'humidité. Aucun objet contenant du liquide, par exemple un vase, ne doit être placé sur l'appareil. <p>PRECAUZIONI:</p> <ul style="list-style-type: none"> Le aperture di ven ilazione non devono essere ostruite coprendole con oggetti, quali giornali, tovaglie, tende e così via. Non posizionare sull'apparechiatura fiamme libere, come ad esempio le candele accese. Prestare attenzione agli aspetti i lega i alla tutela dell'ambiente quando si smaltisce la batteria. L'apparechiatura non deve essere esposta a gocciolii o spruzzi. Non posizionare sull'apparechiatura nessun oggetto contenete liquidi, come ad esempio i vasi. <p>PRECAUCIÓN:</p> <ul style="list-style-type: none"> La ventilación no debe quedar obstruida por hacerse cubierto las aperturas con objetos como periódicos, manteles, cortinas, etc. No debe colocarse sobre el aparato ninguna fuente in lamable sin protección, como velas encendidas. A la hora de deshacerse de las pilas, respete la norma iva para el cuidado del medio ambiente. No se expondrá el aparato al goteo o salpicaduras cuando se utilice. No se colocarán sobre el aparato objetos llenos de líquido, como jarras.
 <ul style="list-style-type: none"> Handle he power cord carefully. Hold he plug when unplugging the cord. Gehen Sie vorsichtig mit dem Netzkabel um. Halten Sie das Kabel am Stecker, wenn Sie den Stecker herausziehen. Manipuler le cordon d'alimenta ion avec précau ion. Tenir la prise lors du débranchement du cordon. Maneggiare il ilo di alimentazione con cura. Agite per la spina quando scollegate il cavo dalla presa. Maneje el cordón de energía con cuidado. Sostenga el enchufe cuando desconecte el cordón de energía. Hanteer het netsnoer voorzich ig. Houd het snoer bij de stekker vast wanneer deze moet worden aan- of losgekoppeld. Hantera nätkabeln varsamt. Håll i kabeln när den kopplas från el-uttaget. 	 <p>* (For apparatuses with ven ilation holes)</p> <ul style="list-style-type: none"> Do not obstruct the ven ilation holes. Die Belüftungsöffnungen dürfen nicht verdeckt werden. Ne pas obstruer les trous d'aération. Non coprite i fori di ventilazione. No obstruya los orificios de ven ilación. De ven ila ieopeningen mogen niet worden blokkeerd. Täpp inte ill ven ilationsöppningarna. 	 <ul style="list-style-type: none"> Never disassemble or modify the apparatus in any way. Versuchen Sie niemals das Gerät auseinander zu nehmen oder auf jegliche Art zu verändern. Ne jamais démonter ou modi ier l'appareil d'une manière o d'une autre. Non smontate mai, né modificate l'unità in nessun modo. Nunca desarme o modi ique el equipo de ninguna manera. Nooit dit apparaat demonteren of op andere wijze modi ieren. Ta inte isär apparaten och försök inte bygga om den. 	<p>WAARSCHUWING:</p> <ul style="list-style-type: none"> De ventila ie mag niet worden belemmerd door de ven ilatieopeningen af te dekken met bijvoorbeeld kranten, een tafelkleed, gordijnen, enz. Plaats geen open vlammen, bijvoorbeeld een brandende kaars, op het apparaat. Houd u steeds aan de milieuvoorschriften wanneer u gebruikte batterijen wegdoet. Stel het apparaat niet bloot aan druppels of spatten. Plaats geen voorwerpen gevuld met water, bijvoorbeeld een vaas, op het apparaat. <p>OBSERVERA:</p> <ul style="list-style-type: none"> Ventila ionen bör inte förhindras genom att täcka för ven ila ionsöppningarna med föremål såsom tidningar, bordsdukar, gardiner osv. Inga blottade brandkällor, såsom tända ljus, bör placeras på apparaten. Tänk på miljöaspekterna när du bortskaffar batterien. Apparaten får inte utsättas för vätska. Inga objekt med vätskor, såsom vasar, får placeras på apparaten.

A NOTE ABOUT RECYCLING:

This product's packaging materials are recyclable and can be reused. Please dispose of any materials in accordance with the local recycling regulations.

When discarding the unit, comply with local rules or regulations.

Batteries should never be thrown away or incinerated but disposed of in accordance with the local regulations concerning chemical waste.

This product and the accessories packed together constitute the applicable product according to the WEEE directive except batteries.



HINWEIS ZUM RECYCLING:

Das Verpackungsmaterial dieses Produktes ist für zum Recyceln geeignet und kann wieder verwendet werden. Bitte entsorgen Sie alle Materialien entsprechend der örtlichen Recycling-Vorschriften.

Beachten Sie bei der Entsorgung des Gerätes die örtlichen Vorschriften und Bestimmungen.

Die Batterien dürfen nicht in den Hausmüll geworfen oder verbrannt werden; bitte geben Sie die Batterien gemäß örtlichen Bestimmungen an den Sammelstellen oder Sondermüllplätzen ab.

Dieses Produkt zusammen mit den Zubehörteilen ist das geltende Produkt der WEEE-Direktive, davon ausgenommen sind die Batterien.

UNE REMARQUE CONCERNANT LE RECYCLAGE:

Les matériaux d'emballage de ce produit sont recyclables et peuvent être réutilisés. Veuillez disposer de tout matériau conformément aux règlements de recyclage locaux.

Lorsque vous mettez cet appareil au rebut, respectez les lois ou réglementations locales.

Les piles ne doivent jamais être jetées ou incinérées, mais mises au rebut conformément aux règlements locaux concernant les déchets chimiques.

Ce produit et les accessoires emballés ensemble sont des produits conformes à la directive DEEE sauf pour les piles.

NOTA RELATIVA AL RICICLAGGIO:

I materiali di imballaggio di questo prodotto sono riutilizzabili e riciclabili. Smaltire i materiali conformemente alle normative locali sul riciclaggio.

Per smaltire l'unità, osservare la normativa in vigore nel luogo di utilizzo.

Non gettare le batterie, né incenerirle, ma smaltirle conformemente alla normativa locale sui rifiuti chimici.

Questo prodotto e gli accessori inclusi nell'imballaggio sono applicabili alla direttiva RAEE, ad eccezione delle batterie.

ACERCA DEL RECICLAJE:

Los materiales de embalaje de este producto son reciclables y se pueden volver a utilizar. Disponga de estos materiales siguiendo los reglamentos de reciclaje de su localidad.

Cuando se deshaga de la unidad, cumpla con las reglas o reglamentos locales.

Las pilas nunca deberán tirarse ni incinerarse. Deberá disponer de ellas siguiendo los reglamentos de su localidad relacionados con los desperdicios químicos.

Este producto junto con los accesorios empacutados es el producto aplicable a la directiva RAEE excepto pilas.

EEN AANTEKENING WAT BETREFT HET RECYCLEREN:

Het inpakmateriaal van dit product is recycleerbaar en kan opnieuw gebruikt worden. Er wordt verzocht om zich van elk afvalmateriaal te ontdoen volgens de plaatselijke voorschriften.

Volg voor het wegdoen van de speler de voorschriften voor de verwijdering van wit- en bruinoed op.

Batterijen mogen nooit worden weggegooid of verbrand, maar moeten volgens de plaatselijke voorschriften betreffende chemisch afval worden verwijderd.

Op dit product en de meegeleverde accessoires, m.u.v. de batterijen is de richtlijn voor afgedankte elektrische en elektonische apparaten (WEEE) van toepassing.

EN KOMMENTAR OM ÅTERVINNING:

Produktens emballage är återvinningsbart och kan återanvändas. Kassera det enligt lokala återvinningsbestämmelser. När du kasserar enheten ska du göra det i överensstämmelse med lokala regler och bestämmelser.

Batterier får absolut inte kastas i soporna eller brännas. Kassera dem enligt lokala bestämmelser för kemiskt avfall.

Denna apparat och de tillbehör som levereras med den är de som uppfyller gällande WEEE-direktiv, med undantag av batterierna.

CAUTION:

To completely disconnect this product from the mains, disconnect the plug from the wall socket outlet.

The mains plug is used to completely interrupt the power supply to the unit and must be within easy access by the user.

VORSICHT:

Um dieses Gerät vollständig von der Stromversorgung abzutrennen, trennen Sie bitte den Netzstecker von der Wandsteckdose ab.

Die Hauptstecker werden verwendet, um die Stromversorgung zum Gerät völlig zu unterbrechen; er muss für den Benutzer gut und einfach zu erreichen sein.

PRECAUTION:

Pour déconnecter complètement ce produit du courant secteur, débranchez la prise de la prise murale.

La prise secteur est utilisée pour couper complètement l'alimentation de l'appareil et l'utilisateur doit pouvoir y accéder facilement.

ATTENZIONE:

Per scollegare definitivamente questo prodotto dalla rete di alimentazione elettrica, togliere la spina dalla relativa presa.

La spina di rete viene utilizzata per interrompere completamente l'alimentazione all'unità e deve essere facilmente accessibile all'utente.

PRECAUCIÓN:

Para desconectar completamente este producto de la alimentación eléctrica, desconecte el enchufe del enchufe de la pared.

El enchufe de la alimentación se utiliza para interrumpir por completo el suministro de alimentación a la unidad y debe encontrarse en un lugar al que el usuario tenga fácil acceso.

VOORZICHTIGHEID:

Om de voeding van dit product volledig te onderbreken moet de stekker uit het stopcontact worden getrokken.

De netstekker wordt gebruikt om de stroomtoevoer naar het toestel volledig te onderbreken en moet voor de gebruiker gemakkelijk bereikbaar zijn.

FÖRSIKTIGHETSMÅTT:

Koppla loss stickproppen från eluttaget för att helt skilja produkten från nätet.

Stickproppen används för att helt bryta strömförsörjningen till apparaten, och den måste vara lättillgänglig för användaren.

Getting Started

Thank you for purchasing this DENON PROFESSIONAL CD Player. Please read the operation instructions thoroughly in order to acquaint yourself with the CD player and achieve maximum satisfaction from it.
Be sure to keep these instructions for future reference, should any questions or problems arise.

Contents	
Getting Started	
Accessories.....	2
Before using.....	2
About discs	
Discs usable on this set.....	2
Holding discs.....	2
Loading discs.....	2
Cautions on loading discs.....	3
Cautions on handling.....	3
Cautions on storing discs.....	3
Cleaning discs.....	3
About the remote control unit	
Inserting the batteries.....	3
Operating range of the remote control unit.....	3
Part names and functions	
Front panel.....	4
Display.....	4
Rear panel.....	5
Remote control unit.....	5
Connections	
Cable indications.....	6
Analog connections.....	6
Digital connections.....	6
Connecting the power supply cord.....	6
Operation	
Turning the power on.....	7
Loading discs.....	7
Starting playback.....	7
To stop playback.....	7
To pause playback.....	7
Fast-forwarding and fast-reversing through tracks (Search).....	7
Moving to the beginning of tracks (Skip).....	8
Playing the desired track (Direct play).....	8
Listening to specific tracks in a specific order (Programmed play).....	
Listening in random order (Random playback).....	8
Listening to tracks repeatedly (Repeat play)	
Listening to all the tracks repeatedly (All-track repeat play).....	9
Listening to a specific track repeatedly (1-track repeat play).....	9
Listening to a specific section between two points repeatedly (A-B repeat play).....	9
Cuing and stopping playback (Pause)	
Cuing with direct searching.....	9
Cuing with programmed searching.....	9
Using the timer play function.....	9
Others	
Troubleshooting.....	10
Specifications.....	10

Getting Started

Accessories

Check that the following parts are attached in addition to the main unit:

① Operating instructions	1
② Service station list.....	1
③ Remote control unit (RC-1028)	1
④ R03/AAA batteries	2
⑤ Pin-plug cable (Cable length: Approx. 1.0 m).....	1

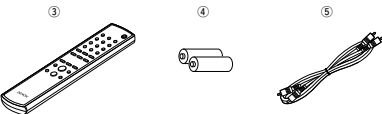

Before using

- **Handle the power supply cord carefully.**
Do not damage or deform the power supply cord. If it is damaged or deformed, it may cause electric shock or malfunction when used. When disconnecting the power supply cord from the wall outlet, hold the plug and do not pull on the cable.
- **Do not open the top cover.**
In order to prevent electric shock, do not open the top cover. If problems occur, contact your DENON PROFESSIONAL dealer.
- **Do not place anything inside.**
Prevent metal objects from entering the CD player and avoid spilling liquids on it. Electric shock or malfunction may result.
- **Cautions on moving.**
First, if a disc is loaded, eject it, then turn off the power, unplug the power supply cord from the power outlet and disconnect the connection cables with other devices.
- **Cautions on using mobile phones.**
Using a mobile phone near this unit may result in noise. If so, move the mobile phone away from this unit when it is in use.
- **Sufficiently ventilate the place of installation.**
If the unit is left in a room full of the smoke from cigarettes, etc., for long periods of time, the surface of the optical pickup could get dirty, in which case it will not be able to read the signals properly.

- **Store the operating instructions in a safe place.**
After reading the operating instructions, store them in a safe place as they could come in handy in the future.
- **Note that the illustrations in these instructions may differ from the actual unit for explanation purposes.**

NOTE:

- This CD player uses a semiconductor laser. To ensure stable operation, it is recommended to use the set indoors at a temperature of 5°C (41°F) ~ 35°C (95°F).

About discs

Discs usable on this set

- ① **Music CDs**
Discs with the mark at the right can be used on this set. Note however that discs with special shapes (heart-shaped discs, octagonal discs, etc.) cannot be played. Do not attempt to play them, as doing so could damage the set.

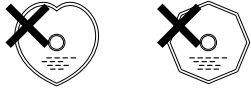

- ② **CD-R/CD-RW**
 - Some discs and some recording formats may not be playable.
 - Non-finalized discs cannot be played.

※ **Finalization:**
Finalization is the process that makes recorded CD-R/CD-RW discs playable on compatible players.

Holding discs

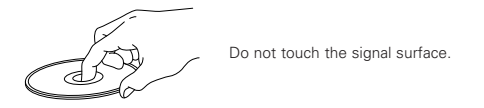

Getting Started

Loading discs

- Set the disc with the labeled side facing up.
- Make sure the disc tray is fully open when inserting the disc.
- Place the discs flatly, 12 cm discs in the outer tray guide (Figure 1), 8 cm discs in the inner tray guide (Figure 2).

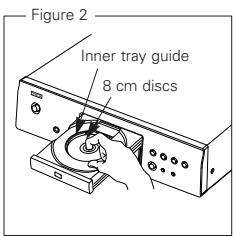
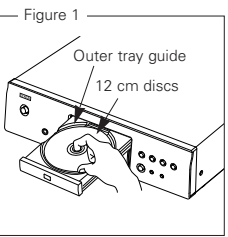

- Place 8 cm discs in the inner tray guide without using an adapter.
- "NO DISC" is displayed if a disc is loaded upside down or if no disc is loaded.

Getting Started

Cautions on loading discs

- Only load one disc at a time. Loading two or more discs can damage the set or scratch the discs.
- Do not use cracked or warped discs or discs that have been repaired with adhesive, etc.
- Do not use discs on which the sticky part of cellophane tape or labels is exposed or on which there are traces of where labels have been removed. Such discs could get caught inside the player and damage it.

Cautions on handling

- Do not get fingerprints, oil or dirt on discs.
- Take special care not to scratch discs when removing them from their cases.
- Do not bend or heat discs.
- Do not enlarge the hole at the center.
- Do not write on the labeled (printed) surface with ball-point pens, pencils, etc., or stick new labels on discs.
- Water droplets may form on discs if they are moved suddenly from a cold place (outdoors for example) to a warm place, but do not try to dry them off using a hairdryer, etc.

Cautions on storing discs

- Be sure to remove discs after using them.
- Be sure to store discs in their cases to protect them from dust, scratches, warping, etc.
- Do not store discs in the following places:
 1. Places exposed to direct sunlight for long periods of time
 2. Dusty or humid places
 3. Places exposed to heat from heating appliances, etc.

Cleaning discs

- If there are fingerprints or dirt on discs, wipe them off before using the disc. If not the sound quality could be reduced and the sound may be broken.
- Use a commercially available disc cleaning set or a soft cloth to clean discs.

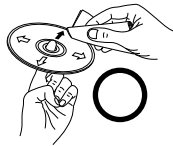

Gently wipe the disc from the inside towards the outside.

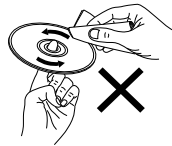

Do not wipe with a circular motion.

NOTE:

- Do not use record spray, antistatic agents, or benzene, thinner or other solvents.

About the remote control unit

Inserting the batteries

- ① Remove the remote control unit's rear cover.
- ② Set two R03/AAA batteries in the battery compartment in the indicated direction.

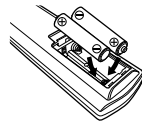
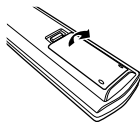

- ③ Put the rear cover back on.

Getting Started

Notes on batteries:

- Replace the batteries with new ones if the set does not operate even when the remote control unit is operated nearby the unit. (The attached batteries are only for verifying operation.)
- When inserting the batteries, be sure to do so in the proper direction, following the “+” and “-” marks in the battery compartment.
- To prevent damage or leakage of battery fluid:
 - Do not use a new battery together with an old one.
 - Do not use two different types of batteries.
 - Do not short-circuit, disassemble, heat or dispose of batteries in flames.
- If the battery fluid should leak, carefully wipe the fluid off the inside of the battery compartment and insert new batteries.
- Remove the batteries from the remote if it will not be in use for long periods.

Operating range of the remote control unit

- Point the remote control unit at the remote sensor when operating it.
- The remote control unit can be used from a distance of up to about 8 meters, at a horizontal angle of up to 30° with respect to the sensor.

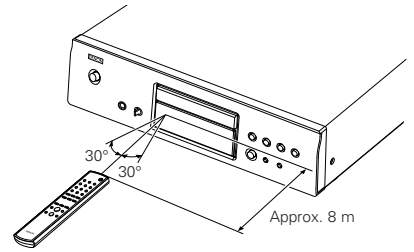

NOTE:

- It may be difficult to operate the remote control unit if the remote sensor is exposed to direct sunlight or strong artificial light.

Getting Started

Part names and functions

For buttons not explained here, see the page indicated in parentheses ().

Front panel

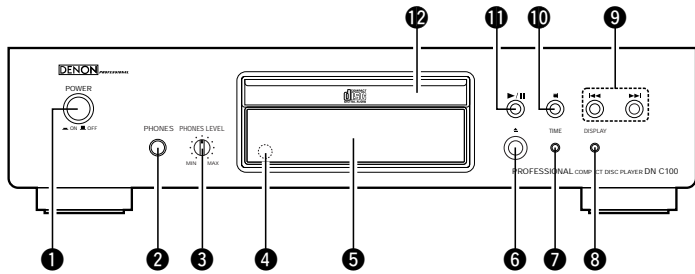

- 1 POWER switch(7)
- 2 PHONES jack
Insert the headphones' plug.
- 3 PHONES LEVEL knob
Adjusts the volume of the headphones.
- 4 Remote control sensor(3)
- 5 Display(4)
- 6 Disc tray open/close button (▲)(7)
- 7 TIME button(7)
- 8 DISPLAY button
 Switching the display brightness
 The brightness switches as shown below each time the button is pressed (and released within 1 second).

Normal brightness	→	Approx. 2/3 the normal brightness
Entire display off *	←	Approx. 1/3 the normal brightness

 * Some of the display remains lit if no disc is playing or loaded.
- 9 Skip buttons (|◀◀, ▶▶|)(8)
- 10 Stop button (■)(7)
- 11 Play/Pause button (▶/||)(7)
- 12 Disc tray(2)

Getting Started

Display

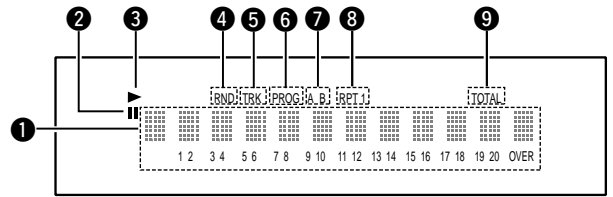

- 1 Information display
Various information is displayed here, depending on the operation mode.
For a music CD:
 • Total number of tracks
 • Total playing time
 • Track number
 • Elapsed time, etc.
 • 20-track music calendar
 • Program number
- 2 Lights when the pause mode is set.
- 3 Lights when a disc is playing.
- 4 Lights when in the random play mode.
- 5 Lights when the track number is displayed.
- 6 Lights when in the program play mode.
- 7 Lights when in the A-B repeat play mode.
- 8 Lights when in the repeat play mode.
The display switches as follows each time the REPEAT button on the remote control unit is pressed.
 • In modes other than the folder mode:

RPT All-track repeat	→	RPT 1 (One-track repeat)
Not displayed	←	Not displayed
- 9 Lights when the total number of tracks and total time are displayed at 1.

Getting Started

Rear panel

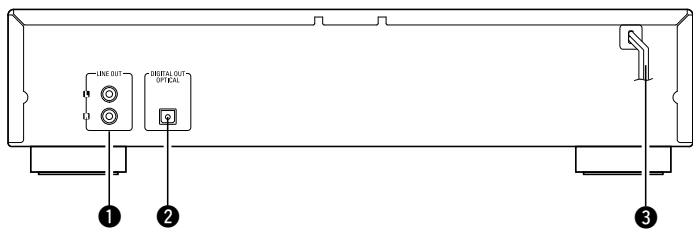

- ❶ LINE OUT terminals(6)
- ❷ DIGITAL OUT OPTICAL terminal(6)
- ❸ Power supply cord(6)

Getting Started

Remote control unit

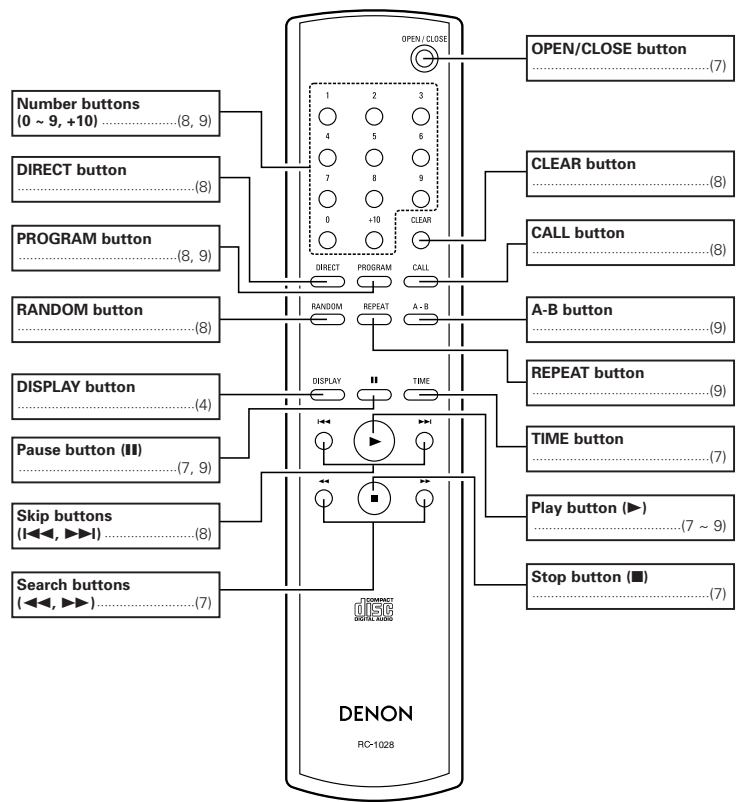

• The skip buttons (I◀◀ and ▶▶I) and +10 button operate continuously when held in.





Connections

NOTE:

- Do not plug in the power supply cord until all connections have been completed.
- When making connections, also refer to the operating instructions of the other components.
- Be sure to connect the left and right channels properly (left with left, right with right).
- Making connections with the power turned on could result in noise or damage the speakers.
- Bunching the power supply cords and connection cables together could result in humming or noise.

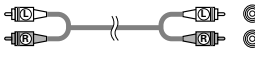
Cable indications

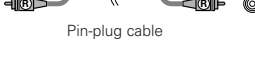
Connect using the connection cables shown below.

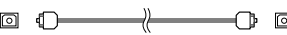
Audio cable	Signal direction
<p>A Analog connections (Stereo)</p> <p>(White)   </p> <p>(Red)   </p> <p>Pin-plug cable</p>	<p>Audio signal</p> <p></p> <p>OUT IN</p>
<p>B Digital connections (Optical)</p> <p></p> <p>Optical fiber cable</p>	

Analog connections

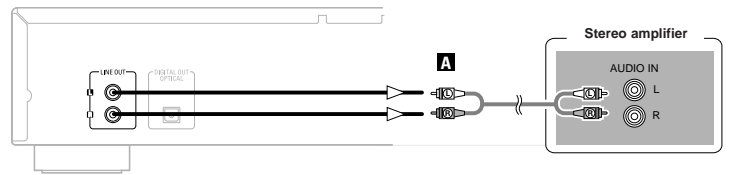

Connections

Digital connections

There is a protective cap over the optical digital output terminal. Remove the protective cap and insert the plug firmly until it locks.

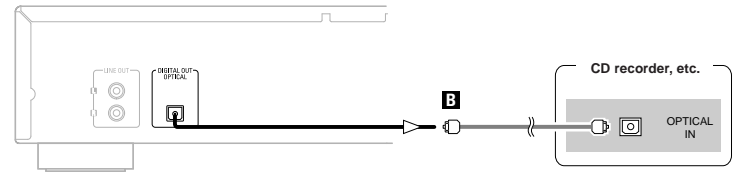

When connecting the optical digital output connector with an optical transmission cable (commercially available)

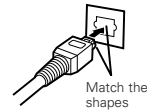

Match the shapes then insert firmly all the way in.

Connecting the power supply cord

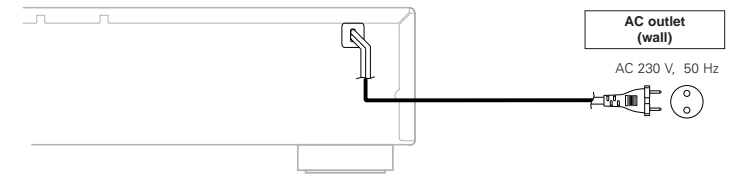

NOTE:

- Insert the plugs securely. Incomplete connections will result in the generation of noise.
- Do not unplug the power supply cord while the set is operating.

Operation

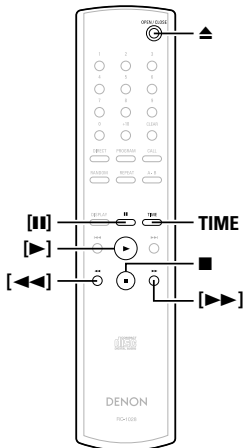
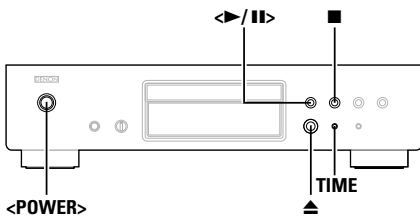

Turning the power on

Press <POWER>.

- When a disc is loaded, playback starts automatically.
- If no disc is loaded "NO DISC" is displayed.

To turn off the power:

Press <POWER> again.

NOTE:

- To turn off the power while a disc is playing, be sure to press [STOP] to stop playback before turning off the power.

Loading discs

(See page 2)

Press [OPEN] to open the disc tray.

To close the disc tray:

Press [OPEN] again.

NOTE:

- Be sure to turn on the power when opening and closing the disc tray.
- Do not push the disc tray in by hand when the power is off. Doing so could damage it.
- Do not insert foreign objects into the disc tray. Doing so will damage it.

Starting playback

Press <PLAY/PAUSE> or [PLAY].

- The "▶" indicator lights and playback starts.

* Once all the tracks recorded on the disc have been played, the stop mode is set automatically.

* TIME can be used to switch the information displayed.

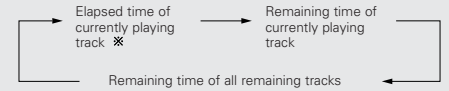

* During programmed playback, the remaining time of all the programmed tracks is displayed.

To stop playback

Press [STOP] during playback.

To pause playback

Press <PLAY/PAUSE> or [PAUSE] during playback.

- The "⏸" indicator lights and the pause mode is set.

To resume playback:

Press <PLAY/PAUSE> or [PLAY].

Fast-forwarding and fast-reversing through tracks (Search)

Press and hold [FF] or [RR] during playback.

* Normal playback resumes when you release your finger from the button.



- The sound may be interrupted shortly when resuming normal playback after searching.

About the button names in this explanation

< > : Buttons on the main unit

[] : Buttons on the remote control unit

Button name only :

Buttons on the main unit and remote control unit

○

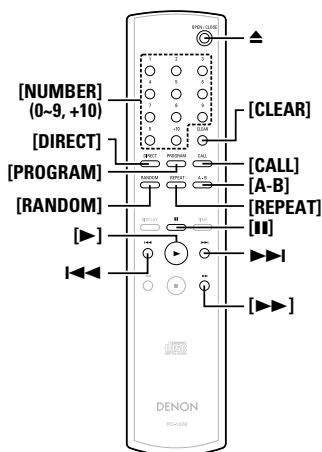
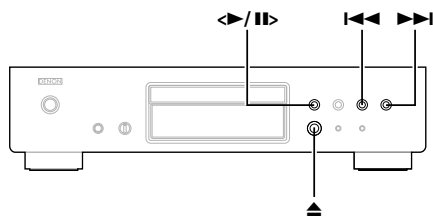

About the button names in this explanation
 < > : Buttons on the main unit
 [] : Buttons on the remote control unit
Button name only :
 Buttons on the main unit and remote control unit

Moving to the beginning of tracks (Skip)

Press **⏮** or **⏭** during playback.
 ※ The operation is as follows if the button is held in:
⏭: Skip to the beginning of tracks several tracks on
⏮: Skip to the beginning of tracks several tracks before

Playing the desired track (Direct play)

Use **[NUMBER] (0 ~ 9, +10)** to select the track.
 ※ For track numbers 1 to 9, press the corresponding button ([1] to [9]).
 For track numbers 10 and on, first press **[+10]** then press buttons [0] to [9].
Example: Track 4 : [4]
Example: Track 12 : [+10] [2]
Example: Track 20 : [+10] [+10] [0]

Listening to specific tracks in a specific order (Programmed play)

Up to 25 tracks can be programmed.
1 In the stop mode, press **[PROGRAM]**.
 • "PROG" is displayed.
2 Use **[NUMBER] (0 ~ 9, +10)** to select the track.
Example: To program tracks 3, 12, 7 to play in that order:
 [3] [+10] [2] [7]
3 Press **⏮/⏭** or **⏭**.
 • The tracks are played in the programmed order.

Checking the programmed tracks:
 In the stop mode, press **[CALL]**.
 The tracks are displayed in the programmed order each time the button is pressed.

Clearing tracks from the program:
 ① Press **[CLEAR]** while the track you want to clear is displayed during the "Checking the programmed tracks" operation above.
 ② The last track in the program is deleted each time the button is pressed.

Stopping programmed playback:
 In the stop mode, press **[DIRECT]**, or press **⏏** to open the disc tray.

Direct searching is not possible during programmed playback.
 • "-- : --" is displayed if the total programmed time exceeds 100 minutes.
 • If the end of the track is reached while **⏭** is being pressed during programmed playback, the track following the currently playing track is played, regardless of the program.

Listening in random order (Random playback)

1 In the stop mode, press **[RANDOM]**.
 • The "RND" indicator lights.
2 Press **⏮/⏭** or **⏭**.
 • During normal playback:
 Tracks are selected automatically and played in random order.
 • During programmed playback:
 The programmed tracks are played in random order.
 • In the all-track repeat mode:
 The tracks are played once each in random order, then played again in a different order.

Stopping random playback:
 Press **[RANDOM]** or **[DIRECT]**.

Direct searching is not possible during random playback.

Listening to tracks repeatedly (Repeat play)

Listening to all the tracks repeatedly (All-track repeat play)

1 Press **[REPEAT]** once.

- The "RPT" indicator lights.

2 Press **<>/II>** or **[▶]**.

- During normal playback: All the tracks are played repeatedly.
- During programmed playback: The tracks are played repeatedly in the programmed order.
- In the random play mode: The tracks are played once each in random order, then played again in a different order.

Stopping all-track repeat playback:
Press **[REPEAT]** twice in a row, or press **▲** to open the disc tray.

In the programmed play or random play mode during all-track repeat playback, normal playback resumes when **[REPEAT]** is pressed once.

Listening to a specific track repeatedly (1-track repeat play)

During playback, press [REPEAT] twice in a row.

- The "RPT1" indicator lights and that track is played repeatedly.

Stopping 1-track repeat playback:
Press **[REPEAT]** again, or press **▲** to open the disc tray.

1-track repeat playback is not possible during programmed or random playback.

Listening to a specific section between two points repeatedly (A-B repeat play)

1 During playback, press **[A-B]** at the point at which you want to start repeating (point A).

- The "A-" indicator lights.

2 During playback, press **[A-B]** at the point at which you want to stop repeating (point B).

- The "A-B" indicator lights and the A-B section is played repeatedly.

Stopping A-B repeat playback:
Press **[A-B]** again.

A-B repeat playback is not possible during programmed playback or random playback.

Cuing and stopping playback (Pause)

Cuing with direct searching

1 Either press **<>/II>** twice or press **[II]** once.

2 Use **[NUMBER]** (0 ~ 9, +10) to select the track.

To start playback:
Press **<>/II>** or **[▶]**.

Cuing with programmed searching

1 Press **[PROGRAM]**.

2 Use **[NUMBER]** (0 ~ 9, +10) to select the track.

3 Either press **<>/II>** twice or press **[II]** once.

To start playback:
Press **<>/II>** or **[▶]**.

Using the timer play function

Also refer to the operating instructions of the timer device.

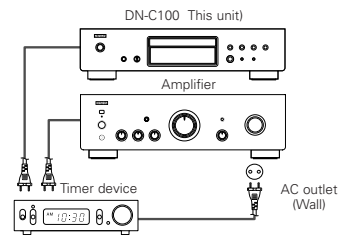

1 Turn on the power of the connected components.

2 Switch the amplifier's input function to the function to which the player is connected.

3 Load a disc in the player.

4 Set the audio timer for the desired times.

5 Turn the timer "ON".

- The power of the components connected to the timer turns off.

※ When the set time is reached, the power of the different components automatically turns on and playback starts from the first track.

Others

Troubleshooting

If a problem should arise, first check the following:

1. Are the connections correct ?

2. Have you operated the player according to the Operating Instructions ?

If this unit is not operating properly, check the items listed in the table below. Should the problem persist, there may be a malfunction. Disconnect the power immediately and contact your store of purchase.

Symptom	Measures	Cause	Page
Disc tray does not open.	• The power is not on.	• Turn on the power.	7
"NO DISC" is displayed even though a disc is loaded.	• The disc is not properly loaded.	• Reload the disc.	2, 3
"00 00 : 00" is displayed even though a disc is loaded.	• The loaded disc is not a CD.	• Load a CD.	2
Disc is not played when play button is pressed.	• The disc is dirty or scratched.	• Wipe the dirt off the disc or replace the disc.	3
No sound is produced or sound is distorted.	• The output cables are not properly connected to the amplifier. • The amplifier's function setting or adjustments are not right.	• Check the connections. • Check the amplifier's function and controls and adjust as necessary.	6 -
No digital signals are output.	• The connection cables are not properly connected.	• Check the connections.	6
Specific section of the disc cannot be played properly.	• The disc is dirty or scratched.	• Wipe the dirt off the disc or replace the disc.	3
Pogrammed playback is not possible.	• The tracks have not been pogrammed properly.	• P ogram properly.	8
A CD-R or CD-RW disc cannot be played.	• The disc has not been finalized. • The recording conditions are bad or the quality of the disc itself is poor.	• Finalize the disc then play it. • Use a properly recorded disc.	2 2
Set does not operate properly when remote control unit is operated.	• The batteries are spent. • The remote control unit is too far from the set.	• Replace the batteries with new ones. • Move the remote control unit closer to the set.	3 3

Specifications

□ Audio performance

• Analog output	
Channels:	2 channels
Playable frequency range:	2 Hz ~ 20 kHz
S/N:	105 dB
Dynamic range:	98 dB
Harmonic distortion:	0.003 % (1 kHz)
Wow & flutter:	Below measurable limits
Output level:	2.0 V (10 kΩ/kohms)
Signal type:	16 bit linear PCM
Sampling frequency:	44.1 kHz
Usable discs:	Compact Disc
• Digital output	
Optical:	-15 ~ -21 dBm
Emission wavelength:	660 nm

□ General

Power supply:	AC 230 V, 50 Hz
Power consumption:	13 W
Maximum external dimensions:	434 (W) x 107 (H) x 279 (D) mm (including protruding parts)
Mass:	4.0 kg

□ Remote control unit (RC-1028)

Remote control type:	Infrared pulse
Batteries:	R03/AAA Type (two batteries)
External dimensions:	49 (W) x 220 (H) x 21 (D) mm
Mass:	106 g (included batteries)

* For purposes of improvement, specifications and design are subject to change without notice.

D&M Holdings Inc.
PROFESSIONAL BUSINESS COMPANY
TOKYO, JAPAN
<http://www.dm-pro.jp>

Printed in China 00D 511 4561 003