

Fender[®]

THE SOUND THAT CREATES LEGENDS

The
Twin Amp

Owner's Manual

TYPE: PR266

P/N 047775

Introduction

The Fender TWIN™ is the next step up in the evolution of High Performance instrument amplification. The new TWIN is a direct descendent of classic tube amps such as the Fender Twin Reverb®, and 410 Bassman®, which have shaped today's world of guitar amps.

The features of the new Fender TWIN provide flexibility rarely found in tube amplifiers. Channel One is the traditional Fender design which offers the vintage sound as well as contemporary sounds with the use of switch-selectable Gain and Master Volume controls. Channel Two is like owning a second, modern hot-rodged amp with more soaring gain than previously found in a Fender tube amp. The CLASSIC Fender tube reverb sound is there too and is switch assignable to Channel One, Channel Two, or both. Finally, a master PRESENCE control allows you to "dial-in" just the right amount of high-end sparkle.

Special effects will interface to the Effects Loop easily and with no guesswork on levels. Simply set the three position LEVEL SELECT switch to match up to the latest rack-mount digital processor or your old favorite battery powered effect pedals. The effects MIX control is used for blending the effect (wet) sound with the normal (dry) guitar sound. Depending on the effects device used, the effects MIX control, when set to "10", will produce the "wet" sound only. A three position switch is provided for assigning the Effects Loop to Channel A, Channel B, or both. In addition, the PREAMP OUT & POWER AMP IN jacks can be used as a second effects loop, or as Send and Return points while slaving amps together. The possibilities are endless (e.g., by inserting a Chorus pedal between the PREAMP OUT of an amp and the POWER AMP IN of another, a true stereo image effect can be achieved).

The power amplifier section of the TWIN is a 100 Watt Fender

design which has become the industry standard as a result of its time worn reputation for reliability and good sound; however, this amplifier goes further than its clones. In addition to a HIGH/LOW POWER switch, that you can hear, the TWIN also features external bias and balance adjustment capability. The four 6L6WGC/5881 output tubes can be set up by anyone with a digital voltmeter without removing the chassis. This means that you can re-bias every time you re-tube and can check bias and balance over the life of the tubes. With the price of tubes today you can't afford not to have them set up right every time. In addition to being able to drive a wide range of speaker combinations from the three speaker output jacks, switch selectable to 4, 8, or 16 ohms, the BALANCED LINE OUTPUT will drive any 600 ohm line input. This is a transformer coupled, truly balanced, floating ground output which is particularly useful for driving slave power amps or, with the proper equalization, as a send to a mixing console for recording or sound reinforcement.

The Fender TWIN features two Fender Special Design 12" speakers which have been specifically tailored to reliably produce the legendary Twin Reverb sound.

The selection of a Fender amplifier will reward you with years of quality music in a wide range of controlled sounds. This manual is designed to familiarize you with the equipment and to acquaint you with its many fine features. Please read it carefully so that you will benefit from the many features as soon as you start using the amplifier.

The built-in quality of a Fender amplifier is the result of over four decades of dedication in the combined skills of research and development by our engineers and musicians.

That is why we proudly say...

FENDER, The Sound That Creates Legends.

Twin Amp Sound Settings

Note: These settings are suggested starting points. Your settings may vary due to your guitar, venue, or most importantly...personal taste!

Dirty Rhythm / Strat, Any Pickup

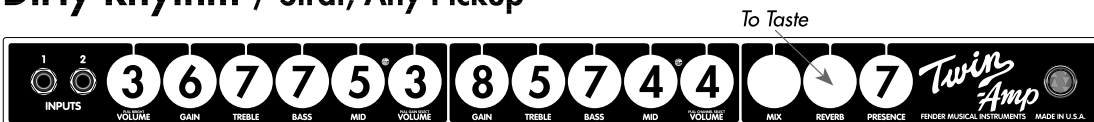

Stratocaster Blues w/ The Twin's Output Switch Set To "Low".

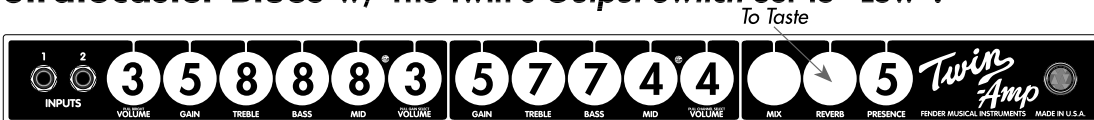

Tele - Twang / Any Pickup

Pull Bright

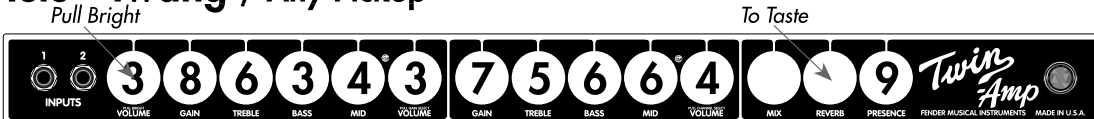

Rockin' Bridge Humbucker

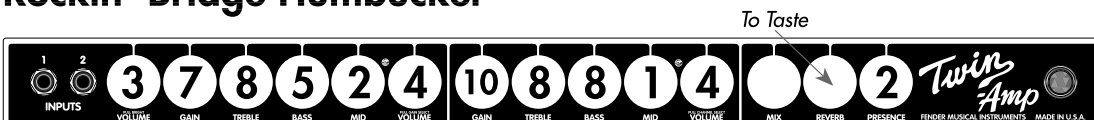

Twin Front Panel Functions (Fig. 1)

A. INPUT 1 — A high impedance, high sensitivity plug-in connection for instruments.

B. INPUT 2 — A plug-in connection for instruments. This input exhibits less input impedance and sensitivity than INPUT 1, making it useful for guitars that have active pickups. This input will provide a darker tone if used with guitars that have passive pickups.

Note: INPUT 1 and INPUT 2 are inputs for both Channel One and Channel Two.

C. VOLUME — Adjusts the overall volume of the Channel One Clean Sound.

D. PULL BRIGHT — This pull switch on the Clean Sound VOLUME control (item C) boosts the highs. This has the sonic effect of adding high end “sparkle” (to the Clean Sound only).

E. GAIN — Adjusts the gain for the Channel One Vintage Drive Sound. Lower settings provide an “on-the-edge” clean sound, while higher settings provide gradual compression, like a “cranked” vintage amp, but at controllable volumes. This control works in conjunction with the Channel One Vintage Drive Sound VOLUME control (item J) to set the overall volume of the Channel One Vintage Drive Sound.

F. TREBLE — Adjusts the amount of boost or cut in the high frequency range of Channel One.

G. BASS — Adjusts the amount of boost or cut in the low frequency range of Channel One.

F. MID — Adjusts the amount of boost or cut in the middle frequency range of Channel One.

I. VINTAGE DRIVE INDICATOR — When lit, this yellow LED indicates that the Channel One Vintage Drive Sound is selected, and that the Channel One Vintage Drive Sound GAIN (item E) and VOLUME (item J) controls are active.

J. VOLUME — Adjusts the overall volume of the Channel One Vintage Drive Sound.

K. PULL GAIN SELECT — When this pull switch on the Vintage Drive Sound VOLUME control (item J) is in the “in” position, the Channel One Clean Sound is selected and the Clean Sound VOLUME control (item C) is active; when in the “out” position, the Vintage Drive Sound is selected, and the Channel One Vintage Drive Sound GAIN (item E) and VOLUME (item J) controls are active. This pull switch is overridden when the footswitch is connected.

L. GAIN — Adjusts the amount of gain in Channel Two. Lower settings provide gradual compression, while higher settings provide more sustain... lots more sustain.

M. TREBLE — Adjusts the amount of boost or cut in the high frequency range of Channel Two.

N. BASS — Adjusts the amount of boost or cut in the low frequency range of Channel Two.

O. MID — Adjusts the amount of boost or cut in the middle frequency range of Channel Two.

P. CHANNEL TWO INDICATOR — When this red LED is lit, Channel Two is selected, and the Channel Two GAIN (item L) and VOLUME (item Q) controls are active.

Q. VOLUME — Adjusts the overall volume of Channel Two. As this control is rotated clockwise from the “1” position, the volume comes up slowly at first for additional control at lower listening levels; but near mid volume settings, the volume comes up faster for performance levels.

R. PULL CHANNEL SELECT — When this pull switch on the Channel Two VOLUME control (item Q) is in the “in” position, Channel One is selected. When it is in the “out” position, Channel Two is selected. This pull switch is overridden when the footswitch is connected.

S. MIX — Adjusts the amount of audible “wet” (processed) signal when the variable level effects loop (located on the back panel) is used. When the MIX control is in the full counter-clockwise position (“1”), the “wet” signal will not be audible. When the MIX control is in the full clockwise position (“10”), only the “wet” signal will be heard (depending on the type of effect used). When nothing is plugged into the EFFECTS RETURN jack (located on the rear panel), the MIX control will have no effect on the sound. Also see the “EFFECTS SELECT” switch in the Twin Rear Panel Functions section of this manual.

T. REVERB — Adjusts the amount of reverb present in Channel One and Channel Two. When the footswitch is connected, the reverb can be turned on and off remotely. Also see the “REVERB SELECT SWITCH” in the “Twin Amp Rear Panel Functions” section of this manual.

U. PRESENCE — This is a true vintage-style PRESENCE control that affects the way the power amplifier responds to upper high frequencies. As the control is turned clockwise, the power amplifier (in interaction with the speaker load) enhances upper highs, giving the Twin’s overall sound a “sparkling” quality.

V. PILOT LAMP — When this lamp is illuminated, the amplifier is receiving power. Should the lamp burn out, turn off the amplifier and unplug it from its power source, unscrew the red jewel, and replace the lamp with type T47 light bulb.

Twin Rear Panel Functions (Fig. 2)

A. FUSE — The fuse is in the AC supply of the amplifier and will protect the amplifier and the operator in the event of an electrical fault.

Fig. 1

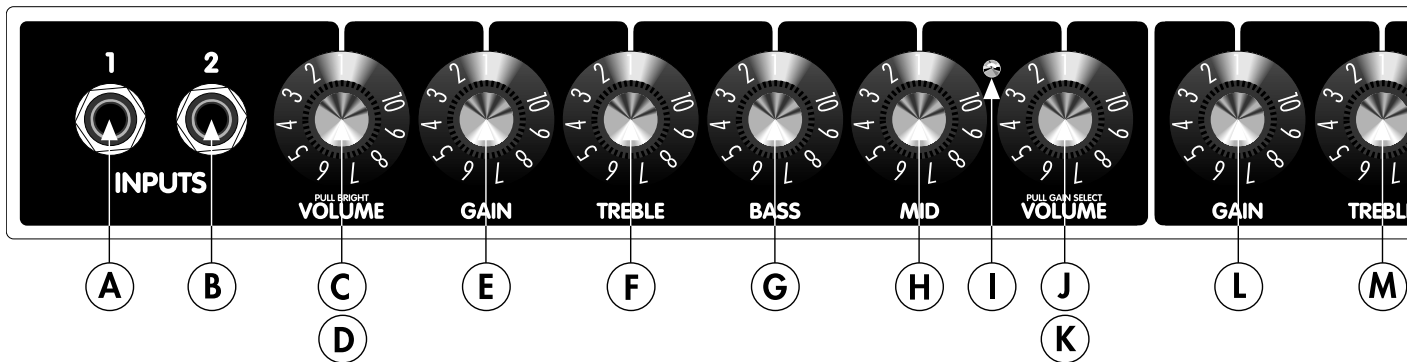
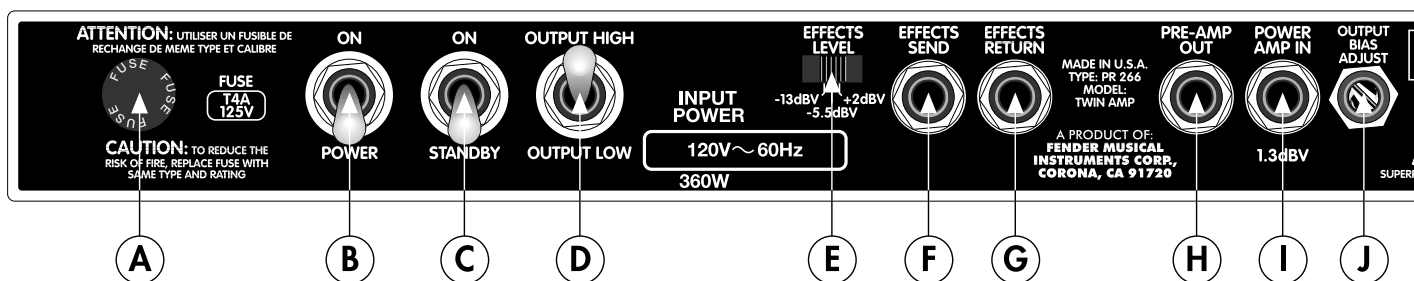

Fig. 2



If a fuse blows, it should be replaced only with a fuse in accordance with the listing at the fuse holder. If the amplifier repeatedly blows fuses, it should be checked out by a qualified technician. UNDER NO CIRCUMSTANCES should a fuse of a different type or higher rating, or a fuse bypass be used, as this could damage the equipment and present a serious safety hazard.

B. POWER SWITCH — This switch turns the AC power on and off. When the switch is off (down), the amplifier is completely shut down.

C. STANDBY SWITCH — When in the STANDBY position, the amplifier is off; however, the tube filaments are left on as to eliminate warm-up time, provided that the POWER SWITCH (item B) is ON. Use of this feature during short breaks versus using the POWER SWITCH will increase tube life.

D. OUTPUT SWITCH — When in the OUTPUT HIGH position, the maximum output power of the Twin is set to 100 watts RMS, when in the OUTPUT LOW position, 25 watts RMS. The OUTPUT HIGH position is normally used in most applications, and the OUTPUT LOW position is useful for simulating a smaller amplifier, especially when the power amp is overdriven.

E. EFFECTS LEVEL — This switch directly affects the signal level appearing at the EFFECTS SEND JACK (item F) by boosting or attenuating the signal being sent to the effects. External rack effects usually require a setting of 3dBV. Use the highest setting possible that does not produce distortion for the best low noise performance.

F. EFFECTS SEND JACK — Provides an unbalanced output signal from the preamp, pre-reverb. It is used to patch into effects.

G. EFFECTS RETURN JACK — This jack provides a pre-reverb return from effects gear. Plugging into this jack makes the MIX control on the front panel active.

H. PRE-AMP OUT JACK — The PRE-AMP OUT JACK, in conjunction with the POWER AMP IN JACK (item I), provides a post-reverb patch point at the power amplifier input. This jack can be used to provide an unbalanced, line-level signal (1.3dBV) for recording and sound reinforcement consoles, and for driving external power amplifiers, or another TWIN used as a slave amp. To use another TWIN as a slave amp, simply run a guitar cord from the master TWIN'S PRE-AMP OUT JACK to the slave TWIN'S POWER AMP IN JACK. (Note: this output is best for driving tube type slave amps. See item P, BALANCED LINE OUT, for driving solid-state slave amps.)

I. POWER AMP IN JACK — This jack connects directly to the input of the power amplifier. It automatically disconnects the preamp signal when used. This is useful for using the Twin as a slave amp.

J. OUTPUT BIAS ADJUST — This trim adjustment is used in conjunction with the OUTPUT BALANCE ADJUST (item L) and the BIAS TEST POINTS (item K) to set the output tube bias. See Output Tube Bias Adjustment Instructions below.

K. BIAS TEST POINTS — Used to measure output tube bias and balance with a digital voltmeter. See Output Tube Bias Adjustment Instructions below.

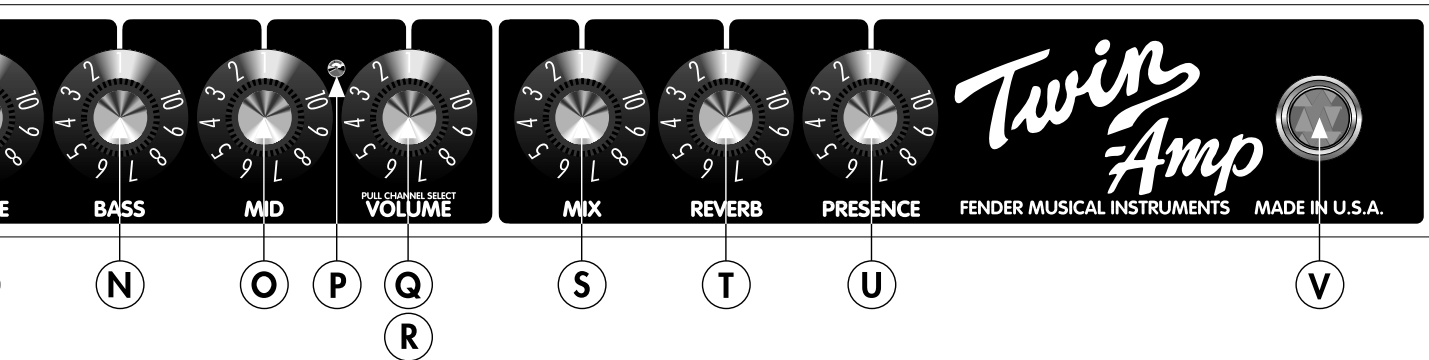

N O P Q S T U V

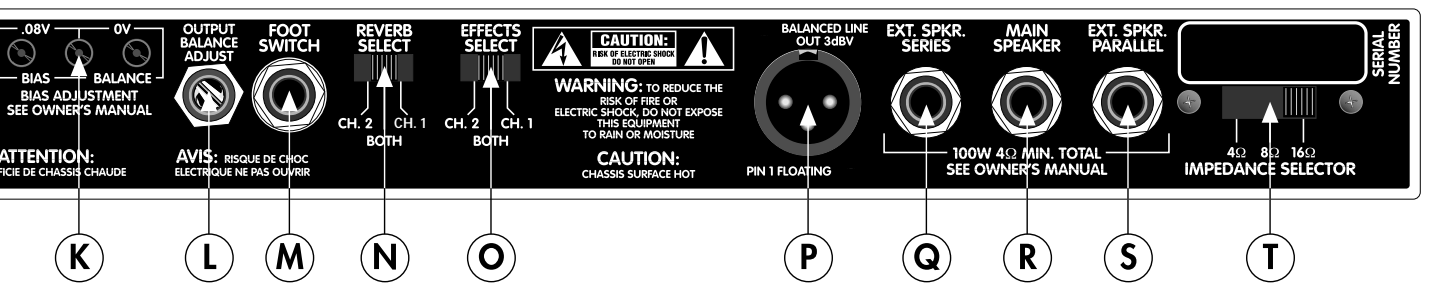

K L M N O P Q R S T

L. OUTPUT BALANCE ADJUST — Used in conjunction with the BIAS TEST POINTS (item K) to set the balance between the push/pull tube sections of the power amp. See output Tube Bias Adjustment Instructions below.

Output Tube Bias Adjustment Instructions —

1. Turn on the amplifier and let it warm up for at least two minutes with the STANDBY SWITCH (item C) in the ON position and the OUTPUT SWITCH (item D) in the OUTPUT HIGH position.
2. With a digital voltmeter set to its most sensitive DC voltage scale, measure the voltage between the two BIAS TEST POINTS (item K) labeled "BIAS" and adjust the OUTPUT BIAS ADJUST control (item L) for a reading of .08 VDC (80 mVDC).
3. Connect the digital voltmeter to the two BIAS TEST POINTS (item K) labeled "BALANCE" and adjust the OUTPUT BALANCE ADJUST control (item L) for 0 VDC.

Notes:

1. Make bias and balance adjustments only when necessary. If you are unsure about setting bias and balance, it is best to LEAVE THIS FEATURE ALONE, as it is pre-set at the factory.
2. For optimum sonic performance, set bias to .08 VDC, then set balance.
3. For optimum sonic performance with increased tube life, set bias to .06 VDC, then set balance.
4. For optimum tube life, set bias to .04 VDC, then set balance. If a bias measurement of .04 VDC cannot be obtained, replace the 6L6GC output tubes.
5. If the output tubes can't be balanced, check the bias setting and/or replace the 6L6GC output tubes.

M. FOOTSWITCH JACK — Plug-in connection for the remote

footswitch. The footswitch GAIN SELECT button switches between the Channel One Clean and Vintage Drive sounds, the CHANNEL SELECT button switches between Channel One and Channel Two, and the REVERB button turns the reverb on and off. Note: Any good patch cord will work with the remote footswitch; however, a speaker grade cord, when it's available, is preferable to a coax guitar cord. When the footswitch is connected, it overrides the front panel PULL GAIN SELECT and PULL CHANNEL SELECT switches.

N. REVERB SELECT SWITCH — This three position switch assigns the reverb to Channel One, Channel Two, or to both channels. For example, if the switch is set to "CH. 1", reverb will be available for Channel One ONLY. This switch is used in conjunction with the front panel REVERB control and the reverb on/off footswitch button.

O. EFFECTS SELECT SWITCH — This three position switch assigns the EFFECTS RETURN JACK (item G) to Channel One, Channel Two, or to both channels. For example, if the EFFECTS SEND and EFFECTS RETURN jacks are being used to patch in an effect, and the EFFECTS SELECT SWITCH is set to the "CH. 1" position, the effect will be heard ONLY when Channel One is selected.

P. BALANCED LINE OUT — This XLR jack provides a transformer coupled, balanced, floating ground output which can be used to drive slave power amps, or with proper equalization, used as a send to a mixing console for recording or sound reinforcement.

For optimum performance when driving slave amps, use high power solid-state amplifiers of 300 watts minimum rating, and set the gain

of the slave amps such that they NEVER clip with full output from the Twin. Here's why: Since the signal at the BALANCED LINE OUT is derived directly from the output transformer, the signal is a replica of the voltage present at the speakers in the Twin. If the output of the slave amps never clip, then the voltage at the output of the slave amps will also be a replica of that on the speakers in the Twin. This will preserve the Twin sound. As for the 300 watt minimum rating...

In order for a "slaved" solid-state amp to reproduce the sound of a tube master amp, a solid-state amp needs lots of headroom. For example, because of the way a tube amp interacts with a speaker load, a 20 watt tube amp, when driven into heavy clipping, can produce output signals equivalent to a 180 watt solid-state amplifier. This nine-to-one ratio can get excessive when a 100 watt tube master amp is used. But, if the solid-state slave amp has enough headroom to never clip, and if the speakers used on the slave amp are the same as those used in the Twin, voila! You now have the capability of obtaining large amounts of on-stage Twin sound. We recommend using a Fender Electronics SPL9000(s) with an additional Fender speaker enclosure(s).

If the BALANCED LINE OUT is used as a send to a mixing console, it should normally be pre-equalized before going to the console input. What works well is to run the BALANCED LINE OUT signal through a low-pass filter set to 5 to 6 kHz. The slope of the filter needs to be steep, 18 dB per octave minimum. A handy way to do this is to use the low-pass output of an active crossover, or to use a parametric equalizer. By tweaking the equalization, some very useful sounds can be obtained.

Q. EXT. SERIES JACK — Plug-in connection for extension speakers. This should be used in conjunction with the MAIN SPEAKER jack (item R). By using the EXT. SERIES JACK, the extension speaker is placed in series with the main speaker; therefore, the impedance of the extension speaker adds to that of the main speaker. For example, by connecting a 4 ohm speaker to each jack, the total load is $4+4=8$ ohms. The IMPEDANCE SELECTOR switch (item T) would then be set to 8 ohms. (Note: an additional 8 ohm speaker could be added to the EXT. PARALLEL JACK (item S) for a total of 4 ohms, with the IMPEDANCE SWITCH set accordingly.)

R. MAIN SPEAKER JACK — Plug-in connection for speakers. For proper operation, this jack should always be used first as connection to the primary speaker(s). If this jack is used alone, set the IMPEDANCE SELECTOR switch (item T) to equal the total speaker load impedance connected to it.

S. EXT. PARALLEL JACK — Plug-in connection for extension speakers. This jack should be used in conjunction with the MAIN SPEAKER JACK (item R). By using the EXT. PARALLEL JACK, the extension speaker will be placed in parallel with the main speaker; therefore, reducing the total load impedance. For example, by connection a 16 ohm speaker to the MAIN SPEAKER JACK and a 16 ohm speaker to the EXT. PARALLEL JACK, the total impedance will be $(16 \times 16) / (16 + 16) = 8$ ohms. The IMPEDANCE SELECTOR SWITCH (item T) would then be set to 8 ohms. (Note: An additional 8 ohm speaker could be connected to the EXT. SERIES SPEAKER JACK (item Q) for a total load of 16 ohms, with the IMPEDANCE SWITCH set accordingly.)

T. IMPEDANCE SELECTOR SWITCH — Sets the output impedance of the amplifier. The setting should equal the total load impedance as determined above using the three speaker jacks. (The Twin is supplied with two 8-ohm speakers connected in series; therefore, the IMPEDANCE SELECTOR SWITCH is set to 16 ohms at the factory.)

LOW POWER OPTION

The Fender Twin can be run with only two output tubes instead of four. This is done by removing the inner two 6L6GC tubes (the 2nd and 3rd large tubes, counting left to right), and setting the IMPEDANCE SELECTOR SWITCH to one-half of the total speaker load; e.g., with a total speaker load of 16 ohms connected, the OUTPUT IMPEDANCE SWITCH should be set to 8 ohms. (Remember — half the tubes, half the impedance.) This will produce 60 watts RMS in the OUTPUT HIGH setting, and 15 watts RMS in the OUTPUT LOW setting.

LINE CORD

Your amplifier is equipped with a grounding type supply cord to reduce the possibility of shock hazard. Be sure to connect it to a grounded AC receptacle. DO NOT ALTER THE AC PLUG.

TUBES

The Fender Twin tube complement consists of four Fender Special Design 6L6WGC/5881's (part number 039214), three Fender Special Design 12AT7's (part number 023531), and five 12AX7A's (part number 013341). Fender's Special Design Tubes provide optimum performance in the amplifier. For best results, replace with Fender original equipment tubes only. Tube location table is in cabinet.

BLACK TOLEX COVERING CARE

The exclusive Fender Tolex covering on your cabinet is especially designed to provide years of lasting beauty. A very light soapy solution on a sponge may be used to remove dirt and residue that may accumulate in the grain. Be careful not to let any liquid come in contact with the operating surfaces. DO NOT have the amplifier plugged into a power outlet when cleaning.

TROUBLESHOOTER'S CHECKLIST

- Is the power cord properly plugged into an electrical outlet?
 - Is there power at the outlet?
 - Is the fuse blown?
 - Is the speaker(s) properly connected to the amplifier?
 - Is the amp on standby?
 - Are all the control knobs turned up above "4"?
 - Is the volume control on the instrument turned up?
 - Is the instrument plugged into the amplifier?
- (Eliminate any effects devices and try another cord.)

If, after checking all of the above, the system is still not operating properly, consult your authorized Fender Service Dealer.

Twin Block Diagram

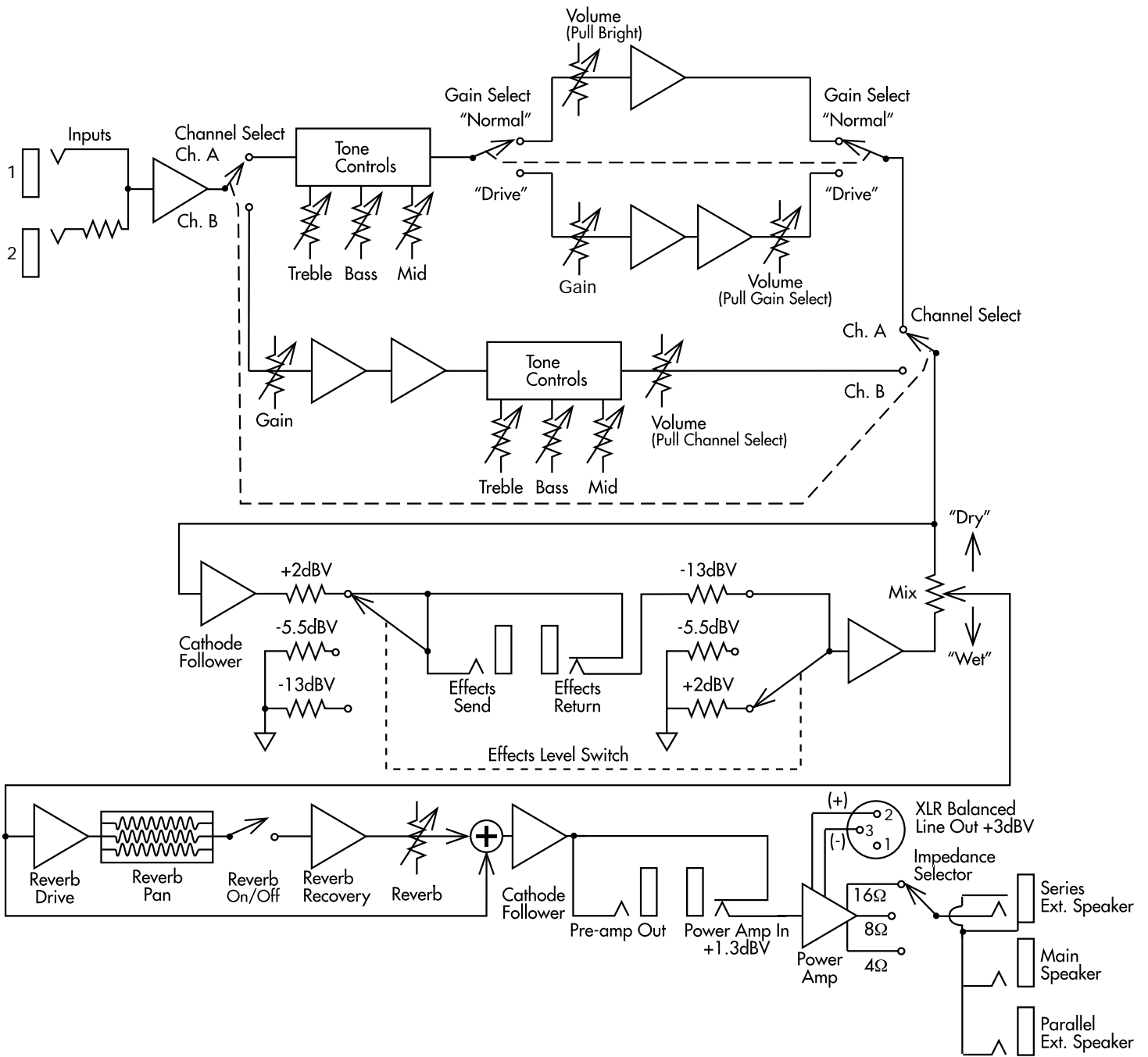

Specifications

PART NUMBER:	120V version: 21-4809 230V version: 21-4889
TYPE:	PR 266
DIMENSIONS:	Height: 20-3/4" (52.7 cm) Width: 26-3/8" (67 cm) Depth: 11-1/2" (29.2 cm) Weight: 77 lbs. (35 kg)
POWER REQUIREMENT:	120V version: 120 volts AC, 60 Hz, 360 watts. 230V version: 230 volts AC, 50 Hz, 360 watts.
FUSE TYPE:	100V and 120V versions: 4A SLO-BLO, 125V min. 230V and 240V versions: T2A, 250V.
INPUT IMPEDANCE:	Input 1: 1M ohm. Input 2: 136k ohm.
EFFECTS LOOP:	Pre reverb. Nominal level: +2, -5.5, -13 dBV. Output impedance: 4.2k ohm maximum. Input impedance: 130k ohm minimum.
EFFECTS MIX CONTROL:	Continuously variable between the signal at the EFFECTS SEND and EFFECTS RETURN jacks.
REVERB:	Post effects loop.
PRE-AMP OUT:	Post reverb, +1.3 dBV nominal level. Recommended load: 22k ohm minimum.
POWER AMP IN:	+1.3 dBV sensitivity, 130k ohm input impedance.
BALANCE LINE OUTPUT:	Derived from the output transformer, fully balanced. +3 dBV nominal level into 600 ohms or greater. Pin 1 floating, pin 2 (+), pin 3 (-).
AMPLIFIER LOAD IMPEDANCE:	Switch selectable for 4, 8, or 16 ohms.
POWER OUTPUT: into 4, 8 or 16 ohms.	OUTPUT HIGH setting: 100 watts RMS, 5% THD. OUTPUT LOW setting: 25 watts RMS, 5% THD.
SPEAKER COMPLEMENT:	Two Fender P/N 026488 Special Design 12" 8 ohm speakers wired in series.

A PRODUCT OF:
FENDER MUSICAL INSTRUMENTS CORP.,
CORONA, CA 91720
MADE IN U.S.A.