

# ULTIMATE CHORUS

## SERVICE MANUAL



### CONTENTS:

- Notices
- Specifications
- Parts lists:
  - PCB assembly
  - Chassis assembly
  - Cabinet assembly
  - Footswitch assembly
  - Miscellaneous
- Schematics/diagrams

Fender Musical Instruments Corp. 7975 North Hayden Road Scottsdale, AZ 85258

# ULTIMATE CHORUS

(This is the model name for warranty claims)

## SERVICE MANUAL

JUNE 1995

### IMPORTANT NOTICE:

The information contained herein is CONFIDENTIAL and PROPRIETARY to Fender Musical Instruments Corp. It is disclosed solely for use by qualified technicians for purposes of equipment maintenance and service. It is not to be disclosed to others without the expressed permission of Fender Musical Instruments Co. All specifications subject to change without notice.

For warranty repair service, only Fender specified part numbers are to be used. It is recommended they also be used for post-warranty maintenance and repair.

Parts marked with an asterisk (\*) indicate the required use of that specific part. This is necessary for RELIABILITY and SAFETY requirements. **DO NOT USE A SUBSTITUTE!**

A coded naming convention is used in the description of certain parts. The codes and what they mean are as follows:

#### CAPACITOR CODES

CAP AE = Aluminum Electrolytic  
CAP CA = Ceramic Axial  
CAP CD = Ceramic Disk  
CAP MPF = Metalized Polyester Film  
CAP MY = Mylar  
CAP PFF = Polyester Film/Foil

#### RESISTOR CODES

RES CC = Carbon Comp  
RES CF = Carbon Film  
RES FP = Flame Proof  
RES MF = Metal Film  
RES WW = Wire Wound

#### HARDWARE CODES

BLX = Black Oxide  
CR = Chrome Plated  
HWH = Hex Washer Head  
M = Machine Screw  
NI = Nickel Plated  
OHP = Oval Head Phillips  
PB = Particle Board  
PHP = Pan Head Phillips  
PHPS = Pan Head Phillips Sems  
SMA = Sheet Metal "A" Point  
SMB = Sheet Metal "B" Point  
SS = Stainless Steel  
TF = Thread Forming  
ZI = Zinc Plated

# ULTIMATE CHORUS

## SPECIFICATIONS

<b>Product Release No.:</b>	PR 204 <i>(This is not a model number)</i>	
<b>Input Impedance:</b>	Greater than 1M Ohm	
<b>Nominal Level:</b>	100mV	
<b>Power output:</b>	65 Watts RMS @ 5% T.H.D. per channel = 130 Watts RMS	
<b>Rated Load Impedance:</b>	8 ohms per channel	
<b>Mono Effects Loop:</b>	Output impedance:	1k $\Omega$
	Input impedance:	25k $\Omega$
	Nominal level:	-10dBV
<b>Stereo Effects Loop:</b>	Nominal Level:	-10dBV
	Output Impedance:	1k Ohms
	Input Impedance:	94k Ohms
	Specifications for each channel – Left on Tip, Right on Ring	
<b>Dimensions:</b>	Height: 18 1/2"	(47.0 cm)
	Width: 26 1/8"	(66.0 cm)
	Depth: 10 1/4"	(26.0 cm)
<b>Weight:</b>	47 lbs.	(21.3 kg)

*Product specifications are subject to change without notice*

## THEORY OF OPERATION

### **NORMAL CHANNEL**

The first stage (U1A) sets up the initial response of the amplifier. It provides a second order high-pass filter with a 3dB down point of 60 Hz, and a gain of about 4. The output of U1A splits to feed the NORMAL and DRIVE channels. For the NORMAL channel, the signal feeds through the NORMAL VOLUME control (R11) to U1B. The output of U1B drives through the tone controls and feeds summing amplifier U4A.

### **DRIVE CHANNEL**

*The signal from U1A feeds a special tone-shaping circuit which optimizes the frequency response for the distortion circuit that follows. U2A provides the variable gain adjustment that drives the distortion circuit. It also acts as a bandpass filter with 3db down points at 90Hz and 4kHz. JFET Q2 mutes the input to the distortion circuit when in the NORMAL channel mode. Diodes CR4 and CR5 are used as a voltage clamp to prevent excessive voltage from damaging the JFET. U2b is the distortion circuit. The signal couples to*

# ULTIMATE CHORUS

## THEORY OF OPERATION (CONT)

U3A, which contains a tone shaping circuit that enhances the distortion characteristics. The signal is then fed to the PRESENCE control, DRIVE VOLUME control, and to U3B. U3B drives the tone controls, and feeds the signal through JFET Q3 to summing amplifier U3A.

### **REVERB AND EFFECTS LOOP**

The output from U4A splits to feed U4B and the reverb drive circuit U5B. U5A senses the return signal from the reverb pan and feeds the NORMAL REVERB (R60) and DRIVE REVERB (R63) controls. When switching between channels, JFETs Q4 and Q5 select the reverb signal from the respective reverb control pot. This allows different levels of reverb for each channel. The reverb signal and dry signal are summed at U4B. The output from U4B drives the MONO EFFECTS SEND jack (J3), is normalled to the MONO EFFECTS RETURN jack (J4) then splits to feed the chorus and stereo circuitry. U7A represents the left channel, and U7B the right channel. The output signals from U7A & U7B drive the STEREO EFFECTS SEND jack (J5), and are normalled to the STEREO EFFECTS RETURN jack (J6), and feed the left and right power amplifiers.

### **CHORUS**

The input signal to the Chorus circuit is capacitively coupled to U6B, which drives the Bucket Brigade Device (BBD) U13. Trimpot R75 set the DC bias for U6B and U6A. When properly adjusted, the output from U6A will display symmetrical clipping. (Refer to the adjustment procedure on the service diagram). The BBD is clocked by U12 at 180kHz.

The 180kHz carrier clock is Frequency Modulated by the Low Frequency Oscillator (U11), which deviates the carrier at maximum DEPTH from 60kHz to 300kHz. The RATE of deviation runs from about 0.3Hz to 8.7Hz. The FM deviation on top of the BBD delay results in a pleasing choral effect.

C39 and R72 (@U6B) provide pre-emphasis above 7kHz. At the output of U6A, R84 and C47 provide the de-emphasis. This helps to reduce noise. C43, C44, and C46 filter out clock noise. The Dry or Chorus signal is selected by JFETs Q6 and Q7, buffered by U7b, and fed through the STEREO EFFECTS LOOP to the right channel power amplifier.

### **CHANNEL, CHORUS, AND REVERB SWITCHING**

The A.C. voltage from the power transformer secondary is tapped off through resistor R134, and presented to the footswitch jack (Approx. 20 V RMS). By rectifying the positive or negative side of the waveform, a D.C. control voltage is created and sensed by comparators U10A and U10B. Diode's CR57 and CR59 set up the reference voltages at the non-inverting inputs of the comparators. Therefore the control voltage (@ inverting inputs) must toggle above and below the reference voltage to cause the output of the comparator to toggle between +15Vdc and -15Vdc. The output of comparator U10A controls the indicator LEDs and JFETs Q1 through Q5. JFETs Q1 and Q3 select the output of either the NORMAL or DRIVE channel. When the CLEAN channel is active, JFET Q2 mutes the signal that feeds the input of the DRIVE channel. This prevents crosstalk. JFETs Q4 and Q5 select the reverb return signal through the NORMAL REVERB or DRIVE REVERB controls. This allows different levels of reverb for the NORMAL and DRIVE channels.

The output of U10B provides a control voltage to the following three sections of the Chorus circuit:

- The base of transistor Q13, which enables the Chorus indicator LED.

- The Low Frequency Oscillator U11.

- JFETs Q6 and Q7, which determine if the dry or chorus signal is fed to U7B.

### **INHIBIT/MUTING**

The inhibit circuit provides two functions. First, without a guitar cable plugged into the input jacks, all of the JFETs will mute their respective signal paths. Channel switching will not operate. The muting will be disabled when a cable is inserted at the input jacks. Secondly, if a guitar cable is connected to one of the input jacks, and then the power is switched on, the muting circuit will be disabled after a short delay (about

# ULTIMATE CHORUS

## THEORY OF OPERATION (CONT)

1 second) set up by R139 and C73. This allows time for the circuitry to stabilize, which prevents turn-on pops and snaps.

The inhibit switches are located within the input jacks. The control voltage through CR55 to U10A locks the unit in the DRIVE channel mode, muting the NORMAL channel and NORMAL REVERB. At the same time, the inhibit voltage mutes the DRIVE channel and DRIVE REVERB. AT JFET Q6, the Chorus output has it's own turn-on delay circuit. If the Chorus button is engaged before power-up, R88 and C49 will provide a delayed turn-on for the Chorus. Again to prevent pops and snaps.

**POWER AMPLIFIERS** (The following reference designators apply to the Left amplifier)  
 U8 (MC1436) is a high-voltage op-amp that provides voltage gain for the power amplifier. CR28 and CR29 act as differential protection diodes that prevent the positive and negative inputs of U8 from becoming more than 0.6 volts apart. Bootstrap Capacitors C59 and C60 sense the output through R107. This provides more voltage swing for the opamp with respect to ground.

Diodes' CR30-CR33 (BYV26D) make up the Fixed-Bias circuit for the output transistors. The Bias Diodes mount through a hole in the transistor heatsink. This ensures the Diodes will properly track the temperature of the output transistors. These Diodes were selected because they exhibit a 2mV decrease in Knee Voltage for every 1 degree (Celsius) increase in temperature. Pin 6 of U8 is at 0Vdc. Therefore the Bias Diodes provide 2 voltage drops (+/-1.2volts) to the Base of Darlington Transistors Q8 and Q9.

**TROUBLESHOOTING TIP:** With the circuit board removed, the heatsinking for the output transistors is greatly reduced. With no signal applied, the Bias/Idle current will cause the output transistors to quickly overheat. Use a jumper wire to short across the bias diodes. The easiest way is to jumper from the bases of opposing output transistors. This will turn off the transistors.

Diodes' CR34-CR37 make up a voltage clamp protection circuit. IF the bases of the output transistors reach 4.5 volts with respect to the output, the diodes will turn on, clamping the bases of the output transistors. The power amplifiers each provide 63 watts at 5% THD into a single 8 ohm speaker.

## PARTS LIST

### PRINTED CIRCUIT BOARD ASSEMBLY

QTY	PART #	DESCRIPTION	REFERENCE DESIGNATION
1	039246	PCB ASY "ULTIMATE CHORUS" ALL VOLTS	(STUFFED)
1	031910	BREAKER THERMAL 15A 155/195 DEG F	TS1
3	028104	BUTTON PUSH SWITCH BLACK	(@ S1,2,3)
1	028577	CABLE ASSY REVERB 30"	(REVERB CABLE)
6	038689	CAP AE AX 100V .47uF 20%	C14,16,29,32,38,48
4	038690	CAP AE AX 100V 1uF 20%	C49,73,80,83
7	026517	CAP AE AX 50V 2.2uF 20%	C37,55,56,58,64,65,67
2	038691	CAP AE AX 50V 4.7uF 20%	C57,66
2	038692	CAP AE AX 35V 10uF 20%	C3,4
10	025960	CAP AE AX 16V 22uF 20%	C5,30,36,42,51,53,61,62,70,71
1	038693	CAP AE AX 50V 47uF 20%	C78
4	028471	CAP AE RDL 50V 47uF 20%	C59,60,68,69
2	028474	CAP AE RDL 25V 100uF 20%	C88,89
1	028479	CAP AE RDL 25V 220iF 20%	C41
2	031756	CAP AE RDL 50V 4700uF	C84,85
2	038873	CAP CA 100V 22pF 5%	C28,82
3	038698	CAP CA 100V 47pF 5%	C35,54,63
4	038699	CAP CA 100V 100pF 5%	C33,40,50,52
1	039259	CAP CA 100V 220pF 5%	C46
3	038701	CAP CA 50V 470pF 5%	C7,15,25

# ULTIMATE CHORUS

## PRINTED CIRCUIT BOARD ASSEMBLY (CONT)

QTY	PART #	DESCRIPTION	REFERENCE DESIGNATION
1	038874	CAP CA 50V 560pF 5%	C19
2	039263	CAP CA 100V 1000pF 5%	C6,22
2	039264	CAP CA 100V 1500pF 5%	C44,81
5	039265	CAP CA 100V 2200pF 5%	C17,20,21,31,39
1	039266	CAP CA 100V 3300pF 5%	C18
1	039267	CAP CA 100V 3900pF 5%	C45
2	039268	CAP CA 50V 4700pF 5%	C1,2
1	038702	CAP CA 50V 6800pF 5%	C12
3	038703	CAP CA 50V .1uF 10%	C79,86,87
2	036234	CAP PF RDL 100V .015uF 10%	C23,24
2	033590	CAP PF RDL 100V .022uF 10%	C11,13
3	033591	CAP FP RDL 100V .033u 1%	C34,74,76
4	033592	CAP PF RDL 100V .047uF 10%	C43,47,75,77
1	033594	CAP PF RDL 100V .056uF 10%	C10
2	027281	CAP MPF 63V .22uF 10%	C9,27
3	027289	CAP MPF 63V .47uF 10%	C8,26,72
1	019994	CONTROL T-POT 100K PC MTG 20%	R75 (TRIMPOT CHORUS BIAS ADJ)
2	037937	CONTROL SNAPIN 2K 15A TAPER	R19,51 (MID)
4	027940	CONTROL SNAPIN 50K 15A TAPER	R17,18,49,50 (TREBLE, BASS)
4	027941	CONTROL SNAPIN 50K B TAPER	R11,43,60,63 (VOLUME, REVERB)
1	027942	CONTROL SNAPIN 50K 2B CTR DETN	R40 (PRESENCE)
2	027945	CONTROL SNAPIN 100K TAPER	R160,167 (RATE, DEPTH)
1	027947	CONTROL SNAPIN 100K 30C TAPER	R30 (GAIN)
47	006260	DIODE 1N4448 75 PRV	CR1-29,34,37,40,41,46,49,52-63
4	064089	DIODE 1N4003 200PRV 1AMP	CR38,39,50,51
8	028776	DIODE BIAS BYV26D LEAD FORMED	CR30-33,42-45
4	029045	DIODE 6A4 400V 6AMP LEAD FORMED	CR64-67
4	027329	DIODE ZENER 1N5228B 3.9V	CR35,36,47,48
2	028119	DIODE ZENER 1N5353B 16V 5 WATT	CR68,69
14	025802	FASTON TAB MALE .250X.032 PCB MT	CP1-14
2	025996	FUSE CLIP PCB .250 & 5mm FUSE	(@ XF1)
1	039982	FUSE QA 1-1/4"X1/4" 250V 4AMP	F1 (100/120V DOM)
1	020794	FUSE QA 20mmX5mm 250V 2 AMP	F1 (EXPORT 230V ONLY)
1	031725	HEATSINK PLATE (M-80)	(TRANSISTOR MOUNT)
8	016795	IC DUAL OP AMP TLO72C	U1-7,11
1	031611	IC DUAL OP AMP PC4560	U10
2	028047	IC OPAMP MC1436P1	U8,9
1	029671	IC MN3007 BUCKET BRIGADE	U13
1	029672	IC MN3101 CLOCK GEN/DRIVER	U12
4	036815	INSULATOR SILICONE TO-3P	(SIL PAD)
4	040903	INSULATOR MICA TO-218	(MICA PAD)
4	031570	JACK PHONE PCB STEREO PREMIUM	J1,2,5,6 (INPUTS STEREO SEND/RETURN)
3	037036	JACK PHONE PCB MONO CA PREMIUM	J3,4,7 (MONO SEND/RETURN)
18	020888	JUMPER WIRE 22GA .5X.175	W1-18
1	028039	LED 5X5mm RED SLB-55VR3	LD3 (DRIVE CHANNEL LED)
1	028098	LED 5X5mm GREEN SLV-55MG3	LD2 (NORMAL CHANNEL LED)
1	033177	LED 5X5mm BI-COLOR RED/GREEN	LD4 (CHORUS LED)
1	9902202281	LED RED LNG LEAD LUMEX CS02	LD1 (DISTORTION LED)
1	039245	PCB ULTIMATE CHORUS	(BLANK BOARD)
4	024947	RES CF 1/4W 470Ω 5%	R56,74,172,173
3	024952	RES CF 1/4W 100Ω 5%	R8,9,155
2	028015	RES CF 1/4W 130Ω 5%	R15,47
1	024961	RES CF 1/4W 470Ω 5%	R10
9	024965	RES CF 1/4W 1K 5%	R31,67,92,95,109,110,128,129,136
2	024969	RES CF 1/4W 1.5K 5%	R22,58
1	024972	RES CF 1/4W 2.7K 5%	R84
4	024973	RES CF 1/4W 3.3K 5%	R14,29,46,161
4	024975	RES CF 1/4W 3.9K 5%	R98,99,117,118
1	024977	RES CF 1/4W 4.7K 5%	R55
4	028034	RES CF 1/4W 5.1K 5%	R5,78,79,171
1	024979	RES CF 1/4W 6.8K 5%	R6
2	025942	RES CF 1/4W 7.5K 5%	R41,42
13	024981	RES CF 1/4W 10K 5%	R57,72,135,138,142,143,149,150,153,157-159,165

**ULTIMATE CHORUS  
PRINTED CIRCUIT BOARD ASSEMBLY (CONT)**

<b>QTY</b>	<b>PART #</b>	<b>DESCRIPTION</b>	<b>REFERENCE DESIGNATION</b>
1	029002	RES CF 1/4W 11K 5%	R26
2	024985	RES CF 1/4W 15K 5%	R7,25
5	024986	RES CF 1/4W 18K 5%	R81-83, 162,169
5	024987	RES CF 1/4W 22K 5%	R16,35,36,38,48
4	024988	RES CF 1/4W 27K 5%	R100,101,119,120
3	024989	RES CF 1/4W 33K 5%	R23,24,166
1	029004	RES CF 1/4W 36K 5%	R27
2	024991	RES CF 1/4W 39K 5%	R13,45
9	024993	RES CF 1/4W 47K 5%	R71,73,86,87,96,97,115,116,164,
1	024994	RES CF 1/4W 56K 5%	R12
3	024995	RES CF 1/4W 68K 5%	R1,2,37
1	028153	RES CF 1/4W 75K 5%	R44
1	024996	RES CF 1/4W 85K 5%	R54
13	024997	RES CF 1/4W 100K 5%	R65,66,69,70,76,77,90,91,96,94,137,470,168
2	024998	RES CF 1/4W 120K 5%	R20,61
1	024999	RES CF 1/4W 150K 5%	R21
2	025059	RES CF 1/4W 220K 5%	R59,85
2	025060	RES CF 1/4W 270K 5%	R52,62
2	025061	RES CF 1/4W 330K 5%	R80,170
3	025065	RES CF 1/4W 470K 5%	R53,68,163
3	028018	RES CF 1/4W 510K 5%	R3,4,32
1	025066	RES CF 1/4W 560K 5%	R64
2	025067	RES CF 1/4W 680K 5%	R102,121
1	025068	RES CF 1/4W 820K 5%	R39
10	025069	RES CF 1/4W 1M 5%	R33,34,88,139,141,144,147,148,151,152
2	025084	RES CF 1/4W 10M 5%	R28,89
1	027869	RES CF 1/2W 470Ω 5%	R154
2	028045	RES MF 1W 220Ω 5%	R107,126
4	028030	RES MF 1W 680Ω 5%	R103,105,122,124
1	029722	RES MF 1W 1K 5%	R156
5	028029	RES MF 1W 1.5K 5%	R104,106,123,125,134
2	028038	RES MF 1W 3.9K 5%	R145,146
4	037354	RES CF 1W 4.7K 5%	R108,111,127,130
6	028028	RES WW BT 5W .47Ω 10%	R112-114,131,133
1	028898	RES WW BT 5W 240Ω 5%	R174
1	036940	RES WW BT 5W 270Ω 10%	R175
4	027638	SCREW TF 4-40X3/8 HWH ZI	(TRANSISTOR MOUNTING)
6	032908	SCREW TF 6-32X3/8 PHP ZI	(HEATSINK TO PCB MOUNT)
1	029697	SHILED 6"X1.25"	
1	036178	SPACER LED .5X.1 BRN	(@ LD4)
2	9904701440	SPACER LED .7X.125 BLUE	(@ LD2,3)
4	025936	STANDOFF PCB PUSH ON NYL 3/8L	(PCB TO CHASSIS MOUNT)
3	028091	SWITCH PUSH SLFLK DPDT	S1,2,3 (WITHOUT BUTTON) (MID BOOST, DDRIVE SELECT, CHORUS SELECT)
1	026411	THERMISTOR 2.2Ω 8AMP	TH1
4	028169	WASHER SHLDR NYL 5/32X1/4	(TRANSISTOR MOUNTING)
7	014689	XISTOR N-CH JFET J111 TO-92	Q12,14
2	016739	XISTOR NPN 2N4401 TO-92	Q12,14
1	016742	XISTOR PNP 2N4403 TO-92	Q13
2	028114	XISTOR NPN TIP142 TO-218AC	Q8,10
2	028115	XISTOR PNP TIP147 TO-218AC	Q9,11

**CHASSIS ASSEMBLY**

<b>QTY</b>	<b>PART #</b>	<b>DESCRIPTION</b>	<b>REFERENCE DESIGNATION</b>
1	039248	CHASSIS ASSY ULTRA CHORUS 120V	(COMPLETE CHASSIS)
2	021709	BUSHING SR .437X.062X13/32 BLK	(@ SPEAKER CABLE)
1	026116	BUSHING SR .500X.063X7/16 BLK	(@ REVERB CABLE)
1	026038	BUSHING SR .625X.062X37/64 BLK 100/120V	(@ POWER CABLE)
1	010401	BUSHING SR .625X.125X37/64 WHT 230V	(@ POWER CABLE)
1	026541	CABLE ASSY PWR W/.250 TAB 120V	(POWER CABLE 100/120V)
1	033331	CABLE ASSY PWR W/.250 TAB 230V	(PWR CABLE 230V EXPORT)

## ULTIMATE CHORUS CHASSIS ASSEMBLY (CONT)

QTY	PART #	DESCRIPTION	REFERENCE DESIGNATION
1	038602	CABLE ASSY PWR AUST W/.250 TAB	(240V AUSTRALIA ONLY)
1	033045	END BELL XFMR (PWR CHOR)	(TRANSFORMER MOUNT)
1	031726	HEATSINK BAR (M-80)	(COUPLER TO CHASSIS)
14	026402	KNOB POINTER BLAKC	
4	028591	NUT ACORN 8-32	(TRANSFORMER MOUNT)
1	049104	PANEL FRONT LEXAN ULTIMATE CHROUS	
1	049105	PANEL REAR VINYL ULTIMATE CHORUS	
5	028500	SCREW TF 8-32X3/4 SLTD HWH ZI	(HEATSINK TO CHASSIS)
4	028937	SCREW TF 6-32X5/8 ROLOK PHP ZI	(PCB TO CHASSIS MOUNT)
1	038900	SCREW TF 6-32X1/4 [J] ZO	(@ GROUND LUG)
1	039236	SWITCH PWR ROCKER DPST PSEUDO-IEC .870"X1.181" HOLE	(100/120V)
1	040582	SWITCH PWR ROCKER DPST IEC .870"X1.181" HOLE	230V EXPORT
4	030007	WASHER LOCK INTL 8X.330X.02 ZI	(TRANSFORMER MOUNT)
1	031668	XFORMER PWR 120V 125 WATT	(120V DOMESTIC)
1	039253	XFORMER PWR 100/230V 125 WATT	(100V/115V/230V EXPORT)

## CABINET ASSEMBLY

QTY	PART #	DESCRIPTION	REFERENCE DESIGNATION
1	040071	CABINET ASSY ULTRA CHORUS/PRO 185	(COMPLETE CABINET)
4	023505	CASTER MOUNTING PLATE	
4	023513	CASTER SWIVEL STEEL	
4	026566	CORNER 2 HOLE W/ TAB NI	(BOTTOM FRONT, TOP REAR)
2	026568	CORNER 3 HOLE NI	(BOTTOM REAR)
4	029821	EYELET RFLNGD .215 OD X.315 L	BRASS (REVERB PAN MOUNT)
4	019275	GLIDE CUSHION INSERT	(RUBBER ONLY)
4	019276	GLIDE CABINET 1.24X.335 NI	(STEEL ONLY)
1	040072	GRILLE ASSY "ULTRA CHORUS"	(COMPLETE GRILLE)
1	011298	NAMEPLATE FENDER SMALL	(LOGO)
12	021972	NUT T 10-32X3/4 STR 3 PRNG BLX	(SPEAKER, HANDLE MOUNT)
1	028055	REVERB UNIT 800 OHM 8EB2C1B DN	(PAN)
4	022244	SCREW M 10-32X1-1/8 OHP NI	(HANDLE MOUNTING)
10	026571	SCREW CORNER MOUNTING	
4	026625	SCREW WOOD 8X1" FH	(GLIDE MOUNTING)
16	027199	SCREW SMAB 10X3/4 PHP NI	(CASTER PLATE MOUNT)
2	018113	SCREW SMA #4X1/2" OHP BLX	(NAMEPLATE MOUNTING)
8	026577	SCREW M 10-32X1" PHP BLX	(SPEAKER MOUNTING)
5	029828	SCREW PB 8X3/4 PHP ZI	(REVERB PAN/CBL CLMP MT)
6	036199	SCREW M 8-32X1-3/16 OHP BLX WX	(CHASSIS MOUNT)
2	025923	SPEAKER 12" 8 OHM 75 WATT	
6	029527	WASHER FNSH 8-5/8 FLNDG BLX WX	(CHASSIS MOUNT)

## FOOTSWITCH ASSEMBLY

QTY	PART #	DESCRIPTION	REFERENCE DESIGNATION
1	029972	FOOTSWITCH 2 BTTN CHAN/CHORUS	(COMPLETE FOOTSWITCH)
1	028895	CABLE ASSY FOOTSWITCH RT ANGLE 12"	(FOOTSWITCH CABLE)
2	006260	DIODE 1N4448 SIGNAL BENT 75PRV	CR1,2
1	037036	JACK PHONE PCB MONO CA PREMIUM	J1
2	028039	LED 5x5mm RED SLB-55VR3	LD1,2
1	028448	PCB ASSY FTSW 2 BUTTON	(STUFFED)
2	034921	SPACER .147X.250X.780 RND NYLON	(LED SPACERS)
8	028889	SCREW SMB #6X1/4" PHP	(END PANEL MOUNT)
2	028714	SWITCH PUSH SPDT	S1,2
2	031899	WASHER NYL .485X.775X.150 TK	(SWITCH SPACER)

## MISCELLANEOUS

QTY	PART #	DESCRIPTION	REFERENCE DESIGNATION
1	049106	MANUAL OWNERS ULTIMATE CHORUS	
1	039243	SCHEM W/SERVICE DA. "ULTRA CHORUS"	(USE FOR "ULTRA CHORUS" AND "ULTIMATE CHORUS")



ZONE	REV. DESCRIPTION	DATE	APPROVED
A	RELEASED PR#204	8-7-92	[Signature]
B	EC#887	10-12-92	[Signature]
C	EC#932	1-29-93	[Signature]
D	ECO#L02791	1-4-94	[Signature]
E	EC#1292	10-17-94	[Signature]

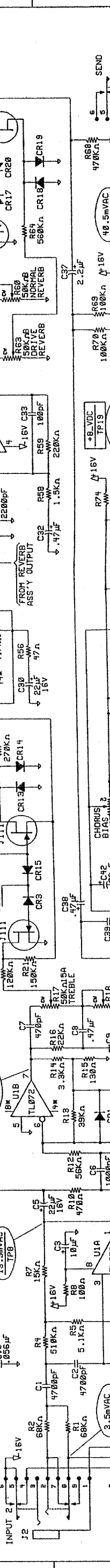
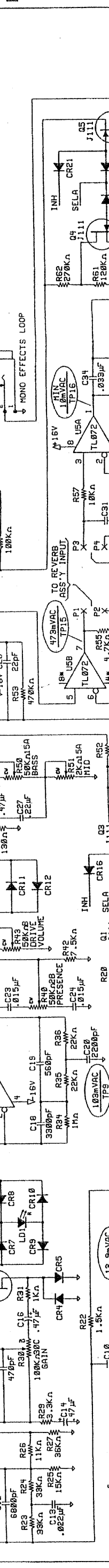
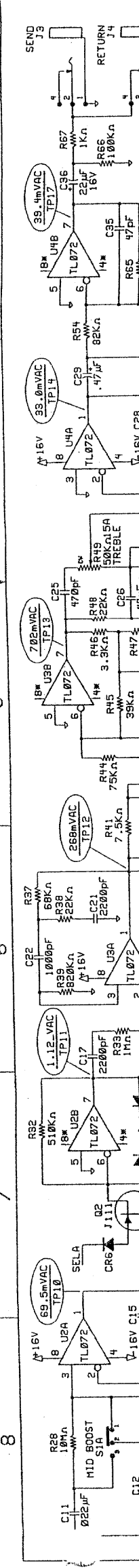

1 2 3 4 5 6 7 8

REVISIONS		
ZONE	REV. DESCRIPTION	DATE APPROVED
A	RELEASED PR #204	8-7-92
B	EC#1292	10-17-94

FILM/DWG: SERVICE DIAGRAM  
 DATABASE: ULTRASER DATE: 17-OCT-94  
 LAYERS PLOTTED: 1 2 3 4 10  
 15 19

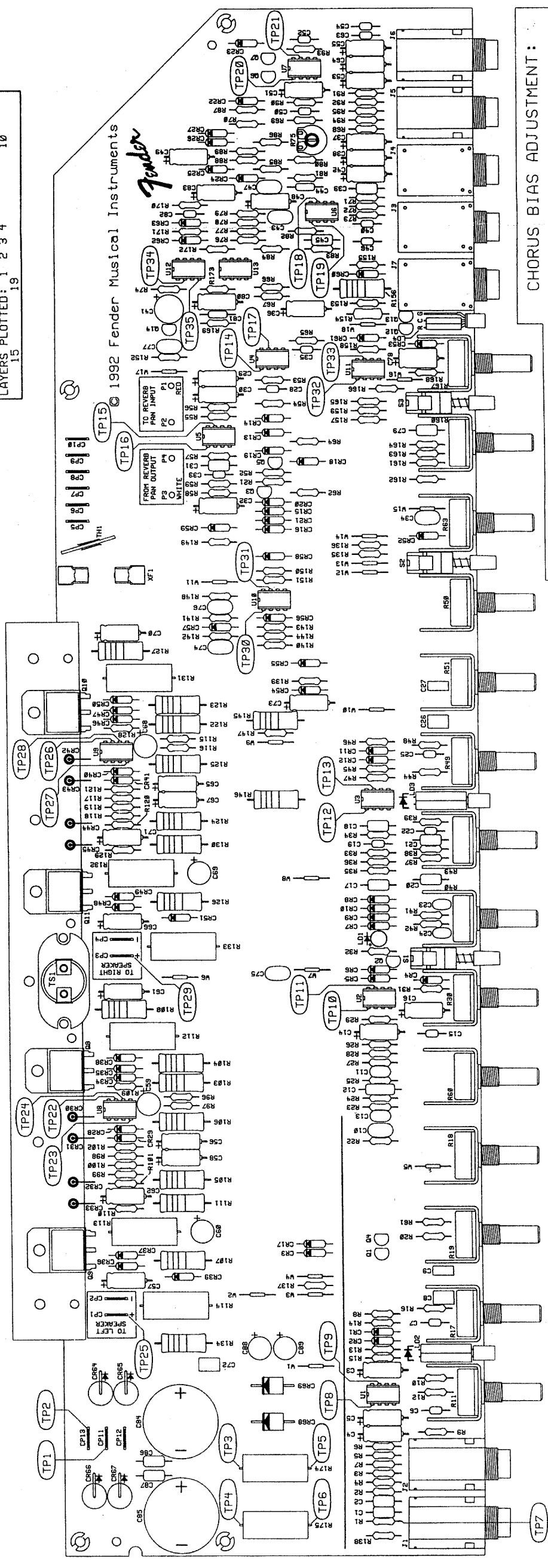
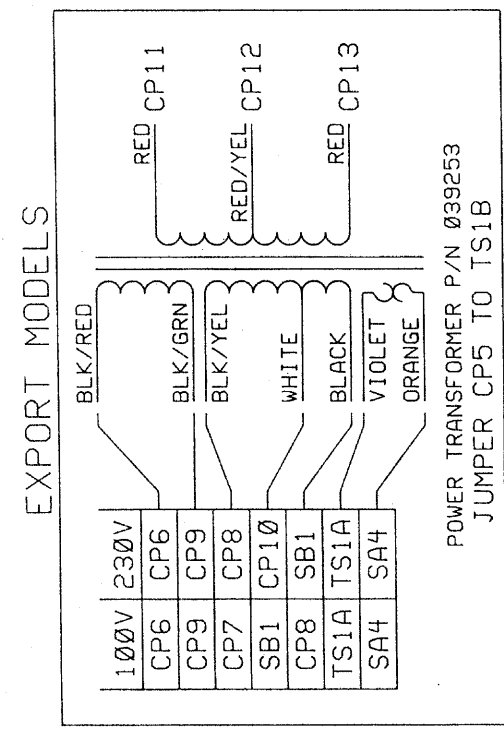
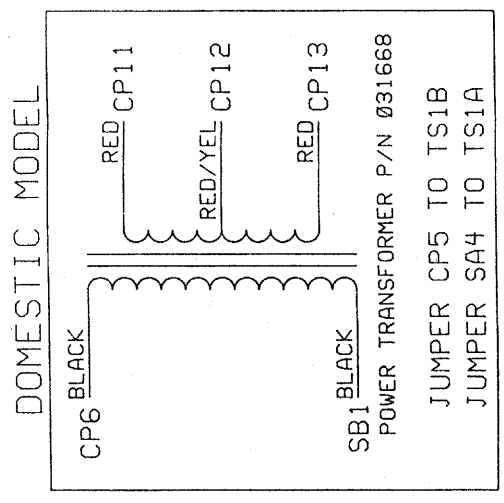

**CHORUS BIAS ADJUSTMENT:**

WITH CHORUS SELECT ON, SET CHORUS RATE AND DEPTH CONTROLS FULLY CLOCKWISE. CONNECT A 1KHZ SINEWAVE AT ABOUT 1.5 VOLTS RMS TO THE MONO EFFECTS LOOP RETURN JACK (J4). ADJUST TRIMPOT R75 FOR SYMMETRICAL CLIPPING AT U6 PIN 1 (TP19).

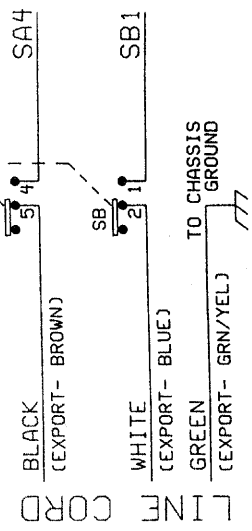
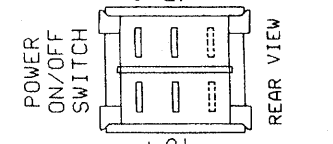

<b>PROPRIETARY</b>	<b>MUSICAL INSTRUMENTS</b>
THIS DRAWING CONTAINS INFORMATION WHICH IS PROPRIETARY TO FENDER MUSICAL INSTRUMENTS CO. AND MAY NOT BE USED, REPRODUCED OR DISCLOSED IN ANY MANNER WITHOUT THE EXPRESS WRITTEN CONSENT OF FENDER MUSICAL INSTRUMENTS CO.	
DATE: 11-2-94	DATE: 17-14
APPROVED: [Signature]	CHECKED BY: [Signature]
TOLERANCES: UNLESS OTHERWISE SPECIFIED	REGIONS: REGIONAL HEADQUARTERS
X.X ±0.050"	2821 RESEARCH DRIVE
X.XX ±0.010"	CORONA, CA 91728 USA
X.XXX ±0.005"	
ANGLES	
NEXT HIGHER ASSEMBLY:	ULTIMATE CHORUS
SIZE: B	DRAWING NUMBER: 039244
REV. B	REV. B
ENGR: B. DESI	DRAWING NUMBER: 039244
SCALE: 1 OF 1	CREATED: 28-JUL-92
	PLOTTED: 17-OCT-94

1 2 3 4 5 6 7 8