

# P1500 / P3000

## Installation & Operation



# Hafler<sup>®</sup>

# trans•nova

**MADE  
IN THE  
USA**

**PROFESSIONAL POWER AMPLIFIER**

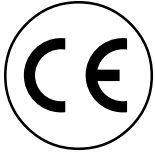

# Declaration of Conformity

Application of Council Directive: 73 / 23 / EEC (Low Voltage Directive)  
89 / 336 / EEC (EMC Directive)

Standard(s) to which Conformity is Declared: EN55103-1  
EN55103-2  
EN60065

Manufacturer's Name: Hafler

Manufacturer's Address: 546 South Rockford Drive, Tempe, Arizona 85281

Importer's Name: \_\_\_\_\_

Importer's Address: \_\_\_\_\_

Type of Equipment: 2-channel Audio Power Amplifier/Speaker

Model No.: **P1000CE**  **P1500CE**  **P3000CE**  **P4000CE**  **9505CE**   
**TRM6CE**  **TRM8CE**  **TRM10sCE**  **TRM12sCE**

Year of Manufacturing: **1999**  **2000**  **2001**  **2002**  **2003**

Serial Number: \_\_\_\_\_

*I, the undersigned, hereby declare that the equipment specified above conforms to the above Directive(s) and Standard(s)*

Place: **Hafler**

Date: **09/01/1999**

**James C. Strickland, VP Engineering**

# PERFORMANCE SPECIFICATIONS

## P1500/P3000

Frequency Response: 20Hz to 20kHz,  $\pm 0.1$ dB  
 0.15Hz to 300kHz,  $+0/-3$ dB

Signal-to-Noise:  $>100$ dB "A" Weighted

Distortion:  $<0.2\%$  20-20kHz, typically .01% at 1kHz @ rated power into  $8\Omega$

Slew Rate: 100 V/ $\mu$ s

CMRR: 75dB at 1kHz

Input Impedance: 47k ohms per phase

Gain: +14dB min.  
 +29dB max.

## P1500

Power Rating: 75 wpc @  $8\Omega$ , 85 wpc @  $4\Omega$ , 170 Watts mono @  $8\Omega$

Damping Factor: 350 (to 1kHz); 150 (to 10kHz); 18 (to 100kHz)

Input Sensitivity Range: 870mV - 4.8V (for 75 W @  $8\Omega$ )  
 650mV - 3.7V (for 85 W @  $4\Omega$ )

Power Consumption: 60W / 500mA @ 120 VAC (Idle Power)  
 230W / 1.9A @ 120 VAC (1/8 Power -  $8\Omega$ )  
 325W / 2.70A @ 120 VAC (Max. Power -  $8\Omega$ )

Dimensions: 19"W x 8-1/2"D x 3-1/2"H (2-rack spaces)  
 (48.26cm x 21.59cm x 8.89cm)

Net Weight: 22 lbs. (9.98kg)

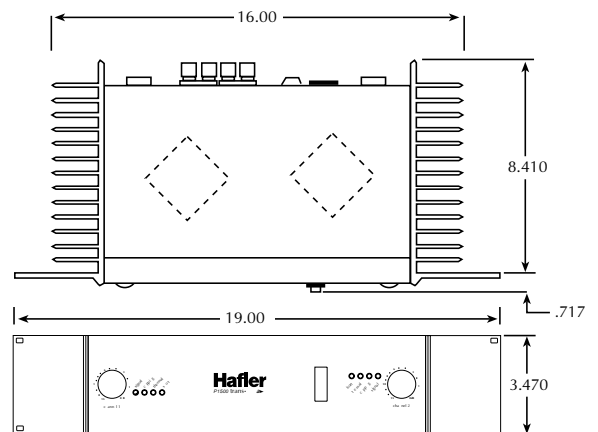

**P1500**

## P3000

Power Rating: 150 wpc @  $8\Omega$ , 200 wpc @  $4\Omega$ , 400 Watts mono @  $8\Omega$

Damping Factor: 400 (to 1kHz); 200 (to 10kHz); 18 (to 100kHz)

Input Sensitivity Range: 1.2V - 6.9V (for 150 W @  $8\Omega$ )  
 1.0V - 5.6V (for 200 W @  $4\Omega$ )

Power Consumption: 120W / 1.00A @ 120 VAC (Idle Power)  
 350W / 2.9A @ 120 VAC (1/8 Power -  $8\Omega$ )  
 600W / 5.00A @ 120 VAC (Max. Power -  $8\Omega$ )

Dimensions: 19"W x 9-7/8"D x 3-1/2"H (2-rack spaces)  
 (48.26cm x 25.08cm x 8.89cm)

Net Weight: 23 lbs. (10.43kg)

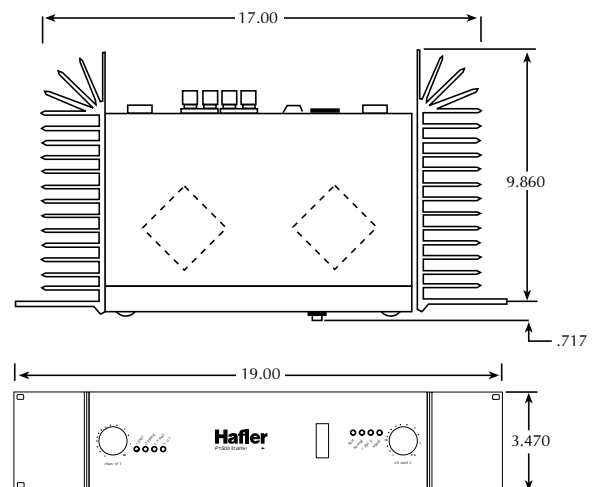

**P3000**

# NOTICE - IMPORTANT SAFETY INFORMATION

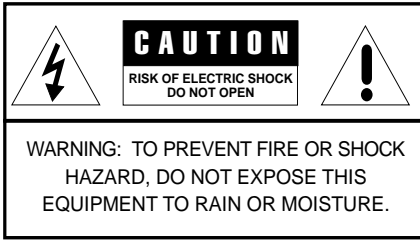

The lightning flash with arrowhead symbol within an equilateral triangle is intended to alert the user to the presence of uninsulated "dangerous voltage" within the product's enclosure, that may be of sufficient magnitude to constitute a risk of electric shock to persons.

The exclamation point within an equilateral triangle is intended to alert the user of the presence of important operating and maintenance (servicing) instructions in the literature accompanying the appliance.

## 1. READ INSTRUCTIONS

All the safety and operating instructions of your Hafler equipment should be read before power is applied to the equipment.

## 2. RETAIN OWNER'S MANUAL

These safety and operating instructions should be retained for future reference.

## 3. HEED WARNINGS

All warnings on the equipment and in the operating instructions are important and should be followed.

## 4. FOLLOW INSTRUCTIONS

All operating and use instructions are important and should be followed.

## 5. HEAT

The equipment should be kept away from areas of high temperature, i.e., heater vents, radiators, stoves/ovens, fireplaces, etc.

## 6. VENTILATION

The equipment should be used in an area suitable for proper ventilation. Care should be taken not to impede airflow in and around the cabinet. Do not mount on a carpeted shelf or in a sealed enclosure. Allow for proper clearance above the equipment.

## 7. WATER AND MOISTURE

The equipment should not be used in or around water, such as a bathtub, sink, or swimming area. Also, the equipment should not be used in areas prone to flooding, such as a basement.

## 8. POWER SOURCES

The equipment should be connected only to a power source of the same voltage and frequency as that listed on the rear panel above the power cord entry point.

## 9. POWER CORD PROTECTION

Power cords should be arranged so they do not interfere with the movement of objects in the room: people, fan blades, utility carts, etc. Also, care should be taken that the cord is not pinched or cut, and placed so it is not in danger of being pinched or cut, as in under a rug, around a tight corner, etc.

## 10. POWER CORD GROUNDING

The power supply cord is of a three wire grounded type, designed to reduce the risk of electric shock sustained from a live cabinet. It is assumed to be of suitable length for most uses of the equipment. The use of extension cords and power strips is discouraged unless they are of suitable rating to deliver the required total current for safe operation of all connected equipment. Furthermore, extension cords or power strips must provide

the same three wire grounded connection. It is important that the blades of the equipment's plug be able to fully insert into the mating receptacle. **Never remove the round grounding pin on the plug in an attempt to mate to a two wire ungrounded receptacle:** use a grounding adaptor with the grounding tab or wire suitably connected to earth ground.

## 11. NON-USE PERIODS

During periods of extended non-use, the power cord should be unplugged from the power source.

## 12. CLEANING

The equipment should be cleaned only as detailed in the operating instructions.

## 13. OBJECT AND LIQUID ENTRY

Care should be taken so that objects and/or liquids, such as cleaning fluids or beverages, are not spilled into the enclosure of the equipment.

## 14. DAMAGE REQUIRING SERVICE

Hafler equipment should be serviced by qualified service personnel when:

- A. The power supply cord or plug has been damaged, or
- B. Objects have fallen, or liquid has been spilled into the equipment, or
- C. The equipment has been exposed to rain, or
- D. The equipment does not appear to operate normally or exhibits a marked change in performance, or
- E. The equipment has been dropped, or the enclosure has been damaged.

## 15. SERVICING

The user should not attempt to service the equipment beyond that which is described in the operating instructions. All other service should be referred to qualified service personnel.

## 16. CARTS AND STANDS

The equipment should be used with carts or stands only of sufficient strength and stability for the use intended.

An equipment and cart combination should be moved with care. Quick stops and starts, excessive force, and uneven surfaces may cause the equipment and cart combination to topple.

## ADVERTENCIA – INFORMACION DE SEGURIDAD IMPORTANTE



El símbolo de flecha relámpago dentro de un triángulo equilátero, es para alertar al usuario de la presencia de “voltajes peligrosos” no aislados en el interior del aparato, los cuales pueden ser de suficiente magnitud para constituir un riesgo de choque eléctrico a las personas.

El símbolo de exclamación dentro de un triángulo equilátero, es para alertar al usuario de la presencia de instrucciones importantes de operación y mantenimiento (servicio) en la documentación que acompaña al equipo.

### 1. LEA LAS INSTRUCCIONES

Todas las instrucciones de seguridad y operación de su equipo Hafler, deben ser leídas antes de que el equipo sea conectado eléctricamente.

### 2. CONSERVE EL MANUAL DEL PROPIETARIO

Estas instrucciones de seguridad y operación, deben ser conservadas para futuras referencias.

### 3. CUADROS DE ADVERTENCIAS

Todas las advertencias en el equipo y en las instrucciones de operación, son importantes y deben ser seguidas.

### 4. SIGA LAS INSTRUCCIONES

Todas las instrucciones de uso y operación son importantes y deben ser seguidas.

### 5. CALOR

El equipo debe ser mantenido lejos de áreas de alta temperatura, como por ejemplo: ventilaciones de calentadores, radiadores, estufas/hornos, hogueras, etc.

### 6. VENTILACION

El equip debe ser usado en áreas con ventilación adecuada. Deben er tomadas las precauciones necesarias para no impedir el flujo de aire dentro y alrededor del aparato.

### 7. AGUA Y HUMEDAD

El equipo no debe ser usado en el agua ó alrededor de ésta, tales como en una bañera, tanque o áreas de nado. También, el equipo no debe ser usado en áreas propensas a inundaciones, tales como en un sótano.

### 8. FUENTES DE PODER

El equipo debe ser conectado a una fuente de poder del mismo voltaje y frecuencia que el indicado en el panel trasero sobre el punto de entrada del cable de corriente.

### 9. PROTECCION DEL CABLE DE CORRIENTE

Los cables de corriente deben ser dispuestos de forma tal que no interfieran con el movimiento de objetos en la sala: personas, aspas de ventilación, carretillas, etc. También, es necesario tener cuidado de que el cable no esté punzado o cortado, y debe estar ubicado de forma tal que esto no ocurra, como podría suceder debajo de una alfombra o al pasar el cable por una esquina aguda, etc.

### 10. ATERRAMIENTO DEL CABLE DE CORRIENTE

El cable de corriente es del tipo aterrado de tres hilos, diseñado para reducir el riesgo de una descarga eléctrica procedent de un chasis energizado. Se asume que su longitud es suficiente para la mayoría de usos del equipo. El uso de extensiones y multienchufes no es recomendado, a menos que tengan el amperaje adecuado para

poder suministrar la corrioente requerida pra la operación segura de todo el equipo conectado. Aun más, las extensiones deben proveer de la misma conección aterrada de tres hiles. Es importante que el enchufe se pueda introducir completamente en el receptáculo. Nunca remeva el pin de aterramiento en un intento por conectar el cable en un receptáculo de dos hilos no aterrado: use un adaptador de aterramiento que esté adecuadamente conectado a un punto de tierra.

### 11. PERIODOS SIN USO

Durante períodos prolongados sin uso del equipo, el cable de corriente debe ser desconectado de la fuente de electrixidad.

### 12. LIMPIEZA

El equip debe ser limpiado solo en la forma que se detalla en las instrucciones de operación.

### 13. INTRODUCCIÓN DE OBJETOS Y LIQUIDO

Deben ser tomadas precauciones con el fin de que objetos y/ó líquidos, tales como fluidos de limpieza y gaseosas, no sean derramados dentro del chasis del aparato.

### 14. DAÑOS QUE REQUIEREN DE SERVICIO

Los equipos Hafler deben ser llevados a servicio por personal calificado cuando:

- A. El cable de corriente ó el enchufe haya sido dañado, ó
- B. Objetos ó líquido hayan sido introducidos ó derramado en el equipo, ó
- C. El equipo haya sido expuesto a lluvia, ó
- D. El equipo aparenta no operar normalmente ó exhibe un marcado cambio en su desempeño, ó
- E. El equipo se ha caído, o el chasis ha sido golpeado.

### 15. SERVICIO

El usuario no deberá intentar darle servicio al equipo más allá de lo que está descrito en el instructivo de operación. Todo lo demás, deberá ser referido a servicio por personal calificado.

### 16. CARRETIILLAS Y SOPORTES

El equipo podrá ser usado con carretillas y soportes que tengan la fortaleza y estabilidad suficiente para el uso previsto.

La combinación equipo/carretilla deberá ser movida con cuidado. Rápidas paradas y arranques, excesiva fuerza y superficies imparejas, pueden causar el volcamiento del conjunto de carretilla/equipo.

# ATTENTION: INFORMATIONS IMPORTANTES DE SÉCURITÉ



La lumière clignotante du symbole de la flèche à l'intérieur d'un triangle équilatéral, à pour objet d'alerter l'utilisateur de la présence "d'un voltage dangereux" non-isolé à l'intérieur du produit, qui pourrait être de magnitude suffisante au risque d'électrocution.

Le point d'exclamation, à l'intérieur d'un triangle équilatéral, à pour objet de prévenir l'utilisateur de l'importance des instructions de fonctionnement et de maintenance, jointes à l'appareil.

## 1. LIRE LES INSTRUCTIONS

Le mode d'emploi et les mesures de sécurité de votre équipement Hafler devraient être consultés avant sa mise en marche.

## 2. CONSERVER LE GUIDE DE L'UTILISATEUR

Le mode d'emploi et les mesures de sécurité devraient être conservés pour des références futures.

## 3. CONSIDÉRATIONS DE MISE EN GARDE

Le mode d'emploi et les mises en garde concernant cet équipement sont de grande importance et devraient être suivis.

## 4. SUIVRE LE MODE D'EMPLOI

Le mode d'emploi et les conseils d'utilisation sont importants et devraient être suivis.

## 5. CHALEUR

Le matériel devrait être préservé loin de toute source de chaleur: radiateurs, cuisinière/fours, cheminées,...etc.

## 6. VENTILATION

Le matériel devrait être utilisé dans un endroit à bonne ventilation. Il reste nécessaire de respecter la circulation de flux d'air à l'intérieur et autour du meuble.

## 7. EAU ET HUMIDITÉ

Le matériel ne devrait pas être utilisé près d'une source d'eau, telle qu'une baignoire, un évier, ou une aire de baignade. De plus, le matériel ne devrait pas être utilisé dans des lieux sujets aux inondations, tels que les sous-sols.

## 8. SOURCES D'ÉNERGIE

Le matériel devrait seulement être relié à une source d'énergie de même voltage et fréquence que celle indiquée sur le tableau arrière, au dessus de la fiche d'entrée de la prise de courant.

## 9. PROTECTION DE LA PRISE DE COURANT

La prise de courant devrait être arrangée de façon à ne pas interférer avec le déplacement d'objets (chariots, pales de ventilateurs...etc.) ou de personnes à l'intérieur de la pièce. D'autre part, il faudrait faire très attention à ce que la prise ne soit pas percée ou coupée, ou disposée de façon à risquer de l'être, comme sous un tapis, autour d'un angle pointu...etc.

## 10. PRISE DE COURANT À TROIS FICHES

La prise de courant est composée de trois fiches, désignées à réduire le risque de décharge électrique de l'appareil.

Elle devrait être de longueur suffisante pour la plupart des utilisations de ce matériel. L'utilisation de rallonge et d'adaptateur est déconseillée à moins d'être en mesure de fournir la charge électrique requise à un fonctionnement sans risque, de tout matériel relié.

## 11. PÉRIODES DE NON-UTILISATION

Durant les périodes de non-utilisation, la prise de courant ne devrait pas être branchée à une source d'énergie.

## 12. NETTOYAGE

Le matériel devrait être nettoyé en respectant les instructions indiquées.

## 13. PENÉTRATION DES LIQUIDES

Une attention particulière est exigée quant à la dispersion de liquides tels que les produits de nettoyage et boissons, de façon à éviter toute pénétration dans l'enceinte du matériel.

## 14. DÉGÂT NÉCESSITANT UNE RÉVISION

Le matériel Hafler devrait être révisé par des personnes qualifiées de service après-vente, lorsque:

- A. Les fiches ou la prise de courant ont été endommagés, ou:
- B. Des objets sont tombés sur le matériel, ou des liquides s'y sont dispersés, ou:
- C. Le matériel a été exposé à la pluie, ou:
- D. Le matériel ne semble pas fonctionner correctement, ou affiche un changement de performance, ou:
- E. Le matériel a été renversé à terre, ou l'enceinte a été endommagée.

## 15. RÉVISION

L'utilisateur ne devrait pas essayer de réviser le matériel en allant plus loin que ce qui a été décrit dans le mode d'emploi. Toute autre révision devrait être confiée à un personnel qualifié.

## 16. CHARRIOTS ET MEUBLES

Le matériel devrait être utilisé avec des chariots et meubles de qualité et stabilité suffisante à son utilisation préconçue.

L'ensemble du matériel et du charriot devrait être déplacé avec précaution. Des mises en marche et arrêts brusques, des collisions excessives ainsi que des surfaces inégales peuvent renverser l'ensemble du matériel et du charriot.

# ACHTUNG – WICHTIGE SICHERHEITS – INFORMATIONEN



Der Blitz mit dem Pfeil, in einem gleichschenkligen Dreieck, soll den Benutzer vor unisolierter "gefährlicher Spannung" innerhalb des Gerätes warnen.

Das Ausrufezeichen, in einem gleichschenkligen Dreieck, soll den Benutzer darauf aufmerksam machen, daß dem Gerät wichtige Operations- und Service-Informationen beigelegt sind.

## 1. INSTRUKTIONEN LESEN

Alle Sicherheits- und Operationshinweise Ihres Hafler Equipments sollten vor der Inbetriebnahme gelesen werden.

## 2. BETRIEBSANLEITUNG AUFBEWAHREN

Bewahren Sie die Bedienungsanleitung sorgfältig auf, damit Sie in dieser auch in Zukunft nachschlagen können.

## 3. WARNUNGEN BEACHTEN

Alle Warnungen des Gerätes und der Bedienungsanleitung sind extrem wichtig und müssen befolgt werden.

## 4. INSTRUKTIONEN BEACHTEN

Alle Operations- und Gebrauchshinweise sind extrem wichtig und müssen beachtet werden.

## 5. HITZE

Das Equipment sollte fern von Hitze ausstrahlenden Geräten aufgestellt werden, wie z.B. Heizungen, Öfen etc.

## 6. VENTILATION

Das Equipment sollte so aufgestellt werden, daß eine ausreichende Ventilation gewährt wird.

## 7. WASSER UND FEUCHTIGKEIT

Das Equipment sollte nicht im oder in der Nähe von Wasser benutzt werden, wie z.B. in Schwimmbädern, Saunen etc. Es sollte ebenfalls nicht in Überschwemmungsgefährdeten Gebieten aufgestellt werden, wie z.B. Kellerräumen.

## 8. STROMANSCHLUß

Das Equipment darf nur an eine Stromversorgung angeschlossen werden, die die gleichen Parameter aufweist, welche auf der Rückseite, über dem Anschlußterminal des Gerätes, aufgelistet sind.

## 9. SCHUTZ DER ZULEITUNG

Die Zuleitungen sollten so verlegt werden, daß diese nicht in den Bewegungsbereich anderer Möbelstücke oder Personen hereinragen. Achten Sie darauf, das das Kabel nicht gequetscht oder durchschnitten wird, wie z.B. unter Schränken oder an scharfen Kanten etc.

## 10. MASSEANSCHLUß

Das dreidrädrige Anschlußkabel ist mit einem Erdungsleiter ausgestattet, welcher die Risiken eines Elektroschocks verringert. Das Kabel hat eine Länge, welche für die meisten Anwendungen völlig ausreicht. Wenn Sie Verlängerungskabel benutzen, achten Sie darauf, das dies die erforderlichen Ströme übertragen können. Benutzen Sie immer dreidrädrige Verlängerungskable.

## 11. ZEITRÄUME IN DENEN DAS GERÄT NICHT GENUTZT WIRD

Wird das Gerät über einen längeren Zeitraum nicht genutzt (z.B. Urlaub), ziehen Sie bitte den Netzstecker aus der Steckdose.

## 12. REINIGEN

Reinigen Sie das Gerät nur, wie in der Bedienungsanleitung detailliert beschrieben.

## 13. EINDRINGEN VON FREMDKÖRPERN

Achten Sie darauf, daß weder Fremdkörper, noch Flüssigkeiten in das Gerät eindringen.

## 14. ERFORDERLICHER REPARATURSERVICE

Hafler Equipment sollte nur von qualifizierten Service-Technikern instand gesetzt werden, wenn:

A. Das Stromversorgungskabel beschädigt wurde

B. Eine Flüssigkeit in das Gerät eingedrungen ist

C. Das Gerät Regen ausgesetzt wurde

D. Das Gerät nicht mehr ordnungsgemäß funktioniert, ggf. nicht mehr die volle Leistung abgibt

E. Das Gerät runtergefallen ist oder das Gehäuse beschädigt wurde

## 15. SERVICE

Der Benutzer sollte nur den Service ausführen, der in der Bedienungsanleitung für den Benutzer freigegeben wird. Den weiterführenden Service sollte nur von qualifizierten Technikern durchgeführt werden.

## 16. AUFSTELLUNG

Das Equipment sollte so aufgestellt werden, daß der gewählte Untergrund die erforderliche Stabilität aufweist, so daß eine gefahrlose Benutzung gewährleistet wird.

Das Equipment und der Untergrund sollte mit äußerster Vorsicht bewegt werden. Bei schnellen Bewegungen oder starkem Abbremsen, kann es zum Umkippen des Equipments kommen.

## NOTARE – IMPORTANTI INFORMAZIONI SULLA SICUREZZA



Il simbolo del fulmine in un triangolo equilatero vuole avvertire della presenza di tensioni elevate non isolate e di valore sufficiente per costituire rischio di shock elettrico alle persone.

Il punto esclamativo contenuto in un triangolo equilatero vuole avvertire l'utente della presenza di parti di servizio e di manutenzione che sono dettagliate nel manuale di istruzioni.

### 1. LEGGETE LE ISTRUZIONI

Tutte le istruzioni riguardanti la sicurezza ed il funzionamento devono essere lette prima di applicare tensione all'apparato.

### 2. CONSERVATE IL MANUALE

Queste istruzioni riguardanti la sicurezza ed il funzionamento devono essere conservate come riferimento futuro.

### 3. AVVERTENZE

Tutte le avvertenze poste sull'apparato e sul libretto di istruzioni sono importanti e devono essere seguite.

### 4. SEGUIRE LE ISTRUZIONI

Tutte le istruzioni operative e di funzionamento devono essere seguite.

### 5. TEMPERATURA

L'apparato deve essere mantenuto lontano da tutte le zone ad alta temperatura, termosifoni, termoconvettori, stufe e forni, caminetti ed altro.

### 6. VENTILAZIONE

L'apparato deve essere posizionato in aree convenienti per una corretta ventilazione. Prestare attenzione che sia consentita circolazione d'aria attorno e dentro il cabinet.

### 7. ACQUA E POLVERE

L'apparato deve essere posizionato lontano da zone contenenti acqua, come vasche a bagno, acquari e piscine. Inoltre non deve essere impiegato in aree soggette ad allagamento, come le cantine.

### 8. REQUISITI DI ALIMENTAZIONE

L'apparato deve essere connesso solo ad un'alimentazione della stessa tensione e frequenza di quanto scritto sulla parte posteriore del telaio.

### 9. PROTEZIONE DEL CAVO DI ALIMENTAZIONE

Il cavo di alimentazione deve essere posizionato in modo di non interferire con il movimento di oggetti nella stanza: persone, ventilatori, carrelli, ecc...prestate attenzione anche che il cavo non sia tagliato o spellato e che non possa tagliarsi e spellarsi.

### 10. MESSA A TERRA

Il cavo di alimentazione è del tipo a tre fili con terra ed è progettato per ridurre il rischio di shock elettrici. Si presume che sia della lunghezza sufficiente per la maggior parte degli impieghi. L'impiego di prolunghe e adattatori è sconsigliato se questi non garantiscono la potenza sufficiente per il corretto funzionamento degli apparati connessi. È altresì importante che vengano sempre impiegate prolunghe con la configurazione a tre fili con terra.

### 11. PERIODI DI NON UTILIZZO

Durante lunghi periodi di non utilizzo, staccare il cavo di alimentazione.

### 12. PULIZIA

L'apparato deve essere pulito solo come indicato dalle istruzioni.

### 13. INGRESSO DI OGGETTI E LIQUIDI

Si deve prestar attenzione che oggetti e liquidi, come fluidi detergenti e bibite, non vengano versati all'interno dell'apparato.

### 14. RIPARAZIONI

Gli apparati Hafler devono essere riparati da personale qualificato quando:

A. Il cavo di alimentazione o la spina sono danneggiati

B. Oggetti sono caduti all'interno del telaio o quando del liquido è entrato

C. Quando l'apparato è stato esposto a pioggia

D. Quando l'apparato non sembra funzionare normalmente o quando esibisce un cambiamento di prestazioni o

E. Quando è caduto o il telaio è stato danneggiato

### 15. ASSISTENZA

L'utente non deve tentare di prestare assistenza all'apparato, se non per quanto esposto nelle istruzioni. Tutti gli altri interventi devono essere effettuati da un tecnico specializzato.

### 16. CARRELLI E STAND

L'apparato deve essere impiegato su carrelli o stand solo se questi sono sufficientemente solidi e stabili per la funzione a cui si vuole dedicarli.

La combinazione di carrello ed apparato deve essere mossa con cautela. Fermate e partenze improvvise, forze eccessive e superfici irregolari, possono ribaltare la combinazione carrello e apparato.



# TABLE OF CONTENTS

PERFORMANCE SPECIFICATIONS .....	i
SAFETY PRECAUTIONS .....	ii
INTRODUCTION .....	1
FRONT & REAR PANEL VIEW .....	2
<b>INSTALLATION</b>	
Location .....	3
AC Line .....	3
Input .....	4
<b>PC Board Layout</b> .....	Removable Center Spread
Output Connections .....	7
Monophonic Use .....	7
<b>OPERATION</b>	
Power Switch .....	7
Level Controls .....	7
Mono Switch .....	7
Short Circuit Protection .....	8
LED Indicators .....	8
Warm Up .....	8
Cleaning and Maintenance .....	8
<b>PC BOARD LAYOUT</b> .....	9
<b>PARTS LIST</b> .....	10
<b>TECHNICAL REFERENCE</b>	
Field Service Considerations .....	12
Theory and Operation of trans•nova .....	12
Circuit Operation .....	13
trans•nova Implementation .....	13
Output Short Protection .....	14
Thermal Protection .....	14
Clipping Indicator .....	15
Signal Present Indicator .....	15
Calibration .....	15
Bias .....	15
Common Mode Rejection .....	15
Module Replacement .....	16

# INTRODUCTION

The Hafler P1500 and P3000 are two channel professional power amplifiers. Passive cooling with large heatsinks is used for low mechanical noise. Our patented **trans•nova** circuit topology and MOSFET output stage ensures trouble free, long term operation and is backed by our five year warranty.

This manual contains information on using the P1500 and P3000 amplifiers. It is organized into three main sections. “**Installation**” covers the location and connection of the amplifier in the system. Like many precision components careful attention to the initial setup can yield dividends in higher performance and trouble-free use. “**Operation**” covers the controls and features of the amplifiers and how to use them to get the best effect. The “**Technical Reference**” section contains field service information. In addition to the schematic and parts list there are block diagrams and an explanation of circuit operation useful for technicians. We strongly urge reading over the Installation and Operation portions of this manual before putting the amplifier into service.

The circuitry used in the P1500 and P3000 is the latest refinement of our **trans•nova** (TRANScONductance Nodal Voltage Amplifier, US Patent 4,467,288) circuit. It has been proven to offer sound quality to satisfy the most analytic audiophile or the most demanding professional. The natural sound and realistic reproduction have made **trans•nova** amplifiers preferred in many critical installations. Since our pioneering use of MOSFETs in the DH-200 amplifier, they have proven extremely fault tolerant even in abusive situations. This sturdiness enables the amplifier to drive reactive speaker loads without the performance and sound penalties imposed by elaborate protection schemes.

Specialized circuits prevent damage to the amplifiers and speakers without affecting the audio signal. A soft start circuit prevents sending potentially destructive turn-on and turn-off transients to the speakers. A thermal sensing network monitors the heatsink temperature and shuts down the amplifier to protect from excessive operating heat. The need for internal fuses has been eliminated; a sensing circuit monitors the output and shuts down operation when it detects a short in the output load.

Each channel of these amplifiers is built as a self-contained module which only requires mounting the heatsink and connection to the chassis-mounted transformer and binding posts to be fully functional. The circuit board contains all the operational components. This modular arrangement simplifies construction and improves service accessibility. The circuit board assembly makes extensive use of surface mount components in the low power portion of the audio circuitry. Automated equipment is used to place and solder the components which yields greater uniformity and reliability.

The front panel has controls for input level adjustment and the power switch. In addition, LED indicators give a visual representation of the operating status of each channel. The THERMAL and SHORT indicators light to show when these protection circuits have been activated. The CLIP indicator helps prevent damaging the speakers by showing when the amplifier is overdriven. The SIGNAL indicator lights to show the presence of an audio signal.

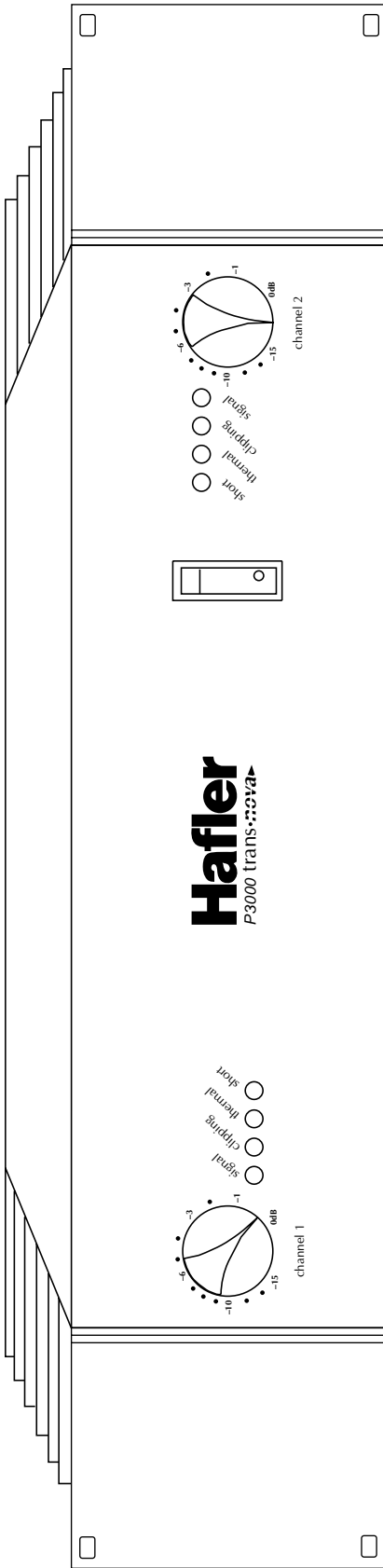

## Front Panel View

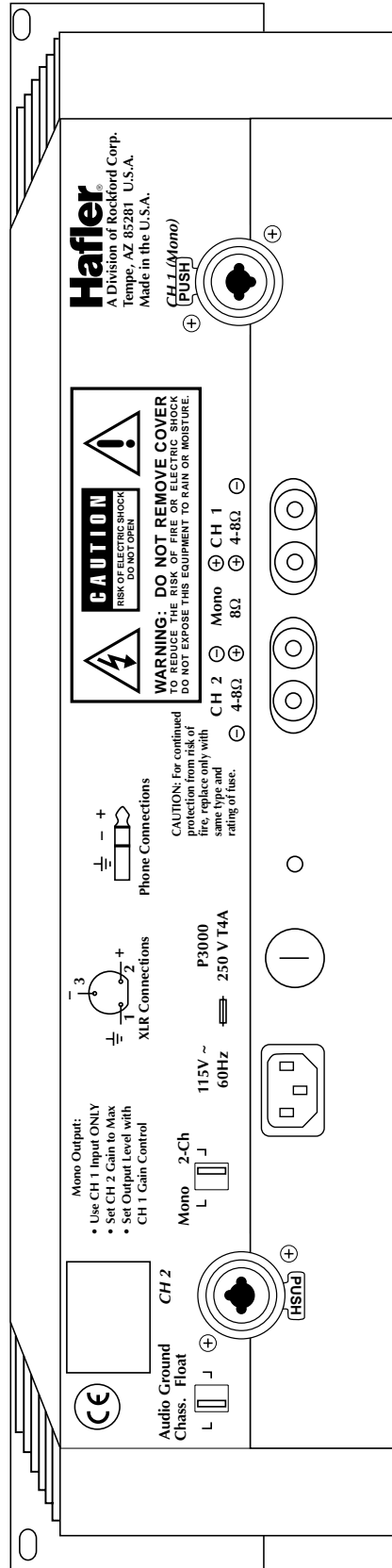

## Rear Panel View

# INSTALLATION

## LOCATION

The P1500 and P3000 power transformer can generate a substantial magnetic field, so caution should be exercised in the placement of low level components such as a tape deck, mixer or mic preamp to avoid inducing noise in the low level circuitry. The amplifiers can also produce considerable heat in normal operation so the primary consideration when determining a location for the amplifiers is to allow for adequate ventilation. The large heatsinks provide unrestricted airflow, but care must be taken to keep the slots in the bottom panel and top cover clear. If the amplifier is mounted in an equipment rack, make sure adjacent equipment does not impede cool air flow.



Rack systems should have two fans 4" to 5" in from the front of the amplifier blowing upward.

Inadequate ventilation can shorten component life, especially when other equipment raises the ambient air temperature, so circulating fans should be considered in tight quarters.

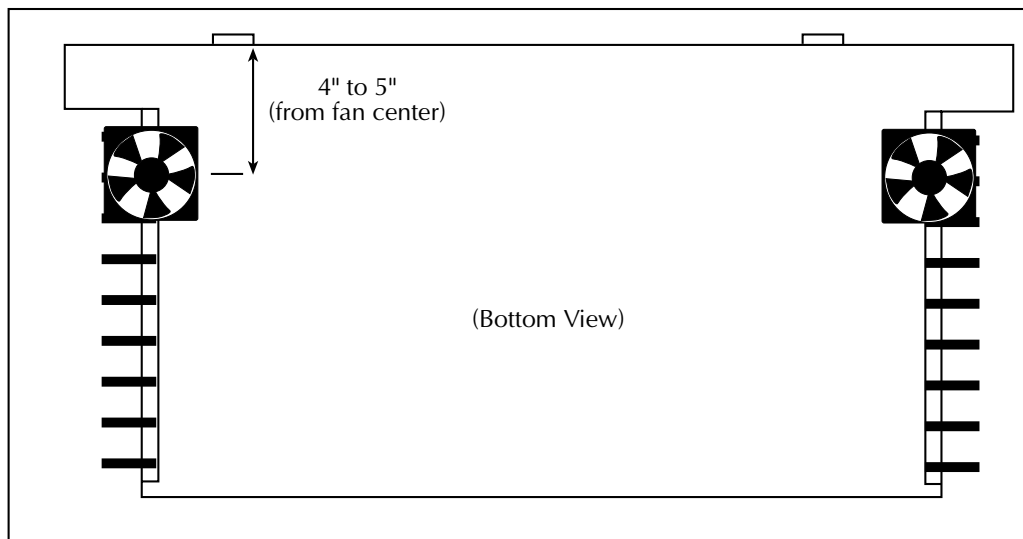

Fan center approximately in line with edge of unit and starting of heat sink fins

- Fans placed 4" to 5" from front of unit
- Fans placed under the unit pointing upwards
- Recommended P1500 fan is 32 CFM x 2
- Recommended P3000 fan is 100 CFM x 2

## AC LINE

The P1500U and P3000U operate from a 120 volt, 60Hz AC power line. The P1500CE and P3000CE operate from a 230 volt, 50-60Hz AC power line. Connection is made by a 16 gauge, IEC Type 320, grounded line cord. For safety considerations only a properly grounded (earthed) receptacle should be used. If a grounded circuit is not available do not break off the ground pin; use the proper adapter plug for a two wire receptacle. Mounted on the rear panel is the line fuse which interrupts the power to the amplifier. If this fuse blows replace it only with the same type and rating fuse. The correct replacement fuse value is printed on the rear panel of the amplifier. If the new fuse blows, this is an indication of a fault with the amplifier. Servicing should be performed only by a qualified technician.

## INPUT

The input jacks located on the back of the amplifier are dual function connectors which accept 1/4" Phone (Tip Ring Sleeve) or XLR plugs. The 1/4" Phone jack is connected according to conventional usage. The XLR jack is connected according to the IEC and AES standard.

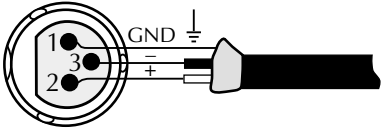
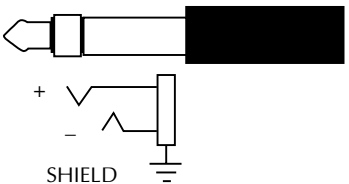
<p align="center"><b>XLR Balanced Input</b></p> <p align="center">Check output of source unit for proper signal polarity</p>	<p align="center"><b>1/4" TRS Balanced Input</b></p> <p align="center">Check output of source unit for proper signal polarity</p>
<p><b>INPUT</b>                      <b>FROM SOURCE</b></p> <p><b>Pin 1 = GND</b> <b>Pin 2 = (+)</b> <b>Pin 3 = (-)</b></p> 	<p><b>INPUT</b>                      <b>FROM SOURCE</b></p> <p><b>Tip = (+)</b> <b>Ring = (-)</b> <b>Sleeve = GND</b></p> 

Many popular mixers use unbalanced outputs and can be used with the Hafler amplifier. To minimize residual ground noise, we recommend using twisted pair cable or short cable lengths in this type of configuration.

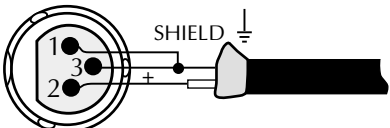
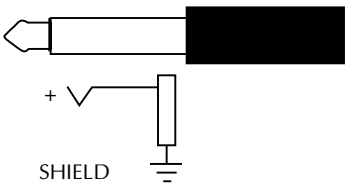
<p align="center"><b>XLR Unbalanced Input</b></p> <p align="center">Connect (-) and GND (shield) terminals at <i>both ends</i> of cable to prevent unstable amplifier operation</p>	<p align="center"><b>1/4" TRS Unbalanced Input</b></p>
<p><b>INPUT</b>                      <b>FROM SOURCE</b></p> <p><b>Pin 1 = GND</b> <b>Pin 2 = (+)</b> <b>Pin 3 = GND</b></p> 	<p><b>INPUT</b>                      <b>FROM SOURCE</b></p> <p><b>Tip = (+)</b> <b>Sleeve = GND</b></p> 

# SCHEMATIC DIAGRAM

P3000 shown. Ground switch in Chassis position, Mono switch in 2-Channel position.  
 P1500 differences shown on parts list.

- NOTES: UNLESS SPECIFIED OTHERWISE
1. ALL RESISTORS IN OHMS.
  2. ALL CAPACITORS IN MICROFARADS.
  3. CHANNEL 1 ONLY SHOWN.

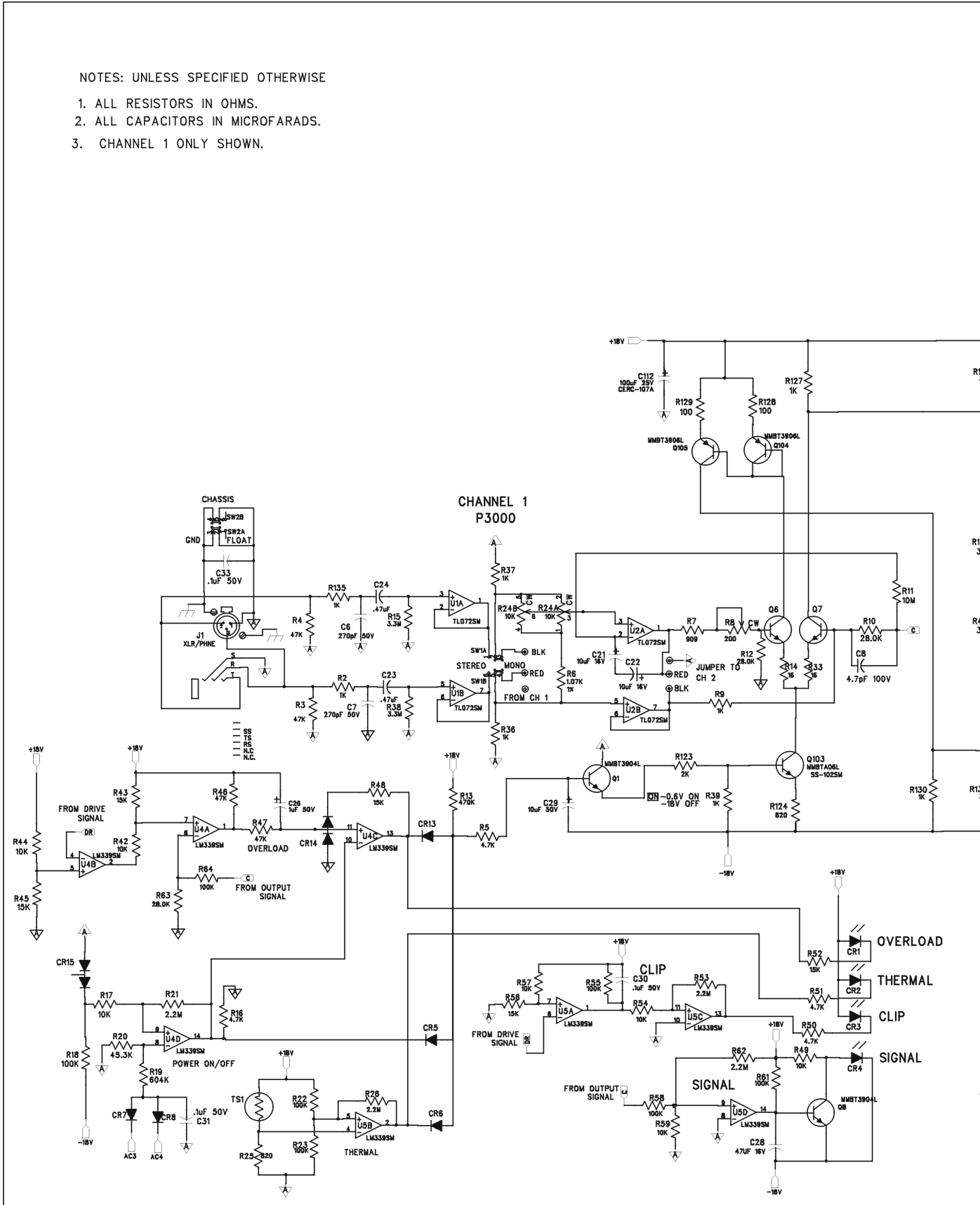

Removable Center Spread

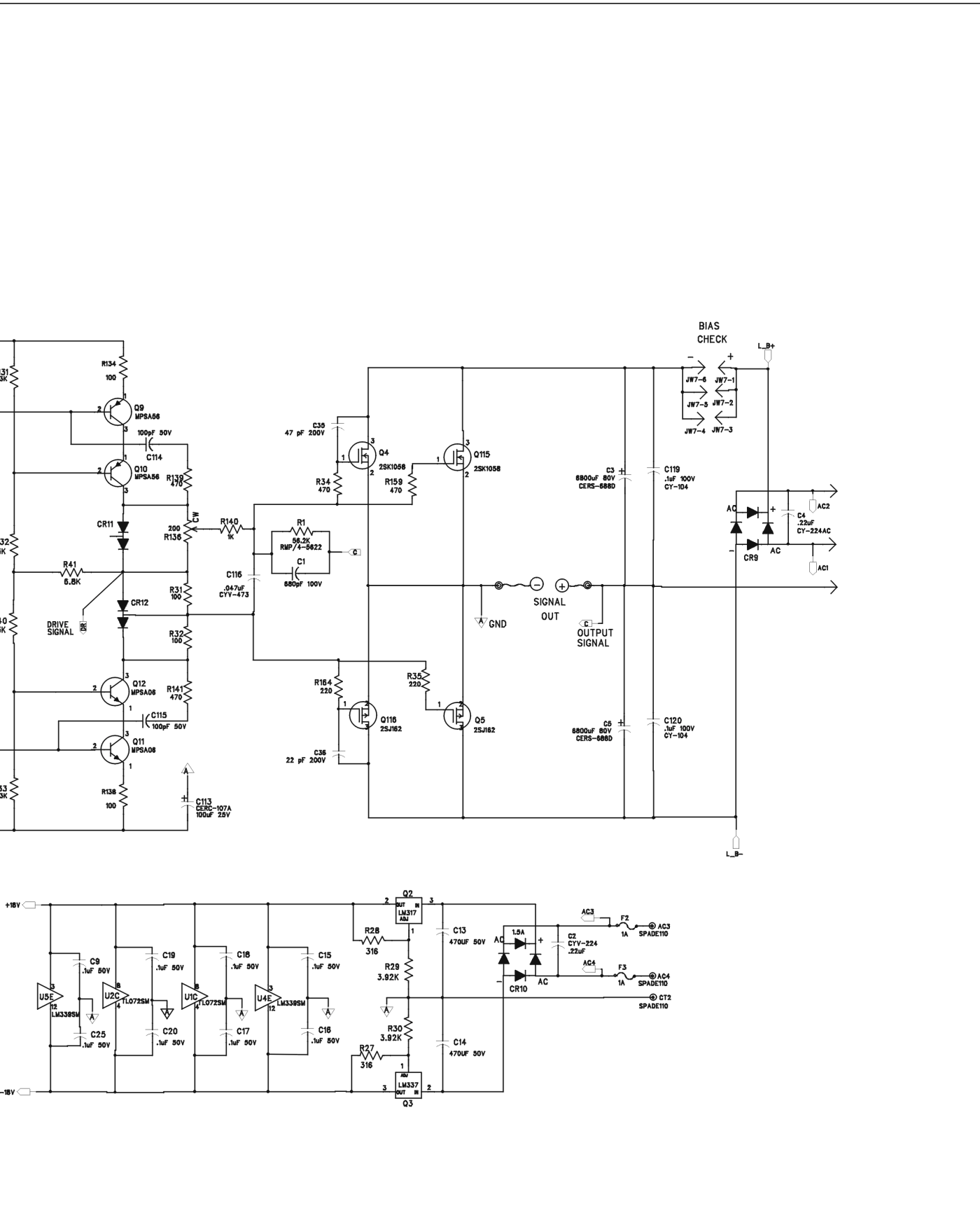

Removable Center Spread

## OUTPUT CONNECTIONS

The speaker output connectors are dual binding posts. These binding posts will directly accept 12 AWG wire or banana plugs and are spaced on 3/4" centers to accept dual banana plugs.

## MONOPHONIC USE

For systems with high power requirements, the amplifiers can be configured for single channel bridged mono operation. To bridge the amplifier, set the rear panel Mono/2 Channel switch to the Mono position. The Channel 1 input and level control is used and the Channel 2 level control must be set to its maximum gain position. The speaker is connected to the RED output binding posts.



When the amplifier is bridged the output is floating. Any speaker which requires a common ground from the amplifier output cannot be used in this application.



Since a bridged amplifier shares the load between the two channels, each channel will effectively drive half of the load. Therefore, for bridged mono operation we recommend using an eight ohm load as the minimum impedance.

# OPERATION

## POWER SWITCH

The POWER switch is located on the front panel of the amplifier. An internal lamp indicates when it is turned on.



Standard practice is to turn the amplifier on last and off first when switching components to prevent sending damaging transients to the speakers.

It is possible to leave the power switch in the on position and switch the amplifier remotely through a power distribution block or preamp switched outlet. When doing so make sure the switch is rated for the current required by the amplifier.

## LEVEL CONTROLS

The input sensitivity for each channel can be adjusted individually using the level controls on the front panel. The gain control on an amplifier is usually fully advanced to its maximum (rated) sensitivity. In public systems where it is necessary to match levels, the knobs can be removed and the controls adjusted with your fingers or a flathead screwdriver. Cover the holes with the enclosed plugs to restrict access.

## MONO SWITCH

Conventional two-channel stereo operation is obtained with the MONO/2 CH switch in the 2-Channel position. For high powered single channel use, switch to MONO and use the Channel 1 input and connect the speaker to the RED binding posts.



For thermal considerations we do not recommend using less than an eight ohm load on the amplifier when running it in mono.

When the switch is set in the mono position, the Channel 1 (+) and (-) inputs are connected to the Channel 2 in reversed polarity, which inverts the Channel 2 output. The gain is controlled by the Channel 1 level adjustment; set Channel 2 to maximum.



## SHORT CIRCUIT PROTECTION

Due to the self-protecting properties of the output power MOSFETs, there is no need for sonically degrading voltage and current limiting circuits. To protect the amplifier from problems which may occur in the speaker line there is an overload detection circuit.



In the event of a short in the speaker load or cables, the speaker detection circuit will shut down that channel and light the front panel SHORT indicator. If this happens, correct the fault and turn the amplifier off, then back on to reset.

## LED INDICATORS

Amplifier operation is monitored internally and each channel has four status LEDs. These indicators can be used for system troubleshooting in case of aberrant behavior.

- |                        |                                                                                                                                                                                                                    |
|------------------------|--------------------------------------------------------------------------------------------------------------------------------------------------------------------------------------------------------------------|
| <b><i>Signal</i></b>   | Monitors the amplifier output and lights when a signal is present. The SIGNAL indicator is calibrated to activate at an equivalent input voltage of 30mV.                                                          |
| <b><i>Clipping</i></b> | Monitors the DRIVE SIGNAL and lights when the drive signal voltage exceeds the maximum for linear operation of the output MOSFETs.                                                                                 |
| <b><i>Thermal</i></b>  | Indicates when the thermal protection has shut down the amplifier. This occurs when the heatsink temperature exceeds 90° C.                                                                                        |
| <b><i>Short</i></b>    | Indicates when the output overload monitor detects a potentially damaging short and shuts down amplifier operation. After clearing the fault, restore normal function by turning the amplifier off, then on again. |

## WARM UP

In order to achieve the best sonic performance from the amplifier, we recommend letting it warm up for 1 hour before beginning any critical listening. The amplifier may not deliver its full potential sound quality before this time has passed.

## CLEANING AND MAINTENANCE

There is no requirement for regular maintenance on the electronic components of the amplifier. If the case becomes soiled it can be cleaned using a soft cloth and a mild detergent, such as spray window or glass cleaner. If the amplifier is located in a particularly dusty environment cleaning the inside with compressed air or vacuuming every 18 to 24 months is sufficient.

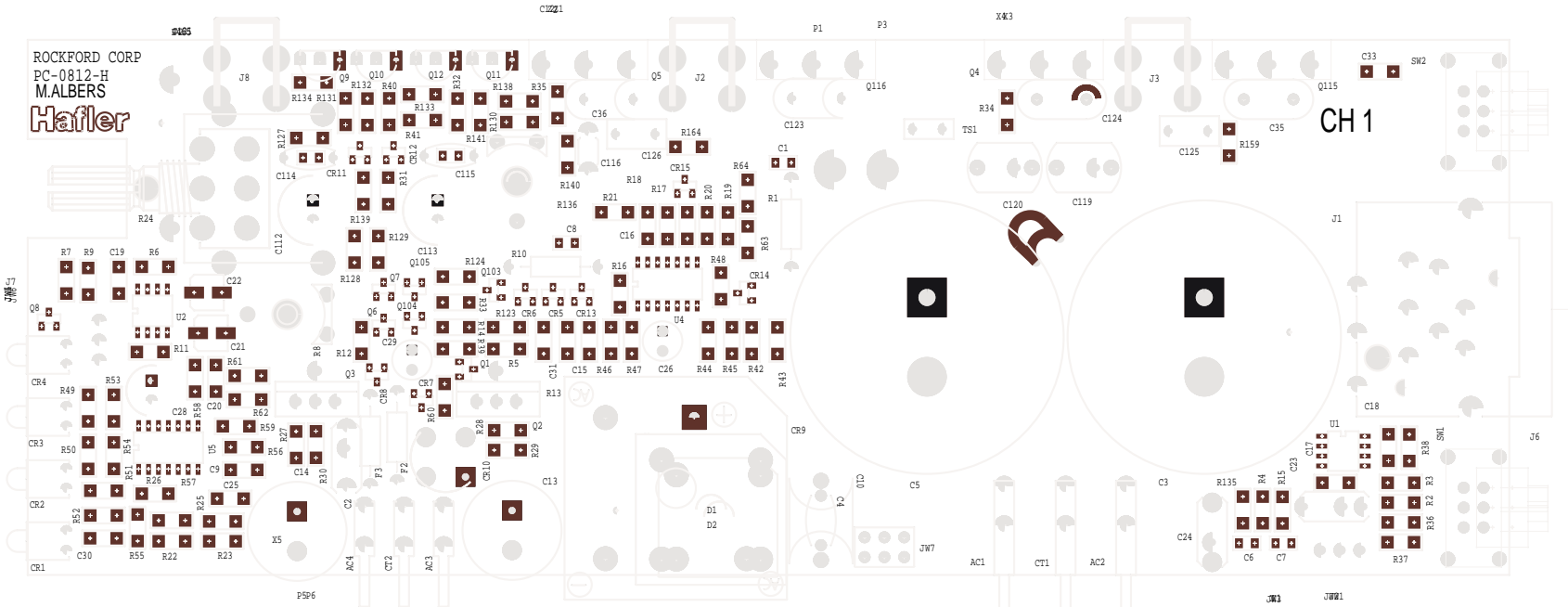





ARTWORK COMPONENT SIDE







revised 12/12/96

# PARTS LIST



P3000U 120VAC, 60Hz

DESIGNATOR	VALUE	PART #	DESIGNATOR	VALUE	PART #
ALL RESISTORS IN OHMS, 1/4W					
R1	56.2k	RMP/4-5622	R53	2.2M	RM/4-225C
R2	1k	RM/4-102C	R54	10k	RM/4-103C
R3	47k	RM/4-473C	R55	100k	RM/4-104C
R4	47k	RM/4-473C	R56	15k	RM/4-153C
R5	4.7k	RM/4-472C	R57	10k	RM/4-103C
R6	1.07k	RM/4-1071C	R58	100k	RM/4-104C
R7	909	RM/4-9090C	R59	10k	RM/4-103C
R8	200, Trim Pot	RVH-201	R61	100k	RM/4-104C
R9	1k	RM/4-102C	R62	2.2M	RM/4-225C
R10	28k	RMP/4-2802	R63	28k	RM/4-2802C
R11	10M	RMP/4-106C	R64	100k	RM/4-104C
R12	28k	RM/4-2802C	R123	2k	RM/4-202C
R13	470k	RM/4-474C	R124	820	RM/4-821C
R14	16	RM/4-160C	R127	1k	RM/4-102C
R15	3.3M	RM/4-335C	R128	100	RM/4-101C
R16	4.7k	RM/4-472C	R129	100	RM/4-101C
R17	10k	RM/4-103C	R130	1k	RM/4-102C
R18	100k	RM/4-104C	R131	3k	RM/4-302C
R19	604k	RM/4-6043C	R132	3k	RM/4-302C
R20	45.3k	RM/4-4532C	R133	3k	RM/4-302C
R21	2.2M	RM/4-225C	R134	100	RM/4-101C
R22	100k	RM/4-104C	R135	1k	RM/4-102C
R23	100k	RM/4-104C	R136	200, Trim Pot	RVH-201
R24	10k Pot	RV-0818	R138	100	RM/4-101C
R25	820	RM/4-821C	R139	470	RM/4-471C
R26	2.2M	RM/4-225C	R140	1k	RM/4-102C
R27	316	RM/4-3160C	R141	470	RM/4-471C
R28	316	RM/4-3160C	R159	470	RM/4-471C
R29	3.92k	RM/4-3921C	R164	220	RM/4-221C
R30	3.92k	RM/4-3921C			
R31	100	RM/4-101C	TS1	Thermistor	SS-1519-A
R32	100	RM/4-101C			
R33	16	RM/4-160C	SW1	DPDT Switch	SW-0280
R34	470	RM/4-471C			
R35	220	RM/4-221C	C1	680pF, 100V	CDS-681DBAA
R36	1k	RM/4-102C	C2	0.22μF, 50V	CYV-224
R37	1k	RM/4-102C	C3	6800μF, 80V	CERS-688D
R38	3.3M	RM/4-335C	C4	0.22μF, 250V	CY-224AC
R39	1k	RM/4-102C	C5	6800μF, 80V	CERS-688D
R40	3k	RM/4-302C	C6	270pF, 50V	CDS-271CAAA
R41	6.8k	RM/4-682C	C7	270pF, 50V	CDS-271CAAA
R42	10k	RM/4-103C	C8	4.7pF, 100V	CDS-047DBAA
R43	15k	RM/4-153C	C9	0.1μF, 50V	CDS-104CCDB
R44	10k	RM/4-103C	C13	470μF, 50V	CER-477C-024
R45	15k	RM/4-153C	C14	470μF, 50V	CER-477C-024
R46	47k	RM/4-473C	C15	0.1μF, 50V	CDS-104CCDB
R47	47k	RM/4-473C	C16	0.1μF, 50V	CDS-104CCDB
R48	15k	RM/4-153C	C17	0.1μF, 50V	CDS-104CCDB
R49	10k	RM/4-103C	C18	0.1μF, 50V	CDS-104CCDB
R50	4.7k	RM/4-472C	C19	0.1μF, 50V	CDS-104CCDB
R51	4.7k	RM/4-472C	C20	0.1μF, 50V	CDS-104CCDB
R52	15k	RM/4-153C			





DESIGNATOR	VALUE	PART #
C21	10µF, 16V	CER-106SM
C22	10µF, 16V	CER-106SM
C23	0.47µF, 50V	CYV-474
C24	0.47µF, 50V	CYV-474
C25	0.1µF, 50V	CDS-104CCDB
C26	1µF, 50V	CER-105C-024
C28	47µF, 16V	CER-476-024
C29	10µF, 50V	CER-106C-024
C30	0.1µF, 50V	CDS-104CCDB
C31	0.1µF, 50V	CDS-104CABB
C33	0.1µF, 50V	CDS-104CCDB
C35	47pF, 200V	CM-470-024
C36	22pF, 200V	CM-200-024
C112	100µF, 25V	CER-107A-024
C113	100µF, 25V	CER-107A-024
C114	100pF, 50V	CDS-101CAAA
C115	100pF, 50V	CDS-101CAAA
C116	0.047µF, 50V	CYV-473
C119	0.1µF, 100V	CY-104
C120	0.1µF, 100V	CY-104
Q1	MMBT3904LT1	SS-0792
Q2	LM-317	SS-239
Q3	LM-337	SS-240
Q4	2SK1058	SSH-741T
Q5	2SJ162	SSH-740T 
Q6	MMBT5088L	SS-0114 
Q7	MMBT5088L	SS-0114
Q8	MMBT3904LT1	SSS-0792
Q9	MPS-A56	SS-101A
Q10	MPS-A56	SS-101A
Q11	MPS-A06	SS-102A
Q12	MPS-A06	SS-102A
Q103	MMBTA06L	SS-102SM
Q104	MMBT3906LT1	SS-0791
Q105	MMBT3906LT1	SS-0791
Q115	2SK1058	SSH-741T
Q116	2SJ162	SSH-740T  
CR1	Red LED	SS-741
CR2	Red LED	SS-741
CR3	Red LED	SS-741
CR4	Green LED	SS-740
CR5	MMBD914L Diode	SS-803SM
CR6	MMBD914L Diode	SS-803SM
CR7	MMBD914L Diode	SS-803SM
CR8	MMBD914L Diode	SS-803SM
CR9	Bridge Rectifier 15A	SS-0801
CR10	Bridge Rectifier 1.5A	SS-0800 
CR11	BAV99L Dual Diode	SS-260SM
CR12	BAV99L Dual Diode	SS-260SM
CR13	MMBD914L Diode	SS-803SM

DESIGNATOR	VALUE	PART #
CR14	BAV99L Dual Diode	SS-260SM
CR15	BAV99L Dual Diode	SS-260SM
U1	TL072CD Dual Opamp	SS-143SM
U2	TL072CD Dual Opamp	SS-143SM
U4	LM339 Comparator	SS-730SM
U5	LM339 Comparator	SS-730SM
	Power Switch	SWH-1009 
	IEC Connector	CC-0852 
	IEC Line Cord	FAH-146
	Dual Binding Post	CC-0867
	P3000 Transformer	TT-1531 
F2	Fuse, 1A Fast	FS-1592 
F3	Fuse, 1A Fast	PS-1592 
Line Fuse	Fuse, 5A Slo Blo	FS-005SB 

#### Parts List Modifications for P1500CE

European Linecord	FA-1464 
Fuseholder Cup 5x20mm	FS-1125 
1.25A Slo Blo 5x20mm	FS-1474A 
230V Transformer	TT-1457B 



#### Parts List Modifications for P3000CE



European Linecord	FA-1464 
Fuseholder Cup 5x20mm	FS-1125 
2.5A Slo Blo 5x20mm	FS-1541A 
230V Transformer	TT-1532B 



#### Parts List Modifications for P1500U 120VAC, 60Hz



C3	3300µF, 63V	CERS-338E
C5	3300µF 63V	CERS-338E
C35, 36	Not Used	
CR9	Bridge Rectifier, 8A	SS-0799 
Q5, Q115	Not Used	
	P1500 Transformer	TT-1456 
Line Fuse	Fuse, 4A Slo Blo	FS-004SB 

 Components marked with this symbol are safety critical and should only be replaced with identical components.

 Los componentes marcados con el simbolo son  imprescindibles para la proteccion del equipo, por lo cual que solo sean reemplazados por los mismos componentes.

 Les composants marqués du symbole  sont indispensables à la sécurité et ne peuvent être remplacés qu'avec des composants identiques.

 Bauteile, die mit einem  gekennzeichnet sind, sind sehr wichtig und dürfen nur mit den original Ersatzteilen ausgetauscht werden.

 I componenti contrassegnati da  sono critici per la sicurezza e devono essere rimpiazzati solo con ricambi di valore identico.

# TECHNICAL REFERENCE

## FIELD SERVICE CONSIDERATIONS

A primary focus during the design and development of the P1500 and P3000 was to ensure the dependability of the amplifiers. The use of lateral MOSFET output transistors and the low voltage trans•nova input stage combined with careful component selection for the circuit assembly made the reliability goals achievable. However, a parallel effort was also undertaken to make sure any down time caused by an amplifier fault was minimized by making the amplifiers “technician friendly.” The modular construction allows for exchanging the entire operational portion of either channel quickly and easily. This section of the manual also contains circuit descriptions and block diagrams to assist technicians with component level repairs.

## THEORY AND OPERATION OF trans•nova

The (TRANsconductance NOdal Voltage Amplifier) principle is based on our 1984 U.S. Patent 4,467,288. This patent describes the advantages of audio power amplifiers in which a MOSFET output stage is connected in a grounded source configuration. In this connection the output stage has its full voltage gain of typically 20dB (ten times), instead of the usual 1dB loss of voltage follower designs.

It is an inevitable result of electrical physics that this output with gain inherently increases the power gain (for the same bandwidth) of the output stage by typically ten times over the conventional follower connection, using exactly the same MOSFET devices.

The output stage is thus now ten times less wasteful of its incoming drive power. The driver stage can now be of a low voltage ( $\pm 18$  volts) nature and be designed along the same principles always used in high quality preamplifiers: Class A operation, high linearity, and wide bandwidth. A topology utilizing an output stage with gain yields a much simpler, shorter total signal path than that of the usual high voltage driver designs. The number of serial stages is reduced from five or more, to only three.

But all of the above does not make an amplifier trans•nova. The output stage is further refined into a trans-impedance stage (current-to-voltage converter), to achieve extremely short loop (fast) negative feedback. The output stage is driven cooperatively by a transconductance stage (voltage-to-current converter).

The P1500 and P3000 are the most affordable amplifiers we have yet developed utilizing the basic trans•nova principle. And, although the measured specifications are very good, the numbers do not describe the realistic sound of the amplifiers.

## CIRCUIT OPERATION

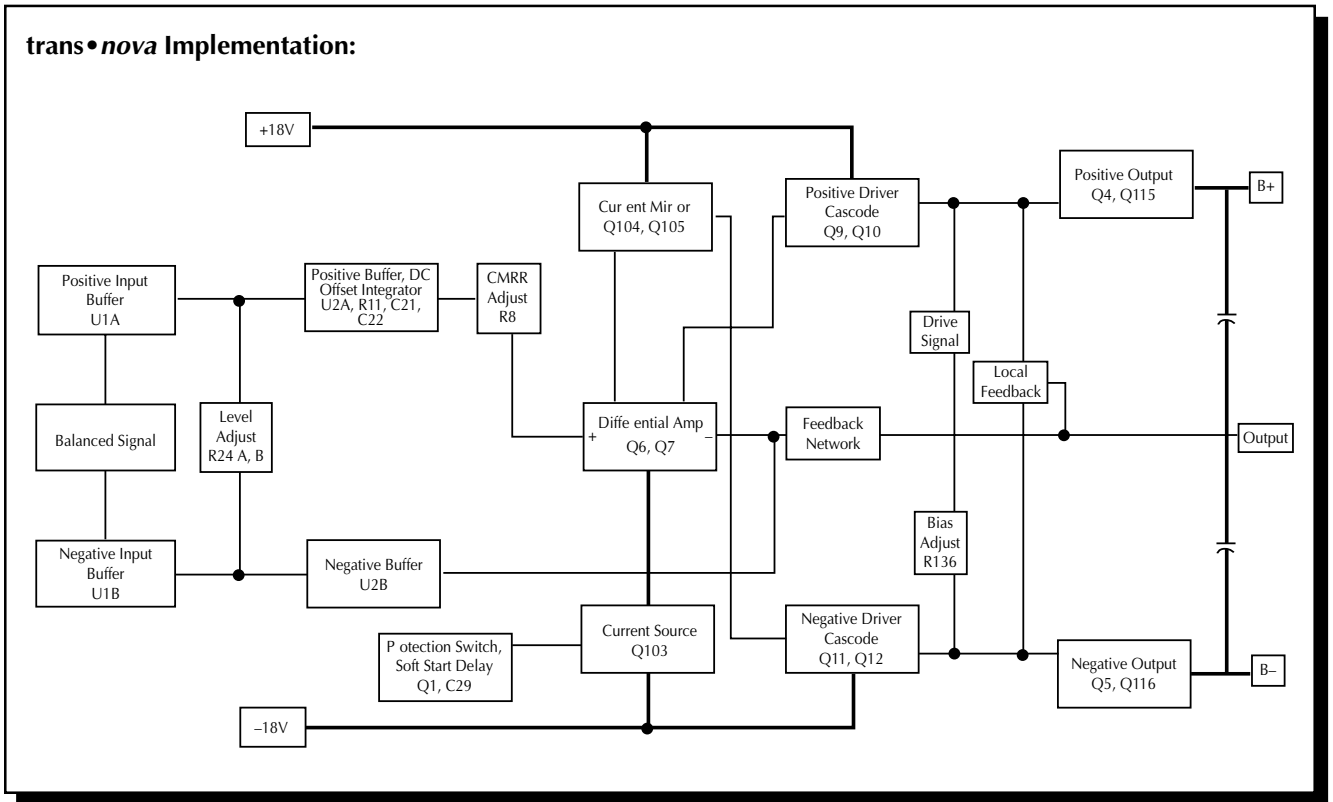

The transistor Q1 is configured to operate as a switch which controls the current source, Q103, of the input differential amp, Q6 and Q7. When Q1 is off, the emitter voltage is low turning off Q103. Timing of the Soft Start function is controlled by the charging time of C29. Operation of Q1 is controlled by the THERMAL and SHORT protection circuits. U1A and U1B are buffer amps configured as unity gain followers which feed the resistive network comprised of R24A, R24B and R6 which attenuates the differential input at U2A and U2B. The output of U2A and U2B is taken to the inputs of the differential amp Q6 and Q7, U2A is also configured as a DC servo integrator to null the input offset currents. Transistor Q6 is the non-inverting input of the differential amp, taking the signal from U2A, the output is taken through the current mirror, Q105 and Q104 where the signal is inverted, then feeds the negative driver Q11 and Q12. Transistor Q7 is the inverting input of the differential amp, taking the signal from U2B. This output feeds the positive driver Q9 and Q10. The positive drivers Q9 and Q10, and the negative drivers Q11 and Q12 are cascoded stages which supply drive current and voltage to the output devices. Class AB bias current is controlled by R136. The network R1 and C1 form the short loop feedback for the output stage. Global feedback is supplied by the network R10 and C8.

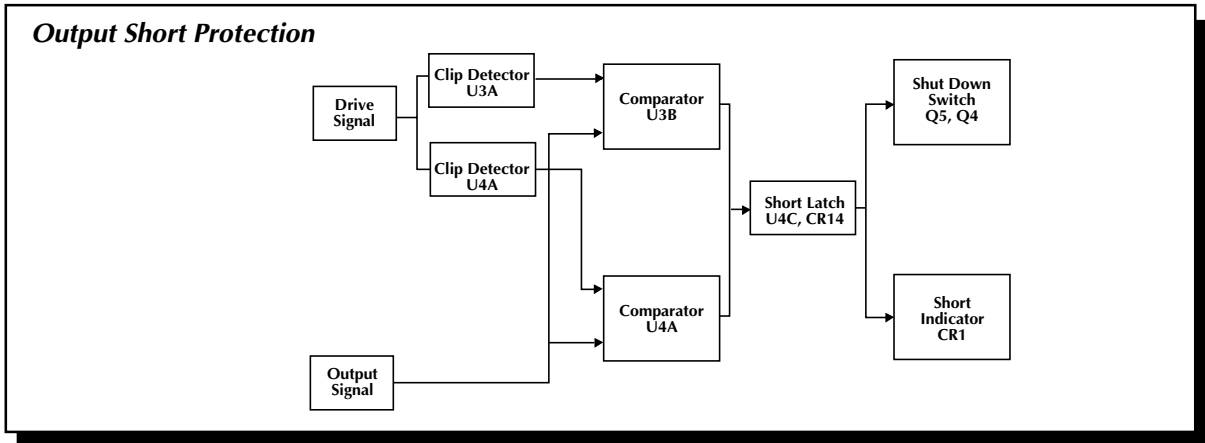

The Short detector monitors the Drive Signal and Output Signal levels and shuts down that channel when a shorted output condition is detected. Recovering from the Short protection requires turning the amplifier off to reset. The comparator U4B monitors the Drive Signal and goes low when the drive level is sufficient to clip the output stage. This drive signal clip status is connected to the input of U4A on pin 7, the Output Signal is connected to the input of U4A on pin 6. The output of U4A goes low when pin 7 is low and pin 6 is near zero. This condition, indicating high drive voltage and low output voltage, occurs only when the output is shorted. If the output of U4A is low for the time sufficient for C26 to charge, then U4C latches low activating the protection switch Q1 and lighting the indicator CR1. The output of U4C is held low by CR14 and will reset only after the power is turned off.

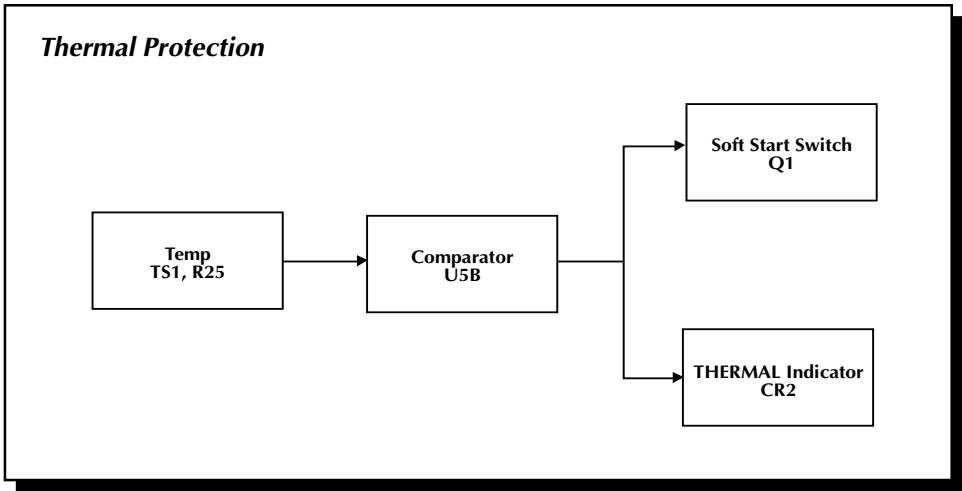

The Thermal protection is activated, and shuts down audio operation when the amplifier heatsink reaches 90° C. The voltage divider R22 and R23 establishes the reference voltage on pin 5 of U5B. The control voltage on pin 4 is established by the voltage divider TS1 and R25. TS1 is a NTC (Negative Temperature Coefficient) thermistor mounted on the heatsink. As TS1 warms and the resistance falls, the voltage on pin 4 rises. When the voltage on pin 4 exceeds the voltage on pin 5, the output on pin 2 goes low activating the protection switch Q1 and lighting the THERMAL indicator.

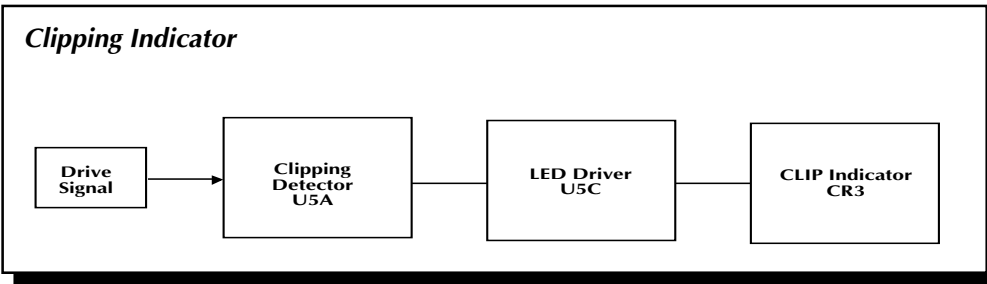

The CLIP indicator is driven by the buffer U5C which is controlled by the comparator U5A. The voltage divider R56 and R57 establishes the reference voltage for the Clipping detector at pin 7 of U5A. The reference voltage scales the output of U5A to indicate when the Drive Signal at pin 6 demands in excess of the available voltage or current of the output stage. The output of U5A is stretched by R55 and C30 to prevent the CLIP indicator CR3 from flickering. Hysteresis is applied to the LED driver U5C by R53 to stabilize the output during input transitions.

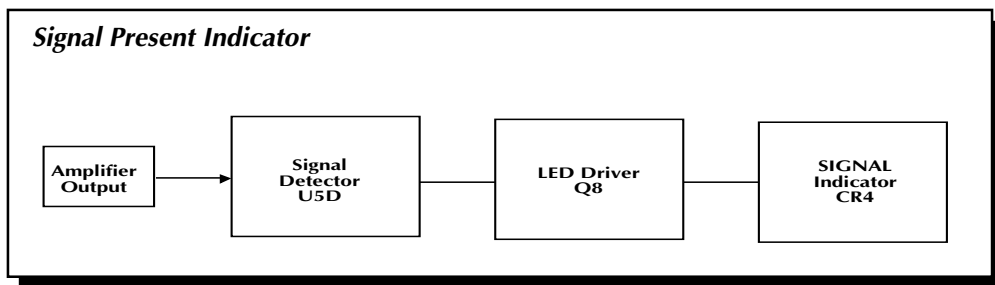

The SIGNAL indicator is controlled by the comparator U5D and the transistor Q8. The amplifier output is connected to the input pin 9. The voltage divider R58 and R59 scales the output voltage to change the comparator output state at an equivalent input voltage of 30mV, with the level controls set for full gain. The output at pin 14 controls the transistor Q8 to shunt across and turn off the LED CR4.

## CALIBRATION

**⚠ WARNING: Only a competent technician should attempt the following procedure.**

### **Bias:**

The bias control establishes the quiescent Class AB output current of the amplifier. The bias should not need readjustment from the factory setting; however, if the amplifier is repaired and output devices have been changed, or if the two channels of the amplifier do not run at the same temperature, calibrating the bias is necessary. **Disconnect the power to the amplifier before removing the cover.** To adjust the bias, disconnect the input and speakers and remove the jumper JW7. Connect an amp meter across the exposed pins. Adjust R136 to get a current reading of 100 mA for the P1500, 200 mA for the P3000.

**⚠ WARNING: Only a competent technician should attempt the following procedure.**

### **Common Mode Rejection:**

The input common mode null is adjusted by the trim pot R8. The CMRR should be greater than 75dB below rated output. If the CMRR requires adjustment, feed the amplifier input with a common mode signal and adjust R8. **Disconnect the power to the amplifier before removing the cover.** Use a sinewave generator set to 1 volt output at 1kHz. Connect the generator signal output to the tip and ring of a 1/4" plug and ground to the sleeve. Plug this into the amplifier input. Connect an AC voltmeter to the amplifier output binding posts. Adjust R8 to give the lowest voltage output from the



amplifier. For a temporary adjustment when a signal generator and voltmeter are not available, use an FM tuner and tune it to an unused station as your signal source, and connect the output to the amplifier as described above. Connect the amplifier output to a small full range speaker. Turn the amplifier level controls full down and turn the amplifier on. Turn up the level control until you hear a signal through the speaker. Alternate adjusting R8 and the input control until you have the level control full. There should be a very low output from the amplifier if any is detected at all.

**MODULE REPLACEMENT**



**WARNING: Only a competent technician should attempt the following procedure.**

The amplifier modules have been designed to eliminate the need for a special work place if a field exchange becomes necessary. All wire connections are made by quick connect terminals. The following tools are needed:

- Allen wrench, long reach 9/64
- Allen wrench, long reach 7/64
- Phillips screwdriver #1 tip
- Thin nose pliers

Remove the Phillips head screws located on the rear panel, which secure the input jacks. Remove the two 9/64 Allen screws located between the heatsink fins along the top edge on each side, which fasten the cover. Three more screws hold the heatsink to the chassis; remove these screws and the level control knob. Unplug the gray cable which connects the mono input signal to Channel 2. Tilt the rear of the heatsink up and disengage the assembly from the chassis. Pull the heatsink away from the chassis to extend the wires. Disconnect the output wires from the binding posts and the power wires from the module. Remove the module from the heatsink.

Install the new module on the heatsink. If it is Channel 1, set the Ground and Mono switches to the left (looking from the rear of the module) and reattach the gray mono cable. To reduce the chance of assembly errors in high stress situations, the main AC terminals are sized to accommodate only the correct wires. Reconnect the wires to the terminals as follows:

Wire Color	Function	Terminal/Size
Red	Output	Red Binding Post, 1/4"
Black	Output Ground	Black Binding Post, 1/4"
Orange (two)	High Voltage AC	AC1, AC2, 1/4"
White/Orange	High Voltage Center Tap	CT1, 1/4"
Blue (two)	Low Voltage AC	AC3, AC4, 1/8"
White/Blue	Low Voltage Center Tap	CT2, 1/8"

# SERVICE POLICY AND LIMITED WARRANTY

Rockford Corporation (Hafler Division) offers a limited warranty on Hafler products on the following terms:

- **Length of Warranty**

- 5 years on P1000, P1500, P3000, P4000
- 7 years on P9505 and P7000
- 90 days on all B-Stock (receipts are required)

- **What is Covered**

This warranty applies only to products sold to the original owner (non-transferable). This only applies to units sold in the Continental United States. You are required to have a copy of the receipt stating the customer's name, dealer name, product purchased and date of purchase.

- **Products found to be defective during the warranty period** will be repaired or replaced (with product deemed to be equivalent) at Hafler's discretion.

- **What is NOT Covered**

1. Damage caused by accident, abuse, improper operations, water, theft
2. Service performed by anyone other than Hafler or an Authorized Hafler service center
3. Any product purchased outside the United States (please contact your local dealer)
4. Shipping charges to get the unit to Hafler
5. Any product which has had the serial number defaced, altered, or removed

- **Limit on Implied Warranties**

Any implied warranties including warranties of fitness for use and merchantability are limited in duration to the period of the express warranty set forth above. Some states do not allow limitations on the length of an implied warranty, so this limitation may not apply. No person is authorized to assume for Hafler any other liability in connection with the sale of the product.

- **How to obtain service or technical support**

Please call 1-800-669-9899 for Rockford/Hafler support. You must obtain an RA # (return authorization number) to return any products to Hafler. You are responsible for shipment of product to Hafler.

Rockford Corporation  
Hafler Division  
2055 E. 5th Street  
Tempe, Arizona 85281

# NOTES



HAFLER

A DIVISION OF

ROCKFORD CORPROATION

546 SOUTH ROCKFORD DRIVE

TEMPE, ARIZONA 85281 U.S.A.

480-967-3565 / 1-888-HAFLER1

[WWW.HAFLER.COM](http://WWW.HAFLER.COM)