

AVR15

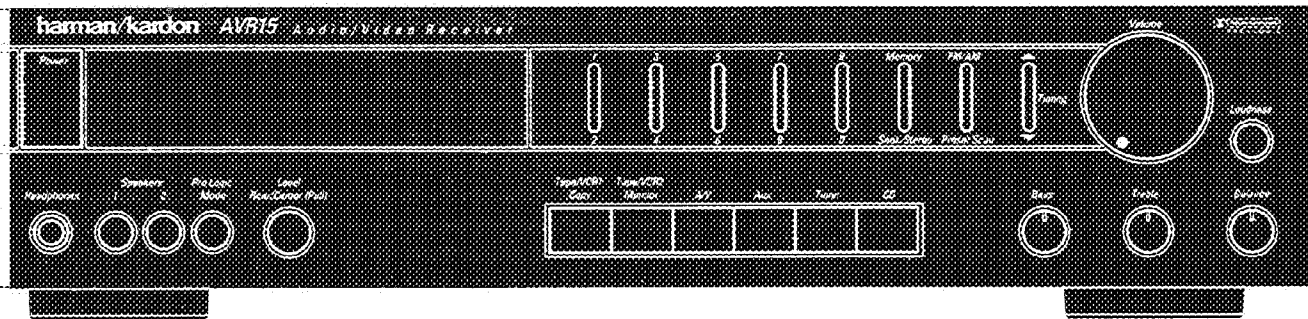

harman/kardon

Audio/Video Receiver

OWNER'S MANUAL

OWNER'S MANUAL

English

Pages 1 – 10

MANUEL D'UTILISATION

Français

Pages 11 – 20

BEDIENUNGSANLEITUNG

Deutsch

Seiten 21 – 30

MANUALE DI ISTRUZIONI

Italiano

Pagine 31 – 40

MANUAL DE INSTRUCCIONES

Español

Páginas 41 – 50

For Customers in the UK

Your unit is supplied with the flex which will have either two or three wires, so the following items should be observed to guarantee safety:

THREE CORE FLEX

WARNING: THIS APPARATUS MUST BE EARTHED.

IMPORTANT. The wires in this mains lead are coloured in accordance with the following code:

Green-and-yellow	: Earth
Blue	: Neutral
Brown	: Live

As the colours of the wires in the mains lead of this apparatus may not correspond with the coloured markings identifying the terminals in your plug, proceed as follows:

The wire which is coloured green-and-yellow must be connected to the terminal in the plug which is marked by the letter E or by the safety earth symbol  or coloured green or green-and-yellow.

The wire which is coloured blue must be connected to the terminal which is marked with the letter N or coloured black.

The wire which is coloured brown must be connected to the terminal which is marked with the letter L or coloured red.

TWO CORE FLEX

IMPORTANT. The wires in this mains lead are coloured in accordance with the following code:

Blue	: Neutral
Brown	: Live

As the colours of the wires in the mains lead of this apparatus may not correspond with the coloured markings identifying the terminals in your plug, proceed as follows:

The wire which is coloured blue must be connected to the terminal which is marked with the letter N or coloured black.

The wire which is coloured brown must be connected to the terminal which is marked with the letter L or coloured red.



AVR15 OWNER'S MANUAL

Congratulations on your choice of the Harman Kardon AVR15 Audio/Video Receiver.

In order to obtain the best performance from this receiver, please be sure to read this owner's manual and use the AVR15 only in accordance with its instructions.

The special features of this unit include:

Dolby* Pro Logic Surround

The AVR15 Dolby Pro Logic decoding system brings the theater surround sound experience to your home. Dolby Pro Logic creates three channel surround sound plus a true center channel. Because of this center channel, listeners in less than ideal positions will still hear the movie dialogue coming from the screen.

HCC (High Instantaneous Current Capability)

The AVR15 amplifier sections react rapidly to musical transients, providing the instantaneous current necessary to precisely drive and control nearly any loudspeaker system.

Ultrawide Bandwidth

The bandwidth of this unit is exceptionally wide and is independent of negative feedback. This improves transient accuracy and phase linearity.

Low Negative Feedback

This unit has been designed to have low distortion and wide bandwidth without high negative feedback. This further improves its dynamic accuracy.

Discrete Component Circuitry

In order to achieve the above goals, all discrete electronic circuitry has been employed. No available integrated circuits could provide this high level of performance.

Sophisticated Electronic Protection Circuitry

Harman Kardon's unique protection circuitry guards the amplifier from short-circuited or damaged speakers and wires, without impairing sound quality by the use of current limiting or output relays.

GENERAL INSTRUCTIONS

Use the Correct AC Voltage

Connecting the unit to an outlet supplying a higher voltage may create a fire hazard.

Handle the Power Cord Gently

Do not disconnect the plug from the AC outlet by pulling the cord; always pull the plug itself. Pulling the cord may damage it.

If you do not intend to use your unit for any considerable length of time, disconnect the plug from the AC outlet. Do not place furniture or other heavy objects on the cord, and try to avoid dropping heavy objects upon it. Also do not make a knot in the power cord. Not only may the cord be damaged, it can also cause a short circuit with a consequent fire hazard.

Place of Installation

Place the unit on a firm and level surface. Avoid installing your unit under the following conditions:

- Moist or humid places.
- Places exposed to direct sunlight or close to heating equipment.
- Extremely cold locations.
- Places subject to excessive vibration or dust.
- Poorly ventilated places.

Do not obstruct the ventilation slots on the top surface of the unit by placing objects over them. Otherwise, the temperature inside the unit may rise, possibly affecting its long-term reliability.

In Case of Moving the Unit

Before moving the unit, be sure to pull out the power cord from the AC outlet and disconnect the interconnection cords with other units.

Do Not Open the Cabinet

To prevent shock hazard, do not tamper with internal components for inspection or maintenance. Harman Kardon does not guarantee against performance degradation resulting from any modification. If water, a hairpin or wire accidentally enters the unit, immediately extract the plug from the AC outlet to prevent shock and consult an authorized Harman Kardon service station. If you use the unit under this condition, it may cause a fire or shock hazard.

Cleaning

If the unit gets dirty, wipe it with a soft dry cloth. If necessary, wipe it with a soft cloth dampened with mild soapy water and then with a dry cloth. Never use benzene, thinner, alcohol or other volatile agent, and avoid spraying an insecticide near the unit.

* Manufactured under license from Dolby Laboratories Licensing Corporation.
"Dolby", "Pro Logic" and the double-D symbol  are trademarks of Dolby Laboratories Licensing Corporation.

CONNECTIONS

Packaging

Save all packing material. It is essential for shipping should you move, or in the event the unit ever needs repair.

AC Power

Plug the cord into a wall socket.

NOTE: The power does not shut off completely by just turning the power off. So power cord should be removed from AC outlet when not in use for a prolonged time.

Connecting Other Components

1. Make sure receiver and other components are turned off.
2. Connect each component's Output jacks to the corresponding Input jacks on the back of your receiver. Use the white, black or gray plugs to connect Left channel jacks; use the red plugs for Right jacks.

Connecting Antennas

Choosing an FM antenna.

Select the antenna that best meets your needs:

1. An indoor antenna is supplied with your receiver. This will work well if you are located in a strong signal area.
2. Other indoor antennas are available which may improve reception by offering greater positioning flexibility.
3. If reception is unsatisfactory using indoor antennas, an outdoor antenna should be installed.
4. Alternatively, you may connect to an FM cable antenna, if available.

Connecting an AM Antenna.

Your receiver comes with an AM loop antenna which provides good reception in most locations. For best results, place this antenna away from the unit and away from contact with any metal object. In areas where AM signals are weak, an outdoor AM antenna may improve sound quality.

Connecting Speakers

1. For best performance, use high quality speaker cables. However, ordinary copper wire can be used if the gauge meets the following requirements:

Wire Length	Gauge
Up to 2.5 meter	18 AWG
Up to 4 meter	16 AWG
Up to 6 meter	14 AWG
Over 6 meter	10-12 AWG custom speaker cable

2. Avoid coiling excess wire with or near line level hook-up cords.

IMPORTANT: When connecting two pairs of Front Left and Right speakers, determine the impedance of each pair by looking on the back of the speakers, or in your owner's manual, or by contacting your dealer or manufacturer. Then refer to the following chart to see if both sets may be played simultaneously.

If impedance of the two pairs is:	Can both pairs be played simultaneously?
8Ω/8Ω	YES
8Ω/6Ω	NO
8Ω/4Ω	NO
6Ω/6Ω	NO
6Ω/4Ω	NO
4Ω/4Ω	NO

WARNING: Do not play both sets of speakers simultaneously except as recommended above. Receiver may overheat.

Wired Remote Control

To control your receiver with an external infrared remote sensor, connect the wire from the remote sensor to the REMOTE IN jack on the back panel. Or, if another stereo component has a built-in infrared remote sensor and a Remote Output jack, it may be possible to connect this jack to the REMOTE IN jack of your receiver. All Harman Kardon products with "Remote In" and "Remote Out" jacks are compatible with one another, except for the Citation 22, 24 and 25. Other manufacturers' remote sensors and components may not be compatible, but it will not hurt to experiment. A second wire may be used to connect your receiver's REMOTE OUT jack to the Remote Input of another stereo component. Continue this process to include additional components (if compatible).

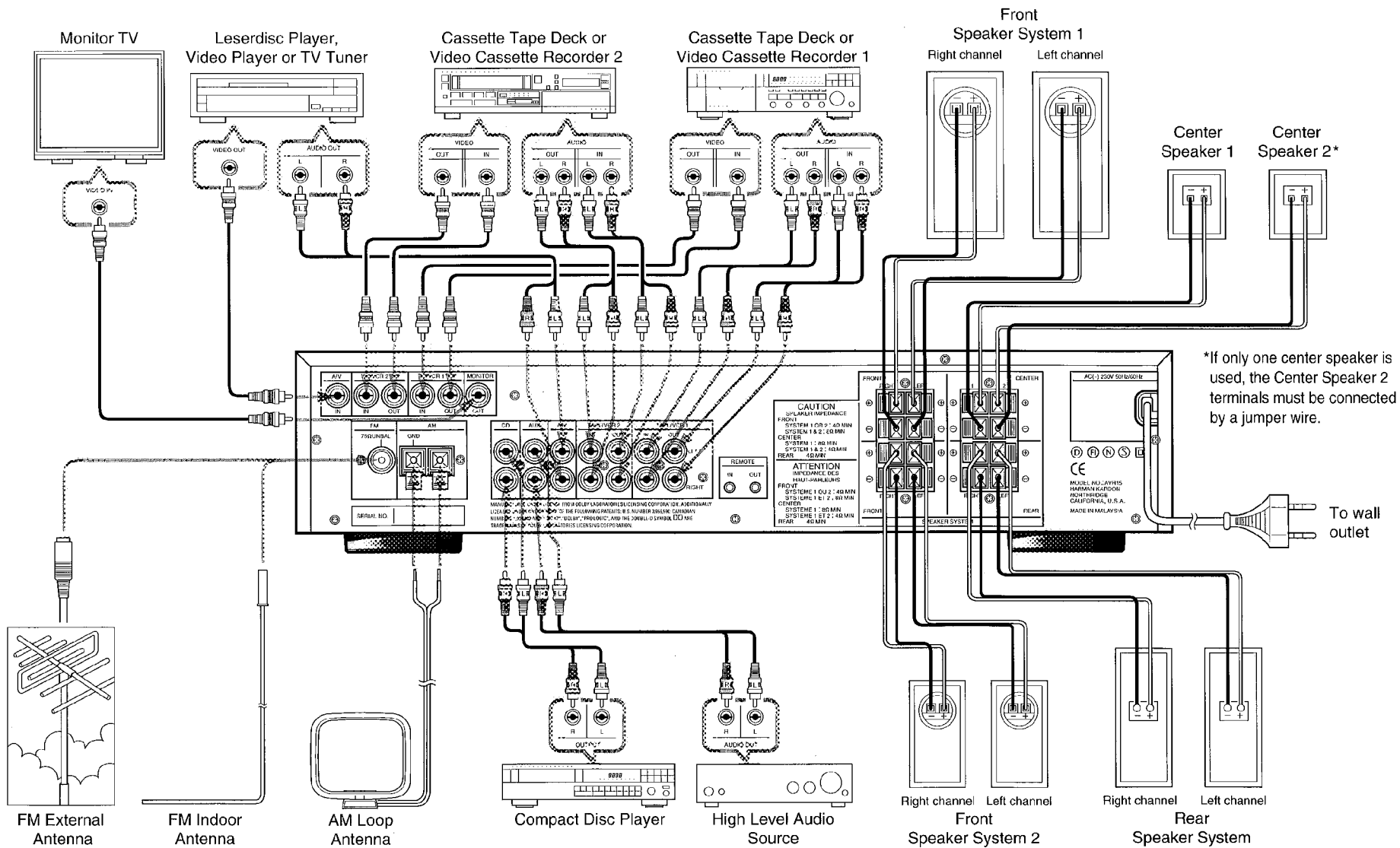

*If only one center speaker is used, the Center Speaker 2 terminals must be connected by a jumper wire.

CONTROLS and FUNCTIONS

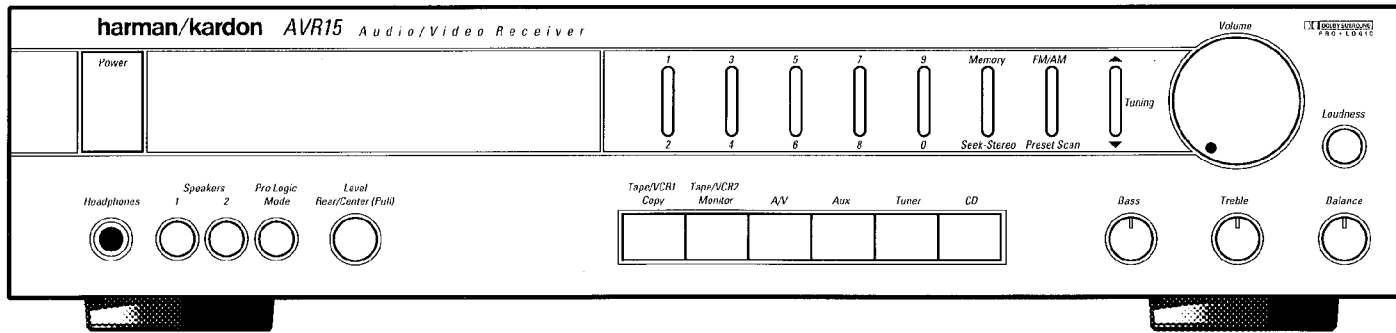

Power Switch

Press to turn the unit on and off.

Headphone Jack

Plug in headphones if desired. (With both Speakers 1 and 2 switches in Off position, output is supplied only to headphones.)

Speakers Switches

Push in to select either of two sets of speakers, or both, or neither (headphone output only).

Pro Logic Mode Button

Press to select the desired Pro Logic mode, or to return to Stereo (DIRECT) operation. (See page 8.)

Rear/Center Level Control

Turn to set the level of the rear speakers. Then pull the knob outward and turn to set the level of the center speaker(s).

Function Selector Buttons

Select desired input source by pressing the corresponding button.

Preset Buttons (1 – 0)

Press to access 30 pre-selected stations.

Memory Switch

Press to set a new preset station in memory.

Seek-Stereo Switch

Press to select Seek tuning in stereo, or manual tuning in mono.

FM/AM Selector Buttons

Press to select FM or AM reception.

Preset Scan Button

Press to continuously scan each of the 30 preset stations for 10 seconds.

Tuning Button

Press ▲ to tune to stations with higher frequencies; press ▼ for lower frequencies.

Bass Control

Turn to increase or decrease the proportion of low frequency sound.

Treble Control

Turn to increase or decrease the proportion of high frequency sound.

Balance Control

Turn to adjust relative output level of left and right speakers.

Volume Control

Turn to raise or lower output volume.

Loudness Switch

Press to improve sound quality when listening to your system at low volume.

DISPLAYS and REMOTE CONTROL

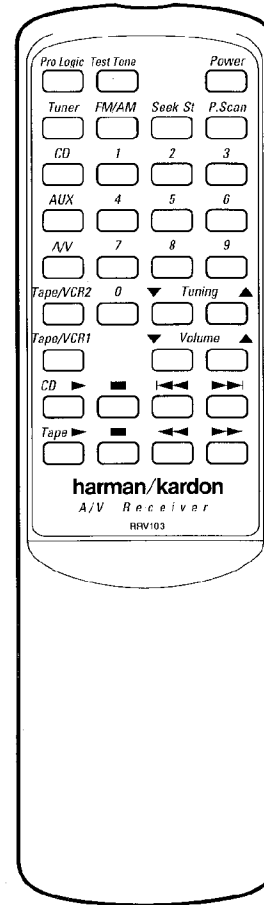
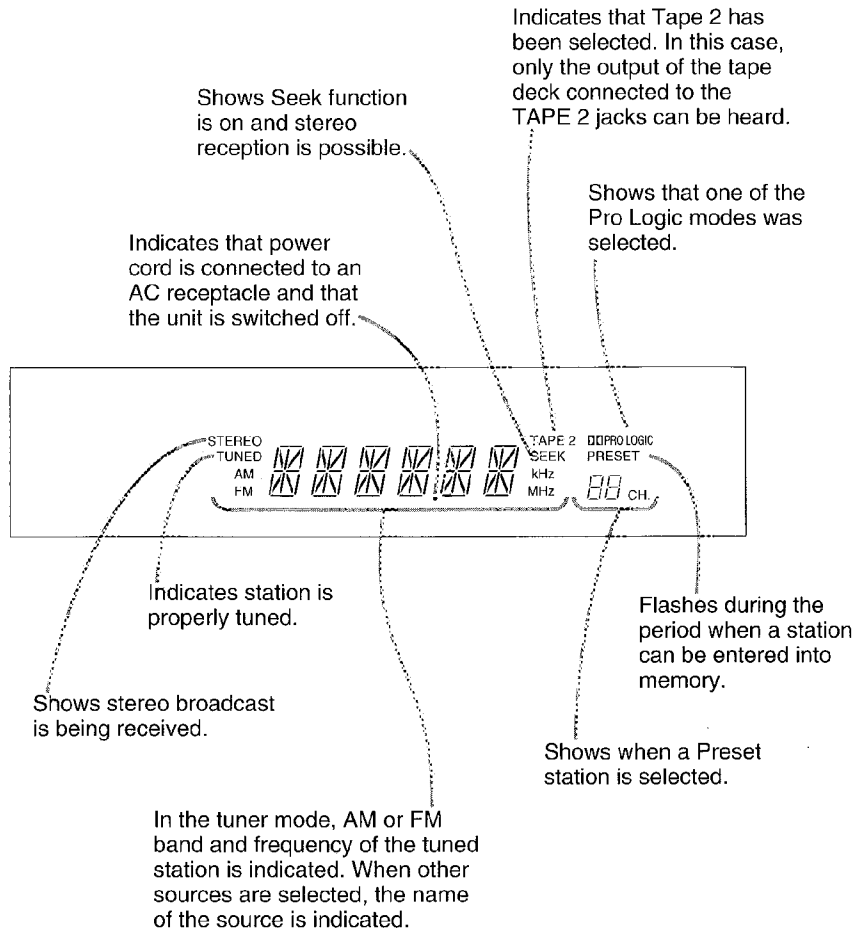

Independent Remote Control

The keys on the remote control unit function the same as the corresponding buttons on the receiver itself, except for the Test Tone button. For information on using the Test Tone button, see "Balancing the Speaker System" on page 8.

Operating Conditions

The control unit operates effectively within a distance of 7 meters and an angle of 30° from the receiver. Using the control near fluorescent lights may shorten this range, as will any dust or dirt that accumulates on the front of the remote control, or the remote sensor area of the receiver. Also avoid blocking the line of sight between receiver and remote.

The control unit is powered by two AA batteries, included with your receiver. When you replace weak batteries, replace both at the same time. When the remote is to be unused for an extended period, remove the batteries to prevent damage from corrosion.

OPERATING INSTRUCTIONS

Listening to your CD player, tape deck, or other component sound source.

1. Turn Volume control to minimum level and press the Power switch to turn on the receiver.
2. Set the Speakers switches to play speakers 1, 2, both or neither (for headphone use).
3. Press the Function selector button corresponding to the component you wish to hear.
4. Begin playing the desired components.
5. Adjust the Volume control to the desired level.
6. When listening at low volume, you may wish to press in the Loudness switch. This boosts low frequencies to improve the apparent balance of low to mid and high frequencies.
7. Adjust Bass, Treble and Balance controls as desired.
8. To turn off the Tape/VCR 1 selection, press either A/V, Aux, Tuner or CD button.

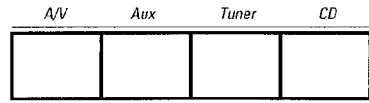

Listening to AM/FM broadcasts.

1. Turn Volume control to minimum level and press the Power switch to turn on the receiver.
2. Set the Speakers switches to play speakers 1, 2, both or neither (for headphone use).
3. Press the Function selector button marked "Tuner".
4. Select AM or FM by pressing the FM/AM selector.
5. Use the ▲ and ▼ Tuning buttons to tune to desired frequency. Or use the station Preset buttons as described below.
6. When tuning FM station:
 - Begin with the Seek-Stereo switch on. ("SEEK" will light on the display panel.) In this mode, pressing ▲ (or ▼) will tune your unit to the next higher (or lower) strong station.
 - To tune to stations too weak to be received in Seek-Stereo mode, turn Seek-Stereo switch off. Then use the ▲ and ▼ buttons to reach the desired frequency.

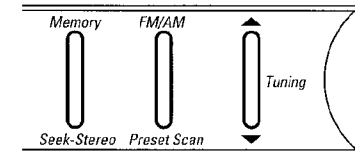

- NOTE: With Seek-Stereo off, all broadcasts are received in mono. (This eliminates the excessive noise that results when weak stations are received in stereo.) When you tune to a new, stronger station, be sure to turn Seek-Stereo back on.
7. Adjust the Volume control to the desired level.
 8. When listening at low volume, press in the Loudness switch. This boosts low frequencies to improve sound quality.
 9. Adjust Bass, Treble and Balance controls as desired.

Using the Preset Buttons

Your receiver allows you to store 30 station settings and quickly access them, using the 10 Preset buttons. The preset stations are designated by the number from 1 to 30. Any designation may be used for any AM or FM station, in whatever combination you choose.

To enter a station in memory:

1. Tune to the desired station.
2. Be sure the Seek-Stereo setting is the one desired*.
3. Press the Memory switch. ("PRESET" will flash for about 3 seconds.)
4. With "PRESET" flashing, press the desired numbered Preset button. If a preset of "10" or greater is to be entered, enter the 1, 2 or 3 for 10, 20 or 30 first, then within 3 seconds enter the last digit (0 – 9).

*NOTE: When a station is set in memory, the Seek-Stereo setting is also entered. Subsequently, each time a station is recalled using a Preset button, the tuner automatically switches to the original Seek-Stereo setting for that station.

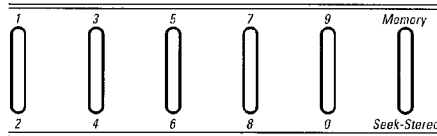

To change a preset station:

Simply enter the new station. The old station is automatically erased.

To access a preset station:

Press the desired numbered Preset buttons.

NOTE: Preset stations are stored indefinitely while the unit is connected to a live AC source, and for approximately 3 weeks when the unit is unplugged.

Making a Recording

When you select A/V, Aux, Tuner or CD as your sound source, recordings may be made on Tape/VCR 1 or 2, or both simultaneously. When making recordings on Tape/VCR 1 and 2 simultaneously, you may listen directly to the source, or you may monitor tape deck 2. DO NOT monitor tape deck 1 during this procedure.

If you wish to copy a tape, place it in deck 1, and press the Tape/VCR1 Copy button on your receiver. You may then record the tape using tape deck 2.

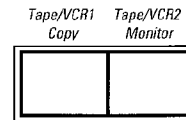

NOTE 1: To turn off the Tape/VCR 1 selection, press either A/V, Aux, Tuner or CD. To turn off the Tape/VCR 2, press Tape/VCR2 Monitor button again.

NOTE 2: To use a 3-head tape deck that allows monitoring of the actual recording while it is in process, you must connect it to TAPE/VCR 2 jacks. Pressing Tape/VCR1 Copy button will switch off the source.

Description of Dolby Pro Logic

The Dolby Pro Logic in this system is similar to professional Dolby Stereo decoders used in movie theaters. The Dolby Pro Logic system employs four-channels: the left and right main channels, the center channel (to characterize dialogue), and the rear surround-sound channel (to characterize sound effects, background and other ambient information).

Dolby Surround is encoded on the sound track of commercially available video cassettes and video discs as well. When you play a source encoded with Dolby Surround on your home theater system with the Dolby Pro Logic mode on, the AVR15 decodes the signal and steers the surround-sound effects. Dolby Pro Logic mode is also most effective on many stereo sources not encoded with Dolby Surround.

OPERATING INSTRUCTIONS

Using the Dolby Pro Logic Modes

When the AVR15 is in one of the Dolby Pro Logic modes and the Pro Logic Mode button is pressed, the display indicates the current mode setting for 10 seconds and then changes back to indicating the input source. This mode can only be changed within those 10 seconds while the current setting is displayed.

The AVR15 is normally in the Stereo ("DIRECT") mode until one of the Dolby Pro Logic modes are selected. If the Pro Logic Mode button is pressed while in the Stereo ("DIRECT") mode, the mode is changed to Pro Logic "NORMAL". This mode directs center channel audio signals to the CENTER speaker terminals and the rear channel audio signals to the REAR speaker terminals. This is the mode to use when both center and rear speakers are connected. Pressing the Pro Logic Mode button while "NORMAL" is displayed changes the mode from Normal to Phantom, and the display then indicates "PHANTM". This mode directs the center channel audio signals to the FRONT LEFT and RIGHT speaker terminals and the rear channel audio signals to the REAR speaker terminals. Use this mode when rear speakers are connected but center speaker(s) are NOT connected.

Pressing the Pro Logic Mode button while "PHANTM" is displayed changes the mode from Phantom to 3-Stereo, and "3-ST" is displayed. This mode directs the center channel audio signals to the CENTER speaker terminals. However, it also directs the rear channel audio signals to the FRONT LEFT and RIGHT speaker terminals. Use this mode when center speaker(s) are connected but rear speakers are NOT connected.

Pressing the Pro Logic Mode button while "3-ST" is displayed changes the mode from 3-Stereo to Direct, and "DIRECT" is displayed. Use this mode when neither center nor rear speakers are connected, or when listening in stereo rather than a surround mode is desired.

Pro Logic Mode	Display Indication	Speakers Connected		
		Left+Right	Center	Rear
Direct	DIRECT	Yes	No	No
Normal	NORMAL	Yes	Yes	Yes
Phantom	PHANTM	Yes	No	Yes
3-Stereo	3-ST	Yes	Yes	No

Balancing the Speaker System

The following steps should be set with reference to your listening position.

1. Press the Test Tone button on the Remote Control.
2. Turn up the Volume by using the Remote Control. You will hear a test tone (pink noise) that will continuously switch from speaker to speaker in a clockwise direction.
3. Adjust the Balance control for equal sound level from the left and right front speakers at your normal listening position.
4. Pull out on the Rear/Center Level control and adjust the center level so that the sound from the center speaker is the same level at your normal listening position, as the sound from the left and right front speakers. The "Center" level cannot be adjusted if Phantom mode is being used.

Level
Rear/Center (Pull)



5. Then push the Rear/Center Level control and adjust the rear speaker level to be equal to the level of the front speakers.

6. Turn off the test tone by pressing the Test Tone button again.

NOTE: Once the setup is complete use the AVR15's Volume control to adjust listening volume. The Volume control adjusts the rear, center and front speakers simultaneously. The rear and center level controls should be used for relative level balance adjustments only.

TROUBLESHOOTING

This unit is designed for trouble-free operation; most problems users encounter are due to operating errors. So if you have a problem, first check this list for a possible solution. If the problem persists, consult your authorized Harman Kardon service center.

If the problem is:

No lights illuminate when Power switch is pressed.

No sound is heard.

No sound is heard from the center speaker (only 1 center speaker is used).

Tuner sound has a large amount of interference.

OR

The "STEREO" display is not fully illuminated.

OR

Tuner sound distorts and/or volume level is too low.

Intermittent or continuous buzzing or hissing.

Stations cannot be preset.

Cannot monitor a recording using Tape 1.

Make sure that:

■ The unit is plugged into a live outlet.

■ Press the Speakers switches corresponding to the desired speakers.

■ Correct function button has been pressed.

■ Volume is turned up.

■ Speaker wires are connected properly.

■ Hook-up wires to source component are connected properly.

■ The Center Speaker 2 terminals are connected by a jumper wire.

■ The antenna is properly connected.

■ The antenna is properly located.

■ The antenna is set in the proper direction.

■ The antenna is adequate to receive the desired station.

■ The unit is away from fluorescent lights, TVs, motors and other electrical appliances.

■ After pressing Memory switch, the preset button is set while the "PRESET" light is still flashing.

■ This is not possible. Use Tape 2.

SPECIFICATIONS

Amplifier Section

Continuous Average Power (FTC)	Front (both channels driven @ 2ch stereo):	25 Watts × 2 (8 Ohms, 20Hz - 20kHz with 0.09% THD)
	Front (both channels driven @ 2ch stereo):	35 Watts × 2 (4 Ohms, 20Hz - 20kHz with 0.3% THD)
	Center (@ Dolby Pro Logic Normal mode):	25 Watts × 1 (8 Ohms, 20Hz - 20kHz with 0.09% THD)
	Rear (@ Dolby Pro Logic Normal mode):	10 Watts × 2 (4 Ohms, 1kHz with 0.3% THD)
Dynamic Power (IHF, 1kHz tone burst)	8 Ohms:	35 Watts
	4 Ohms:	50 Watts
	2 Ohms:	60 Watts
High Instantaneous Current Capability (HCC):		±25 Amps
Negative Feedback:		26dB
Power Bandwidth @ half-rated output, 8Ω:		<10Hz - 100kHz
Frequency Response @ 1W (+0/-3dB):		0.5Hz - 150kHz
Slew Rate*:		80V/μsec
Rise Time:		1.8μsec
Transient Intermodulation Distortion (TIM):		Unmeasurable
Damping Factor:		45
Signal-to-Noise Ratio (reference rated power output, A-Wtd.):		98dB
Input Sensitivity/Impedance:		135mV/22kΩ
Tone Control Range, Bass @ 50Hz/Treble @ 10kHz:		±10dB/±10dB
Loudness Contour @ -40dB, 50Hz/10kHz:		+10dB/ -
Tuner Section: FM		
Usable Sensitivity Mono:		13.2dBf
50dB Quieting Sensitivity, stereo:		46dBf
Signal-to-Noise Ratio @ 65dBf, mono/stereo:		70dB/63dB
Capture Ratio:		1dB
Selectivity, Adjacent/Alternate Channel:		10dB/70dB
IF Rejection:		100dB
AM Rejection @ 45dBf:		55dB
Stereo Separation @ 1kHz, 65dBf:		45dB
THD @ 1kHz, 65dBf; mono/stereo:		0.15%/0.2%
Tuner Section: AM		
Sensitivity, Ext. Antenna:		25μV
Alternate Channel Selectivity:		45dB
Image Rejection:		40dB
IF Rejection:		60dB
Dimensions (Width × Height × Depth):		443 × 105 × 349mm
Weight:		8.4kg

* Measured without input anti-slewing and output isolation networks.
All features and specifications are subject to change without notice.

Declaration of Conformity



We, Harman Marketing Europe a/s
Kongevejen 194B
DK-3460 Birkerød
DENMARK

declare in own responsibility, that the
product described in this owners
manual is in compliance with technical
standards:

EN 55013/6.1990, EN 55020/6.1988,
EN 55022/4.1987

Accredited test laboratory:
MIKES PRODUCT SERVICE GmbH
Ohmstrasse 2-4
D-94342 Strasskirchen

Birkerød, DENMARK, 05.03.1994

Steen Michaelsen

harman marketing europe a/s

The appliance conforms with EEC directive
87/308/EEC regarding interference
suppression.