

harman/kardon

LINEAR PHASE STEREO FM/AM TUNER

TU610

owner's manual



Your investment in a component high fidelity system indicates you have a more than average interest in music. The fact that your investment includes a Harman Kardon TU610 Linear Phase Stereo FM/AM Tuner shows us your appreciation of uncompromised reproduction of the music you enjoy. Throughout the design and manufacture of this unit, we made every effort to assure it will meet all your expectations. To ensure continuing high performance, read this manual carefully before you connect and operate your TU610.

Contents

Features	3
General Instructions	3
Locations for Installations	3
Components and Their Functions	4-6
Front Panel	4,5
Rear Panel	6
Connections	7,8
AM Antenna	8
FM Antenna	8
Operation Procedure	9
Listening to FM/AM broadcast	9
Listening to a distant FM broadcast	9
Maintenance	9

WARNING: TO PREVENT FIRE OR SHOCK HAZARD, DO NOT EXPOSE THIS APPLIANCE TO RAIN OR MOISTURE.

Features

- Simple, slim design laying stress on easy operation.
- Color-changing dial illumination and signal level indicators for easy tuning to the desired station.
- Special design for clear AM reception with excellent selectivity by reduction of beat interference from adjacent channels and improvement of interfrequency rejection ratio.
- Adoption of high quality ceramic filters in 3 stages for sonic improvement in FM reception with minimum distortion.
- Low noise, high gain, and high-impedance input in FM reception by adoption of cascade FET for radio frequency amplification.

General Instructions

Always use at 120V AC

This unit is designed for use at 120V AC. Do not connect the unit to an outlet supplying a higher voltage to prevent fire.

Handle the AC cord carefully

- Always hold the plug when disconnecting the AC cord from the outlet. Pulling at the cord may cause discontinuity.
- If the unit is not used for a prolonged period, disconnect the plug from the outlet.
- Do not place or drop a heavy material such as furniture on the cord. Otherwise, the cord may be damaged to cause fire or shock hazard.



- ★ Always disconnect the plug from the outlet before making connections with other components.

Do not open the cabinet

To prevent shock hazard or unexpected trouble, do not tamper with internal components for inspection or maintenance. Harman Kardon does not guarantee performance degradation resulting from any modification.

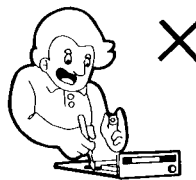

When water or a metal piece enters the unit

When water, a hair pin or wire accidentally enters the unit, immediately extract the AC plug from the outlet to prevent shock or trouble.

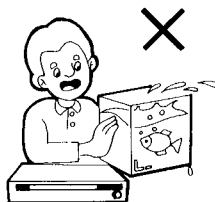

Carry the unit Carefully

Do not mistake the ferrite loopstick AM antenna for a handle. Its bracket cannot support the unit.

Locations for Installation

Install the TU610 on a firm level base.

Avoid the following locations;

- Place exposed to direct sunlight or near a heat source
- Place exposed to excessive moisture
- Cold place such as near a cooling air outlet
- Dusty place
- Place exposed to excessive vibration
- Poorly ventilated place

Do not place other components on top of the TU610.

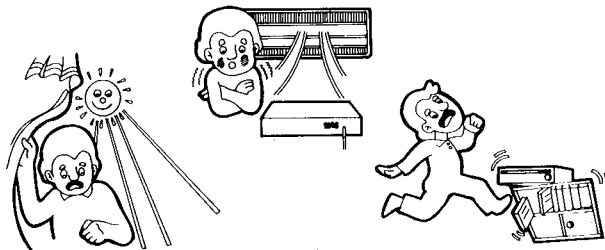

When piling with other components, carefully plan so as not to obstruct heat radiation from a pre-mainamplifier or mainamplifier. Use of a Harman Kardon audio rack is recommended.

Components and Their Functions

Front Panel

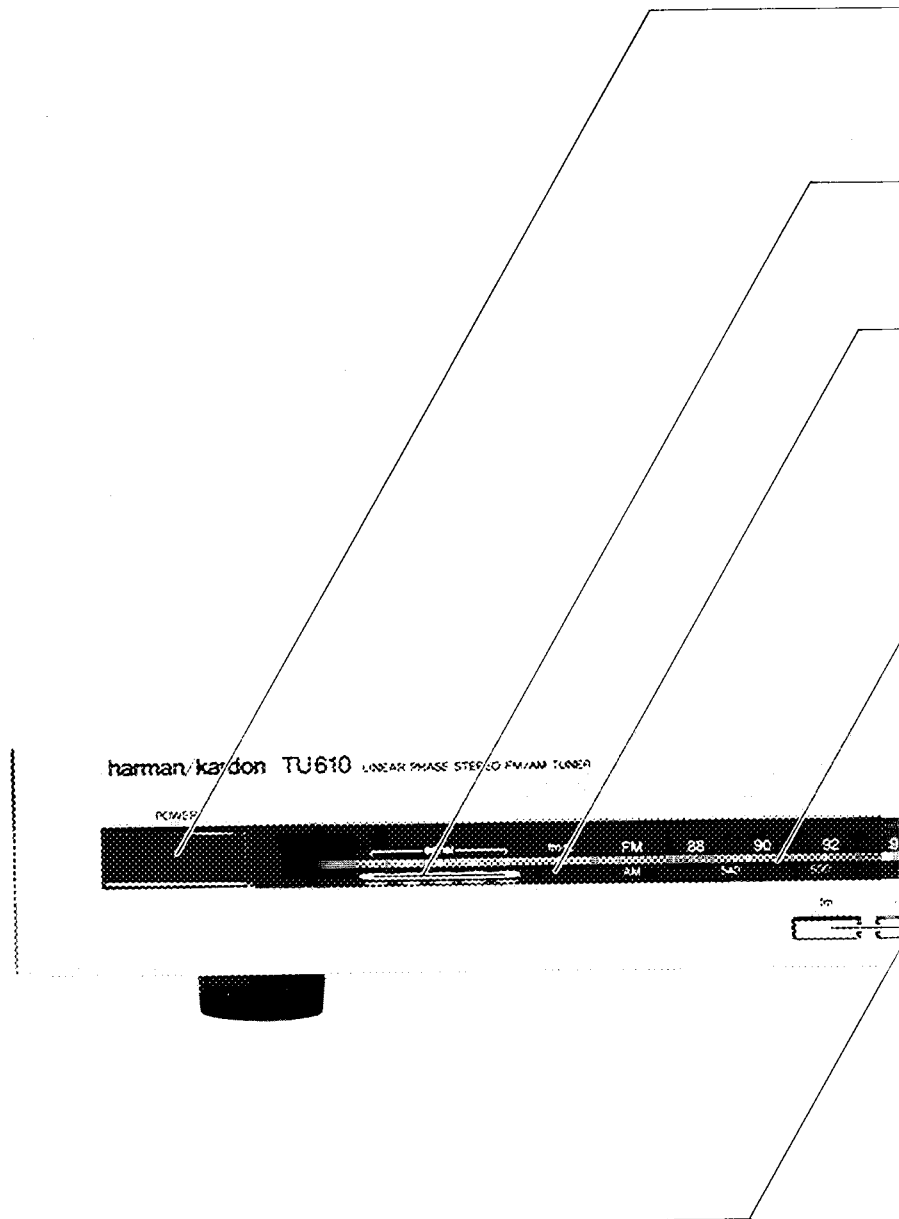

5 FUNCTION SELECTORS

- **FM SELECTOR (fm)**
For selection of FM mode.
Depress this selector to tune to an FM monaural broadcast or a weak FM stereo broadcast.
- **STEREO FM SELECTOR (stereo fm)**
For selection of FM stereo mode.
Depress this selector to tune to an FM stereo broadcast. The tuner will automatically enter monaural mode when it receives a monaural broadcast.
- **AM SELECTOR (am)**
For selection of AM mode.
Depress this selector to tune to an AM broadcast.

1 POWER SWITCH (POWER)

For power turning on and off.

When this switch is pressed after AC cord connection to an outlet, the FM/AM TUNING dial illuminates. Press this switch again to turn the power off.

2 SIGNAL STRENGTH INDICATOR (signal)

5 LEDs for indication of the receiving signal level.

As the signal gets stronger, more LEDs will illuminate.

3 STEREO FM INDICATOR (fm st.)

For indication of FM stereo broadcast reception.

4 FM/AM TUNING DIAL

For indication of tuning and detuning.

This dial illuminates when the power is supplied. As the TUNING knob is turned, it illuminates in green color if when a station is tuned, or in orange color detuned.

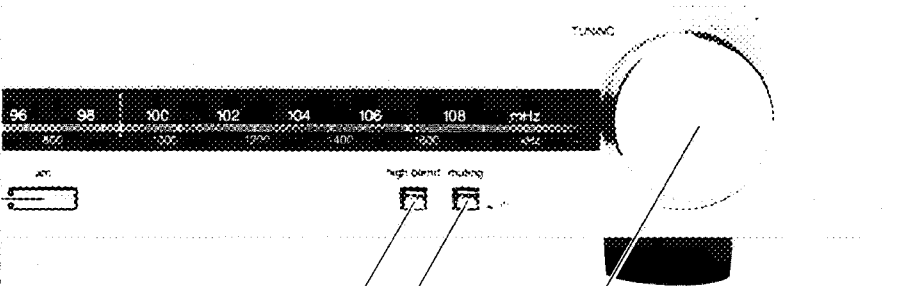

6 TUNING KNOB (TUNING)

For tuning to a station.

Turn this knob while observing the FM/AM TUNING dial. When a reasonably strong signal is sensed, the dial color changes from orange to green.

7 MUTING SWITCH (muting)

For reduction of interstation noise during scanning through the FM or AM band for a station.

To tune to a weak station, depress this switch to invalidate the muting function.

8 HIGH BLEND SWITCH (high blend)

For reduction of noise in high frequency range.

Depress this switch to receive a weak FM stereo broadcast with minimal noise.

Rear Panel

9 FM ANTENNA TERMINALS (FM 75Ω UNBAL)
Connect an FM coaxial antenna cable (75Ω) here.

10 FM ANTENNA TERMINALS (FM 300Ω BAL)
Connect an FM dipole antenna or an FM outdoor antenna cable here.

11 AM ANTENNA TERMINAL (AM)
Connect an AM outdoor antenna cable here to receive a weak broadcasting station.

12 AM FERRITE LOOPSTICK ANTENNA
For AM broadcast reception. Draw it out and move it to improve reception. Because of its high-sensitivity design, this built-in antenna is adequate for reception in most receiving condition except in a fringe reception area where signals are weak.

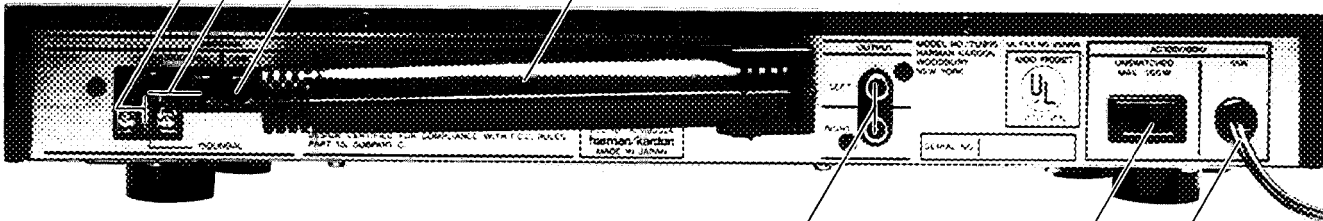

13 OUTPUT JACKS (OUTPUT)
Provide fixed stereo outputs. Connect signal cables to tuner (or aux) jacks of your preamplifier or pre-mainamplifier.

14 AC CONVENIENCE OUTLET (UNSWITCHED)
Connect the AC cord of another component here. This outlet always provides power regardless of whether the tuner is turned on or not.

15 AC CORD
Connect this cord to the AC convenience outlet of the pre-mainamplifier or a mains outlet.

Connections

- Always disconnect the AC cords connected to mains outlets before connections between components.
- Use the attached connection cords. Connect the plugs correctly to left and right channel jacks.
- Insert plugs fully. Imperfect insertion may cause noise or sound reproduction failure.

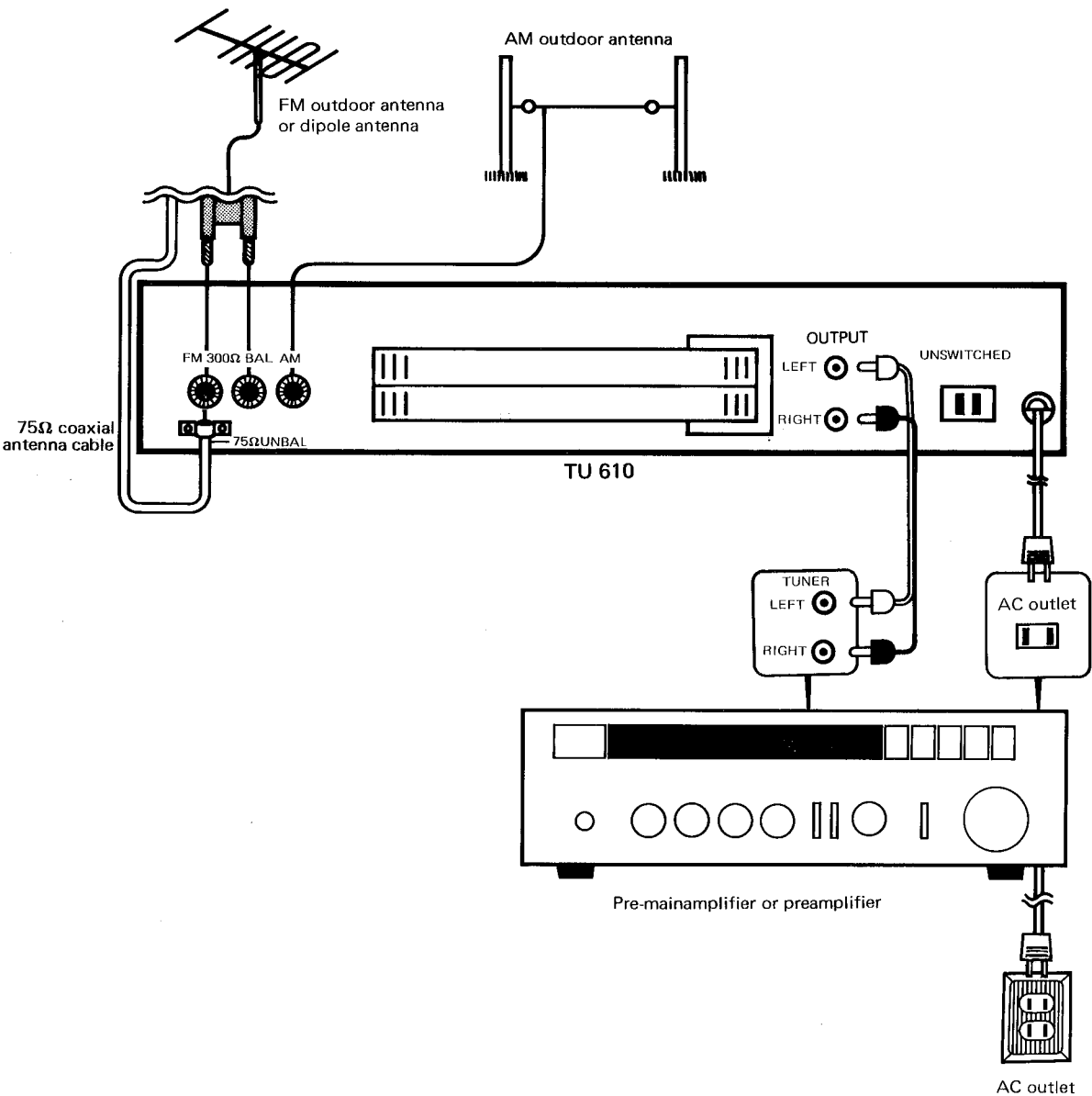

AM antenna

The TU610 is equipped with a high-sensitivity ferrite loopstick antenna so that it requires no external antenna for AM reception except in a fringe reception area where signals are weak

Ferrite loopstick antenna

Draw out the ferrite loopstick antenna and move it to the position for best reception.

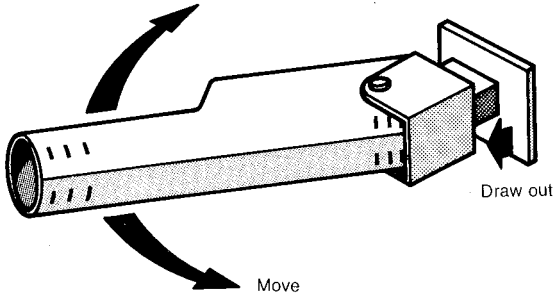

AM outdoor antenna

In a fringe reception area where the desired AM broadcast signal is too weak for good reception with the ferrite loopstick antenna, use an AM outdoor antenna.

FM antenna

Good FM antenna is a must for good reproduction of the excellent sound quality of FM broadcasting.

Near a station where the wave is strong

In an area near a station where the field intensity is sufficiently high or in a suburban area characterized with less noise, use the dipole antenna supplied with the unit.

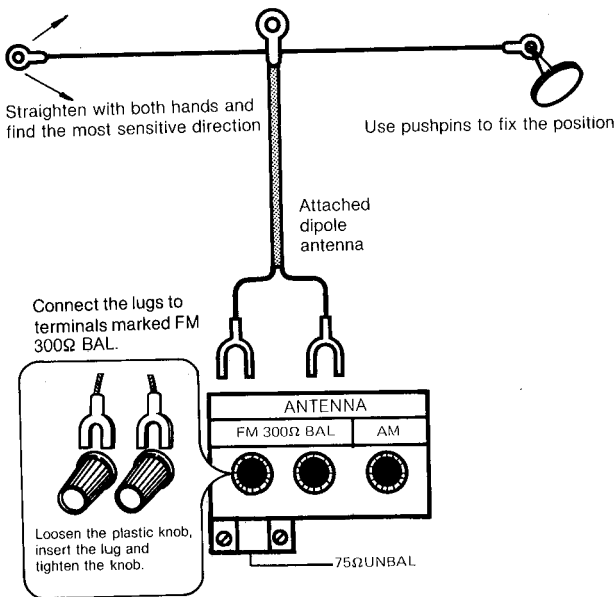

If high-quality reception is desired, use an FM outdoor antenna having a few elements.

Fringe reception area or behind a mountain or large building where the wave is weak

Use an FM outdoor antenna (for low field intensity) having 5 or more elements.

Because of the high directivity, sure reception of FM wave is possible even in a city area characterized with multipath caused by many large buildings.

If your outdoor antenna uses a 300Ω parallel feeder cable, connect the cable in the same way as explained for dipole antenna connection.

In an area characterized with heavy traffic or if the distance to the outdoor antenna is long, use a 75Ω coaxial antenna cable.

Connect the coaxial cable as follows:

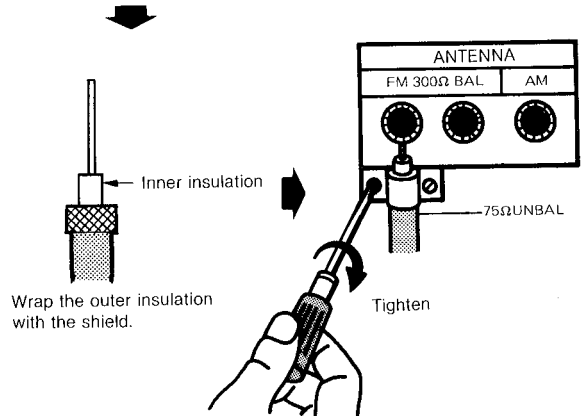
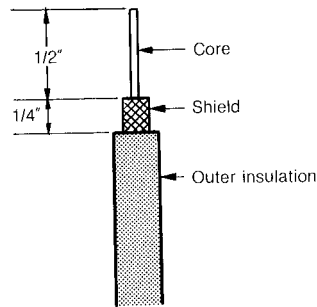

Recommended locations for FM outdoor antenna installation

1. A place enabling direct reception of FM outdoor without hindrance by a building.
2. A place off from a road to prevent sensing of automobile ignition noises.
3. A place at least 2m off from a metal roof, concrete building or TV antenna.
4. Normally the antenna shall be at least 4m above the ground and directed correctly to the transmitting antenna of the broadcasting station.

Operation Procedures

Listening to FM/AM broadcast

Accurate tuning to the desired broadcasting frequency is a must for good reception of an FM or AM broadcasting program.

1. Turn on the amplifier and select the tuner function according to the owner's manual of the amplifier.
2. Turn the volume control knob of the amplifier to the minimum level and press the POWER switch of this unit. The tuning dial illuminates in green if tuned to a station, or orange if detuned.
3. Press the STEREO FM selector for FM reception or AM selector for AM reception.



4. Turn the TUNING knob until the desired station is tuned. The FM/AM TUNING DIAL color changes from orange to green to inform correct tuning.

For fine tuning, watch the SIGNAL STRENGTH indicator.

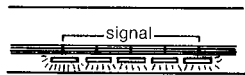

When a wave is sensed, the SIGNAL STRENGTH indicator illuminates. As the signal gets stronger, more LEDs will illuminate.



The FM STEREO indicator illuminates when an FM stereo broadcast is received.

5. Turn the volume control knob of the amplifier to a desired level.
6. Adjust the tone control knobs of the amplifier as desired.
7. When a weak FM stereo broadcast is received, depress the HIGH BLEND switch to reduce the noise. For stereo reception, at least 2 LEDs of the SIGNAL STRENGTH indicator must be illuminating.

Listening to a distant FM broadcast

In normal FM reception, weak FM signals are cut off with noise by the FM muting function. To listen to such an FM program, operate as follows:

1. Turn on the amplifier and select the tuner function according to the owner's manual of the amplifier.
2. Turn the volume control knob of the amplifier to the minimum level and press the POWER switch of this unit. The tuning dial illuminates in green color if tuned to a station, or orange if detuned.
3. Press the FM selector.
4. Depress the MUTING switch to invalidate the muting function. The noise specific to the FM is heard.
5. Turn the TUNING knob until the desired station is tuned.
6. Adjust the sound volume and tone as desired.

Maintenance

When this unit gets dirty, wipe with a dry soft cloth. If heavily contaminated, soak a soft cloth in soapy water and wipe the dirt off. Then wipe with a dry soft cloth.

Never use alcohol, thinner, benzine or other volatile agent because painting may be damaged.