

Modification Kit

for the

Heathkit®

ET/ETW-3400 AND 3400A MICROPROCESSOR TRAINERS

Model ETA-3400/EWA-3400

This Modification Kit will let you interface the ET-3400 and the ET-3400A Microprocessor Trainers with the ETA-3400A or EWA-3400A Microprocessor I/O Memory Accessory.

If you previously purchased a Microprocessor Trainer, Model **ET-3400**, proceed to Part I of the Instructions (below). However, if you more recently purchased the Model **ET-3400A** Trainer, proceed directly to Part II of these Instructions. Perform only the steps outlined in the section that applies to your Trainer.

SPECIAL NOTICE

Before you unpack your Modification Kit and begin to install it, please review the enclosed manual information and consider the following:

1. This Modification Kit is provided as a service to Heathkit customers to update their products. The modification instructions have been thoroughly evaluated and tested.
2. Be extremely careful when you perform the modification. An incorrect installation can cause operational difficulties.
3. For the first ninety (90) days after you receive it, Heath will replace, free of charge, any parts contained within this Modification Kit that are defective, either in materials or workmanship. No warranty is implied nor extended to any other parts or service associated with the modification. Replacement parts can be obtained from Heath's Parts Department (phone number (616)-982-3571) or a Heathkit Electronic Center.
4. This Modification Kit is authorized only for the product(s) designated in the enclosed Manual.
5. You must perform the entire modification before Heath can accept the product for service. If service is required, labor and parts charges will apply (except for parts supplied with the modification kit, which will be replaced no charge if defective).

If you find that the Modification Kit is not suitable for your purposes at this time, you may return it prepaid for credit or a refund by contacting Heath Company, Parts Department (phone (616)-982-3571). But, once the kit has been unpacked and/or assembly commenced, it is no longer resalable as a kit and a credit or refund request cannot be accommodated.

597-1954-02

PART I

IMPORTANT NOTICE

After you install this Modification in your Microprocessor Trainer, the clock frequency for the Microprocessor will be changed. This change in clock frequency will improve the performance of the Trainer and allow you to use it successfully with the ETA-3400 I/O Memory Accessory. However, the change in microprocessor clock frequency will also modify some of the experiments in the EE-3401 Microprocessor course. These experiments were designed to be used with the standard trainer RC clock. We recommend that you complete these experiments prior to installing this Modification Kit.

PARTS LIST

KEY No.	HEATH Part No.	QTY.	DESCRIPTION	CIRCUIT Comp. No.
A1	6-102-12	1	1000 Ω (brown-black-red) resistor	R49
B4	21-51	1	20 pF ceramic capacitor	C23
C1	56-89	1	GD510 diode	
	344-59	15"	White wire	
	347-55	8"	8-wire flat cable	
H14	404-536	1	4 MHz crystal	Y1
E3	432-1062	1	40-pin dual connector	
	346-20	1"	Sleeving	
			Instruction sheet	

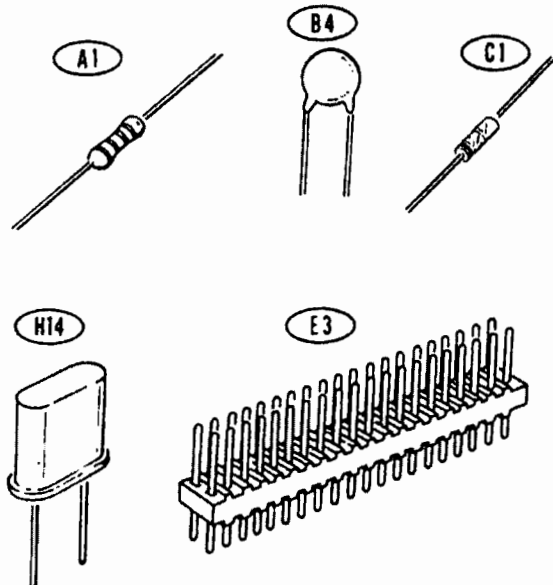

TRAINER MODIFICATIONS

The following steps will modify your Heath ET-3400 Microprocessor Trainer so it will operate with the ETA/EWA-3400 Memory I/O Accessory.

DISASSEMBLY

- () Make sure the Trainer line cord is unplugged.
- () Refer to Pictorial 1-1 and Detail 1-1A and remove integrated circuits IC9 and IC10. Temporarily set the integrated circuits aside.

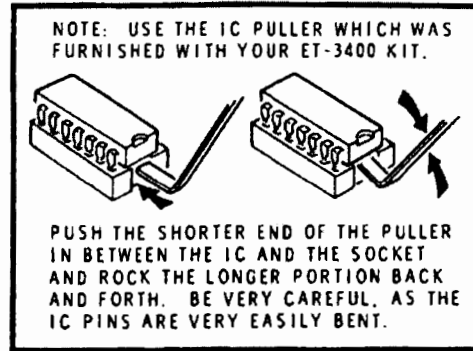

Detail 1-1A

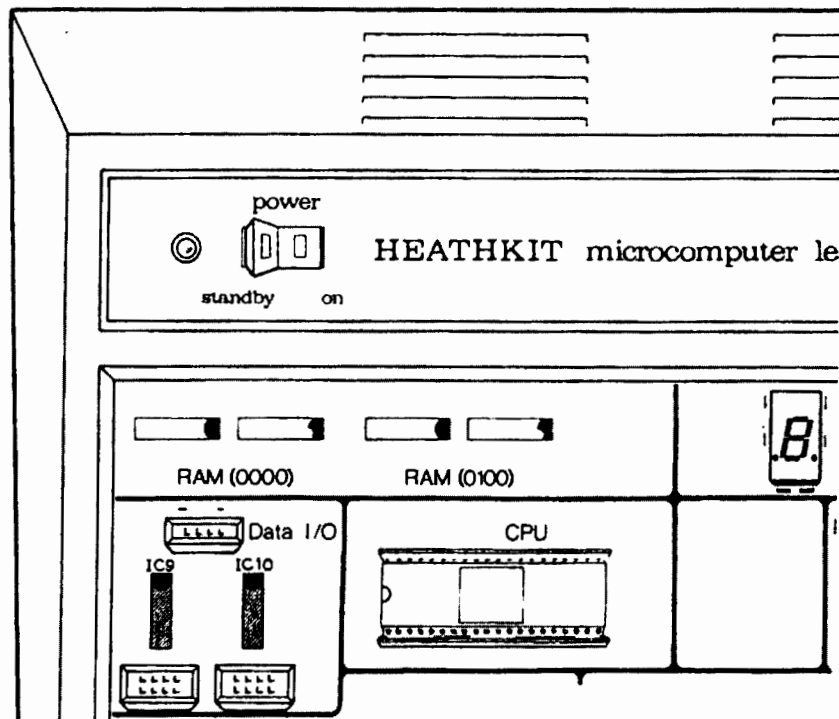

PICTORIAL 1-1

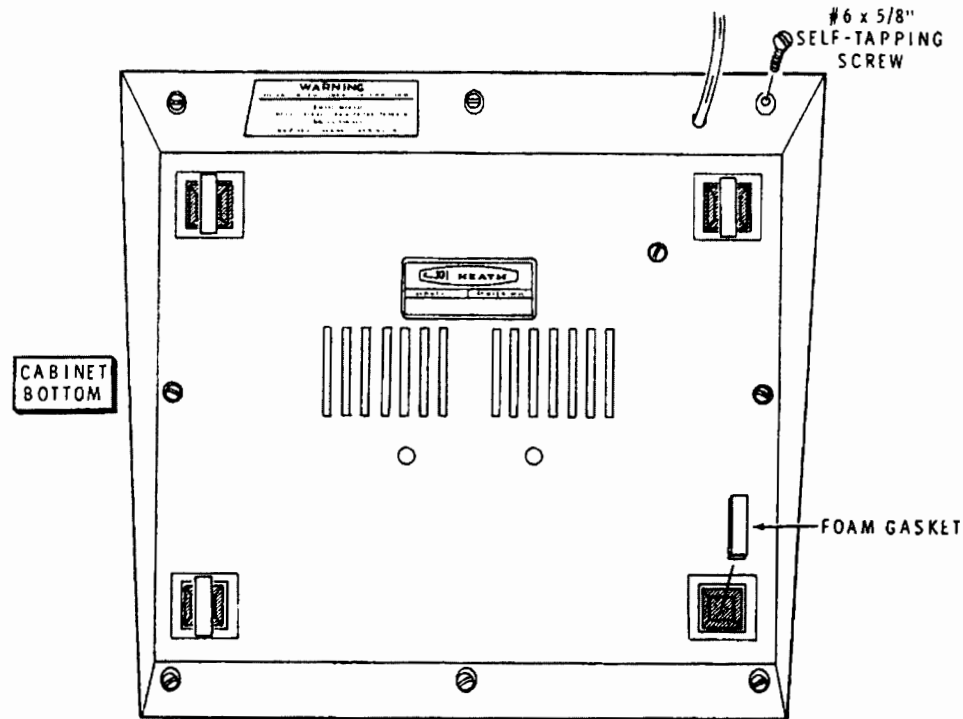

PICTORIAL 1-2

Refer to Pictorial 1-2 for the following steps.

- () Turn the Trainer cabinet upside down as shown in the Pictorial.
- () Remove and save the eight #6 × 5/8" self-tapping screws which secure the cabinet bottom to the cabinet top.
- () Cut four 1/2" lengths of foam gasket (#73-92).
- () Remove the protective paper backing from one side of each of the foam gaskets; then press the gaskets onto the plastic feet of the Trainer as shown. NOTE: Do not remove the protective paper backing from the exposed side of the foam gaskets until told to do so.



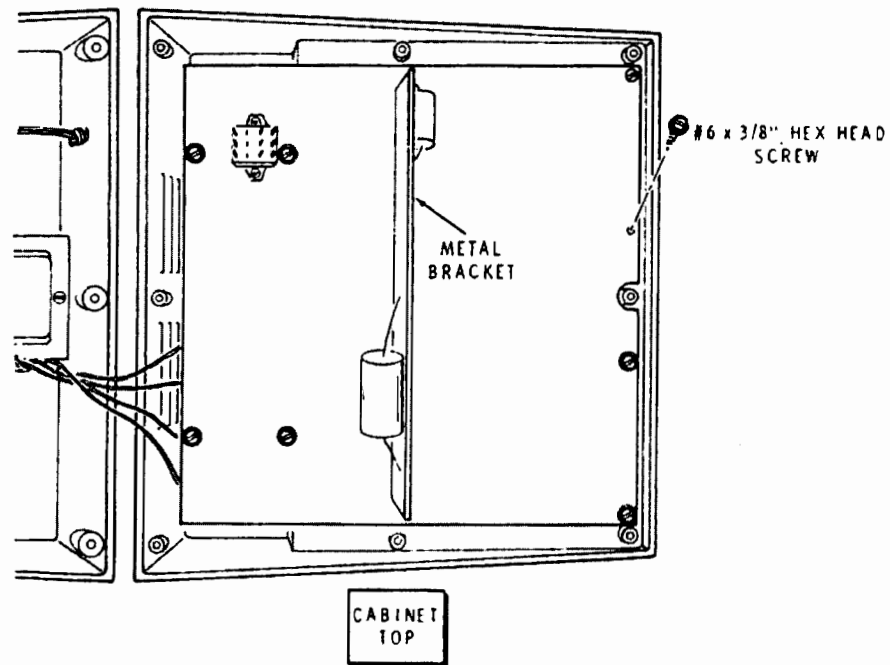

PICTORIAL 1-3

Refer to Pictorial 1-3 for the following steps.

() Lift the cabinet bottom from the cabinet top and position the cabinet halves as shown in the Pictorial.

() Remove and save the eight #6 × 3/8" hex head screws which secure the main circuit board to the cabinet top.

() Lift the main circuit board from the cabinet top and temporarily set the cabinet top aside.

CLOCK MODIFICATION

START

() Position the main circuit board as shown in the Pictorial.

NOTE: When you unsolder a component, use the following procedure:

1. Place the desoldering braid on the foil side of the main circuit board where the solder is to be removed.
2. Place the hot soldering iron on top of the desoldering braid for a few seconds. The solder will begin to flow up the braid, removing practically all the solder from the pad area and hole.
3. Remove the braid and soldering iron from the pad area at the same time.

CAUTION: Do not heat the connection for too long a period of time or the foil may be damaged.

4. Use diagonal cutters to cut off the solder end of the braid, and repeat the preceding steps as required to remove all the solder from the component lead and foil pad.

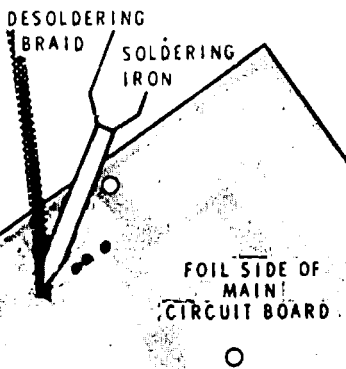

The steps performed in this Pictorial are in this area of the circuit board.

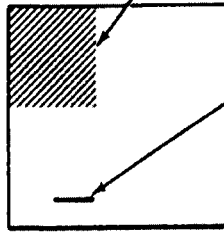

IDENTIFICATION DRAWING

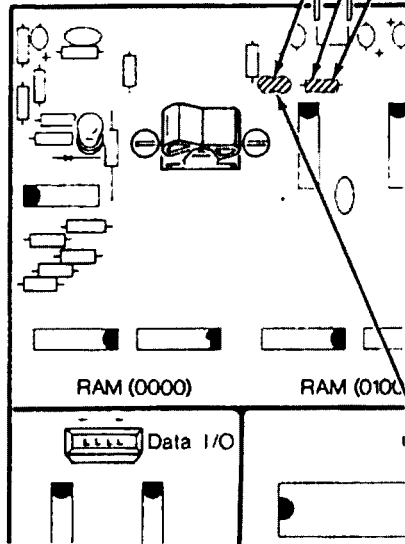

CONTINUE

- () C23: Unsolder the leads from the foil and remove the 100 pF capacitor.
- () R49: Unsolder the leads from the foil and remove the 1200 Ω (brown-red-red) resistor.
- () R49: Install the 1000 Ω (brown-black-red) resistor. Solder the leads to the foil and cut off the excess lead lengths.
- () Connect the leads of the 4 MHz crystal to the leads of the 20 pF ceramic capacitor as shown. Solder the connections; then cut off the excess crystal lead lengths. Do not cut the capacitor leads yet.

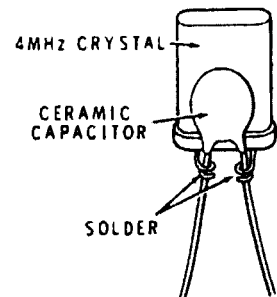

- () C23/Y1: Install the crystal-capacitor combination. Be sure the crystal and capacitor are positioned as shown; then solder the capacitor leads to the foil and cut off the excess lead lengths.

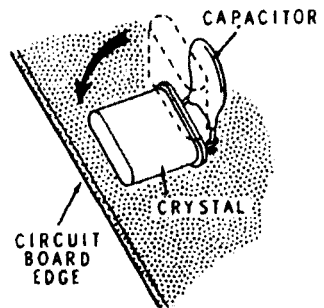

FINISH

PICTORIAL 1-4

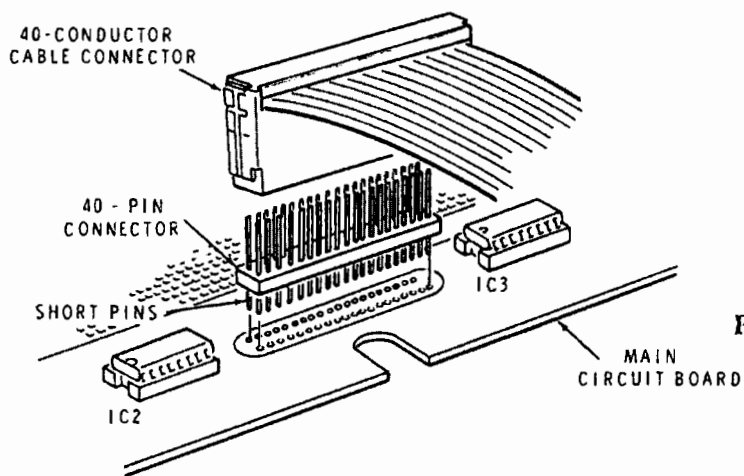

WIRING MODIFICATION

Refer to Pictorial 1-5 for the following steps. NOTE: If you have already installed a 40-pin connector for system expansion, disregard the next four steps.

- () 1. Position the main circuit board as shown in the Pictorial.
- () 2. Install the 40-pin connector in one 40-conductor cable connector as shown.
- () 3. Guide the short pins of the 40-pin connector through the holes on the main circuit board; then solder the pins to the foil.
- () 4. Disconnect the 40-pin conductor cable from the 40-pin connector and set it aside.

Refer to Pictorial 1-6 (fold-in) and the inset drawings for the following steps. NOTE: If you have already installed and wired a 40-pin connector for system expansion, be sure the connections are equivalent to those described in the following steps. Then proceed to "Reassembly."

- () Cut two 7" white solid wires. Then remove 1/8" of insulation from the ends.
- () Position the main circuit board as shown in the Pictorial.
- () Remove the hardware from both ends of the large metal bracket on the foil side of the circuit board. This will permit you to move the bracket back to make the modification easier.

CAUTION: Be sure you do not damage the foil conductors on the circuit board in the following step.

- () Use a knife to carefully remove the solder resist coating from the \overline{RE} and $\phi 2$ foil pads.
- () Solder one end of a 7" white wire to the $\phi 2$ foil pad.
- () Position this 7" white wire as shown in the Pictorial. Then solder the free end of the wire to pins 15 and 26 of the 40-pin connector. Be sure you do not form a solder bridge to adjacent connector pins.
- () Solder one end of the other 7" white wire to the \overline{RE} foil pad.
- () Position this 7" white wire as shown in the Pictorial and slide the heat shrink sleeving over the free end of the wire. Then form a small hook in the end of the wire.
- () Cut both leads of a GD510 diode (#56-89) to 3/8". Then form a small hook in the lead at the unbanded end of the diode.
- () Place the hooked diode lead into the hook on the 7" white wire and solder them together.
- () After the connection cools, slide the sleeving over it. Then heat the sleeving with a match until it shrinks around the connection.
- () Solder the lead at the banded end of the diode to pins 6 and 35 as shown in the inset drawing on the Pictorial.

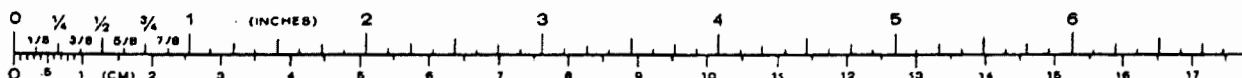

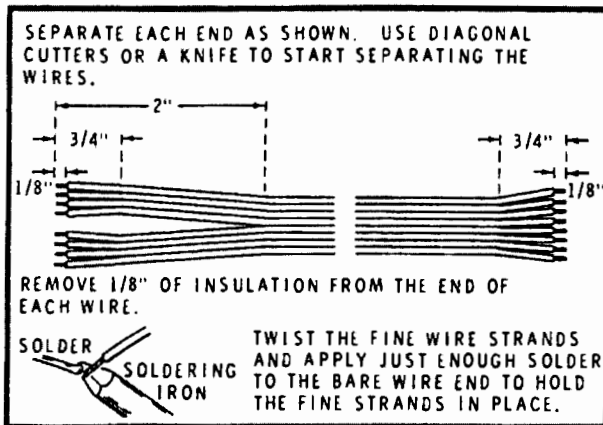

Detail 1-6A

- () Refer to Detail 1-6A and prepare the ends of the 8-wire flat cable.
- () Position the 8-wire flat cable as shown in the Pictorial; then solder the wire ends to the foil pads as shown in the inset drawings.
- () Position the diode that you connected to pins 6 and 35 (three steps back) toward the 8-wire flat cable. This will keep it from interfering with the cabinet top that you will install later.
- () Carefully inspect the circuit board for unsoldered connections, poor solder connections, solder bridges between foils, and protruding leads which could touch each other.

REASSEMBLY

Refer back to Pictorial 1-3 for the following steps.

- () Remount the bracket to the circuit board.
- () Turn the cabinet top upside down and position it near the cabinet bottom as shown in the Pictorial. Lower the main circuit board down onto the inverted cabinet top; be sure that LED1, next to the Power switch, fits straight down into the LED grommet as shown in Detail 1-3A.
- () Secure the main circuit board to the cabinet top with eight #6 × 3/8" hex head screws.

Refer back to Pictorial 1-2 for the following steps.

- () Turn the cabinet top and main circuit board assembly right side up and fit the assembly into the cabinet bottom.

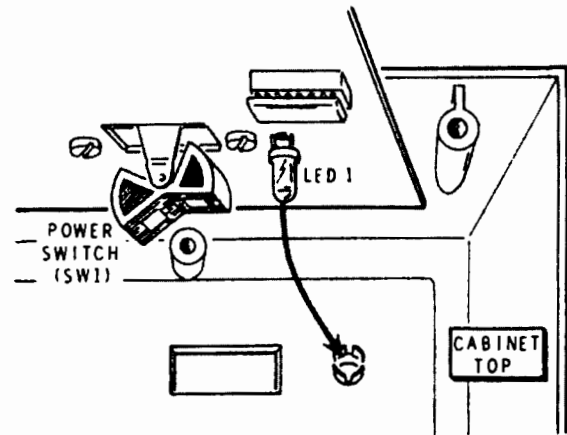

Detail 1-3A

- () Turn both cabinet halves bottom-side-up as shown in the Pictorial. Then secure the bottom to the top with eight #6 × 5/8" self-tapping screws.

Refer to Pictorial 1-7 (fold-in Page 1) and Detail 1-7B for the following two steps.

- () Reinstall either 74LS243 integrated circuit (#443-839) at IC9.
- () Reinstall the remaining 74LS243 integrated circuit (#443-839) at IC10.
- () Refer to the "Operational Tests" section of the separate ET-3400 Trainer Manual and verify that your unit is still operating properly. If you encounter any difficulty during the "Operational Tests;" be sure to troubleshoot the clock and wiring modifications first.

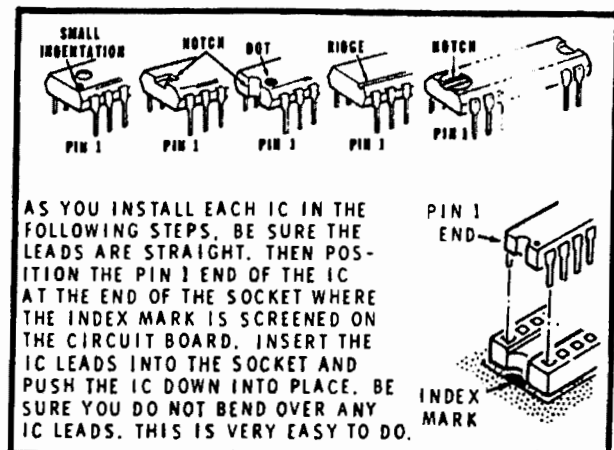

Detail 1-1B

NOTE: The following steps describe the removal of integrated circuits IC14 and IC15 (and IC16 and IC17, if used), as required for operation with your Memory I/O Accessory.

- () Make sure the ET-3400 Trainer line cord is unplugged.

NOTE: The integrated circuits (IC's) that you will remove are MOS devices that can be damaged by static electricity. Therefore, once you remove them from their sockets, do not lay them down until they have been properly stored.

Refer to Detail 1-7A and remove the IC from its socket. Then hold the IC in your hand.

If you have a piece of conductive foam (from previous MOS IC's) you can press the IC into this foam for storage. If you do not have a piece of conductive foam, install the IC in the large connector block at the bottom front of the Trainer.

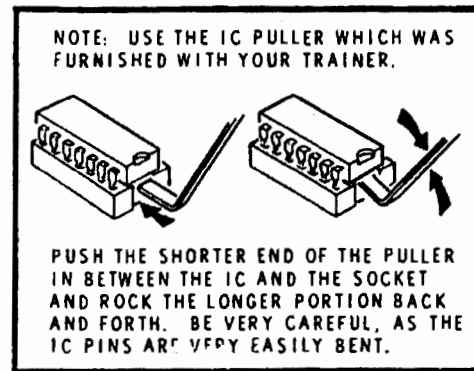

Detail 1-7A

- () Remove and set aside integrated circuits IC14 and IC15.
- () If used, remove and set aside integrated circuits IC16 and IC17.
- () Cut out the "Partial Schematic" from the fold-in. Then tape it over the corresponding part of the large schematic for your ET-3400 Trainer.

This completes the "Microprocessor Trainer Modifications."

PART II

PARTS LIST

NOTE: Remove the following (two) parts from those you received with this Modification Kit. The remaining parts will not be used.

<u>KEY</u> <u>No.</u>	<u>HEATH</u> <u>Part No.</u>	<u>QTY.</u>	<u>DESCRIPTION</u>	<u>CIRCUIT</u> <u>Comp. No.</u>
347-55		8"	8-wire flat cable	
432-1062		1	40-pin dual connector	

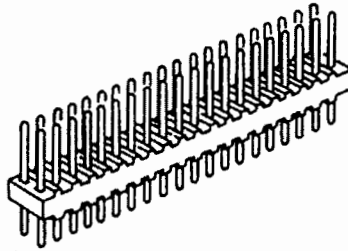

WARNING

This equipment is marketed pursuant to a waiver of FCC Rules Part 15 Subpart J. Operation of this computer in a residential area may cause objectionable interference to radio and TV reception, because it may emit more radio frequency energy than the FCC Rules allow. If interference occurs, the user will be required to take all steps necessary to correct the interference.

Constructing this product in strict accordance with the instructions in the Assembly Manual will minimize radio frequency interference signals emitted by the product.

If this equipment does cause interference to radio or television reception, which you can determine by turning the equipment off and on, try to correct the interference by one or more of the following measures:

- Move the computing device away from the receiver being interfered with.
- Relocate the computing device with respect to the receiver.
- Reorient the receiving antenna.
- Plug the computing device into a different AC outlet so that the computing device and receiver are on different branch circuits.

- Disconnect and remove any I/O cables that are not being used. (**Unterminated** I/O cables are a potential source of high RF emission levels.)
- Unplug and remove any serial I/O circuit board cards that are not being used. (Here again, **unterminated** cards can be a source of potential interference.)
- Be certain that the computing devices are plugged into grounded outlet receptacles. (Avoid using A/C cheater plugs. Lifting of the power cord ground may increase RF emission levels but also presents a lethal shock hazard to the user.)

If you need additional help, consult the dealer or ask for assistance from the manufacturer. Customer service information may be found on the inside back cover of this manual or on an insert sheet supplied with this equipment. You may also find the following booklet helpful: "How to Identify and Resolve Radio-TV Interference Problems". This booklet is available from the US Government Printing Office, Washington, D.C. 20402-Stock No. 004-000-00345-4.

TRAINER MODIFICATIONS

The following steps will modify your Heath ET-3400A Microprocessor Trainer so it will operate with the Memory I/O Accessory.

NOTE: In the following two steps, you will install adhesive foam gaskets to secure the Trainer to the top of the Memory I/O Accessory cabinet. Disregard these steps if you desire a temporary installation.

DISASSEMBLY

- () Make sure the Trainer line cord is unplugged.

- () Cut four 1/2" lengths of foam gasket (#73-92).

Refer to Pictorial 2-1 for the following steps.

- () Remove the protective paper backing from one side of each of the foam gaskets; then press the gaskets onto the plastic feet of the Trainer as shown. NOTE: Do not remove the protective paper backing from the exposed side of the foam gaskets until told to do so.

- () Turn the Trainer cabinet upside down as shown in the Pictorial.

- () Remove and save the eight #6 x 5/8" self-tapping screws which secure the cabinet bottom to the cabinet top.

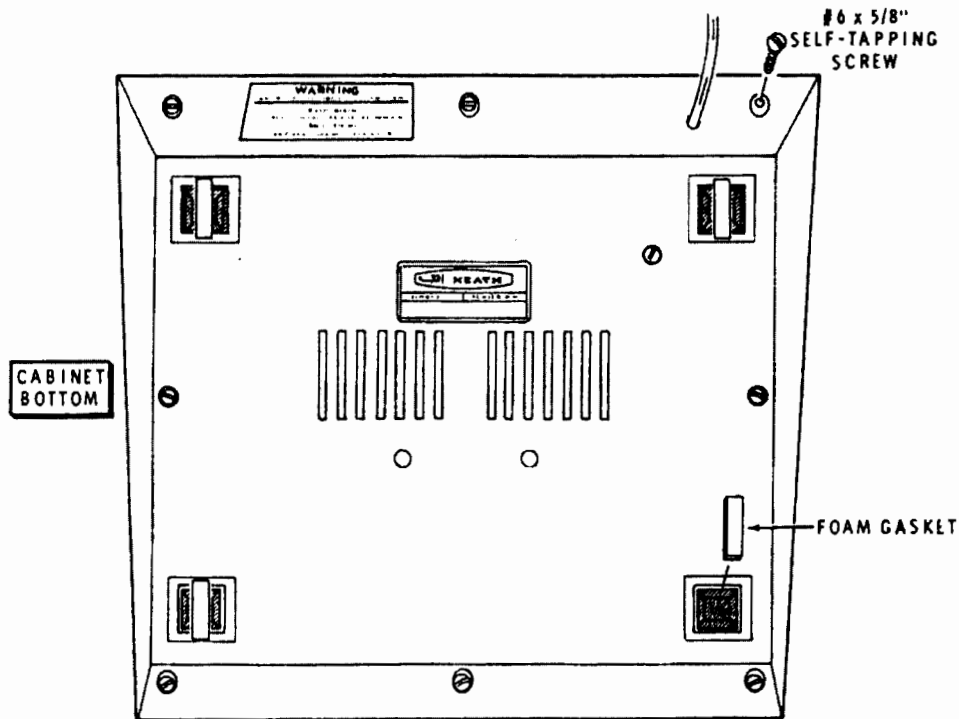

PICTORIAL 2-1

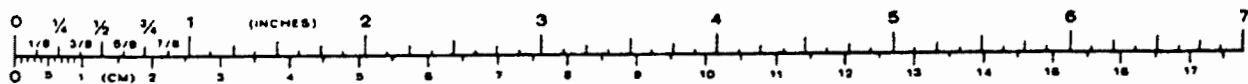

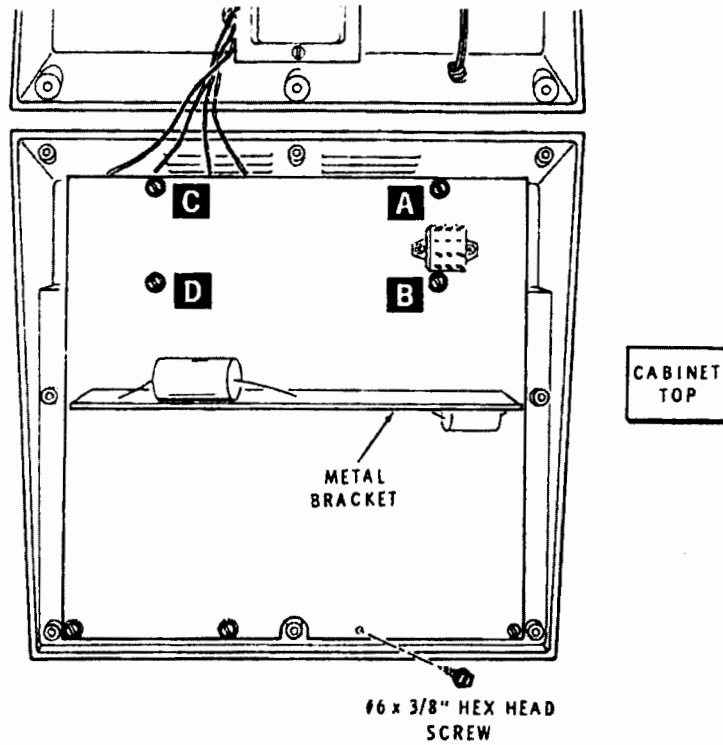

PICTORIAL 2-2

Refer to Pictorial 2-2 for the following steps.

- () Lift the cabinet bottom from the cabinet top and position the cabinet halves as shown in the Pictorial.
- () Remove and save the eight #6 × 3/8" hex head screws which secure the main circuit board to the cabinet top.
- () Lift the main circuit board from the cabinet top and temporarily set the cabinet top aside.

WIRING MODIFICATION

Refer to Pictorial 2-3 for the following steps. NOTE: If you have already installed a 40-pin connector for system expansion, proceed directly to Step 2 and, using diagonal cutters, cut the indicated pins from the 40-pin connector. Then skip Steps 3, 4, and 5.

- () 1. Position the main circuit board as shown in the Pictorial.

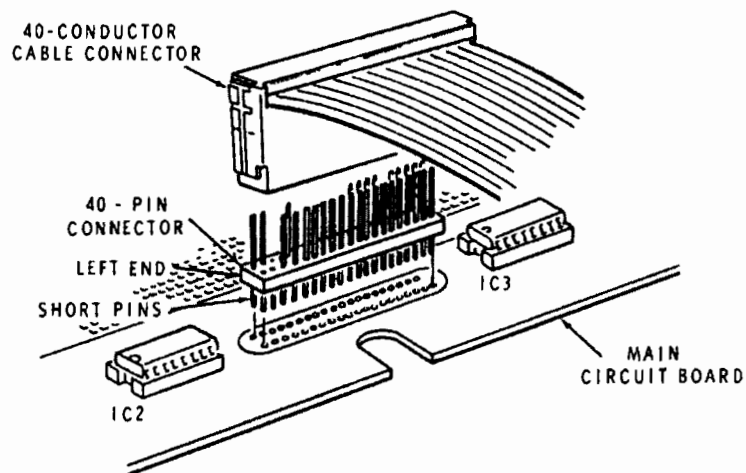

PICTORIAL 2-3

- () 2. Refer to Detail 2-3A and prepare the 40-pin connector as follows:
- A. From the front row of 20 pins, counting from the left, pull pins 1 and 2 from the connector.
 - B. From the rear row of 20 pins, counting from the left, pull pins 3, 4, 6, 7, 8, 9, 10, and 15.
- () 3. Install the 40-pin connector in one 40-conductor cable connector as shown.
- () 4. Guide the short pins of the 40-pin connector through the holes on the main circuit board; then solder the pins to the foil.
- () 5. Disconnect the 40-pin conductor cable from the 40-pin connector and set it aside.

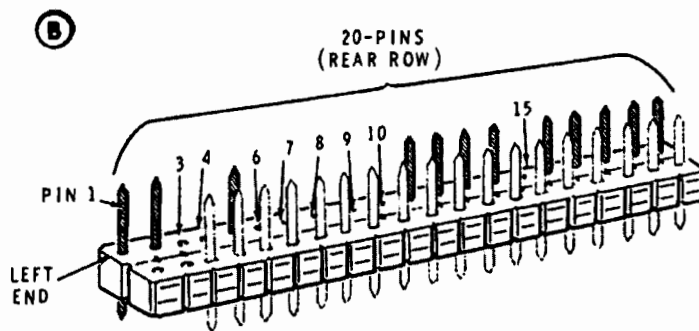
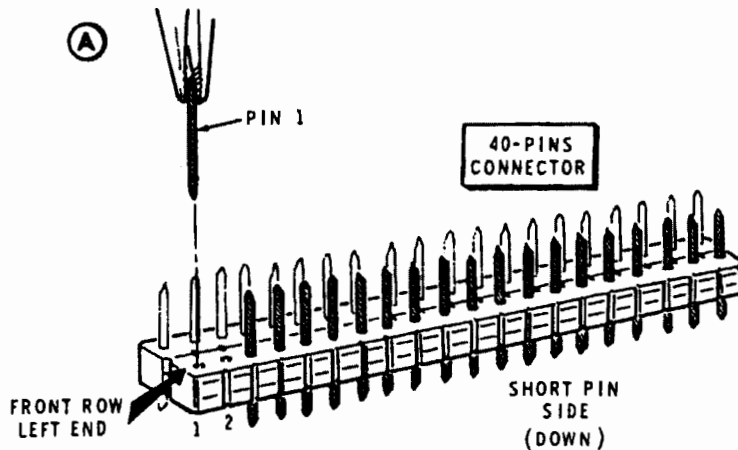

Detail 2-3A

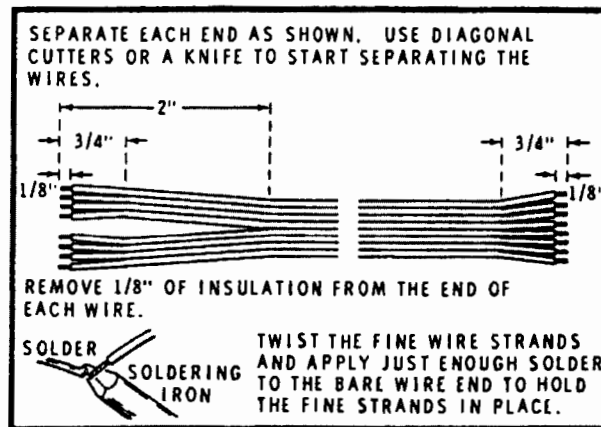

Detail 2-4A

Refer to Pictorial 2-4 (fold-in Page 2) and the inset drawings for the following steps.

- () Position the main circuit board as shown in the Pictorial.

CAUTION: Be sure you do not damage the small foil conductors on the circuit board in the following step.

- () Use a knife, a sharp tool, or the heat from your soldering iron and remove all the solder resist (colored coating) from the lower edge of the circuit board as shown in Pictorial 2-4.
- () Apply a thin coat of solder along the entire edge of the board from which you removed the solder resist coating.
- () Refer to Detail 2-4A and prepare the ends of the 8-wire flat cable as shown.

- () Position the 8-wire flat cable as shown in the Pictorial; then carefully solder the wire ends to the foil pads as shown in the inset drawings.
- () Locate the RF shield template on the fold-in Page 3. Cut this template from the page. Then place the template along one edge of the RF (foil) shield from your ETA/EWA-3400 Accessory Kit. Cut the edge of the foil **exactly** to the template pattern.
- () Carefully inspect the circuit board for unsoldered connections, poor solder connections, solder bridges between foils, and protruding leads which could touch each other.

REASSEMBLY

Refer back to Pictorial 2-2 for the following steps.

- () Turn the cabinet top upside down and position it near the cabinet bottom as shown in the Pictorial. Lower the main circuit board down onto the inverted cabinet top; be sure that LED1, next to the Power switch, fits straight down into the LED grommet as shown in Detail 2-2A.
- () Loosely secure the main circuit board to the cabinet top with four #6 × 3/8" hex head screws at A, B, C, and D.

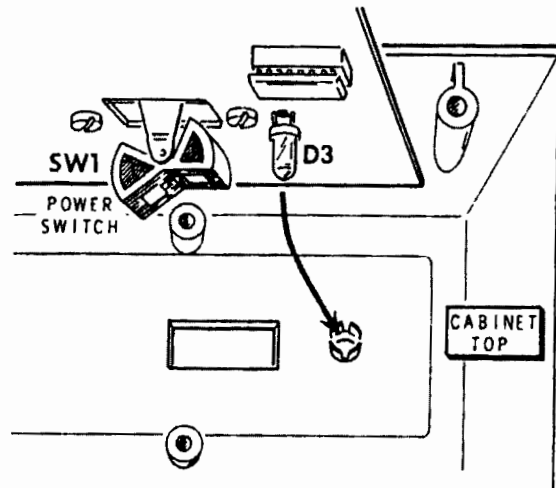

Detail 2-2A

Heathkit®

Refer to Pictorial 2-5 for the following steps.

- () Position the cut-out edge of the RF (foil) shield onto the ground edge from which you removed the solder resist.
- () With a pencil tip, push a hole through the shield at holes E and H. **NOTE: Be sure the edge of the shield does not touch any of the inner area foil pads.**
- () Lightly secure the RF shield at E and H with two #6 × 3/8" screws you previously removed.
- () Carefully cut a hole in the foil at mounting boss J. Be sure to leave the foil around the boss.
- () Push additional holes through the shield at F and G. Secure the shield at F and G with two #6 × 3/8" hex head screws.
- () Use the tip of your soldering iron to heat the edge of the RF (foil) shield where it makes contact with the ground edge of the circuit board. Use a little additional solder to help keep the iron tip tinned. Avoid getting any solder onto the adjacent component foil pads.
- () Carefully inspect along the inner edge of the foil for solder bridges between the small inner foil pads, and to make sure the foil is not touching any area beyond the ground-edge of the circuit board.

NOTE: The RF shield will extend out the front of your Microprocessor Trainer and you will connect the shield in a later step. Handle the Trainer carefully during the reassembly steps to avoid damaging this RF shield.

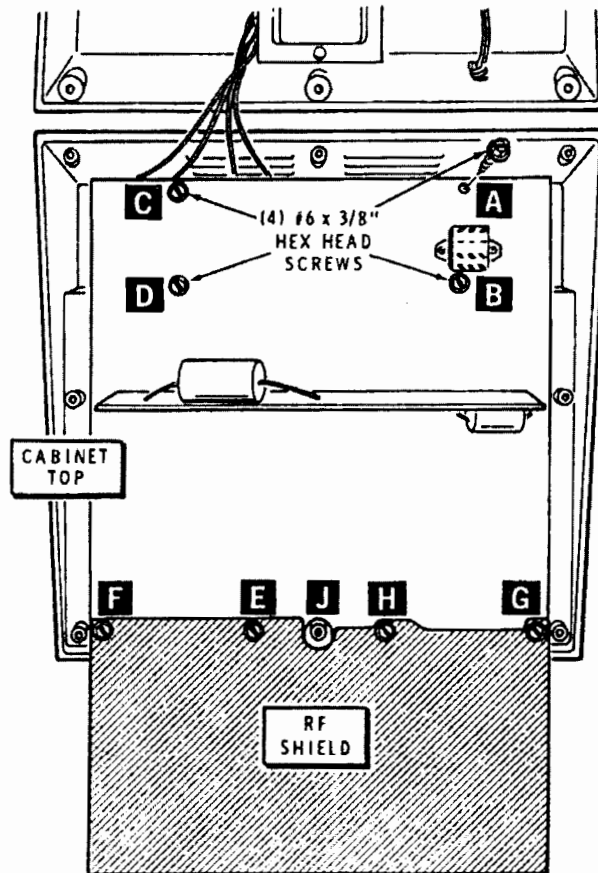

PICTORIAL 2-5

Refer back to Pictorial 2-1 for the following steps.

- () Turn the cabinet top and main circuit board assembly right side up and fit the assembly into the cabinet bottom.
- () Turn both cabinet halves bottom-side-up as shown in the Pictorial. Then secure the bottom to the top with eight #6 × 5/8" self-tapping screws.
- () Refer to the "Operational Tests" section of the separate ET-3400A Trainer Manual and verify that your unit is still operating properly. If you encounter any difficulty during the "Operational Tests:" be sure to troubleshoot the clock and wiring modifications first.

Refer to Pictorial 2-6 for the following steps.

NOTE: The following steps describe the removal of integrated circuits U14 and U15, as required for operation with your Memory I/O Accessory.

- () Make sure the ET-3400A Trainer line cord is unplugged.

NOTE: The integrated circuits (IC's) that you will remove are MOS devices that can be damaged by static electricity. Therefore, once you remove them from their sockets, do not lay them down until they have been properly stored.

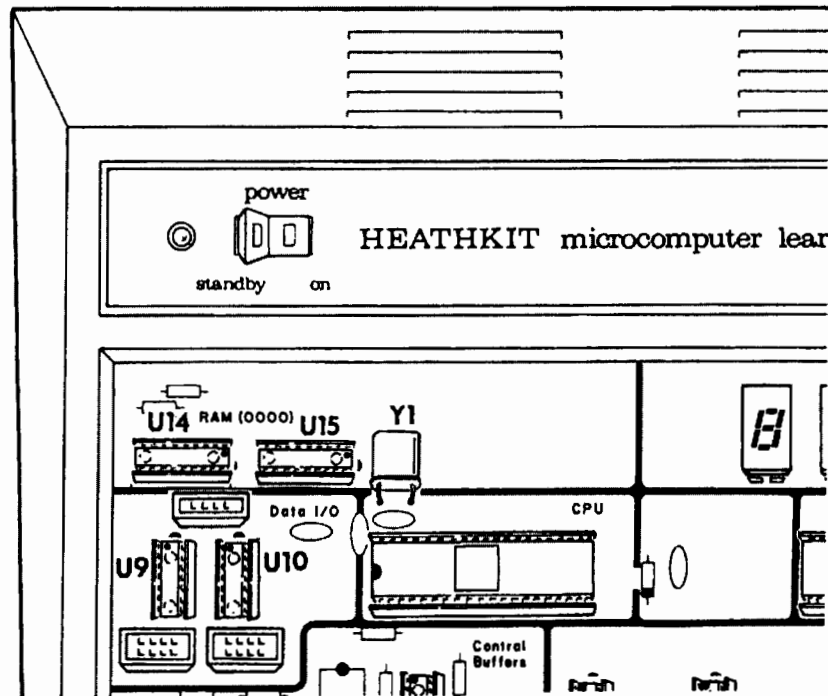

PICTORIAL 2-6

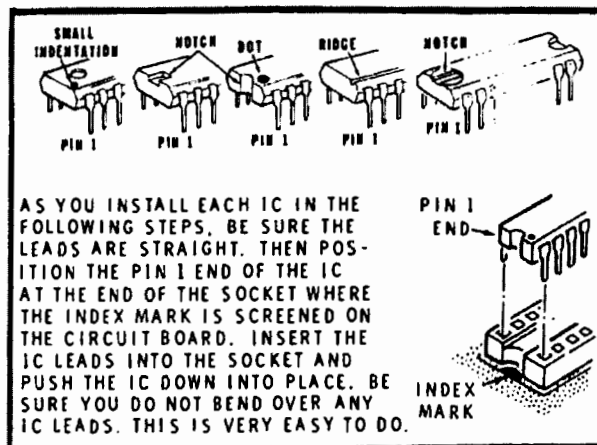
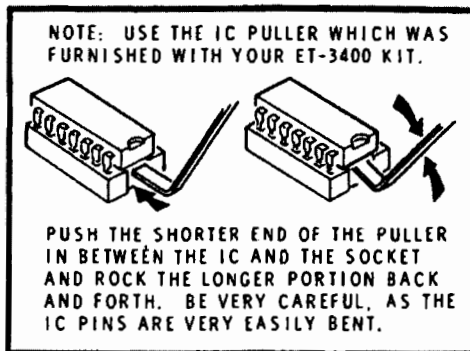

Detail 2-6B

Refer to Detail 2-6A and remove the IC from its socket. Then hold the IC in your hand.

If you have a piece of conductive foam (from previous MOS IC's) you can press the IC into its foam for storage. If you do not have a piece of conductive foam, install the IC in the large connector block at the bottom front of the Trainer.

- () Carefully remove and set aside integrated circuits U14 and U15.
- () Refer to Detail 2-6B and, taking care to observe the pin 1 end of each IC and making sure all the pins are straight, install the IC's into the ETA/EWA-3400 Memory Accessory at U115 and U116.

- () Using sandpaper, clean all paint from the top inner flange of the ETA/EWA Memory Accessory.
- () Secure the cover back onto the Memory Accessory on the **back** panel only with the screws you previously removed.
- () Place the Trainer onto the top of the Memory Accessory Cabinet. Roll the RF (foil) shield down and to the rear, and position the bare foil edge of the shield between the Accessory cabinet top and the front panel top flange. Secure the front panel of the Memory Accessory with the screws you previously removed.

This completes the "Microprocessor Trainer Modifications."

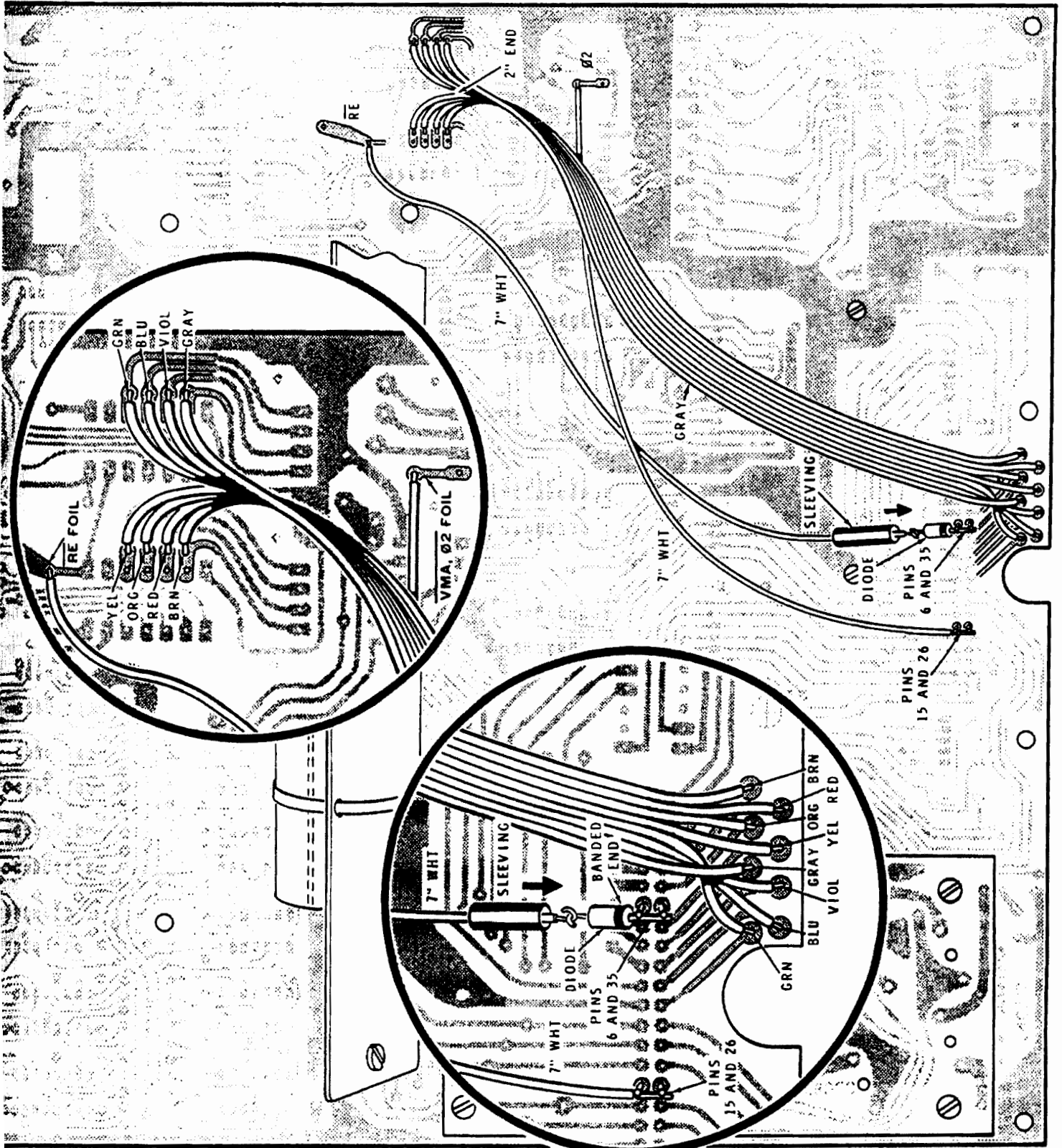

PICTORIAL 1-6

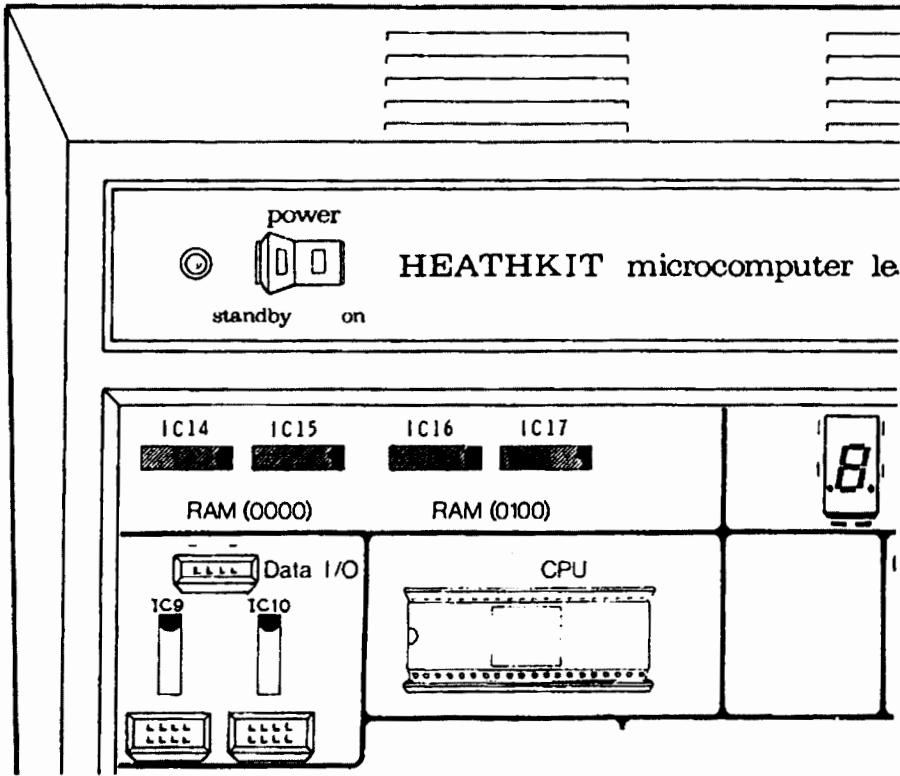

PICTORIAL 1-7