

IC OF THE
 THKIT®
 TIAL PROPORTIONAL
 EIVER
 GDA-57-2

- RESISTOR AND CAPACITOR NUMBERS ARE IN THE FOLLOWING GROUPS:
 0-99 PARTS MOUNTED ON THE RECEIVER CIRCUIT BOARD.
 100-199 PARTS MOUNTED ON THE DECODER CIRCUIT BOARD.
- ALL RESISTORS ARE 1/4 WATT UNLESS MARKED OTHERWISE. RESISTOR VALUES ARE IN OHMS (K = 1,000).
- ALL CAPACITOR VALUES ARE IN µF UNLESS MARKED OTHERWISE.
- THIS SYMBOL INDICATES A POSITIVE DC VOLTAGE MEASUREMENT WITH NO SIGNAL BEING RECEIVED.
- THIS SYMBOL INDICATES A POSITIVE DC VOLTAGE MEASUREMENT WITH SIGNAL BEING RECEIVED.
- ALL VOLTAGES ARE MEASURED WITH A HIGH IMPEDANCE VOLTMETER, FROM THE POINT INDICATED TO COMMON GROUND. VOLTAGES MAY VARY ±20%.
- REFER TO THE CIRCUIT BOARD X-RAY VIEWS FOR THE PHYSICAL LOCATION OF PARTS.

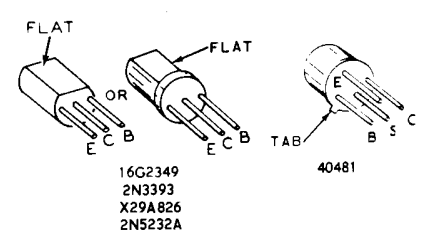

16G2349
 2N3393
 X29A826
 2N5232A

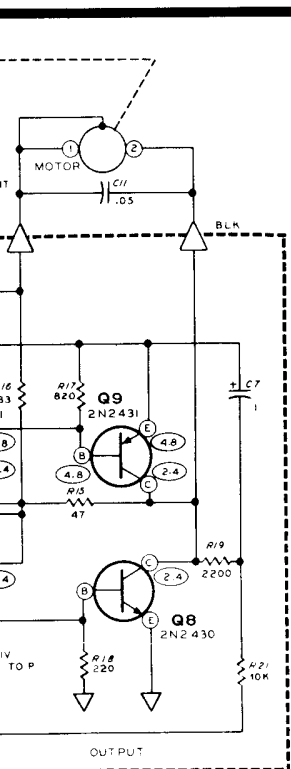
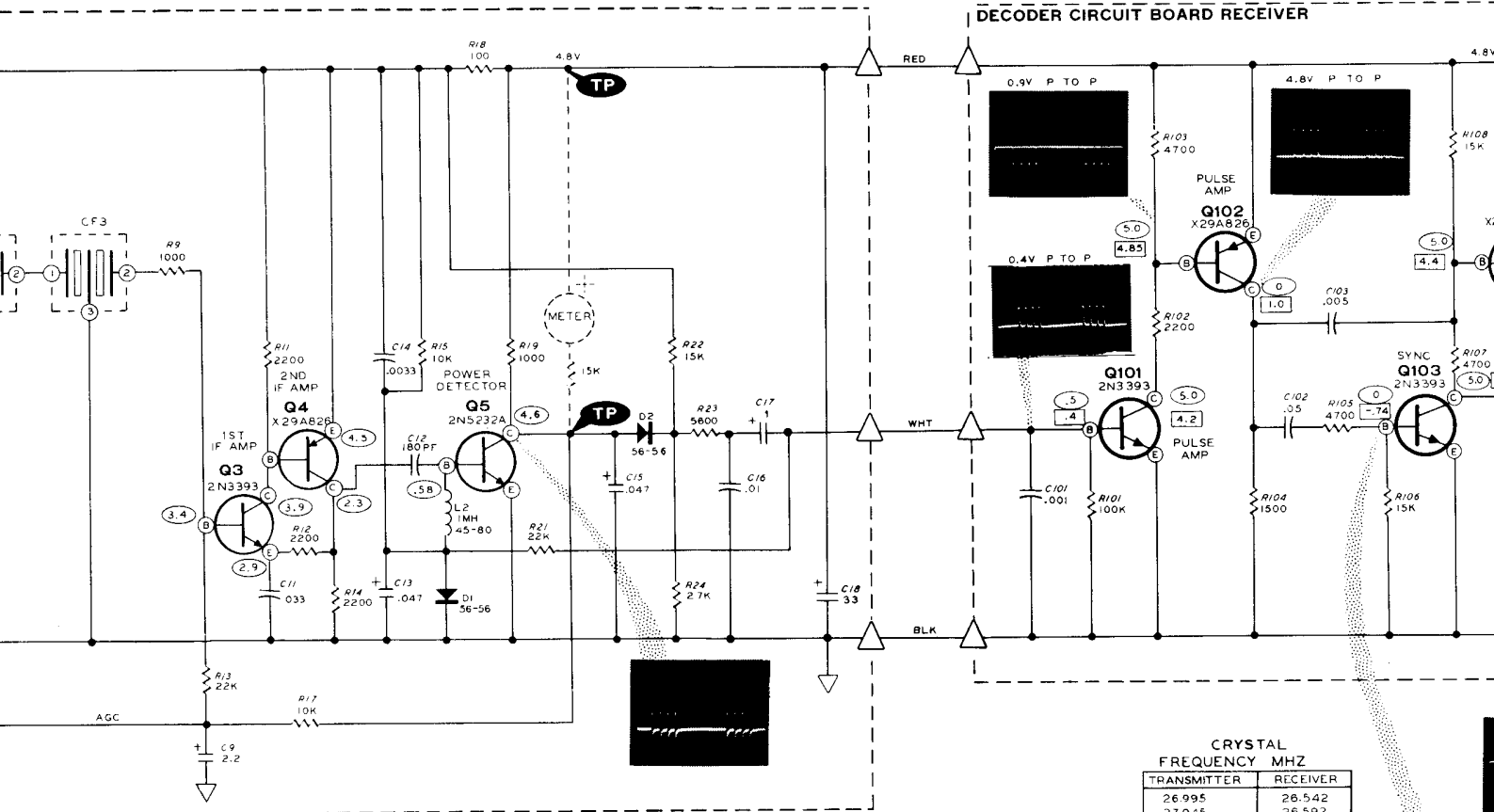

**SCHEMATIC OF THE
HEATHKIT[®]
DIGITAL PROPORTIONAL SERVO
MODEL GDA-19-4**

1. ALL RESISTORS ARE 1/4 WATT. RESISTOR VALUES ARE IN OHMS (K - 1,000, M - 1,000,000).
2. ALL CAPACITOR VALUES ARE IN μ F UNLESS MARKED OTHERWISE.
3. ○ THIS SYMBOL INDICATES A POSITIVE DC VOLTAGE MEASUREMENT WITH NO SIGNAL BEING RECEIVED.
4. ALL VOLTAGES ARE MEASURED WITH A HIGH IMPEDANCE VOLTMETER, FROM THE POINT INDICATED TO COMMON GROUND. VOLTAGES MAY VARY \pm 20%.
5. REFER TO THE SERVO PHOTOGRAPHS AND CIRCUIT BOARD X RAY VIEW FOR THE PHYSICAL LOCATION OF PARTS.
6. * THESE WAVEFORMS SHOW THE DRIVE SIGNALS FOR BOTH DIRECTIONS.

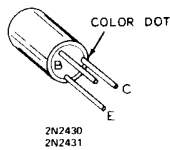
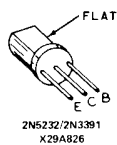

**SCHEMATIC OF
HEATHKIT[®]
3-CHANNEL DIGITAL
RECEIVER
MODEL GDA**

RECEIVER CIRCUIT BOARD

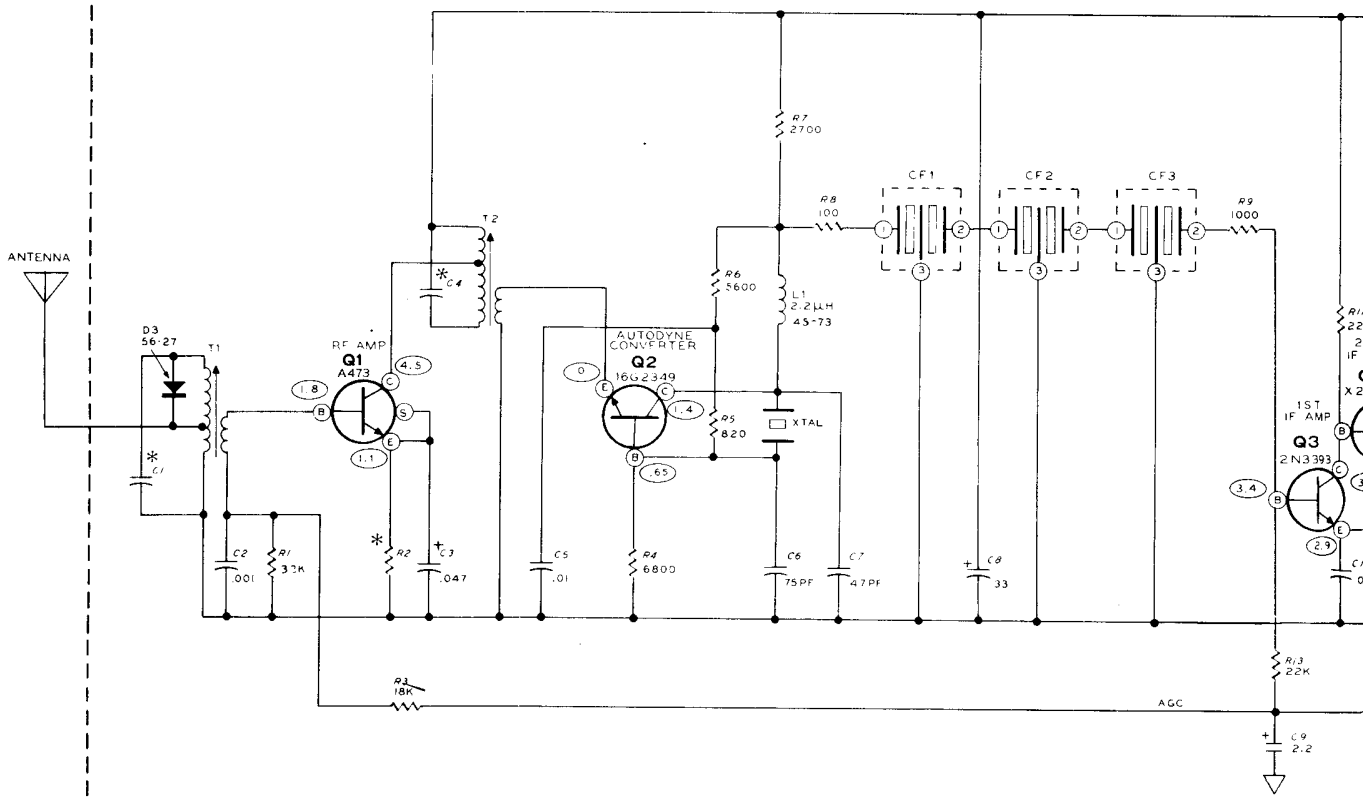

*	C1	C4	R2
27 MHZ	47PF	47PF	470
53-72 MHZ	27PF	27PF	2700

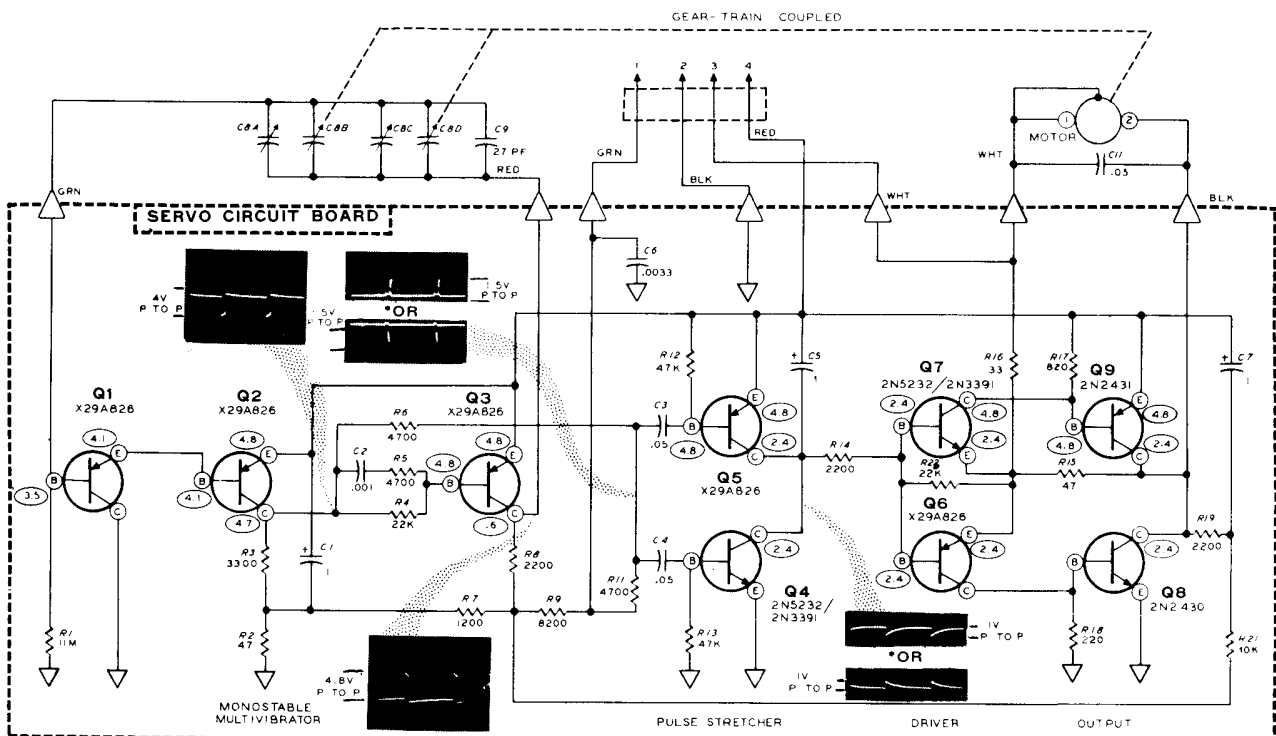

BATTERY CHARGING CIRCUIT

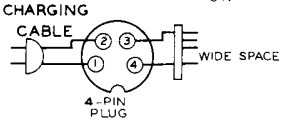
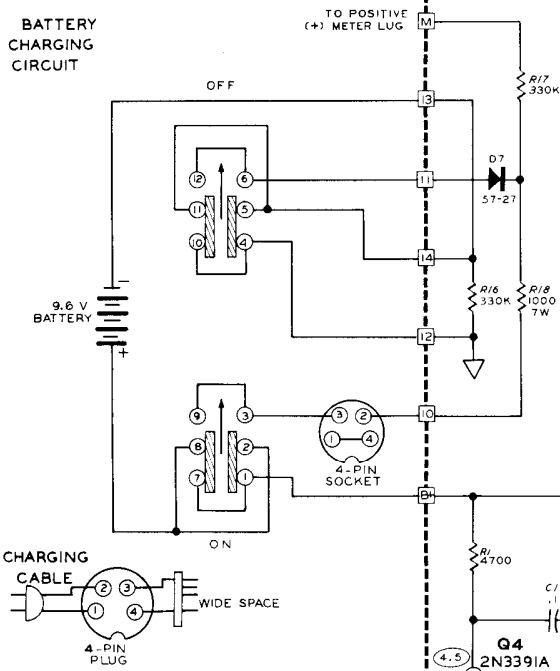

* SEE 53 MHZ BAND RF CIRCUIT BOARD.
 ** SEE 53 MHZ BAND RF CIRCUIT BOARD.

ENCODER CIRCUIT BOARD

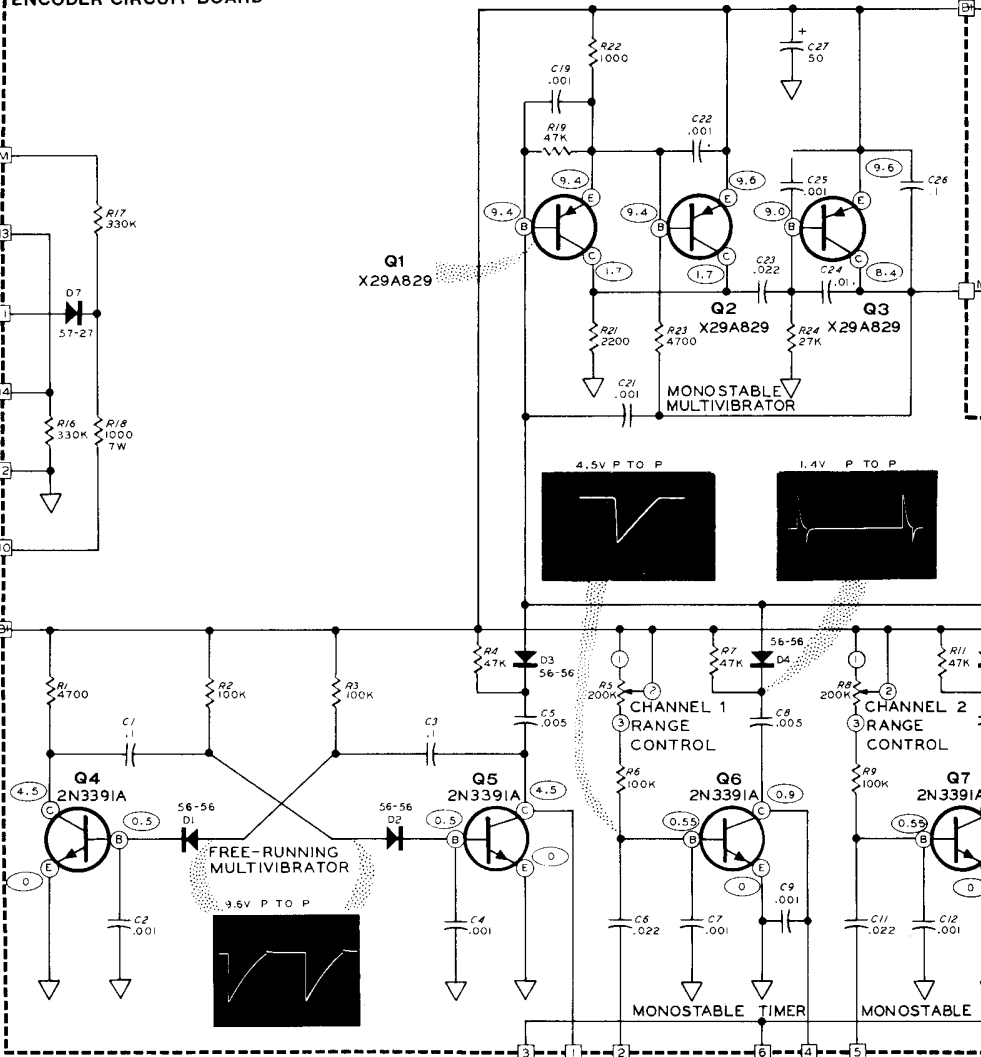

**SCHEMATIC OF THE
 HEATHKIT®
 3-CHANNEL DIGITAL PROPORTIONAL
 TRANSMITTER
 MODEL GDA-57-1**

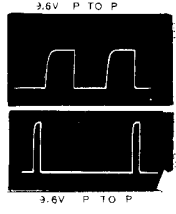

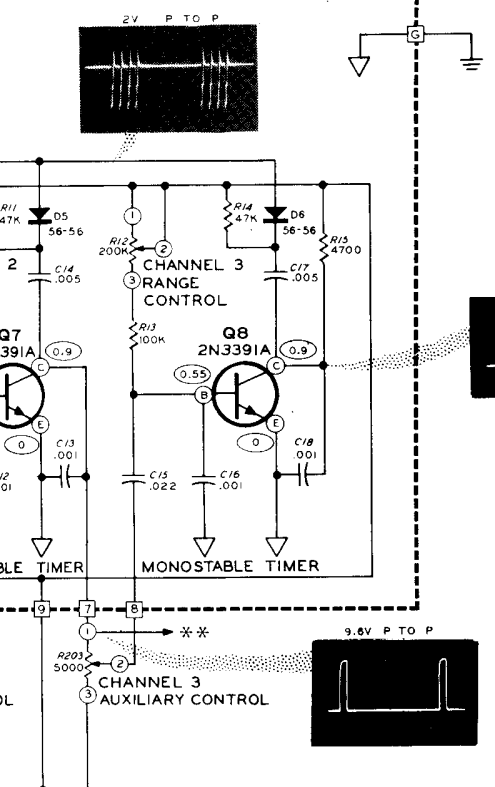
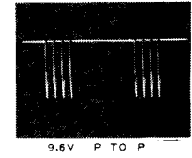
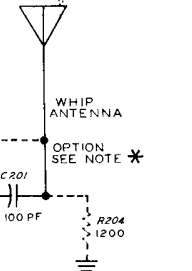
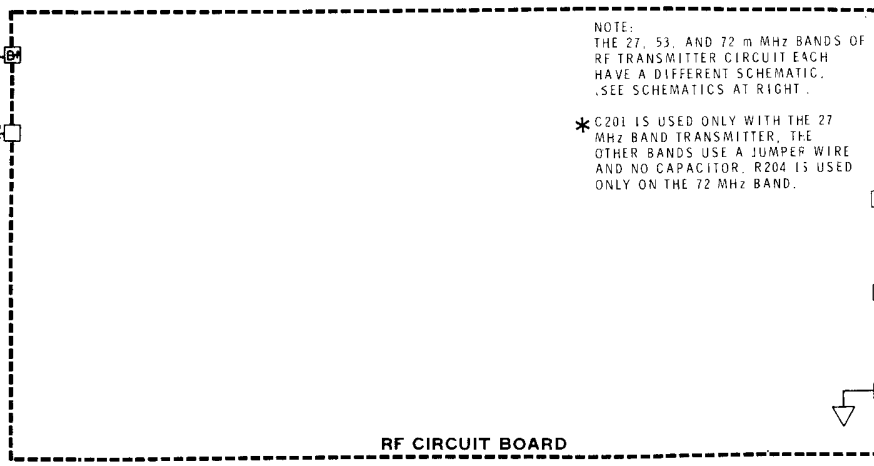
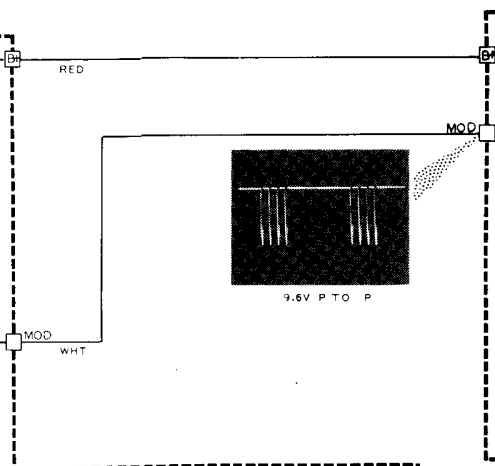

CRYSTAL FREQUENCY MHZ

	TRANSMITTER	RECEIVER
27 MHz BAND	26.995	26.542
	27.045	26.592
	27.095	26.642
	27.145	26.692
	27.195	26.742
53 MHz BAND	53.100	26.3235
	53.200	26.3735
	53.300	26.4235
	53.400	26.4735
	53.500	26.5235
72 MHz BAND	36.040	36.2665
	36.120	36.3465
	36.200	36.4265
	36.480	36.7065
	37.820	37.5935

- RESISTOR AND CAPACITOR NUMBERS ARE IN THE FOLLOWING GROUPS:
 0-99 PARTS MOUNTED ON THE ENCODER CIRCUIT BOARD.
 100-199 PARTS MOUNTED ON THE RF CIRCUIT BOARD.
 200-299 PARTS MOUNTED ON THE CHASSIS.
- ALL RESISTORS ARE 1/2 WATT UNLESS MARKED OTHERWISE. RESISTOR VALUES ARE IN OHMS (K = 1000).
- ALL CAPACITOR VALUES ARE IN μ F UNLESS MARKED OTHERWISE.
- THIS SYMBOL INDICATES A POSITIVE DC VOLTAGE MEASUREMENT, TAKEN WITH A HIGH IMPEDANCE VOLT METER, FROM THE POINT INDICATED TO CHASSIS GROUND. VOLTAGES MAY VARY $\pm 20\%$.
- REFER TO THE CHASSIS PHOTOGRAPHS AND CIRCUIT BOARD X-RAY VIEWS FOR THE PHYSICAL LOCATION OF PARTS.

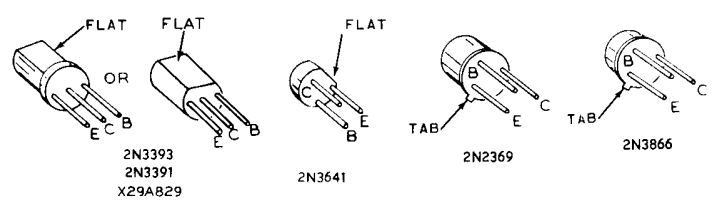

27 MHz BAND - RF CIRCUIT BOARD

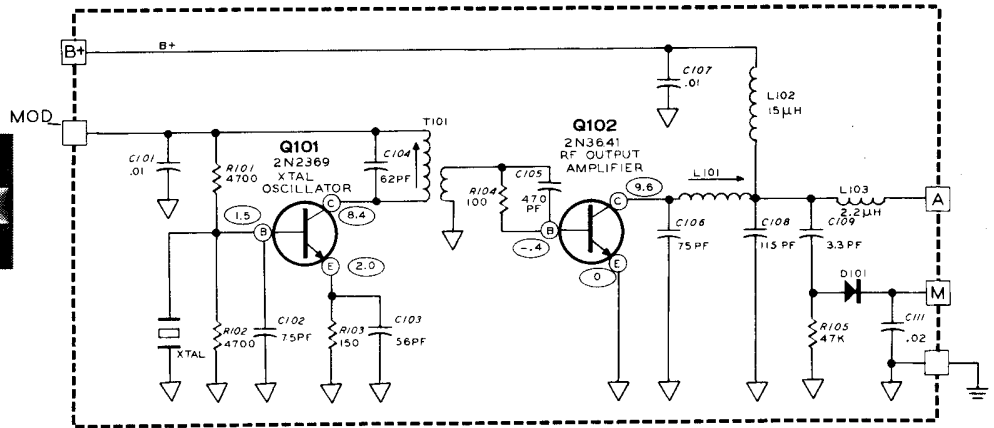

53 MHz BAND - RF CIRCUIT BOARD

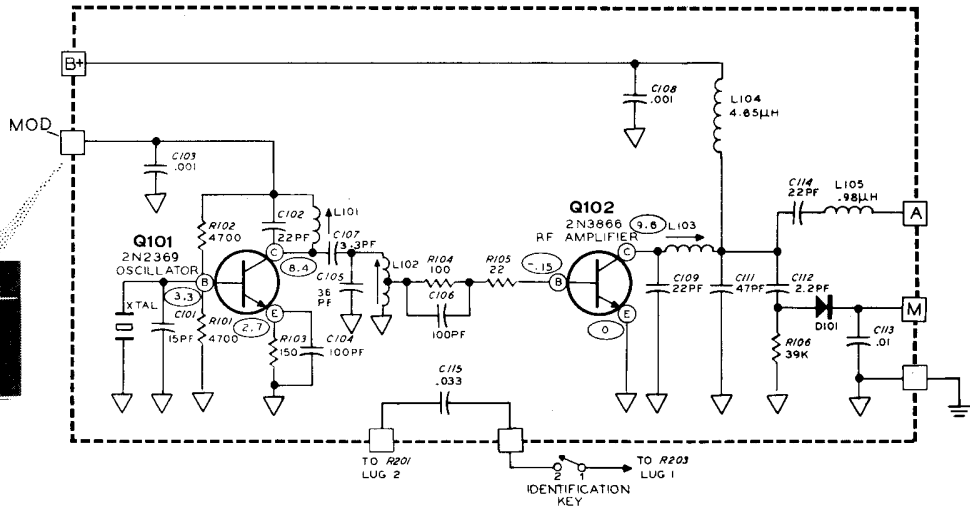

72 MHz BAND - RF CIRCUIT BOARD

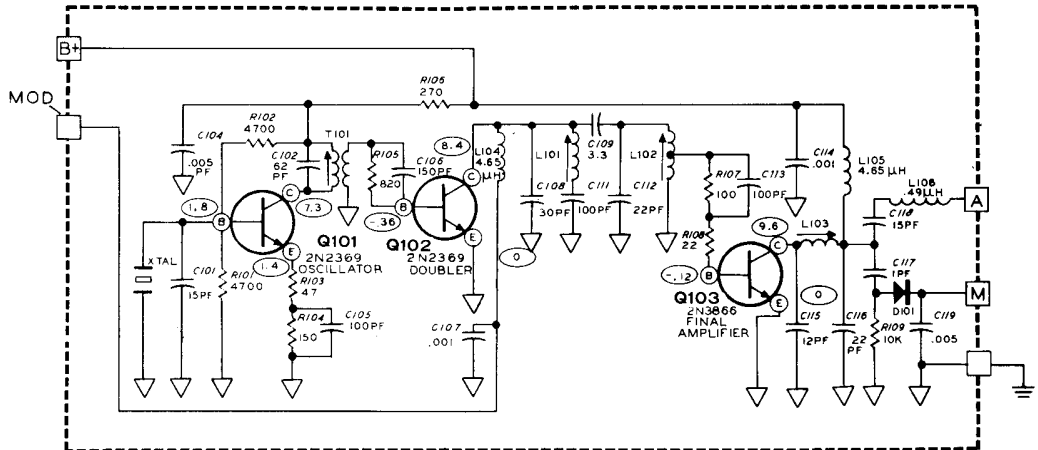

7, 53, AND 72 MHz BANDS OF TRANSMITTER CIRCUIT EACH A DIFFERENT SCHEMATIC. SCHEMATICS AT RIGHT.

IS USED ONLY WITH THE 27 BAND TRANSMITTER. THE R BANDS USE A JUMPER WIRE NO CAPACITOR. R204 IS USED ON THE 72 MHz BAND.

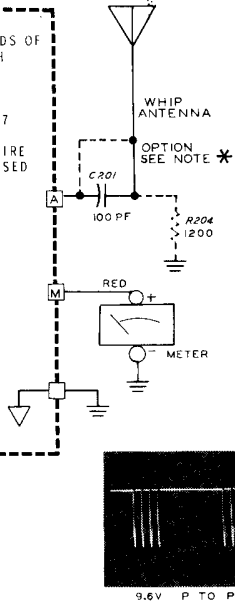

FOLLOWING GROUPS:

CIRCUIT BOARD.
BOARD.

HERWISE, RESISTOR VALUES

ED OTHERWISE.

GE MEASUREMENT, TAKEN
POINT INDICATED TO CHASSIS

IT BOARD X-RAY VIEWS FOR THE

