



home theatre
3000 Series

Model HTB2 Subwoofer

GB Installation Manual

F Manuel d'installation

D Bedienungsanleitung

I Manuale d'installazione

ES Manual de instalación

P Manual de instalação

NL Installatie

DK Installationsanvisning

CN

INTRODUCTION

(F) Utilisation (F) Introduction (D) Einleitung (I) Introduzione (ES) Introducción (P) Introdução (NL) Inleiding (DK) Introduktion (CN)

- GB** Thank you for purchasing the KEF Model HTB2 powered subwoofer. We are confident that your HTB2 will provide reliable, high performance sound for many years to come. Please read this manual fully before you attempt any connections to the HTB2.
- F** KEF vous remercie de votre achat d'un subwoofer modèle HTB2. Nous sommes convaincus que votre haut-parleur HTB2 vous procurera un son fiable et de hautes performances pendant de longues années. Veuillez lire intégralement le présent manuel avant de procéder à des connexions quelconques.
- D** Vielen Dank für den Kauf des aktiven Subwoofers KEF HTB2. Wir sind davon überzeugt, daß Ihr HTB2 lange Zeit zuverlässig funktionieren und eine hohe Klangqualität gewährleisten wird. Lesen Sie bitte diese Anleitung sorgfältig durch, bevor Sie Ihr Gerät anschließen.
- I** Vi ringraziamo per aver dato la Vs preferenza al subwoofer attivo KEF, apparecchio affidabile e dalle elevate prestazioni. Prima di effettuare i collegamenti si consiglia di leggere per intero il presente manuale.
- ES** Le damos las gracias por haber adquirido el altavoz para graves KEF Modelo HTB2. Estamos seguros de que el HTB2 le proporcionará un sonido de calidad y de altas prestaciones durante muchos años. Por favor, lea este manual antes de intentar conectar y poner en funcionamiento el altavoz.
- P** Obrigado por ter escolhido o modelo KEF HTB2: um subwoofer com amplificador. Acreditamos que o seu HTB2 lhe oferecerá durante muitos anos, um som de alta fidelidade. Leia, por favor, este manual integralmente antes de tentar quaisquer conexões com o HTB2.
- NL** Wij danken u van harte voor uw aankoop van de actieve subwoofer KEF Model HTB2. Wij zijn ervan overtuigd dat uw subwoofer u jarenlang hoogwaardig luisterplezier zal geven. Lees eerst deze handleiding aandachtig door alvorens u de subwoofer HTB2 aansluit.
- DK** Tillykke med erhvervelsen af din KEF model HTB2 subwoofer med forstærker. Vi er overbevist om, at din HTB2 vil give dig en stabil high performance sound i mange år fremover. Gennemlæs venligst denne manual inden du foretager nogen tilslutning til din model HTB2.
- CN**

USING THE MANUAL

(F) Utilisation du manuel (D) Verwendung der Anleitung (I) Uso del manuale (ES) Uso del manual (P) Utilização do manual (NL) Gebruik van de handleiding (DK) Brug af manualen (CN)

- GB** The following icons are used throughout this manual to help you safely install your new speakers. **Please follow them carefully.**
- F** Les icônes reprises ci-après sont utilisées dans tout le manuel de manière à vous aider à installer vos nouveaux haut-parleurs en toute sécurité. **Veillez suivre scrupuleusement leur signification.**
- D** Die folgenden Symbole finden Sie in der gesamten Anleitung. Sie erleichtern eine sichere Installation Ihrer neuen Lautsprecher. **Bitte achten Sie sorgfältig auf die Symbole.**
- I** Le seguenti icone usate nel manuale aiutano ad installare correttamente i diffusori. **Si raccomanda di seguirle con attenzione.**
- ES** Se utilizan los iconos siguientes en este manual para ayudarle a instalar con seguridad sus nuevos altavoces. **Signalas cuidadosamente.**
- P** Os seguintes ícones são utilizados no manual afim de o ajudarem a instalar com segurança as suas novas colunas. **Siga-os cuidadosamente.**
- NL** De hierna volgende pictogrammen worden in de hele handleiding gebruikt om u te helpen bij het veilig aansluiten en gebruiken van uw nieuwe luidsprekers. **Volg de instructies steeds nauwgezet op.**
- DK** Følgende symboler benyttes i denne manual, for at hjælpe dig med sikker installation af dine højttalere. **Følg dem nøje.**
- CN**



(GB) Correct
(F) Correct
(D) Richtig
(I) Corretto
(ES) Correcto
(P) Correcto
(NL) Juist
(DK) Korrekt
(CN)



(GB) Wrong
(F) Incorrect
(D) Falsch
(I) Errato
(ES) Incorrecto
(P) Errado
(NL) Fout
(DK) Forkert
(CN)



(GB) Read
(F) 'A lire'
(D) Lesen
(I) Leggere
(ES) Lea
(P) Leia
(NL) Lees
(DK) Gennemlæs
(CN)



(GB) Caution/Warning
(F) Attention/Avertissement
(D) Achtung / Warnung
(I) Attenzione/Avvertenza
(ES) Precaución/Atención
(P) Atenção/ Aviso
(NL) Opgelet/Waarschuwing
(DK) Forsigtigt / Advarsel
(CN)



(GB) Electrical Warning
(F) Danger électrique
(D) Warnung: Gefährliche Spannungen
(I) Rischii elettrici
(ES) Advertencia eléctrica
(P) Aviso sobre a parte eléctrica
(NL) Opgelet! Elektriciteit!
(DK) Elektrisk advarsel
(CN)



(GB) Option
(F) Option
(D) Option
(I) Opzione
(ES) Opción
(P) Opcional
(NL) Optie
(DK) Tilbehør
(CN)



(GB) Positive/RED
(F) Positif / ROUGE
(D) Positiv / ROT
(I) Positivo / ROSSO
(ES) Positivo / ROJO
(P) Positivo/Vermelho
(NL) Positief / ROOD
(DK) Positiv / RØD
(CN)



(GB) Negative/BLACK
(F) Négatif / NOIR
(D) Negativ / SCHWARZ
(I) Negativo / NERO
(ES) Negativo / NEGRO
(P) Negativo/ Preto
(NL) Negatief / ZWART
(DK) Negativ / SORT
(CN)



(GB) Switch off appliance
(F) Couper l'appareil
(D) Gerät abschalten
(I) Disattivazione dell'ap parecchio
(ES) Interruptor del aparato
(P) Interruptor para desligar
(NL) Het toestel uitschakelen
(DK) Afbryd apparatet
(CN)

SAFETY INFORMATION

(F) Utilisation du manuel (D) Verwendung der Anleitung (I) Uso del manuale (ES) Uso del manual (P) Utilização do manual (NL) Gebruik van de handleiding (DK) Brug af manualen (CN)

WARNING

TO REDUCE THE RISK OF FIRE OR ELECTRICAL SHOCK, DO NOT EXPOSE THIS APPLIANCE TO RAIN OR MOISTURE



- A combined mains power input lead and country specific mains plug is provided.
- Check before connecting to your local mains supply that the local supply voltage is the same as that marked on the rear panel. If it is not, check with your supplier before proceeding.

Explanation of Graphical Symbols



The lightning flash with arrowhead symbol, within an equilateral triangle, is intended to alert the user to the presence of uninsulated “dangerous voltage” within the products enclosure that may be of a sufficient magnitude to constitute a risk of electrical shock to persons.



The exclamation mark within an equilateral triangle is intended to alert the user to the presence of important operating and maintenance (servicing) instructions in the literature accompanying the appliance.

WARNING:

Due to the mains switch being located on the rear panel, the apparatus must be located in an open area without anything obstructing access to the mains switch.

IMPORTANT SAFETY INSTRUCTIONS

(F) Utilisation du manuel (D) Verwendung der Anleitung (I) Uso del manuale (ES) Uso del manual (P) Utilização do manual (NL) Gebruik van de handleiding
(DK) Brug af manualen (CN)

Please take heed of the following before using the KEF Model HTB2. Note also that the word “appliance” shall refer to the KEF HTB2 subwoofer, or any part of it.

1. **Read Instructions** – All the Safety and Operating Instructions should be read before the appliance is operated.
2. **Retain Instructions** – The Safety and Operating Instructions should be retained for future reference.
3. **Heed Warnings** – All warnings on the appliance and in the Operating Instructions should be adhered to.
4. **Follow Instructions** – All Operating and Use Instructions should be followed. Only use attachments/accessories specified by the manufacturer.
5. **Important** – Do not defeat the safety purpose of the polarized or grounding typeplug. The third prong is provided for your safety.
If the provided plug does not fit into your outlet, consult an electrician for replacement of the obsolete outlet. Refer all servicing to a qualified service personnel. Servicing is required for any damaged parts such as power-supply cord or plug
6. **Water and Moisture** – The appliance should not be used in or near water - for example, near a bathtub, washbowl, kitchen sink, laundry tub, in a wet basement, or near a swimming pool, and the like. The apparatus shall not be exposed to dripping or splashing. Care should be taken so that objects containing liquids are not placed upon or spilled into the enclosure through openings and that no objects filled with liquids, such as a vase, shall be placed on apparatus..
7. **Ventilation** – The appliance should be situated so that its location or position does no interfere with its proper ventilation. For example, the appliance should not be situated on a bed, sofa, or similar surface that may block any ventilation openings.
8. **Heat** – The appliance should be situated away from heat sources such as radiators, heat registers, stoves or other appliances (including amplifiers) that produce heat.
9. **Power Sources** – The appliance should be connected to a power supply only of the type described in the operating instructions or as marked on the appliance and it shall remain readily operable. Mains plug is used as the disconnect device. To be completely disconnected from the power input, the mains plug of the apparatus must be disconnected from the mains completely.
10. **Power-cord Protection** – Power supply cords should be routed so that they are not likely to be walked on or pinched by items placed upon or against them, paying particular attention to cords at plugs, convenience receptacles and the point where they exit from the appliance. The main plug should not be obstructed OR should be easily accessed during intended use.
11. **Attachments and Accessories** – Use only attachments/accessories specified by the manufacturer.
12. **Non-use Periods** – Unplug this apparatus during lightning storms or when unused for long periods of time.
13. **Damage Requiring Service** – The appliance should be serviced by qualified service personnel when:
 - a) The power supply cord or the plug has been damaged; *or*
 - b) Objects have fallen or liquid has been spilled into the appliance; *or*
 - c) The appliance has been exposed to rain; *or*
 - d) The appliance does not appear to operate normally or exhibits a marked change in performance; *or*
 - e) The appliance has been dropped or the enclosure damaged.
14. **Servicing** – The user shall not attempt to service the appliance beyond that described in the Operating Instructions. All other servicing should be referred to qualified service personnel.

IMPORTANT SAFETY INSTRUCTIONS

(F) Utilisation du manuel (D) Verwendung der Anleitung (I) Uso del manuale (ES) Uso del manual (P) Utilização do manual (NL) Gebruik van de handleiding
(DK) Brug af manualen (CN)

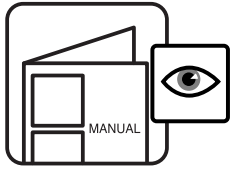

- (GB) Follow this manual carefully for best results from speakers.
- (F) Afin de tirer les meilleurs résultats des haut-parleurs, veuillez suivre scrupuleusement les instructions reprises dans le présent manuel.
- (D) Für optimale Ergebnisse mit Ihrem Lautsprecher befolgen Sie diese Anleitung
- (I) Per ottenere le migliori prestazioni dai diffusori seguire le istruzioni contenute nel presente manuale
- (ES) Siga las instrucciones de este manual para obtener los mejores resultados de los altavoces
- (P) Siga este manual atentamente para obter o melhor resultado das colunas
- (NL) Volg terwille van een optimaal resultaat de instructies nauwkeurig op.
- (DK) Følg denne manual omhyggeligt for at opnå det bedste resultat fra højttalerne
- (CN)

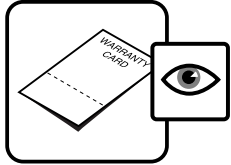

- (GB) Read and return warranty card.
- (F) Veuillez lire et renvoyer la carte de garantie.
- (D) Lesen Sie die Garantiekarte und senden Sie sie ausgefüllt zurück.
- (I) Si prega di restituire la scheda di garanzia, previa attenta lettura
- (ES) Lea y envíenos la tarjeta de garantía
- (P) Leia e devolva o cartão de garantia
- (NL) U kunt na lezing en invulling de garantiekarta aan de importeur sturen.
- (DK) Gennemlæs og send garantibeviset tilbage
- (CN)

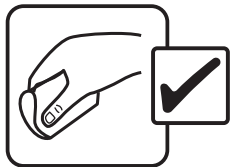

- (GB) Clean with a dry lint free cloth.
- (F) Nettoyer à l'aide d'un chiffon humide, non pelucheux.
- (D) Mit einem angefeuchteten, nicht fuselnden Tuch abwischen.
- (I) Pulire con un panno umido non sfilacciato
- (ES) Limpie con un paño húmedo
- (P) Limpe com um pano húmido sem pêlos
- (NL) Reinigen met een vochtige niet pluizende doek
- (DK) Rengør med en fugtig klud, der ikke frugger
- (CN)

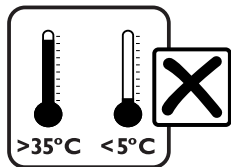

- (GB) Avoid temperature extremes.
- (F) Eviter les températures extrêmes.
- (D) Extreme Temperaturen vermeiden.
- (I) Evitare temperature troppo alte o troppo basse.
- (ES) Evite temperaturas extremas
- (P) Evite temperaturas extremas
- (NL) Vermijd extreme temperaturen.
- (DK) Undgå ekstreme temperaturer
- (CN)

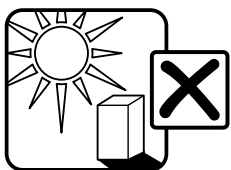

- (GB) Avoid direct sunlight.
- (F) Eviter l'exposition directe aux rayons du soleil.
- (D) Direktes Sonnenlicht vermeiden.
- (I) Evitare l'esposizione diretta ai raggi del sole
- (ES) Evite la luz directa del sol
- (P) Evite a exposição directa à luz do sol
- (NL) Vermijd rechtstreeks zonlicht
- (DK) Undgå direkte sollys
- (CN)



- (GB) Do not use spirit based cleaners.
- (F) Ne pas utiliser d'agents nettoyants à base d'alcool.
- (D) Keine alkoholhaltigen Reinigungsmittel verwenden.
- (I) Non utilizzare prodotti a base di alcol
- (ES) No use limpiadores con base de alcohol
- (P) Não utilize produtos de limpeza à base de álcool
- (NL) Gebruik geen reinigingsproducten op basis van alcohol
- (DK) Brug ikke rengøringsmidler med alkohol
- (CN)

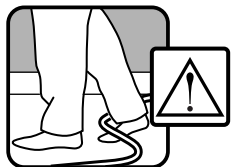

- (GB) SAFETY NOTICE! trailing cables are dangerous, secure all cables.
- (F) NOTE DE SECURITE ! Les câbles de haut-parleurs traînant sur le sol peuvent être source de danger. Fixer tous les câbles.
- (D) SICHERHEITSHINWEIS ! Herumliegende Lautsprecherkabel sind eine Gefahrenquelle. Bitte alle Lautsprecherkabel sorgfältig verlegen.
- (I) NOTA PER LA SICUREZZA: i cavi di uscita dei diffusori possono essere pericolosi se non sistemati in un posto sicuro.
- (ES) ¡ATENCIÓN! los cables de conexión sueltos de los altavoces son peligrosos. Fíjelos
- (P) Precauções de segurança! Os cabos das colunas espalhados são perigosos, fixe todos os cabos
- (NL) VOOR UW VEILIGHEID! Loshangende luidsprekerkabels zijn gevaarlijk! De kabels steeds op een veilige plaats leggen.
- (DK) BEMÆRK! skarpe knæk og slid på højttalerledningerne er farlig, de skal fastgøres.
- (CN)

UNPACKING

(F) Déballage (D) Auspacken (I) Apertura della confezione (ES) Desembalaje (P) Desembalagem (NL) Het toestel uitpakken (DK) Udpakning (CN)

1

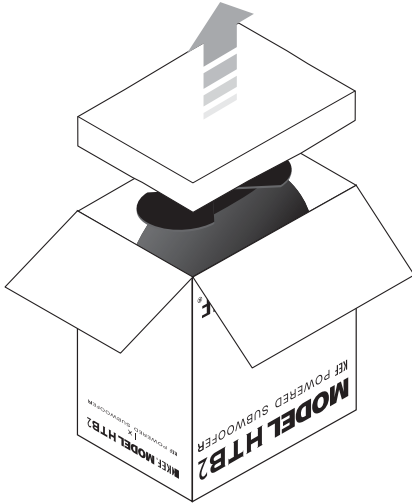

2



3

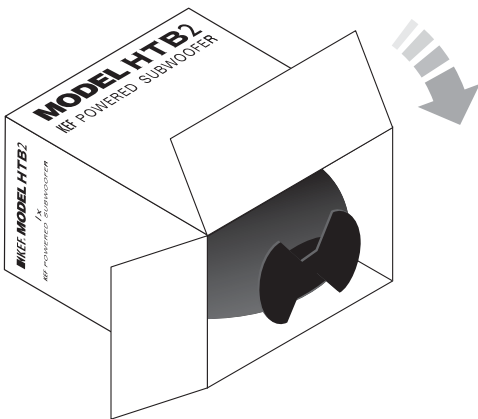

4

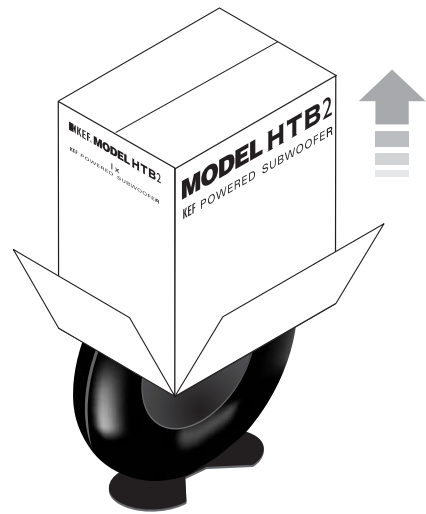

5

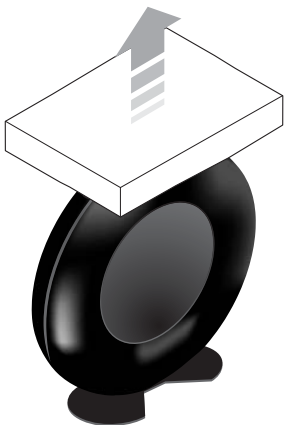

6



CONTROLS AND SOCKETS

(F) Commandes et prises (D) Bedienungselemente und Anschlüsse (I) Comandi e prese (ES) Controles y conexiones (P) Comandos e fichas (NL) Regelaars en aansluitingen (DK) Betjeningsknapper og stik (CN)

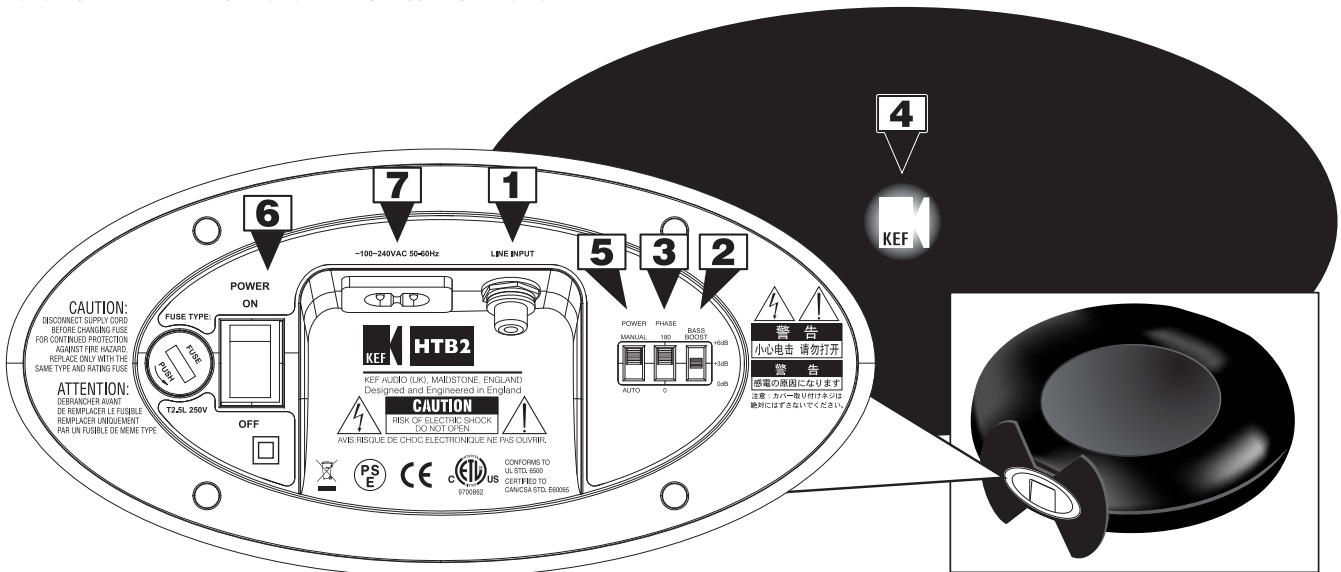

Model HTB2 Rear Panel

1. Line in input socket
2. Bass Boost
3. Phase control
4. Mains indicator light

Power ON Power OFF

5. Auto/manual switch
6. 'ON/OFF' switch (vacation switch)
7. AC power input 100 - 240V AC 50 - 60Hz

Panneau arrière du modèle HTB2 Subwoofer.

1. Prises d'entrée auxiliaire
2. Bass Boost
3. Contrôle de phase
4. Témoin de mise sous tension

MARCHE ARRÊT

5. Commutateur Automatique/Manuel
6. Commutateur 'MARCHE/ARRÊT' (Interrupteur Vacances)
7. Entrée d'alimentation en c.a. 100 - 240V AC 50 - 60Hz

Modell HTB2 Subwoofer Rückseite

1. Line in-Eingangsbuchsen
2. Bassanhebung
3. Phasensteuerung
4. Betriebsanzeige

Gerät eingeschaltet Gerät ausgeschaltet

5. Auto/Manual-Schalter
6. Netzschalter (EIN/AUS) (Urlaubsschalter)
7. Netzstromeingang 100 - 240V AC 50 - 60Hz

Modello HTB2 Subwoofer Pannello posteriore

1. Prese ingresso linea
2. Bass Boost
3. Interruttore di fase
4. Indicatore luminoso di alimentazione

Acceso Spento

5. Standby
6. Interruttore ON/OFF (Interruttore Vacanze)
7. Alimentazione a c.a. 100 - 240V AC 50 - 60Hz

Panel trasero del Modelo HTB2 Subwoofer

1. Línea en el zócalo de entrada
2. Realce de graves
3. Controllo di fase
4. Luz indicadora de conexión a red

Encendido Power OFF (desconectado)

5. Interruttore Auto/Manual (automatico/manuale)
6. Interruttore ON/OFF (botón Vacaciones)
7. Entrada de corriente (CA) 100 - 240V AC 50 - 60Hz

Painel traseiro do Modelo HTB2 Subwoofer

1. Tomadas de entrada de linha
2. Reforço de Baixos
3. Controlo de fase
4. Luzes indicadoras de tensão

Power On Desligado

5. Interruptor Auto/Mamua
6. Interruptor "ON/OFF" (Interruptor Férias)
7. Entrada de corrente AC 100 - 240V AC 50 - 60Hz

HTB2 Subwoofer achterpaneel

1. lijn-niveau ingangbussen
2. Bass Boost
3. Fases regelaar
4. Aan/uit indicatielampje

Netschaklaar Toestel UIT

5. Auto/handbedienings schakelaar
6. Netschakelaar (Vakantiestand)
7. Aansluiting voor netkabel 100 - 240V AC 50 - 60Hz

HTB2 Subwoofer bagside

1. Bøsninger for linieindgange
2. Bass Boost
3. Fase-regulering
4. Indikator for net spænding

TÆNDT SLUKKET

5. Omskifter for Auto/Manual drift
6. TÆND/SLUK afbryder (Hoved afbryder)
7. AC net indgang 100 - 240V AC 50 - 60Hz

CONNECTIONS

(F) Connexions (D) Anschlüsse (I) Collegamenti (ES) Conexiones (P) Ligações (NL) Aansluitingen (DK) Forbindelser (CN)

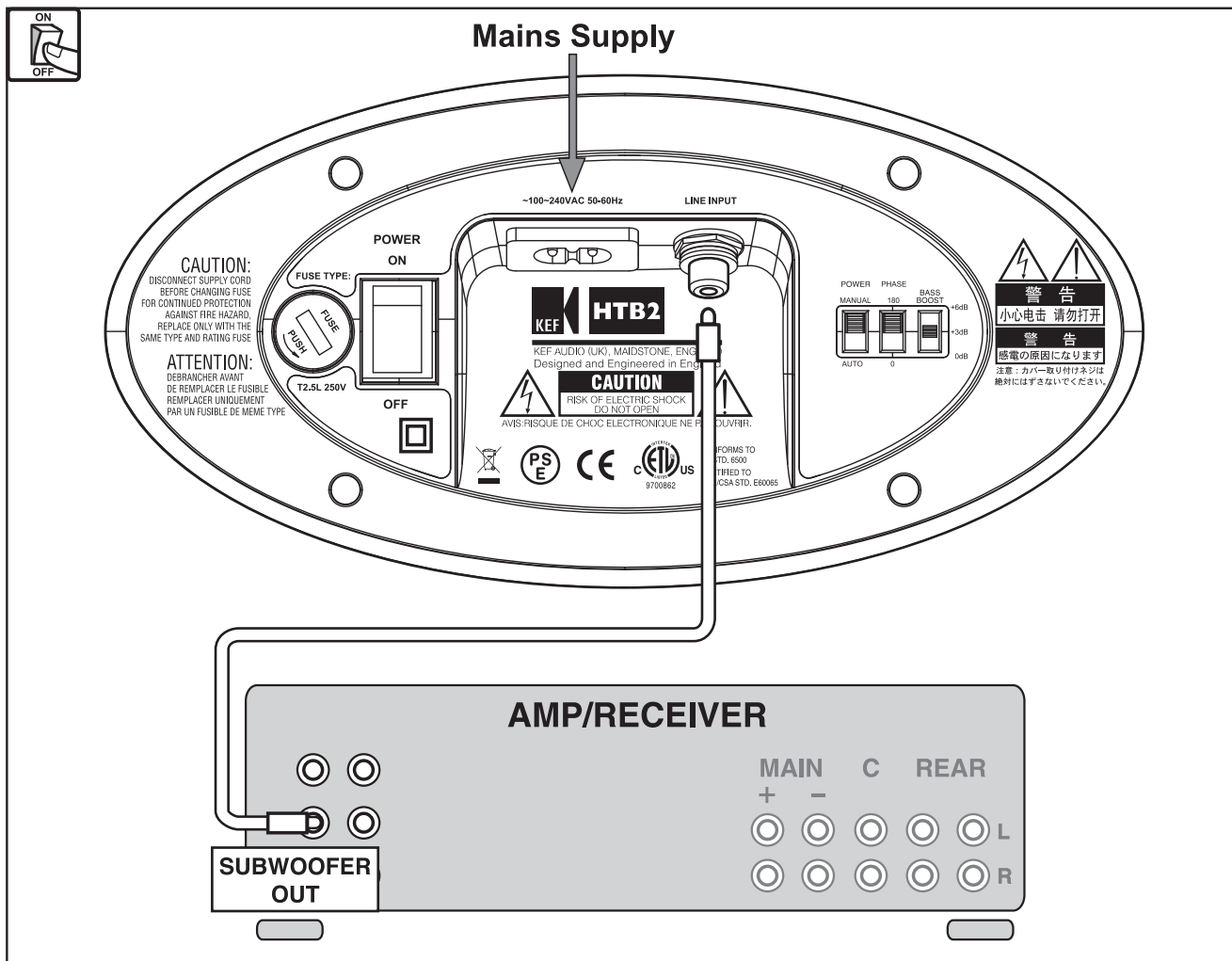

Line Level - connected to amplifier subwoofer Output (Set subwoofer frequency on the receiver/processor to 80Hz and "speakers to small" when using model HTS3001 speakers).

Nível de Linha - Conectado à saída do subwoofer do amplificador (Ajuste a frequência do subwoofer no amplif. sintonizador/processador para 80Hz e "speakers para small" quando usa o modelo de colunas HTS3001).

Niveau ligne - connecté à la sortie "subwoofer output" (regler la fréquence sur 80Hz et les haut-parleurs sur "small" (petit) lorsque vous utilisez des haut-parleurs KEF HTS3001)

Lijn Niveau - aangesloten op de subwoofer uitgang op de processor/versterker (Kies in het menu van de processor/versterker voor 80 Hz als overgangsfrequentie voor de subwoofer en selecteer 'kleine luidsprekers' wanneer u HTS3001 satellieten toepast).

Niederpegel-Anschluss - Wird an den Subwoofer-Ausgang des Verstärkers angeschlossen (Stellen Sie die Subwoofer-Frequenz Ihres Receivers/Prozessors auf 80 Hz ein, und wählen Sie die Lautsprecher-Einstellung "klein", wenn Sie HTS3001-Lautsprecher verwenden).

Line Level - tilsluttet til "Subwoofer Output" på forstærker/receiver (sæt delefrekvens/subwoofer-frekvens til 80Hz og højttalere til "små" når HTS3001 højttalere anvendes).

Line Level - collegato all'uscita sub-woofer dell'amplificatore o del processore (che, nel caso di utilizzo di diffusori acustici HTS3001, deve essere impostato su: frequenza di taglio per il sub-woofer 80 Hz, "speakers small").

Nivel de línea - Conectado a la salida de subwoofer del amplificador (Ajuste la frecuencia del subwoofer en un receptor/procesador a 80 Hz y los altavoces como "small-pequeños" cuando use los altavoces HTS3001)

POSITIONING

(F) Positionnement (D) Aufstellung (I) Posizionamento (ES) Posicionamiento (P) Posicionamento (NL) Plaats en aansluiting van het netsnoer (DK) Placering (CN)

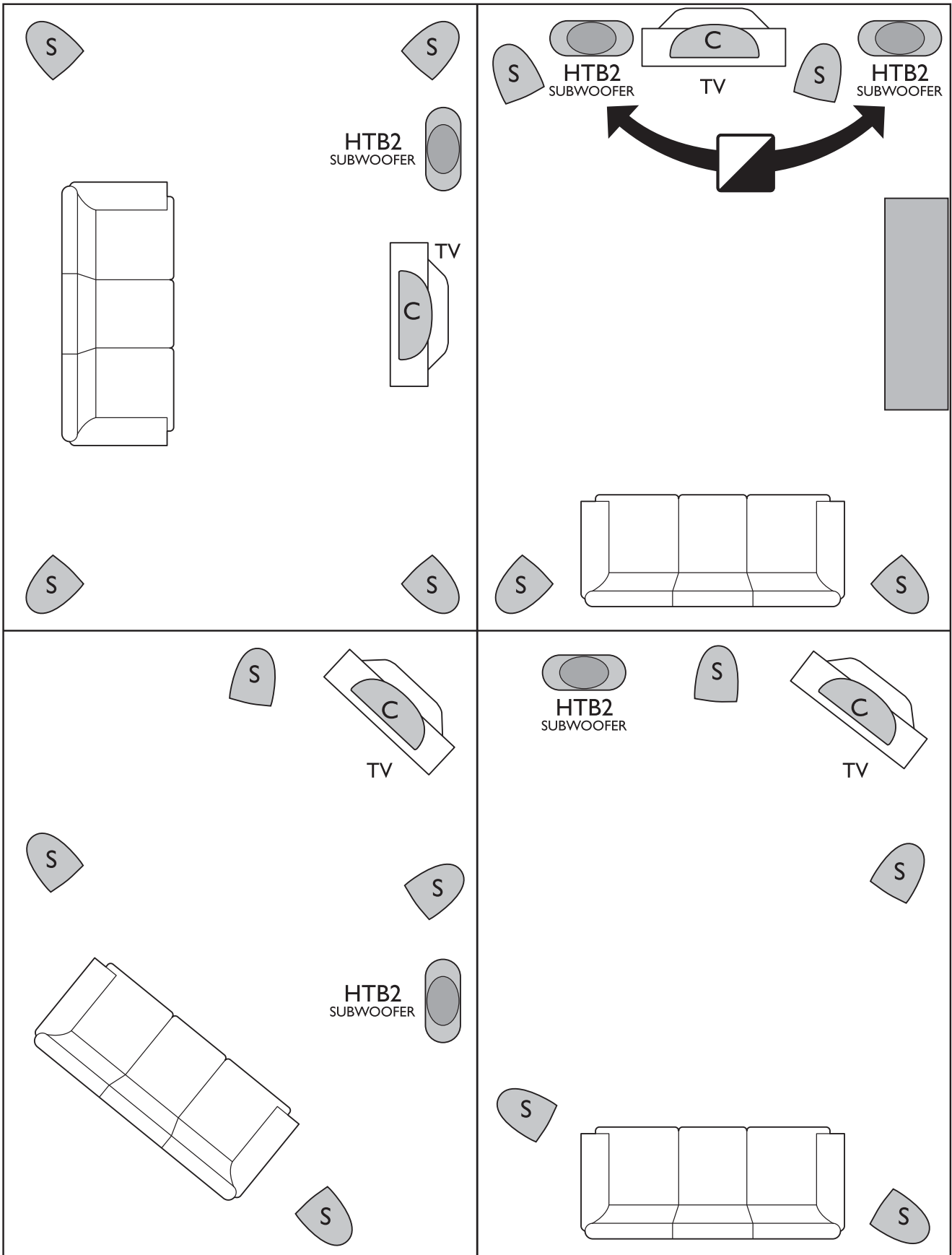

POSITIONING

(F) Positionnement (D) Aufstellung (I) Posizionamento (ES) Posicionamiento (P) Posicionamento (NL) Plaats en aansluiting van het netsnoer (DK) Placering (CN)

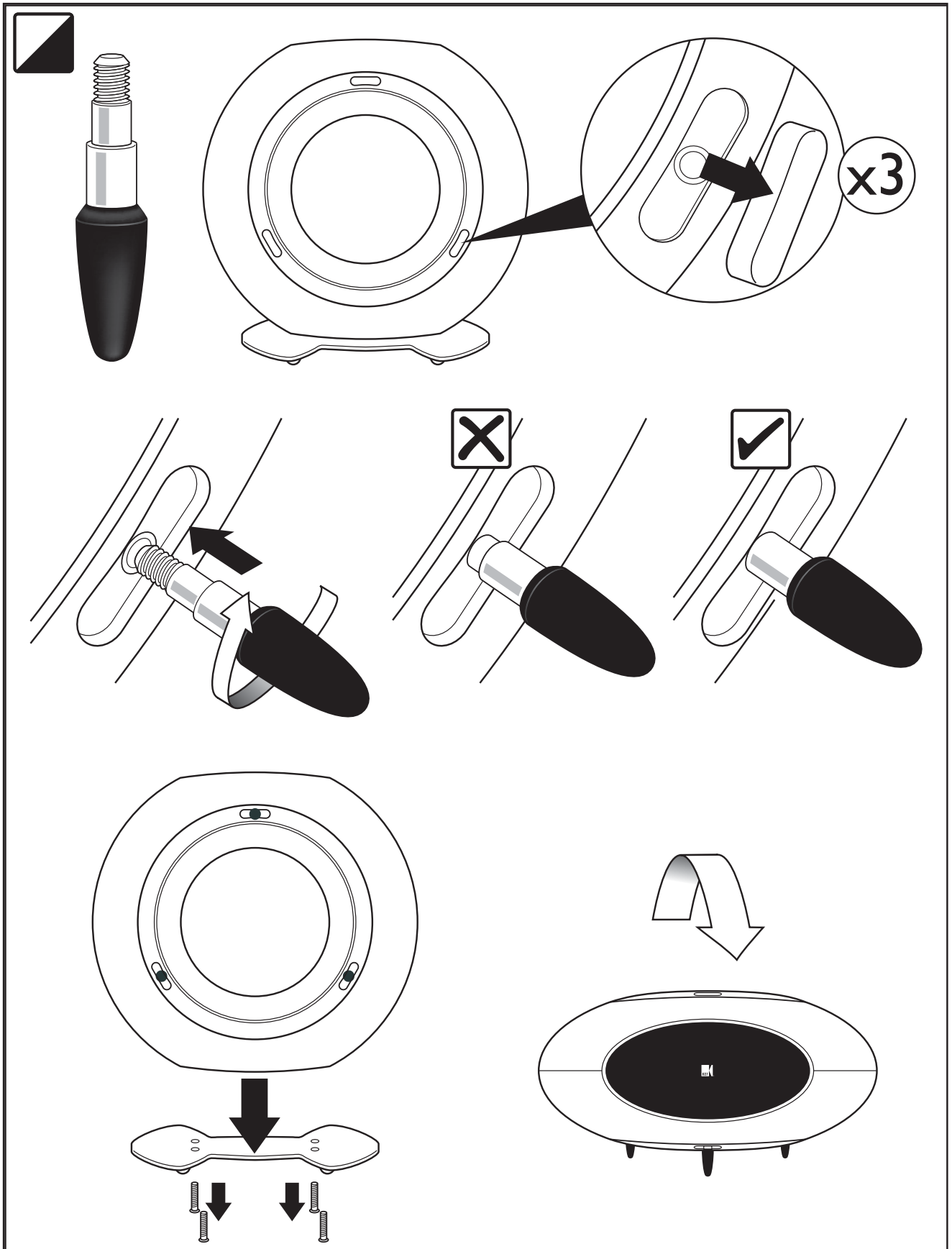

ADJUSTING THE CONTROLS

(F) Déballage (D) Einstellen der Regler (I) Apertura della confezione (ES) Desembalaje (P) Desembalagem (NL) Het toestel uitpakken (DK) Udpakning (CN)

Bass Boost

The bass boost control is intended to adjust the response of the subwoofer to compensate for room conditions and user preferences. Boost is switchable between 0, +3 and +6dB at around 40Hz.

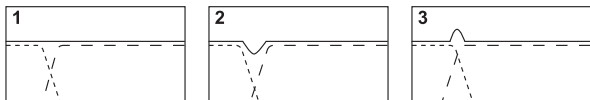

PLEASE NOTE:

Volume Control

Volume control is implemented in the source equipment.

Auto/Manual Switch

In Auto mode the unit will remain in standby until a signal is sensed.

In Manual mode the unit will remain on even when no signal is present.

Phase Control

The phase control will normally be set at 0° but more output level can sometimes be achieved in the 180° position, particularly when the subwoofer is far away from the satellite speakers.

Bass Boost

La fonction "bass Boost" permet d'adapter la réponse au local ou aux préférences personnelles. Les basses peuvent être "poussées" pas par pas, 0,+3 et +6dB à +/- 40Hz



REMARQUE:

Contrôle de volume.

Le volume est contrôlé par l'amplificateur

Auto/Manual Schalter.

Im Manual Mode bleibt das Gerät eingeschaltet, auch wenn kein Signal empfangen wird.

Contrôle de phase

Le contrôle de phase sera normalement positionné sur 0°. Un niveau plus élevé de sortie peut toutefois être obtenu en position 180°, et ce plus particulièrement lorsque le subwoofer est éloigné des haut-parleurs satellites.

Bassanhebung

Die Einstellung der Bassanhebung erlaubt die Anpassung des Subwoofers an die Bedingungen des Raums und Ihrem persönlichen Geschmack.

Die Anhebung ist schaltbar in folgenden Stufen: 0 dB, +3 dB und +6 dB bei etwa 40 Hz.



BITTE BEACHTEN:

Lautstärkeregelung

Die Lautstärke wird vom angeschlossenen Verstärker/Prozessor geregelt. Im Auto Mode bleibt der Subwoofer in Stand-By, bis ein Signal empfangen wird.

Interrupteur manuel/auto.

Im Manual Mode bleibt das Gerät eingeschaltet, auch wenn kein Signal empfangen wird. Pegeleinstellung überprüfen und ggf. korrigieren.

Phasensteuerung

Der Phasensteuerung wird normalerweise auf 0° eingestellt. Allerdings kann manchmal in der Position 180° ein höherer Ausgangspegel erzielt werden, insbesondere, wenn der Subwoofer weit von den Satellitenlautsprechern entfernt ist.

Bass Boost

Mediante il selettore "bass boost" è possibile apportare piccole enfasi nella risposta in frequenza del sub-woofer, per compensare differenti situazioni ambientali o per preferenze personali. Le variazioni possibili sono +3 e +6 dB a circa 40 Hz.

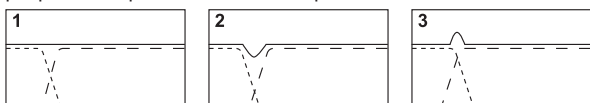

NOTA:

Controllo del volume

La regolazione del volume si effettua dall'unità di controllo.

Commutatore Auto/Manual

Auto: il sub-woofer rimane in standby, e si attiva quando riceve un segnale.

Manual: il sub-woofer resta sempre acceso, anche in assenza di segnale.

Interruttore di fase

In genere l'interruttore di fase viene impostato a 0° ma a volte si ottiene un maggior livello d'uscita nella posizione a 180°, particolarmente se il subwoofer è molto distante dagli altoparlanti secondari.

Realce de graves

El control de realce de graves permite ajustar la respuesta del subwoofer para compensar las condiciones de la sala y las preferencias del usuario. El realce se puede poner a 0, +3 y +6 dB en torno a 40Hz.

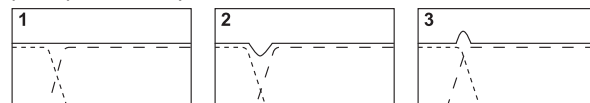

ATENCIÓN:

Control de Volumen

El control de volumen se implementa en el equipo fuente.

Comuntador Auto/Manual

En modo Auto la unidad quedará a la espera hasta detectar una señal.

En modo Manual la unidad permanecerá encendida incluso en ausencia de señal.

Controllo di fase

El Controllo di fase debe estar normalmente en 0°, pero algunas veces se puede obtener un mayor nivel de salida en la posición de 180°, especialmente cuando el altavoz de graves está alejado de los altavoces satélite.

Reforço de Baixos

O controlo de reforço de baixos destina-se a ajustar a resposta do subwoofer para compensar as condições de audição da sala e as preferências do utilizador. O reforço é comutável entre 0, +3 e +6dB na faixa dos 40Hz.



POR FAVOR NOTE:

Controlo de Volume

O controlo de volume é implementado no equipamento de fonte.

Interruptor Auto/Manual

No modo Auto a unidade permanecerá em standby até se sentir um sinal.

No modo Manual a unidade permanecerá ligada mesmo que não haja presença de sinal.

Controlo de fase

O controlo de fase será fixado normalmente a 0° mas algumas vezes pode-se conseguir um maior nível de saída numa posição a 180°, nomeadamente quando o subwoofer se encontra longe das colunas satélites.

Bass Boost

Bass Boost stelt u in staat om de karakteristiek van de subwoofer rond 40 Hz in te stellen op 0, +3 of +6 dB, ter compensatie voor akoestische omstandigheden of gebruikersvoorkeur.

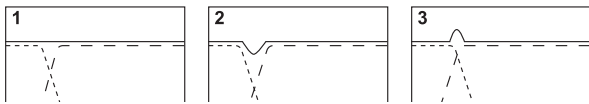

LET OP:

Volume regeling vindt plaats in de externe processor/versterker Auto/Manual schakelaar

In 'Auto' komt de subwoofer pas in actie wanneer hij audio signaleert.

In 'Manual' blijft de subwoofer actief, ook al signaleert hij geen audio..

Fase regelaar

De fases regelaar staat normaal gezien op 0°. Soms kunt u echter een hoger uitgangsniveau bereiken door de regelaar op 180° te zetten, vooral als de subwoofer ver weg staat van de satellietluidsprekers.

Bass Boost

Bass Boost justerer output fra subwooferen som kompenstation for storrelse af stue og brugerens praeferencer. "Boost" kan justeres trinvis mellem 0, +3 og +6dB omkring 40 Hz.

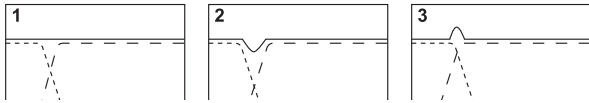

BEMAERK VENLIGST:

Volumekontrol

Volumekontrol foretages gennem den tilsluttede forstaerker/receiver.

Auto/Manual Switch

I "Auto" mode forbliver subwooferen i standby intil et signal registreres.

I "Manual" mode forbliver subwooferen taendt selv naar der intet signal er tilfoert fra forstaerken/receiveren.

Fase Regulering

Faseo regulering er normalt sat til 0° men større udgangsniveau kan nogle gange opnås i 180° positionen, specielt når subwooferen er anbragt langt fra satellithøjttalerne.

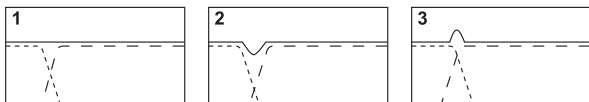



FAULT FINDING

(F) Utilisation du manuel (D) Fehlerbehandlung (I) Uso del manuale (ES) Uso del manual (P) Utilização do manual (NL) Gebruik van de handleiding (DK) Brug af manualen (CN)

FAULT	REMEDY
Mains indicator light does not come on.	Check that the subwoofer is plugged into the mains supply and that any switches are on. Check any fuses (including the plug) or circuit breakers on the mains supply which may effect the power to the subwoofer. Contact your dealer for further advice.
If the mains indicator light is on but no sound comes from the subwoofer.	 Check and adjust the level control setting in your AV amplifier/receiver. Check that the output sockets on the source equipment are correctly switched and adjusted to provide sufficient level to drive the subwoofer. Check that all connections between the subwoofer and the source equipment are correct and adjust as necessary.
If there is still no sound.	Contact your dealer for further advice.

PROBLEME	REMEDE
Le témoin indicateur de mise sous tension ne s'allume pas.	Vérifier que la fiche du subwoofer est bien branchée sur le secteur et que les commutateurs sont positionnés sur 'ON'. Vérifier tous les fusibles (ainsi que la fiche) circuit d'alimentation du subwoofer. Pour de plus amples conseils, adressez-vous à votre revendeur.
Le témoin indicateur de mise sous tension est allumé mais aucun son ne provient du subwoofer.	 Vérifiez et ajustez le réglage de volume de votre récepteur/amplificateur audio-video. Vérifier que les prises de sortie de l'équipement source sont correctement commutées et procéder à un réglage de manière à obtenir un niveau suffisant pour le subwoofer. Vérifier que toutes les connexions entre le subwoofer et l'équipement source sont correctes et procéder, si nécessaire, à la correction.
Le subwoofer n'émet toujours aucun son.	Pour de plus amples conseils, adressez-vous à votre revendeur.

FEHLERMELDUNG	FEHLERBESEITIGUNG
Betriebsanzeige leuchtet nicht auf.	Vergewissern Sie sich, daß der Subwoofer an das Stromnetz angeschlossen ist. Überprüfen Sie (z.B. mit irgendeinem anderen Gerät), ob an der betreffenden Netzsteckdose Spannung anliegt. Bitte wenden Sie sich an Ihren Fachhändler.
Betriebsanzeige leuchtet, jedoch kein Ausgangssignal aus dem Subwoofer.	 Überprüfen und korrigieren Sie ggf. die Pegelinstellungen Ihres AV-Verstärkers/Receivers Überprüfen Sie, ob der entsprechende Niederpegel-Ausgang am Verstärker aktiviert ist und so eingestellt ist, daß ein ausreichender Pegel an den Subwoofer übertragen wird. Vergewissern Sie sich, daß alle Anschlußkabel bzw. -stecker fest und ordnungsgemäß sitzen. Tauschen sie ggf. die Anschlußkabel aus.
Immer noch kein Ausgangssignal aus dem Subwoofer.	Bitte wenden Sie sich an Ihren Fachhändler.

ANOMALIA	AZIONE
La spia di alimentazione non si accende.	Verificare che il subwoofer sia collegato all'alimentazione di corrente e che gli eventuali interruttori presenti siano su ON. Controllare gli eventuali fusibili (spina compressa) o sezionatori sull'alimentazione che possano influenzare l'alimentazione del subwoofer. Per ulteriori informazioni rivolgersi al rivenditore.
Se la spia di alimentazione è accesa ma non arriva alcun suono dal subwoofer.	 Verificare il controllo di livello (volume) dell'amplificatore. Verificare che le uscite della sorgente (pre o finale) siano correttamente impostate, in modo da garantire un adeguato livello al subwoofer. Verificare che tutti i collegamenti tra il subwoofer e la sorgente siano stati realizzati in modo appropriato e modificarli se necessario.
Se persiste l'assenza del suono.	Per ulteriori informazioni rivolgersi al rivenditore.

SINTOMA	REMEDIO
La luz indicadora de red no se ilumina.	Compruebe que el altavoz de graves está conectado a la red y que los interruptores están activados. Compruebe los fusibles o disyuntores de la red que puedan afectar a la falta de funcionamiento del altavoz. Póngase en contacto con el proveedor del equipo para obtener asesoramiento.
Si la luz indicadora de red está iluminada pero el altavoz de graves no suena.	 Compruebe y ajuste el control de nivel. Compruebe que las clavijas de salida del equipo principal están correctamente conectadas y ajústelas para proporcionar potencia suficiente para que funcione el altavoz de graves. Compruebe que todas las conexiones entre el altavoz de graves y el equipo principal (fuente) están correctas y ajústelas según sea necesario.
Si sigue sin emitir sonido.	Póngase en contacto con el proveedor del equipo para obtener asesoramiento.

FALLHAS	SOLUÇÕES
O indicador luminoso de tensão não se acende.	Verifique se o subwoofer está ligado à corrente e se todos os interruptores estão ligados. Verifique todos os interruptores (incluindo a tomada) ou corta-circuitos da tomada que possam afectar a chegada de corrente ao subwoofer. Contacte o seu fornecedor para mais conselhos.
Se o indicador luminoso de tensão está aceso mas não há som do subwoofer.	 Verifique e ajuste o controlo de nível no seu amplificador/amplif.sintonizador AV. Verifique se as fichas de saída do equipamento principal estão correctamente ligadas e ajustadas para fornecerem um nível suficiente de energia ao subwoofer. Verifique se todas as conexões entre o subwoofer e o equipamento principal estão correctas e ajustadas convenientemente.
Se ainda não há som.	Contacte o seu fornecedor para mais conselhos.

STORING	VERHELPEN VAN DE STORING
Het aan/uit indicatielampje wil niet branden.	Controleer of het netsnoer van de subwoofer aangesloten is op een stopcontact en de aan/uit-schakelaar ingeschakeld is. Controleer de smeltzekeringen of stroomonderbrekers van het stroomcircuit waarop de subwoofer is aangesloten. Raadpleeg uw dealer voor meer informatie.
Het aan/uit indicatielampje licht op, maar de subwoofer geeft geen geluid.	 Controleer de niveau-instelling in uw processor/versterker Ga na of de uitgangspluggen van de geluidsbron het juiste signaal voeren, op het juiste niveau stann en voldoende vermogen leveren om de subwoofer aan te drijven. Controleer alle aansluitingen tussen subwoofer en de geluidsbron en voer indien nodig correcties uit.
Ik hoor nog steeds geen geluid.	Raadpleeg uw dealer voor meer informatie.

FEJL	MIDDEL
Net indikatorer lyser ikke.	Check at stikket til subwoofere er sat i stikkontakten, og at der er tændt for den. Check alle sikringer og hovedstrømbrydere, som har indflydelse på strømmen til subwoofere. Kontakt forhandleren for yderligere detaljer.
Hvis net indikatorer lyser, men der ingen lyd kommer fra subwoofere	 Check og juster volumen gennem indstillingerne paa Deres forstaerker/receiver. Check at udgangsstikket på dit anlæg er korrekt monteret og justeret til passende niveau for at trække subwoofere. Check at alle forbindelser mellem subwoofere og dit anlæg er korrekt monteret og justeret, om nødvendigt.
Hvis der stadig ikke er nogen lyd.	Kontakt forhandleren for yderligere detaljer.

SPECIFICATIONS

(F) Spécifications (D) Technische Daten (I) Specifiche (ES) Especificaciones (P) Especificações (NL) Technische gegevens (DK) Specifikationer (CN)

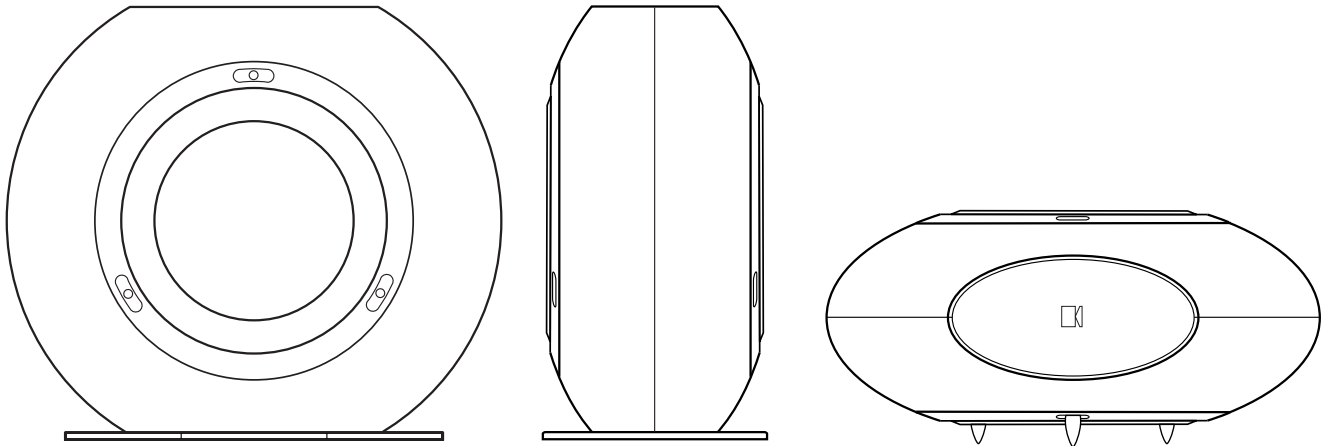

Model	HTB2
Type	Powered Subwoofer
LF Drive Unit	1 x 250mm (10in.) + 1 x 250mm (10in.) ABR
Frequency range	30Hz - 250Hz
Amplifier	250 Watts built in class D amplifier
Maximum Output (SPL)	110dB
Low Pass Filter	Fixed 250Hz, 4th-order
Low Level Signal Inputs	RCA phono socket
Enclosure Type	Passive radiator
Internal Volume	15 litres
Net Weight	11kg (24.2lbs)
Dimensions (H x W x D)	390 x 440 x 195 mm (vertical); 227 x 440 x 385 mm (horizontal). 15.3 x 17.3 x 7.6 in. (vertical); 8.9 x 17.3 x 15.1 in. (horizontal).
Power Requirements	100 - 240V ac ~, 50 - 60Hz
Finish	High Gloss Black or High Gloss Silver

GP Acoustics reserve the right, in line with continuous research and development, to amend or change specifications without prior notice. E. & O.E.

GP Acoustics (UK) Ltd, Eccleston Road, Tovil, Maidstone, Kent, ME15 6QP U.K.
Telephone: + 44 (0)1622 672261 Fax: + 44 (0)1622 750653

www.kef.com

KEF America, Inc. 10 Timber Lane, Marlboro, New Jersey 07746 U.S.A
Telephone: +(1) 732 683 2356 Fax: +(1) 732 683 2358

www.kef.com

GP Acoustics GmbH, Heinrichstraße 51, D-44536 Lünen, Deutschland.
Telephone: +49 (0) 231 9860-320. Fax: +49 (0) 231 9860-330

www.kefaudio.de

GP Acoustics (France) SAS, 39 Rue des Granges Galand - BP414, 37554 Saint Avertin CEDEX, France
Tel : +33(0)2 47 80 49 01 Fax : +33(0)2 47 27 89 64

www.kef.com/France/

KEF®