

S2 FM MODE S1-A S1-B S1-C MPX FILTER # BAND SELECTOR

AUTO/MUTING MONO

OFF WIDE FM ON NARROW AM

TUNER (X05-16)

(IF AMP1)

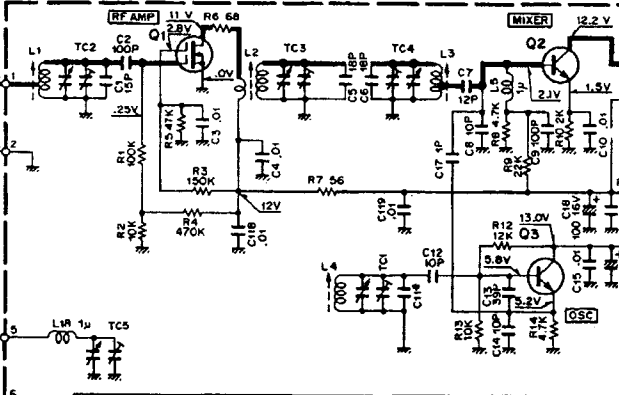
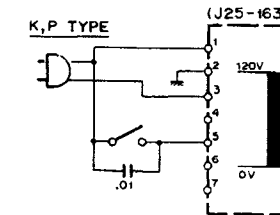
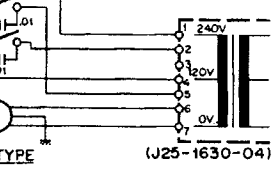
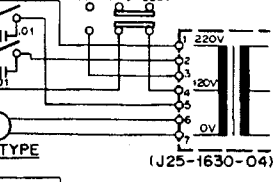
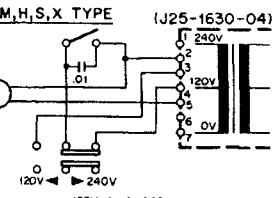
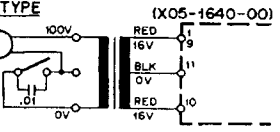
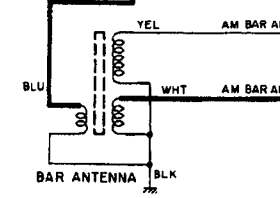
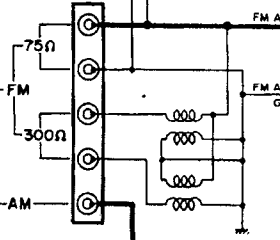
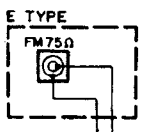

MIXER

12.2 V

OSC

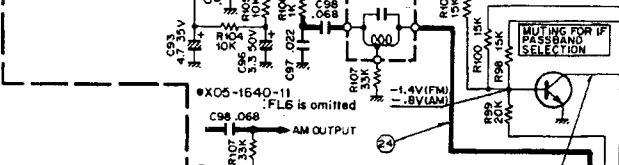
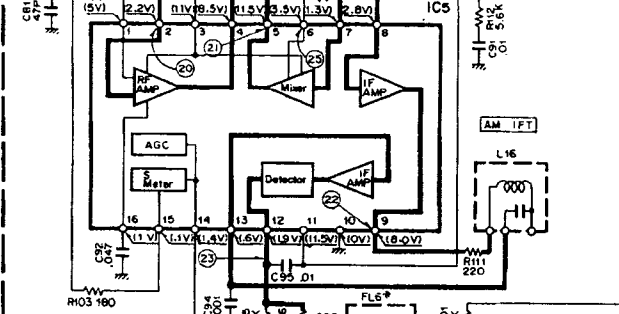
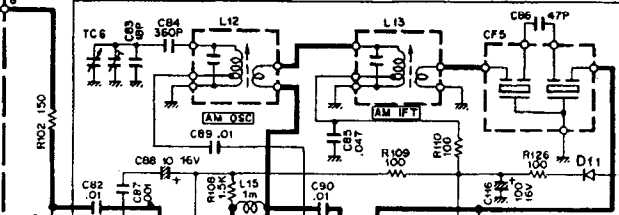

*X05-1640-11 FL6 is omitted

FL6 is omitted

AM OUTPUT

AM OUTPUT

AM OUTPUT

AM OUTPUT

AM OUTPUT

AM OUTPUT

AM OUTPUT

AM OUTPUT

AM OUTPUT

AM OUTPUT

AM OUTPUT

AM OUTPUT

AM OUTPUT

REGIONAL CIRCUIT MODIFICATION (X05-1640-00)

Q-11	2-71	0-81	0-41
C11	22P	22P	12P
C68,69	2700P	1200P	4700P/1200P
C65,67			2700P
R57,60	18K	27K	18K 27K
R56,59	3K	4.3K	3K 4.3K

VOLTAGE REGULATOR

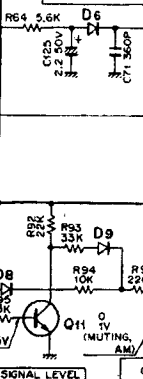
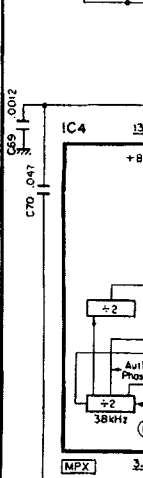
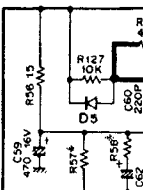
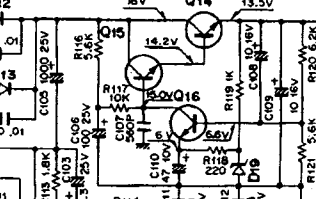

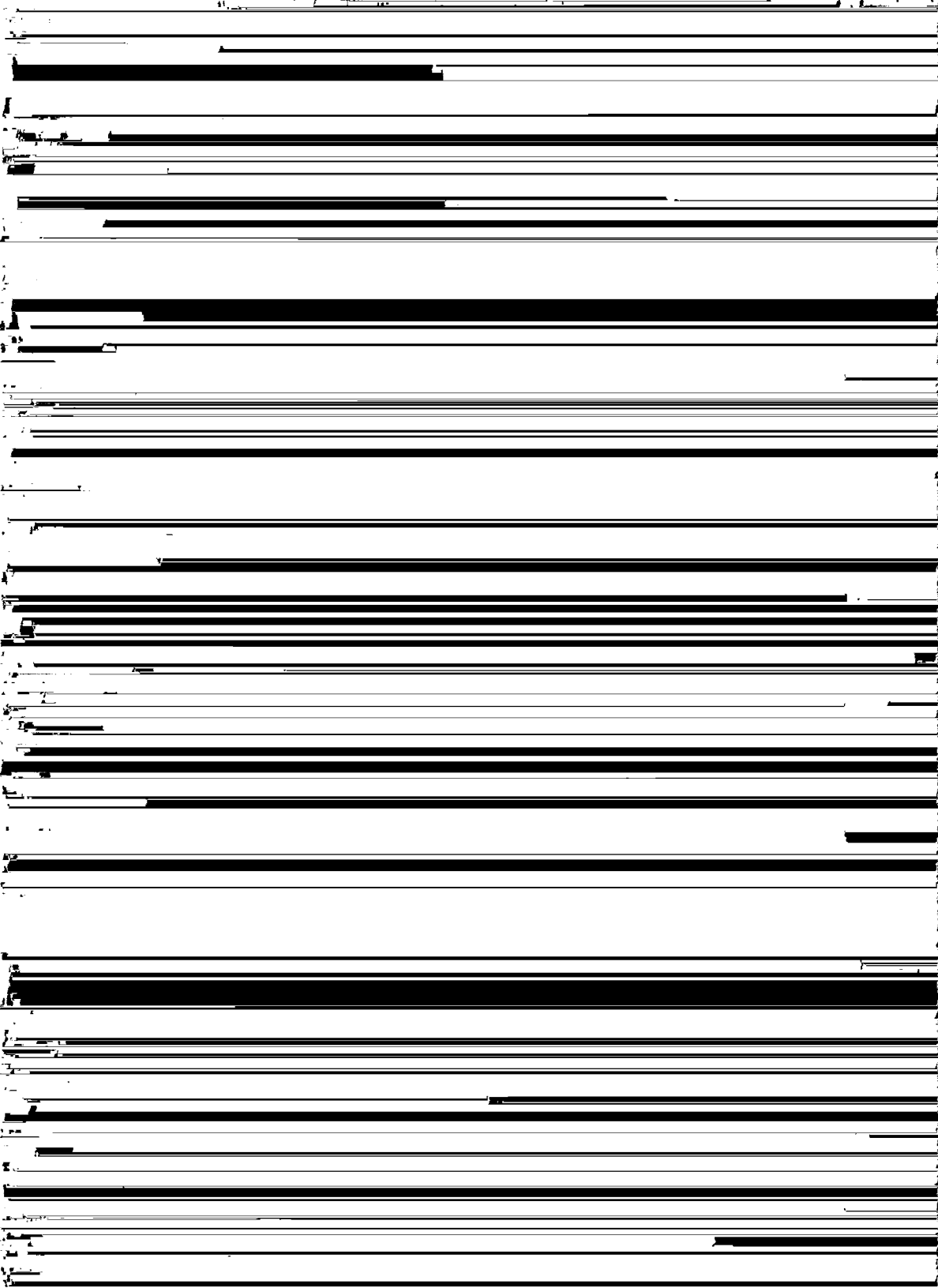

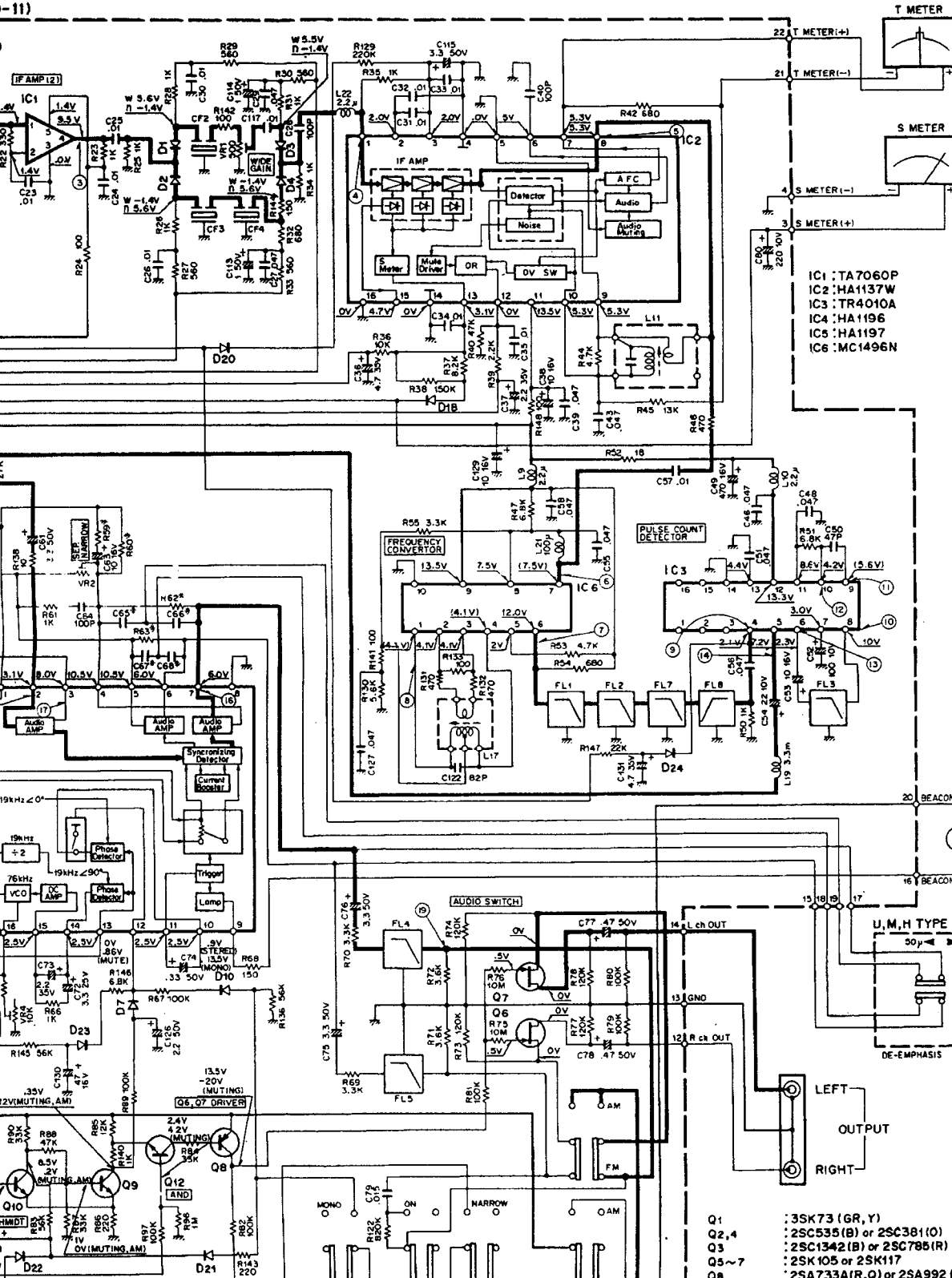

IC1 : TA7060P
 IC2 : HA1137W
 IC3 : TR4010A
 IC4 : HA1196
 IC5 : HA1197
 IC6 : MC1496N

Q1 : 3SK73 (GR, Y)
 Q2,4 : 2SC535(B) or 2SC381(O)
 Q3 : 2SC1342(B) or 2SC785(R)
 Q5~7 : 2SK105 or 2SK117
 Q8 : 2SA733A(IR, O) or 2SA994