



Klipsch[®]
REFERENCE
PREMIERE

HD WIRELESS

EXTENDED USER GUIDE

FUTURE PROOF YOUR SYSTEM

FREE FIRMWARE UPGRADES FOR LIFE

VISIT **KLIPSCH.COM/RP-HD-WIRELESS** TO REGISTER YOUR HD CONTROL CENTER AND GET ACCESS TO NEW FEATURES AND FIRMWARE UPDATES AS THEY BECOME AVAILABLE.

HD CONTROL CENTER (RP-HUB1)

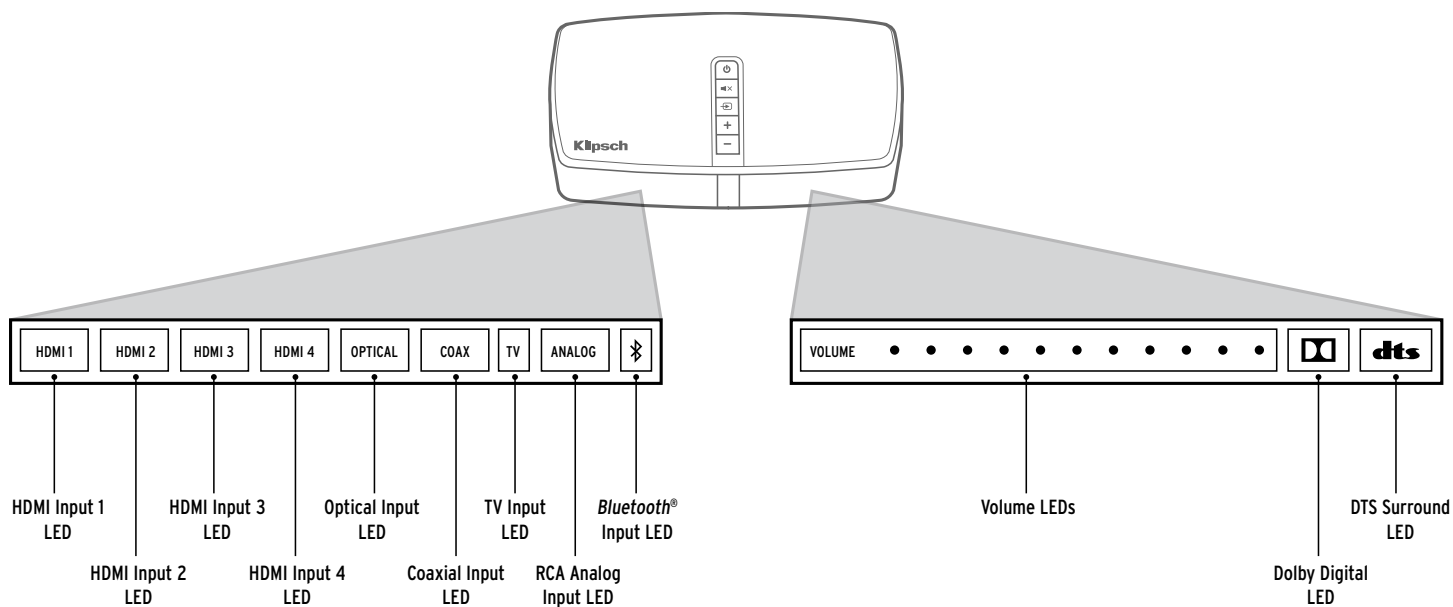
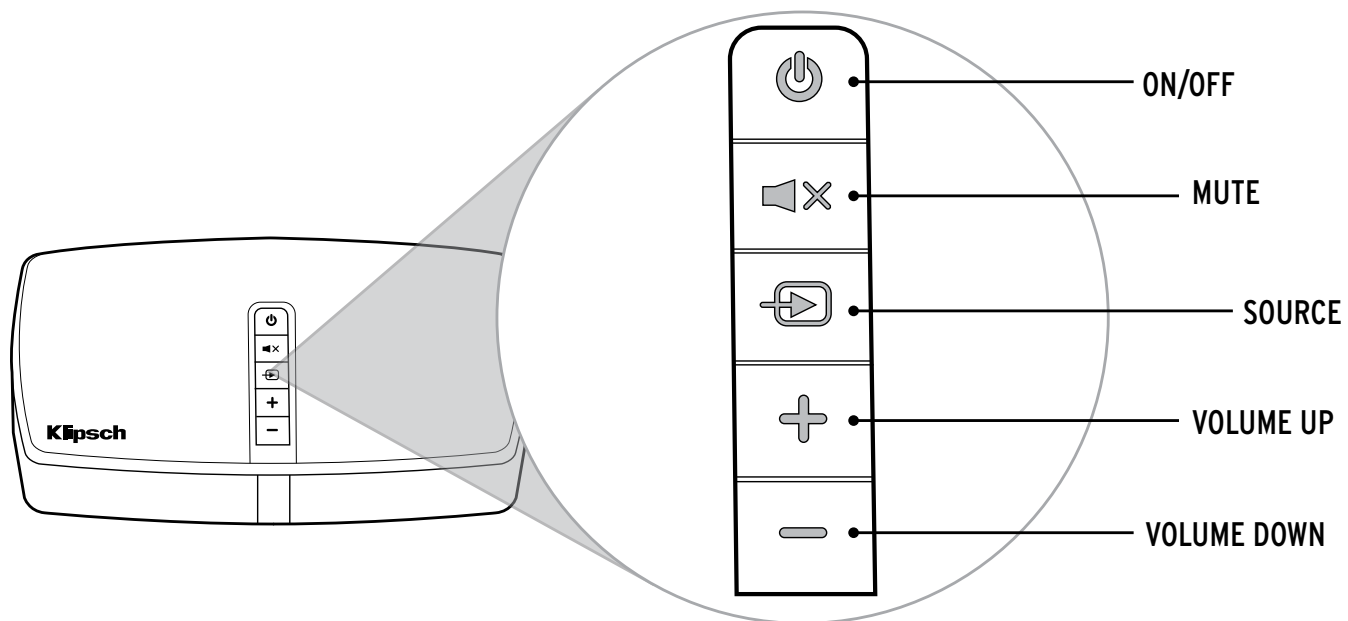

HD CONTROL CENTER (RP-HUB1)

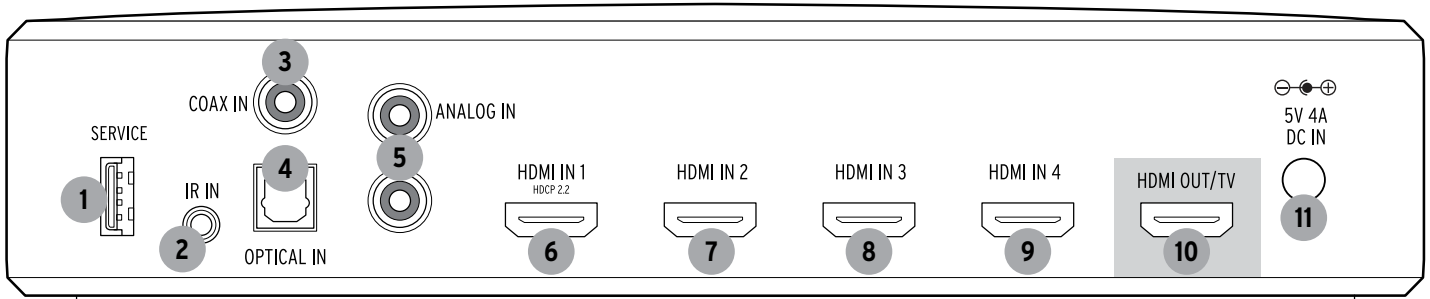

1 Service Port	2 3.5mm IR Input	3 Coaxial Input	4 Optical Input	5 RCA Analog Inputs	
6 HDMI Input 1 (HDMI 2.0 and HDCP 2.2 Compliant)	7 HDMI Input 2	8 HDMI Input 3	9 HDMI Input 4	10 HDMI OUT / TV	11 Power Input DC 5V

FIRMWARE UPDATES

- Firmware updates need to be downloaded from **KLIPSCH.COM** to a USB storage device and then inserted into the HD Control Center's **SERVICE PORT**.
- Upon plugging in a USB storage device which contains a new firmware file, a confirmation will pop up to remind you none of your settings will be affected.
- Select **YES** to begin the update process. Wait until the on-screen display comes back and the HD Control Center's Volume LEDs return to normal operation.

NOTE: This update also applies if old speaker firmware is detected upon startup when new versions are available.

REMOTE

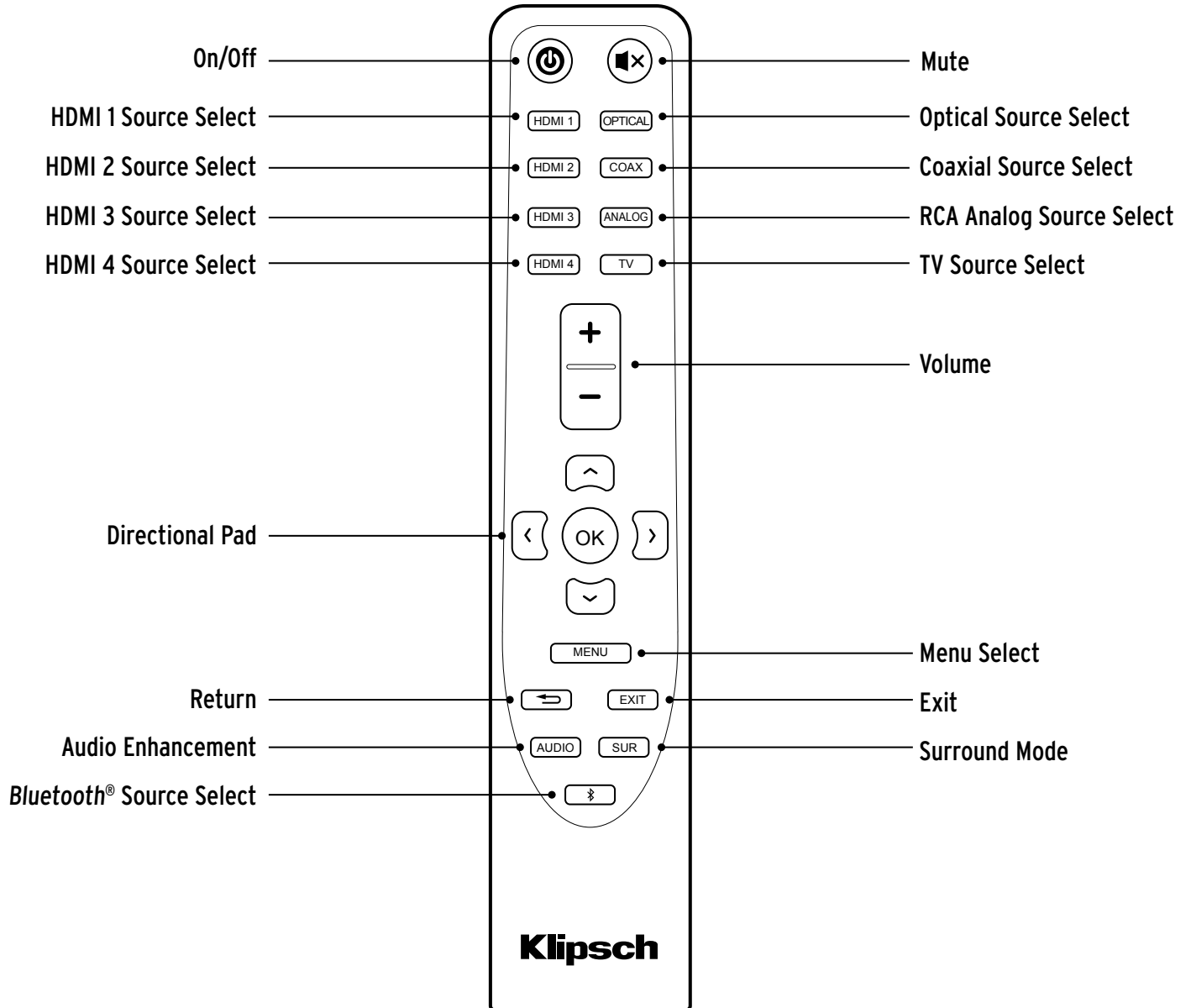

QUICK SETUP

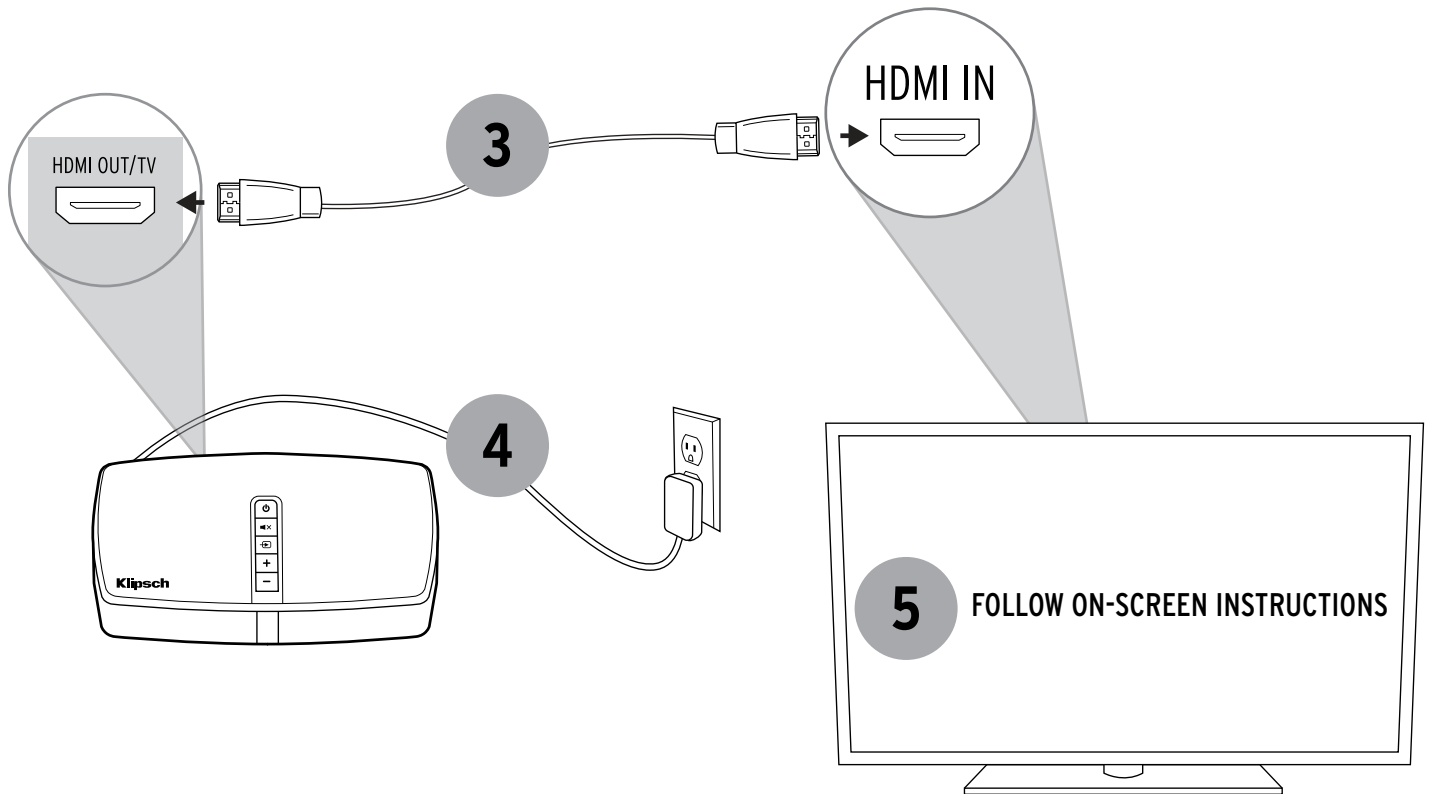
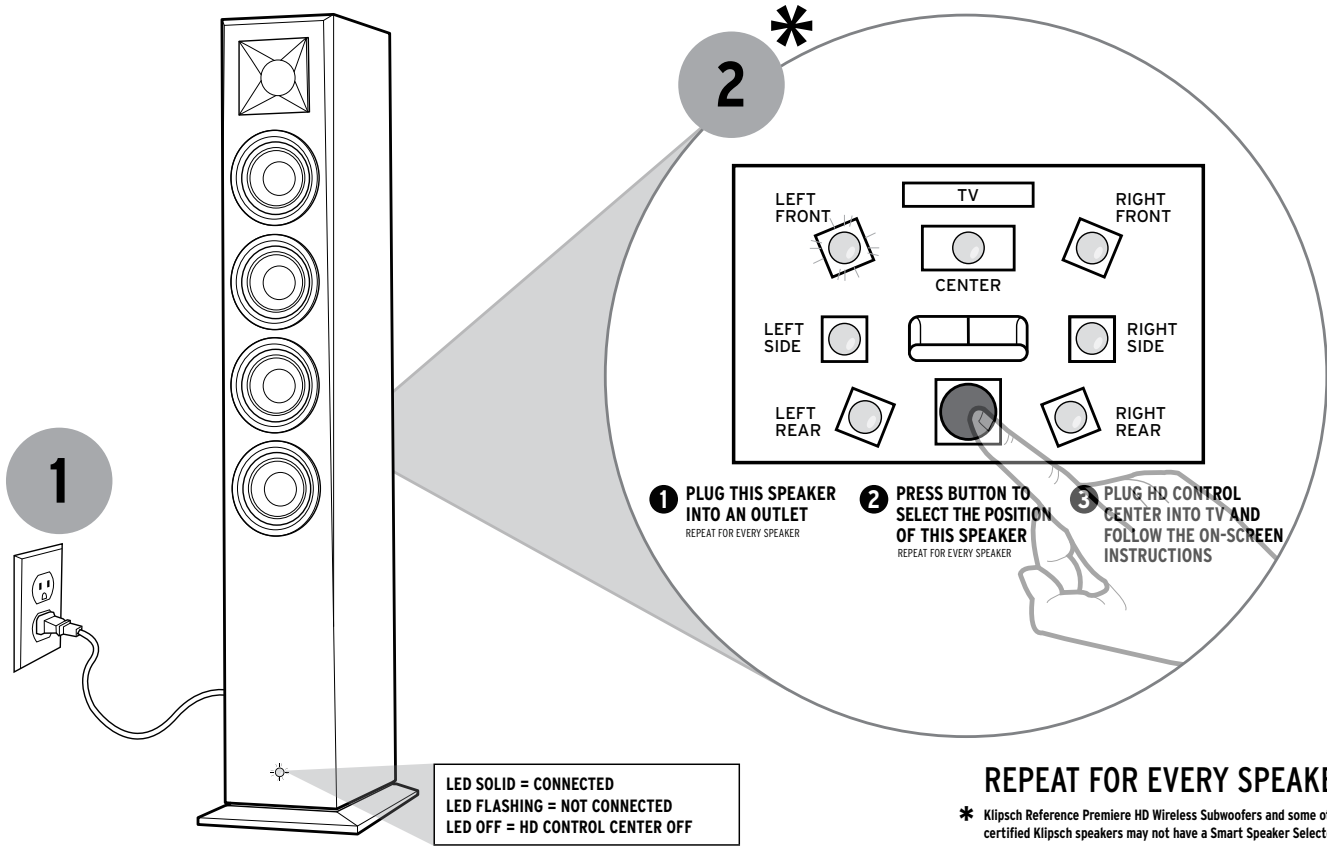

ON-SCREEN SETUP GUIDE

LANGUAGE SELECTION

- Select your desired language.

NOTE: You will have the ability to change your language preference at any time from the menu system.

ADD SPEAKERS

- Plug in your HD Wireless speakers if you haven't already. The LEDs on the front of the speakers will blink when they are ready to be discovered.
- Your HD Control Center will then begin searching for your speakers that will comprise your system. This process should take about 1 - 2 minutes. At the end, a notification will appear indicating the number of speakers that were found. If no speakers were discovered, please try the setup again.

CONFIRM SPEAKER LOCATIONS

- Once your speakers have been discovered, their channel assignments within the system must be confirmed. One by one, each speaker will play a test tone and flash its front-facing LED to denote which is currently active. You will be asked where the tone is coming from and select from the list of speakers on screen. The default selection should be the one corresponding to the one you selected on the Smart Speaker Selector on the speaker's rear panel.
- If you selected a different location than the default, your HD Control Center will reassign the speaker location and update the speaker.

NOTE: If conflicts occur, you will be prompted with a warning that multiple speakers are assigned to the same location. Choose whether to check the speaker locations again or continue with the redundancy.

SETUP COMPLETE

- Your basic setup process is complete. You are now ready to enjoy your system.

ADJUST SPEAKER LEVELS

- Customize the relative level of each individual speaker.
- Press **UP OR DOWN** on your remote to change the **SELECTED SPEAKER**.
- Press **RIGHT OR LEFT** to increase or decrease the selected speaker's **LEVEL**.
- When you're happy with your adjustments, select **DONE** at the bottom of the menu.

NOTE: If multiple speakers are assigned to a given channel, they should have independent entries in the speaker list. You should be alerted, however, that movie performance will be weak if there is such an overlap in assignment.

ADJUST SPEAKER DISTANCES

- Pinpoint the distance of each speaker in your system from your primary listening position.
- Press **UP OR DOWN** on your remote to change the **SELECTED SPEAKER**.
- Press **RIGHT OR LEFT** to increase or decrease the selected speaker's **DISTANCE**.
- When you're happy with your adjustments, select **DONE** at the bottom of the menu.

NOTE: You can toggle between feet and meters as units of measure for your adjustments.

SUBWOOFER POSITION

- This applies an EQ based on the placement of your subwoofer in order to optimize performance. Choose between these three options:

WALL

CORNER

OTHER

LOW-VOLUME BASS BOOST

- Low-Volume Bass Boost is a custom EQ based on psychoacoustic principles. This dynamic feature aims to add richness when sound levels are low.

AUDIO ENHANCEMENT

- Audio Enhancement offers selected equalization settings to improve your listening experience. Choose between these three options:

NATURAL

No enhancements applied. Default option upon startup.

DIALOGUE

Increases dialogue EQ for enhanced vocal clarity without increasing ambient sound.

NIGHT MODE

Adjusts dynamic range for quieter listening environments.

SURROUND MODES

- The surround modes can be used to adjust the sound field per your preferences. In almost all situations, **DIRECT** is the preferred surround mode. This setting will play back the audio content in its native format and number of channels. All surround modes will automatically configure themselves based on the number of speakers in your system. No additional user setup is necessary to use these modes.

DIRECT

All content is decoded and played back in its native format. **This is the best setting for most situations.**

STEREO

Takes any input material and plays it through left and right speakers only. If the source is not stereo, a stereo mix will be derived from the input.

ALL-CHANNEL STEREO

Plays a stereo signal through all speakers in the system. This mode will downmix any surround information to stereo before routing to the speakers.

DOLBY PLIIX MOVIE

Dolby Pro-Logic IIx processing is applied to the incoming source with the decoder configured for movies.

DOLBY PLIIX MUSIC

Dolby Pro-Logic IIx processing is applied to the incoming source with the decoder configured for music.

DOLBY PLIIX GAME

Dolby Pro-Logic IIx processing is applied to the incoming source with the decoder configured for gaming content.

DOLBY EX

Dolby EX processing is applied to the incoming source to create virtual rear channel information. Only valid for systems with rear speakers present.

DTS NEO:6 CINEMA

DTS NEO:6 processing is applied to the incoming source with the decoder configured for movies.

DTS NEO:6 MUSIC

DTS NEO:6 processing is applied to the incoming source with the decoder configured for music.

NOTE: The Dolby Pro-Logic IIx and DTS Neo:6 modes can also be used to create channels for speakers that may not be used by the native audio format.

LIP SYNC DELAY

- Your system is able to compensate for synchronization issues between audio and video by allowing for an adjustable audio delay.
- You can adjust this delay by pressing the **LEFT AND RIGHT** buttons on your remote.

SYSTEM STATUS

• System Status shows general information regarding your current setup:

- **INPUT SOURCE**
- **SIGNAL TYPE**
- **WISA SAMPLE RATE**
- **SPEAKER MAP**
- **SURROUND MODE**
- **BLUETOOTH® STATUS**

SPEAKER STATUS

• Speaker Status shows how your speakers are currently configured, one at a time. Pressing the **LEFT OR RIGHT** buttons on the remote allows you to go through all of your speakers that are currently part of your system. Displayed information includes:

- **CHANNEL**
- **NAME**
- **CROSSOVER**
- **MCU FIRMWARE**
- **RX FIRMWARE**
- **AMPLIFIER**
- **MAC ADDRESS**

NOTE: If one of your speakers is out of date, an option to update the firmware will be provided.

HD CONTROL CENTER FIRMWARE

• This shows any information related to versions of firmware for various componentry:

- **HOST FIRMWARE**
- **MCU FIRMWARE**
- **DSP FIRMWARE**
- **TX FIRMWARE**
- **HDMI FIRMWARE**

LANGUAGES

- You can change the language of all the text displayed on-screen. Press the left or right buttons on your remote to switch between languages when the menu item is selected. You can choose between these supported languages:

- **ENGLISH**
- **SPANISH**
- **FRENCH**

APPEARANCE

MENU TIMEOUT

Menu Timeout refers to the length of time after which the on-screen display will disappear after inactivity.

HD CONTROL CENTER DISPLAY

Adjusts the brightness of HD Control Center's illuminated face. Use the directional buttons to switch between **BRIGHT**, **DIM** and **OFF** options.

SPEAKER LEDs

The LEDs on the front of the speaker will always be fully lit when it is selected in a menu, its settings are being changed, or the system is being set up or otherwise transitioning. You can change the default state of the LEDs for normal operation between **BRIGHT**, **DIM** and **OFF**.

ARC

- Audio Return Channel (ARC) enables audio to be sent from a TV via HDMI. When this setting is selected, you can toggle ARC **ON OR OFF** by pressing the **LEFT OR RIGHT** buttons on the remote.

CEC

- Consumer Electronics Control (CEC) allows for shared remote control functionality over HDMI. When this setting is selected, you can toggle CEC **ON OR OFF** by pressing the **LEFT OR RIGHT** buttons on the remote.

POWER SAVE MODE

- The HD Control Center will automatically revert to standby mode after half an hour of inactivity in order to conserve energy. However, you can disable this feature if so desired.

HDMI STANDBY PASS-THROUGH

- The HD Control Center has the ability to pass through video and audio from the last active HDMI input while in standby mode. This feature is disabled by default.

ADVANCED SPEAKER ACTIONS

- Advanced Speaker Actions allows for thorough control of a system's speakers. You can:
 - **IDENTIFY SPEAKERS**
 - **MOVE SPEAKERS**
 - **ADD SPEAKERS**
 - **REMOVE SPEAKERS**
- If you select **IDENTIFY SPEAKERS**, **MOVE SPEAKERS** or **REMOVE SPEAKERS**, you will be asked which speaker you would like to perform the action on. Each speaker will be listed by name and MAC address when highlighted.

FACTORY RESET

- Factory Reset returns all settings of the system to factory defaults. Upon completing Factory Reset, the on-screen display will direct you to the setup guide to start your configurations from the beginning.

BLUETOOTH® WIRELESS TECHNOLOGY

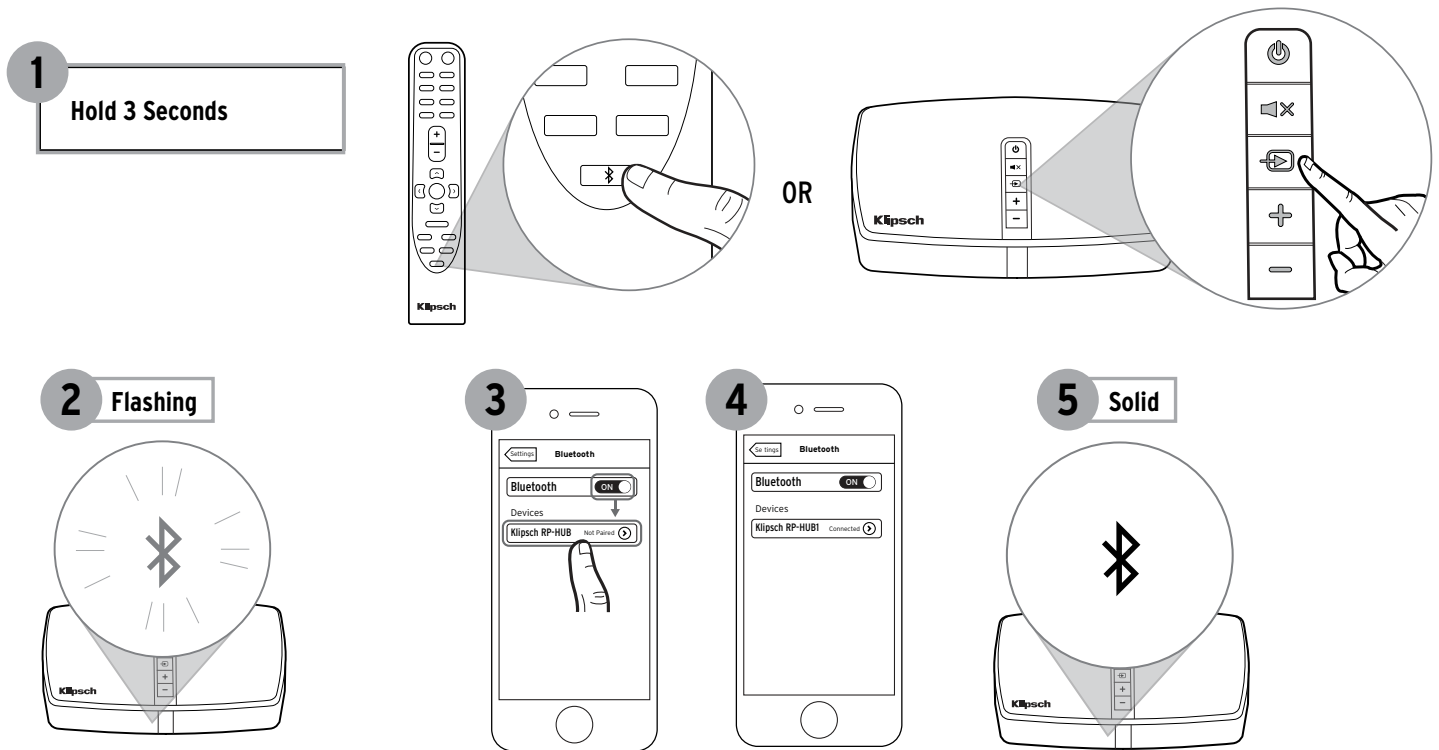

Example only. Your device may differ.

CARE AND CLEANING

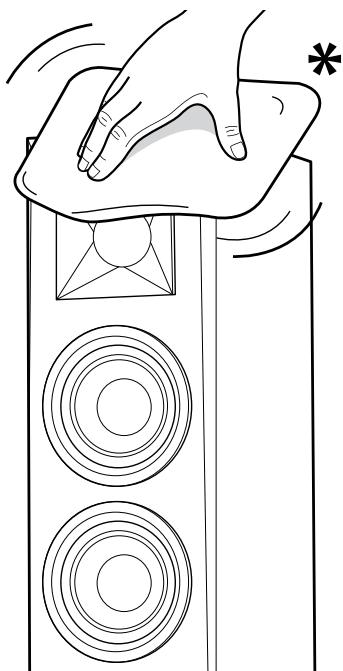

* USE MICROFIBER CLOTHS ONLY

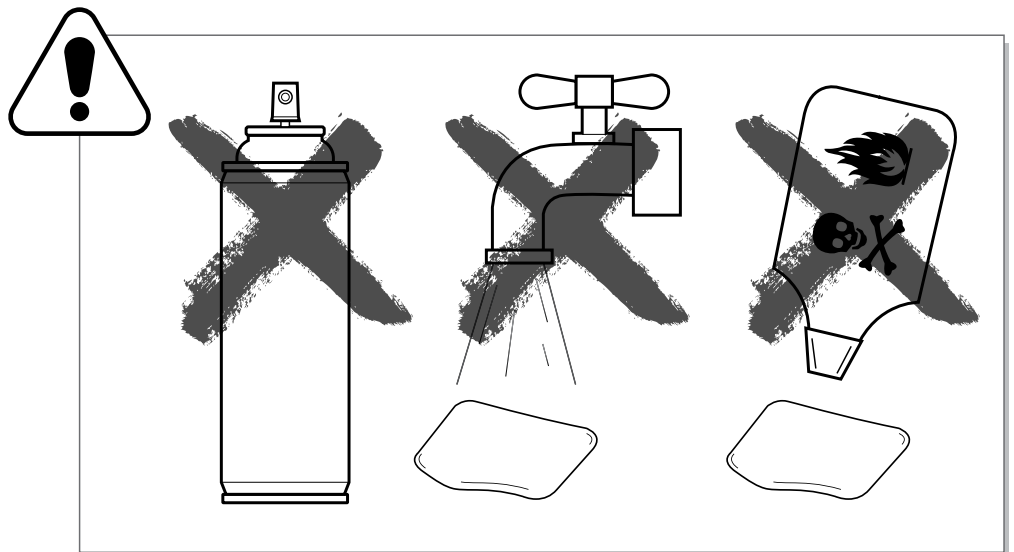

ENGLISH - WARRANTY - U.S.

Klipsch Group, Inc. (KGI) warrants to the original retail purchaser that this product is to be free from defective materials and workmanship for a period of one (1) year on electronics and three (3) years on woofer, cabinet and non-electrical mechanics, from the date of purchase, if it is properly used and maintained. If this product proves defective in either material or workmanship, KGI, at its option, will (a) repair the product, or (b) replace the product, at no charge for parts or labor. If the product model is no longer available and cannot be repaired effectively or replaced with an identical model, KGI at its sole option may replace the unit with a current model of equal or greater value. In some cases, modification to the mounting surface may be required where a new model is substituted. KGI assumes no responsibility or liability for such modification. To obtain a repair or replacement under the terms of this warranty, please return to dealer first, if possible, and the dealer will direct you accordingly for repairs or replacement. You will be required to submit a copy of the original receipt.

Return shipping for exchanges/repairs is the sole responsibility of the original retail purchaser.

Limitations:

- This limited warranty does not cover failure of the product resulting from improper installation, misuse, abuse, accident, neglect, mishandling, or wear from ordinary use or environmental deterioration.
- This limited warranty does not cover cosmetic damage, including paint damage, or consequential damage to other components or premises which may result for any reason from the failure of the product.
- This limited warranty is null and void for products not used in accordance with KGI's instructions.
- This limited warranty is null and void for products with altered or missing serial numbers and for products not purchased from an authorized dealer.
- This limited warranty terminates if you sell or otherwise transfer this product to another party.

THIS WARRANTY GIVES YOU SPECIFIC LEGAL RIGHTS, AND YOU MAY ALSO HAVE OTHER RIGHTS WHICH VARY FROM STATE TO STATE, JURISDICTION TO JURISDICTION OR COUNTRY TO COUNTRY. KGI'S RESPONSIBILITY FOR MALFUNCTIONS AND DEFECTS IN HARDWARE IS LIMITED TO REPLACEMENT OR REPAIR AS SET FORTH IN THIS WARRANTY STATEMENT. ALL EXPRESS AND IMPLIED WARRANTIES FOR THE PRODUCT, INCLUDING BUT NOT LIMITED TO ANY IMPLIED WARRANTIES OF MERCHANTABILITY AND FITNESS FOR A PARTICULAR PURPOSE, ARE LIMITED IN TIME TO THE TERM OF THIS WARRANTY. SOME STATES, JURISDICTIONS OR COUNTRIES DO NOT ALLOW THE EXCLUSION OF CERTAIN IMPLIED WARRANTIES OR CONDITIONS, OR LIMITATIONS ON HOW LONG AN IMPLIED WARRANTY OR CONDITION LASTS, SO THIS LIMITATION MAY NOT APPLY TO YOU. KGI DOES NOT ACCEPT LIABILITY FOR SPECIAL, INDIRECT, CONSEQUENTIAL OR INCIDENTAL DAMAGES, INCLUDING WITHOUT LIMITATION, ANY LIABILITY FOR THIRD PARTY CLAIMS AGAINST YOU FOR DAMAGES OR FOR PRODUCTS NOT BEING AVAILABLE FOR USE. THE MAXIMUM LIABILITY FOR WHICH KGI MAY BE RESPONSIBLE WILL BE NO MORE THAN THE AMOUNT YOU PAID FOR THE PRODUCT THAT IS THE SUBJECT OF THE CLAIM. SOME STATES, JURISDICTIONS OR COUNTRIES DO NOT ALLOW THE EXCLUSION OR LIMITATION OF SPECIAL, INDIRECT, INCIDENTAL OR CONSEQUENTIAL DAMAGES, SO THE ABOVE LIMITATION OR EXCLUSION MAY NOT APPLY TO YOU.

WARRANTY OUTSIDE THE U.S.

The Warranty on this product shall comply with applicable law when sold to a consumer outside of the United States. To obtain any applicable warranty service, please contact the dealer from which you purchased this product, or the distributor that supplied this product.

INDEX

Add Speakers	7	Identify Speakers.....	13
Adjust Sound	8-10	Input Source	11
Adjust Speaker Levels	8	Language.....	7, 12
Adjust Speaker Distances.....	8	Lip Sync Delay.....	10
Advanced.....	13	Low-Volume Bass Boost	9
Advanced Speaker Actions	13	MAC Address.....	11
All-Channel Stereo.....	10	MCU Firmware	11
Amplifier	11	Menu Timeout	12
Appearance.....	12	Move Speakers.....	13
ARC.....	12	Name.....	11
Audio Enhancement	9	Natural	9
Natural	9	Night Mode.....	9
Dialogue.....	9	On-Screen Setup Guide	7
Night Mode.....	9	Power Save Mode.....	13
Bluetooth® Status	11	Quick Setup.....	6
Bluetooth® Wireless Technology.....	14	Remote.....	5
Care and Cleaning.....	14	Remove Speakers	13
CEC	12	RX Firmware	11
Channel.....	11	Setup Guide	7
Confirm Speaker Locations.....	7	Signal Type.....	11
Crossover	11	Status	11
Dialogue.....	9	Speaker LEDs.....	12
Direct.....	10	Speaker Map.....	11
Dolby PLIIx Movie	10	Speaker Status	11
Dolby PLIIx Music	10	Stereo.....	10
Dolby PLIIx Game	10	Subwoofer Position	8
Dolby EX.....	10	Surround Mode	10, 11
DSP Firmware	11	System Status	11
DTS Neo:6 Cinema.....	10	TX Firmware.....	11
DTS Neo:5 Music	10	Warranty	15
Factory Reset	13	WiSA Sample Rate	11
Firmware Updates.....	4		
HD Control Center	3		
HD Control Center Display.....	12		
HD Control Center Firmware.....	11		
HDMI Firmware.....	11		
HDMI Standby Pass-Through.....	13		
Host Firmware.....	11		

THIS DOCUMENT CONTAINS INFORMATION THAT IS SUBJECT TO CHANGE WITHOUT NOTICE.

©2016 KLIPSCH GROUP, INC. KLIPSCH IS A REGISTERED TRADEMARK OF KLIPSCH, GROUP INC. A WHOLLY OWNED SUBSIDIARY OF VOXX INTERNATIONAL CORPORATION.

THE *BLUETOOTH*[®] WORD MARK AND LOGOS ARE REGISTERED TRADEMARKS OWNED BY BLUETOOTH SIG, INC. AND ANY USE OF SUCH MARKS BY KLIPSCH GROUP, INC. IS UNDER LICENSE.

THE APTX[™] SOFTWARE IS COPYRIGHT CSR PLC OR ITS GROUP COMPANIES. ALL RIGHTS RESERVED. THE APTX[®] MARK IS A REGISTERED TRADEMARK OF CSR PLC OR ONE OF ITS COMPANIES AND MAY BE REGISTERED IN ONE OR MORE JURISDICTIONS.

THE TERMS HDMI AND HDMI HIGH-DEFINITION MULTIMEDIA INTERFACE, AND THE HDMI LOGO ARE TRADEMARKS OR REGISTERED TRADEMARKS OF HDMI LICENSING LLC IN THE UNITED STATES AND OTHER COUNTRIES.

DOLBY, PRO LOGIC, AND THE DOUBLE-D SYMBOL ARE REGISTERED ARE REGISTERED TRADEMARKS OF DOLBY LABORATORIES.

FOR DTS PATENTS, SEE [HTTP://PATENTS.DTS.COM](http://patents.dts.com). MANUFACTURED UNDER LICENSE FROM DTS LICENSING LIMITED. DTS, THE SYMBOL, & DTS AND THE SYMBOL TOGETHER ARE REGISTERED TRADEMARKS, AND DTS DIGITAL SURROUND IS A TRADEMARK OF DTS, INC. © DTS, INC. ALL RIGHTS RESERVED

