

Owner's Manual

N°326S
Preamplifier

Important Safety Instructions

1. Read these instructions
2. Keep these instructions.
3. Heed all warnings.
4. Follow all instructions.
5. Do not use this apparatus near water.
6. Clean only with a dry cloth.
7. Do not block ventilation openings. Install in accordance with the manufacturer's instructions.
8. Do not install near any heat sources such as radiators, heat registers, stoves, or another apparatus that produces heat.
9. Do not defeat the safety purpose of the polarized or grounding-type plug. A polarized plug has two blades with one wider than the other. A grounding-type plug has two blades and a third grounding prong. The wide blade or third prong is provided for safety. If the provided plug does not fit into the outlet, consult an electrician for replacement of the obsolete outlet.
10. Protect the power cord from being walked on or pinched, particularly at plugs, convenience receptacles, or the point where it exits from the apparatus.
11. Only use attachments and accessories specified by the manufacturer.
12.  Use only with the cart, stand, tripod, bracket, or table specified by the manufacturer or sold with the apparatus. When a cart is used, use caution when moving the cart/apparatus combination to avoid injury or tip over.
13. Unplug this apparatus during lightning storms or when unused for long periods of time.
14. Refer all servicing to qualified service personnel. Servicing is required when the apparatus has been damaged in any way, such as when the power cord or plug has been damaged; liquid has been spilled or objects have fallen into the apparatus; or the apparatus has been exposed to rain or moisture, does not operate normally, or has been dropped.
15. No naked flame sources, such as candles, should be placed on the apparatus.
16. The power cord is intended to be the safety disconnect device for this apparatus. Ready access to the power cord should be maintained at all times.
17. Terminals marked with this symbol may be considered HAZARDOUS LIVE and the external wiring connected to these terminals requires installation by an INSTRUCTED PERSON or the use of ready-made leads or cords.

Warning!

To reduce the risk of fire or electric shock, do not expose the apparatus to rain or moisture. Do not place objects containing liquid, such as vases, on this apparatus.

FCC Notice

This equipment has been tested and found to comply with the limits for a Class B digital device, pursuant to part 15 of the FCC Rules. These limits are designed to provide reasonable protection against harmful interference in a residential installation. This equipment generates, uses, and can radiate radio frequency energy and, if not installed and used in accordance with the instructions, may cause harmful interference to radio communications. However, there is no guarantee that interference will not occur in a particular installation. If this equipment does cause harmful interference to radio or television reception, which can be determined by turning the equipment off and on, the user is encouraged to try to correct the interference by one or more of the following measures:

- Reorient or relocate the receiving antenna.
- Increase the separation between the equipment and the receiver.
- Connect the equipment into an outlet on a circuit different from that to which the receiver is connected.
- Consult an authorized Mark Levinson dealer or an experienced radio/TV technician for help.

Caution!

Changes or modifications not expressly approved by the party responsible for compliance could void the user's authority to operate the equipment.

Canada

This Class B digital apparatus complies with Canadian ICES-003.

Cet appareil numérique de la classe B est conforme à la norme NMB-003 du Canada.



3 Oak Park
Bedford, MA 01730-1413 USA
Telephone: 781-280-0300
Fax: 781-280-0490
www.marklevinson.com

Customer Service

Telephone: 781-280-0300
Sales Fax: 781-280-0495
Service Fax: 781-280-0499

Product Shipments

16 Progress Road
Billerica, MA 01821-5730 USA

Part No. 070-16658 | Rev 0 | 06/04

“Mark Levinson” and the Mark Levinson logo are registered trademarks of Harman International Industries. U.S. patent numbers and other worldwide patents issued and pending.

“Madrigal Audio Laboratories” and the Madrigal Audio Laboratories logo are registered trademarks of Harman International Industries. U.S. patent numbers and other worldwide patents issued and pending.

©2004 Harman Specialty Group. All rights reserved.

This document should not be construed as a commitment on the part of Harman Specialty Group. The information it contains is subject to change without notice. Harman Specialty Group assumes no responsibility for errors that may appear within this document.

Table of Contents

Documentation Conventionsvii

Section 1: Getting Started

Special Design Features1-1
 Highlights ▪ Product Registration

Installation Considerations1-4
 Unpacking ▪ Placement ▪ Remote Control Batteries

Power Requirements1-7
 Warm-Up & Break-In Period ▪ Continuous Operation

Quick Start Guide1-8

Section 2: Basic Operation

Front Panel Overview2-1

Rear Panel Overview2-5

Linking2-9
 Making Link Connections ▪ Constructing Link
 Communication Cables ▪ Creating a Slave Chain ▪ Link
 Controls

Remote Control Overview2-15
 Operation Considerations ▪ Command Overview

v

Section 3: Setup Menu

Navigating the Setup Menu3-1
 setup button ▪ enter button ▪ select knob & ± buttons ▪
 volume knob & ± buttons

Set Inputs Menu3-3
 Set Inputs Menu Shortcut ▪ Name ▪ Gain ▪ Offset ▪
 Rec.Out

Teach IR Menu3-8

Setup Menu Parameters3-11
 Mute ▪ MaxVol ▪ Trig. ▪ Sw

Section 4: Controls & Modes

Standby 4-1
 SLEEP

Display Intensity 4-2

Polarity 4-3

Balance 4-3

Mono Playback 4-5
 MODE ▪ L + R Balance Control Tip ▪ L – R Phono
 Alignment Tip

SSP (Surround Sound Processor) Mode 4-8

Section 5: Troubleshooting & Maintenance

Troubleshooting 5-1
 No Power ▪ No Remote Control Operation ▪ No IR
 Learning ▪ No Main Output ▪ No Record Output ▪ Audible
 Hum ▪ “Missing” Input ▪ No Link Controls ▪ Erratic
 Behavior ▪ If All Else Fails...

Restoring Factory-Default Settings 5-4

Care & Maintenance 5-5

Appendix

Specifications A-1
 Dimensions

Installation Worksheet A-4

Declaraton of Conformity A-5

Index

Documentation Conventions

This document contains general safety, installation, and operation instructions for the N°326S Preamplifier. It is important to read this document before attempting to use this product. Pay particular attention to safety instructions.



Appears on the component to indicate the presence of uninsulated, dangerous voltages inside the enclosure – voltages that may be sufficient to constitute a risk of shock.



Appears on the component to indicate important operation and maintenance instructions included in the accompanying documentation.



Appears on the component to indicate compliance of with the EMC (Electromagnetic Compatibility) and LVD (Low-voltage Directive) standards of the European Community.

vii

WARNING

Calls attention to a procedure, practice, condition, or the like that, if not correctly performed or adhered to, could result in personal injuries or death.

CAUTION

Calls attention to a procedure, practice, condition, or the like that, if not correctly performed or adhered to, could result in damage or destruction to part or all of the component.

Note

Calls attention to information that is essential to highlight.

Special Design Features

Thank you for purchasing the N°326S Preamplifier. The N°326S features audio circuits, controls, architecture, and optional phono modules based on the critically acclaimed N°32. In fact, some audio circuits, such as the proprietary discrete volume attenuators, are identical to those found in the N°32. The N°326S is similar to the N°320S, but the main circuit board has been replaced with an Arlon® board that responds more quickly to transient signals in both the high and low frequency regions. The Arlon also presents a deeper imaging that reveals more of the subtle nuances of a recording, imparts a more engaging texture to the high frequencies, and presents more of the ambience of a recording. All of these properties work together to yield a sonic signature that is wider, deeper, warmer, and clearly superior.

With a single-chassis design, the N°326S achieves separation of audio circuit, control circuit, and power supply sections similar to that of the dual-chassis N°32. The internal structure of the N°326S separates these sections, while a steel shield box protects the power supply and other circuits against electrostatic and magnetic interference. Filtered AC power is routed outside audio circuit sections, providing audio circuits with the quiet, shielded environment essential for superior sound.

Like most high-performance audio components, the N°326S relies on clean, noise-free AC power to deliver maximum performance. Unfortunately, most AC power does not meet these standards. Common household appliances such as refrigerators, TVs, and computers often contaminate AC power lines with line noise, spikes, and other irregularities that make it difficult for audio circuits to perform up to their full potential.

To compensate for this, the N°326S offers a series of highly effective noise suppression and isolation techniques that begin filtering AC power for noise as soon as it enters the chassis. Audio and control circuit sections use independent power supplies, each with its own low-noise toroidal transformer. The audio circuit power transformer includes a Faraday shield between the AC power line and low-voltage secondaries for improved isolation.

In addition, the N°326S uses two active voltage regulation stages for audio circuit sections. A high-power stage absorbs line-voltage

and temperature variations, while a second high-performance stage provides local, high-speed, low-noise power for audio circuits.

An advanced dual-mono design allows the N°326S to achieve exceptional channel separation. Both audio channels use independent power supplies, communication circuits, and audio circuits. In fact, each channel's audio circuits are located in a separate area of the chassis. This innovative approach isolates each channel, allowing the N°326S to produce vividly detailed, three-dimensional sonic images.

To maximize channel separation, all left-channel connectors are located on one side of the rear panel and all right-channel connectors are located on the other side of the rear panel. The connector complement includes three balanced (female XLR) and four single-ended (Mark Levinson-designed RCA) stereo **input connectors** as well as separate stereo **main** and **record output** connectors. Two Link communication ports make it possible to link the N°326S to compatible Mark Levinson components, while a **trigger output** connector, **ir input** connector, and **RS-232** port offer even more control possibilities.

For even greater isolation, the N°326S deactivates **unused** inputs to prevent interference from other components. When an input is deactivated, the N°326S disconnects the input signal and ground connection, eliminating ground loop noise between the N°326S and the associated component. As a result, input signals pass through the N°326S with remarkable freedom from interference.

The N°326S offers seven configurable inputs, each of which is assigned to one of its balanced (XLR) or single-ended (RCA) **input connectors**. Single-ended input signals are converted to balanced signals upon entering the chassis, and processed as balanced signals thereafter. During this rigorous conversion process, meticulously balanced circuits preserve all input signal information, passing it to the associated power amplifier without the limitations of asymmetrical single-ended designs.

A large front panel **select knob** provides convenient selection of the desired input. When an input is selected, just press and hold the front panel or remote control **setup button** to open the corresponding **Set Inputs** menu, which can be used to change input names, optimize input gain levels, offset input volume levels, and assign **record output** connectors.

Two Mark Levinson-designed discrete volume attenuators control master volume level with unparalleled accuracy and sonic neutrality. Constructed from Arlon® circuit boards with local power supply regulation and bypass capacitors, the volume attenuators generate

optimal power and isolation for even the most sensitive adjustments. Precision surface-mounted resistors accommodate adjustments in 1.0dB increments up to 23.0dB and in 0.1dB increments above 23.0dB.

Unlike most stereo preamplifiers, the N°326S is designed to integrate with multi-channel surround sound processors without the complications associated with competing stereo and multi-channel master volume controls. **SSP (surround sound processor) mode** allows the N°326S to deactivate its master volume control to send line-level input signals to the associated processor. With no interference from the N°326S, the processor controls the relative volume level of all channels, allowing it to maintain its carefully calibrated levels.

Following the Mark Levinson tradition, the N°326S exceeds all reasonable expectations for a stereo preamplifier. Its flexible design – including seven configurable inputs, separate **main** and **record output** connectors, and complete surround sound processor integration – allow it to accommodate a wide range of demands. Even more, a series of advanced techniques shield audio circuits, resulting in an incomparable sound befitting sophisticated music reproduction systems.

Highlights

- 7 configurable inputs
- Maximum channel separation
- Advanced dual-mono design
- Multi-channel surround sound processor integration
- 3 balanced (female XLR) and 4 single-ended (Mark Levinson-designed RCA) **stereo input connectors**
- Separate **main** and **record output** connectors
- Independent power supplies, communication circuits, and audio circuits for each channel
- Effective noise suppression and isolation techniques
- AC power filtering
- 2 active voltage regulation stages for audio circuit sections
- Independent power supplies for audio circuit and control circuit sections, each with its own low-noise toroidal transformer
- Faraday shield between AC power line and low-voltage secondaries
- 2 proprietary discrete volume attenuators
- Deactivation of **unused** inputs to eliminate ground-loop noise

- Balanced conversion for single-ended input signals
- Mono or stereo playback
- Selectable output signal **polarity**
- **Balance** control
- Intuitive **Set Inputs** menu
- Sleep timer (standby)
- Large front panel display
- Selectable **display intensity**
- 2 Mark Levinson Link communication ports
- Configurable **trigger output** connector (12 or 5V)
- **ir input** connector
- **RS-232** port
- Optional phono modules

Product Registration

Please register the N°326S within 15 days of purchase. To do so, register online at www.marklevinson.com or complete and return the included product registration card. Retain the original, dated sales receipt as proof of warranty coverage.

1-4

Installation Considerations

The N°326S requires special care during installation to ensure optimal performance. Pay particular attention to the bulleted items that appear in this section and to other precautions that appear throughout this user guide.

Unpacking

- **DO** save all packing materials for possible future shipping needs.
- **DO** inspect the N°326S for signs of damage during shipment. If damage is discovered, contact an authorized Mark Levinson dealer for assistance making appropriate claims.
- **DO** locate and remove the accessory box from the carton. Make sure it contains all of the items listed in the table at the top of the next page. If not, contact an authorized Mark Levinson dealer.

Item	Quantity
Detachable AC power cord	1
Link communication cable	1
1/8-inch hex key	1
Phillips-head screwdriver (size 1)	1
N°326S remote control*	1
White gloves (pair)**	1
Warranty & Product Registration Card	1

* *The remote control comes with two AAA batteries, which should be replaced as needed.*

** *The white gloves are provided to assist with the initial unpacking and installation of the N°326S.*

Placement

- **DO** install the N°326S on a solid, flat, level surface such as a shelf or table.
- **DO** install the N°326S close to associated components to keep interconnect cabling as short as possible.

1-5

Note

In some cases, it is better to use longer interconnect cabling between the preamplifier and the power amplifier to allow for shorter loudspeaker wires.

- **DO** select a dry, well-ventilated location out of direct sunlight.
- **DO** allow at least a 4-inch clearance above the N°326S for proper heat dissipation. It is strongly recommended to install the N°326S on its own shelf for proper ventilation.
- **DO** refer to *Dimensions* (page A-3) for assistance with custom installations.
- **DO NOT** place the N°326S on a thick rug or carpet or cover the N°326S with a cloth, as this might prevent proper cooling.
- **DO NOT** expose the N°326S to high temperatures, humidity, steam, smoke, dampness, or excessive dust. Avoid installing the N°326S near radiators and other heat-producing appliances.

- **DO NOT** install the N°326S near unshielded TV or FM antennas, cable TV decoders, and other RF-emitting devices that might cause interference.
- **DO NOT** place the N°326S on a windowsill or in another location in which it will be exposed to direct sunlight.
- **DO NOT** obstruct the **IR receiver** located in the front panel display. When the N°326S is not using the **ir input** connector, the remote control **IR transmitter** must be in line-of-sight with the **IR receiver** for proper remote control operation.

CAUTION

BEFORE MOVING THE N°326S, MAKE SURE IT IS POWERED OFF WITH THE FRONT PANEL POWER BUTTON. THEN, MAKE SURE THE POWER CORD IS DISCONNECTED FROM THE ~ac mains CONNECTOR AND THE ELECTRICAL OUTLET.

WARNING

MAKE SURE ALL COMPONENTS ARE PROPERLY GROUNDED. DO NOT DEFEAT THE SAFETY PURPOSE OF POLARIZED OR GROUNDING-TYPE PLUGS WITH "GROUND-LIFTER" OR "CHEATER" ADAPTORS. DOING SO MAY CAUSE DANGEROUS VOLTAGES TO BUILD UP BETWEEN COMPONENTS. THE PRESENCE OF THESE VOLTAGES MAY RESULT IN PERSONAL INJURIES AND/OR PRODUCT DAMAGE.

1-6

Remote Control Batteries



The remote control comes with two AAA batteries, which should be replaced as needed. It is recommended to use Alkaline batteries, which do not leak and last longer.

To replace the remote control batteries:

1. Locate the battery compartment cover on the back of the remote control.
2. Use the supplied Phillips-head screwdriver (size 1) to remove the three screws that hold the battery compartment cover in place. These screws are identified in the illustration to the left.
3. Remove the battery compartment cover from the remote control.
4. Remove the old batteries inserted in the battery compartment (if applicable).

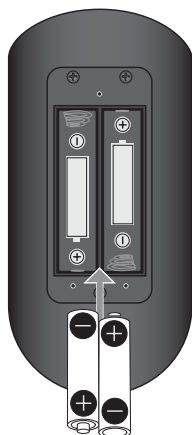

5. Insert two AAA batteries as shown in the illustration to the left. Make sure the batteries are correctly inserted observing the proper polarity.
6. Align the battery compartment cover with the guide on the back of the remote control.
7. Replace the three screws that were removed in step 2.
8. Properly dispose of the old batteries (if applicable).

Power Requirements

The N°326S can be powered with a standard 15amp AC power line. If other components are also connected to the AC power line, the combined power requirements of all components should be considered.

When shipped, the N°326S is configured for 100, 120, 220, or 230VAC power operation at 50 or 60Hz. In compliance with CE regulations, the N°326S is configured for 230VAC power operation at 50Hz in European Union countries. Before operating the N°326S, make sure the **~ac mains** connector label indicates the correct operating voltage for the current location.

1-7

CAUTION

- **DO NOT ATTEMPT TO ADJUST THE OPERATING VOLTAGE. CONSULT AN AUTHORIZED MARK LEVINSON DEALER IF THE OPERATING VOLTAGE IS INCORRECT OR IF THE OPERATING VOLTAGE MUST BE CHANGED FOR RELOCATION PURPOSES.**
 - **BE ADVISED THAT DIFFERENT OPERATING VOLTAGES MAY REQUIRE THE USE OF DIFFERENT POWER CORDS AND/OR ATTACHMENT PLUGS. CONTACT AN AUTHORIZED MARK LEVINSON DEALER FOR ADDITIONAL ASSISTANCE.**
-

Warm-Up & Break-In Period

Although the N°326S delivers superior performance from the first time it is powered on, this performance will continue to improve as the N°326S reaches its normal operating temperature and various components “break in.” The greatest performance improvements will occur within the first 25 to 50 hours of use. Sound quality will continue to improve for about 300 hours.

After this initial period, performance will remain consistent unless power is disconnected from the ~ac mains connector. Power is disconnected from the ~ac mains connector when the N°326S is powered off with the front panel **power button**; the power cord is disconnected from the ~ac mains connector or the electrical outlet; or an extended power failure or power outage occurs. Power is not disconnected from the ~ac mains connector when the N°326S is in standby.

When power returns, the N°326S will require a brief warm-up and break-in period (not the full 300 hours). It is recommended to allow the N°326S and other audio components to stabilize for about 2 minutes.

Note

- When powered on with the front panel **power button**, the N°326S automatically enters standby after completing the initialization sequence.
 - The **main output** connectors are muted while the N°326S performs the initialization sequence.
-

1-8

Continuous Operation

The N°326S should be unplugged during lightning storms and extended periods of non-use. Otherwise, it is designed for continuous operation. For best performance, make sure power is connected to the ~ac mains connector at all times. During normal operation, do not use the **power button** to power off the N°326S. Instead, use the front panel or remote control **standby button** to place the N°326S into standby, which allows the N°326S to remain warmed-up to deliver optimal performance at all times.

Quick Start Guide

These instructions are intended to accommodate immediate use of the N°326S. However, it is important to read this owner's manual before attempting more extensive use. This owner's manual contains information about features that enhance operation and performance, as well as important safety, installation, and operation instructions designed to prevent personal injuries as well as product damage.

CAUTION

NEVER MAKE OR BREAK CONNECTIONS TO THE N°326S UNLESS IT AND ALL ASSOCIATED COMPONENTS ARE POWERED OFF AND DISCONNECTED FROM ELECTRICAL OUTLETS.

To begin using the N°326S:

1. Make sure the N°326S and all associated components are powered off and disconnected from electrical outlets.

Note

The N°326S offers balanced (XLR) and single-ended (RCA) stereo connections. For best performance, use balanced (XLR) connections whenever possible. A balanced connection between the N°326S and the associated power amplifier will offer the highest possible performance with the best protection against RF interference and other common mode noise.

1-9

2. Connect the desired N°326S stereo **input connectors** to the source component (e.g., CD player) output connectors.
 - Use the N°326S balanced (XLR) stereo **input connectors** labeled 1, 2, or 3 if the source component offers balanced (XLR) output connectors.
 - Use the N°326S single-ended (RCA) stereo **input connectors** labeled 4, 5, 6, or 7 if the source component does not offer balanced (XLR) output connectors.
3. Connect the desired N°326S stereo **main output** connectors to the associated power amplifier.
 - Use the N°326S balanced (XLR) stereo **main output** connectors if the associated power amplifier offers balanced (XLR) input connectors.
 - Use the N°326S single-ended (RCA) stereo **main output** connectors if the associated power amplifier does not offer balanced (XLR) input connectors.

4. Reconnect the N°326S and all associated components to electrical outlets. Then, power on the N°326S and all associated components. It is recommended to power all power amplifiers on last.
5. Rotate the N°326S front panel **select knob** or press the remote control **select ± buttons** to select the N°326S input that corresponds to the N°326S stereo **input connectors** selected in step 2.
 - The N°326S front panel display indicates the name and volume level of the selected input.
 - Factory-default input names correspond to their assigned stereo **input connectors**. For instance, **Input 1** is assigned to the stereo **input connectors** labeled 1, **Input 2** is assigned to the stereo **input connectors** labeled 2, and so on.

2

Basic Operation

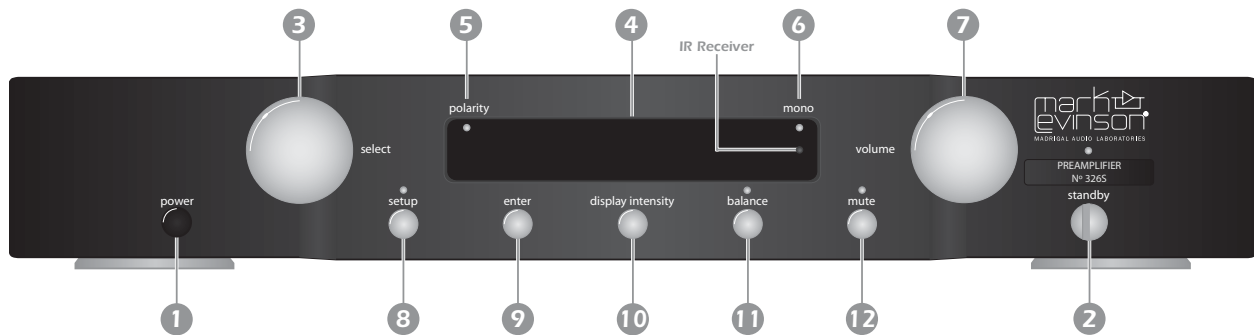

The numbers in the N°326S front panel illustration shown above correspond to the numbered items in the Front Panel Overview section that begins below.

Front Panel Overview

2-1

Unless otherwise specified, the numbered items in this section indicate the commands the front panel performs during normal operating mode. Refer to *Section 3: Setup Menu* and *Section 4: Controls & Modes* for information about other commands the front panel performs.

1. power button

Powers the N°326S on and off when the supplied power cord is connected to the **~ac mains** connector and an electrical outlet. When the N°326S is powered off, pressing the **power button** connects power to the **~ac mains** connector and powers on the N°326S. When powered on, the N°326S automatically enters standby after completing the initialization sequence. When the N°326S is powered on, pressing the **power button** disconnects power from the **~ac mains** connector and powers off the N°326S.

Note

Before operating the N°326S, make sure the **~ac mains** connector label indicates the correct operating voltage (page 1-7) for the current location.

2. **standby button & LED**

Places the N°326S into standby and takes the N°326S out of standby, which allows the N°326S to remain warmed-up to deliver optimal performance at all times. The front panel **standby LED** blinks red to indicate that the N°326S is in standby and lights red to indicate that the N°326S is not standby.

Note

Power is still connected to the **~ac mains** connector when the N°326S is in standby.

3. **select knob**

Selects the desired input. Rotating the **select knob** scrolls through all activated inputs. The front panel display indicates the name and volume level of the selected input. **Select knob** scrolling does not include deactivated inputs – inputs for which the **Name** parameter has been set to **unused**.

4. **front panel display**

Includes 12 alphanumeric characters that provide one-line viewing of information. During normal operating mode, the front panel display indicates the name and volume level of the selected input.

The right side of the front panel display includes an **IR receiver** that receives infrared commands from the remote control **IR transmitter** when the N°326S is not using the rear panel **ir input** connector. Refer to *Operation Considerations* (page 2-15) for additional information.

5. **polarity LED**

Lights red to indicate that **main output** signal polarity has been inverted with the remote control **polarity button**. Refer to *Polarity* (page 4-3) for additional information.

6. **mono LED**

Lights red to indicate that mono playback has been activated with the remote control **mono button**. Refer to *Mono Playback* (page 4-5) for additional information.

7. volume knob

Adjusts master volume level. Rotating the **volume knob** increases (clockwise) and decreases (counterclockwise) master volume level in 1.0dB increments up to 23.0dB and in 0.1dB increments above 23.0dB. The minimum master volume level setting is OFF. The **MaxVol** parameter can be used to determine the maximum master volume level setting in 0.1dB increments between 40.0 and 80.0dB. The factory-default maximum master volume level is 80.0dB.

The **Offset** parameter can be used to determine individual input volume level offsets in 0.1dB increments between -20.0 and +20.0dB. The factory-default input volume level offset is 0.0dB. Whenever an input is selected, the N°326S automatically applies the **Offset** parameter setting to master volume level.

Note the following about using the volume knob:

- Rotating the **volume knob** quickly accelerates the rate of change to accommodate large adjustments. Rotating the **volume knob** too quickly decelerates the rate of change to prevent accidental adjustments that could send dangerous signal levels to the loudspeakers.
- Rotating the **volume knob** slowly decelerates the rate of change to accommodate fine, precise adjustments.

2-3

Note

- The master volume control does not affect **record output** levels.
 - All N°326S volume controls, including master volume and **balance**, are deactivated when **SSP mode** (page 4-8) is activated.
-

8. setup button & LED

Opens and closes the **setup menu**, which can be used to configure the N°326S to suit individual preferences and listening spaces. The front panel **setup LED** lights red to indicate that the **setup menu** is open.

9. enter button

Selects and deselects menu items when the **setup menu** is open. The **enter button** performs no function during normal operating mode.

10. display intensity button

Controls the illumination level of front panel display characters and the front panel standby LED. Refer to *Display Intensity* (page 4-2) for additional information.

11. balance button & LED

Opens and closes the **balance** control, which can be used to control the left-to-right channel balance of the **main output** connectors. The front panel **balance LED** lights red to indicate that the **balance** control is open. Refer to *Balance* (page 4-3) for additional information.

Note

When the **balance** control is closed, the front panel **balance LED** remains lit if the left-to-right channel balance of the **main output** connectors is offset.

12. mute button & LED

Activates and deactivates mute. Pressing and releasing the **mute button** once activates mute and attenuates master volume by the selected mute level. The front panel **mute LED** lights red to indicate that mute is activated. Pressing and releasing the **mute button** again restores master volume to its original level.

The **Mute** parameter can be used to determine the amount of master volume level attenuation that occurs when mute is activated. The mute level can be set in 0.1dB increments between -10.0 and -80.0dB. The factory-default mute level is -20.0dB.

Note

Rotating the front panel **volume knob** deactivates mute, adjusting master volume from the muted volume level.

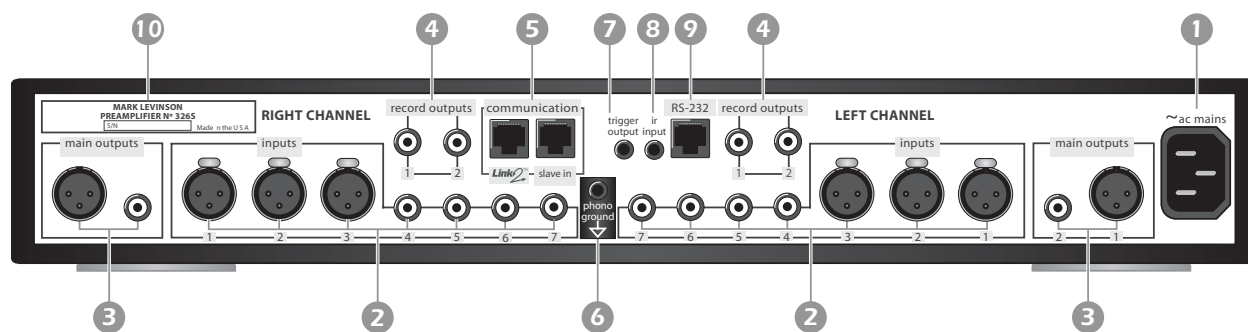

The numbers in the N° 326S rear panel illustration shown above correspond to the numbered items in the Rear Panel Overview section that begins below. For maximum channel separation, all left-channel connectors are located on one side of the rear panel and all right-channel connectors are located on the opposite side of the rear panel.

Rear Panel Overview

CAUTION

NEVER MAKE OR BREAK CONNECTIONS TO THE N°326S UNLESS IT AND ALL ASSOCIATED COMPONENTS ARE POWERED OFF AND DISCONNECTED FROM ELECTRICAL OUTLETS.

2-5

1. ~ac mains connector

Provides power to the N°326S through the supplied power cord when the supplied power cord is connected to the ~ac mains connector and the electrical outlet. One IEC-standard AC mains receptacle labeled ~ac mains is available.

Note

Before operating the N°326S, make sure the ~ac mains connector label indicates the correct operating voltage (page 1-7) for the current location.

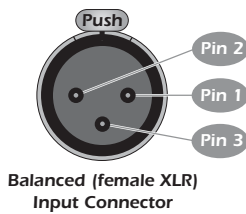
**Pin Assignments**

- Pin 1: Signal Ground
- Pin 2: Signal + (Non-Inverting)
- Pin 3: Signal - (Inverting)
- Connector Ground Lug: Chassis Ground

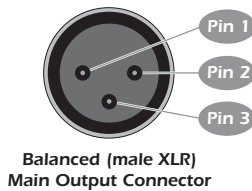

2-6

2. stereo input connectors

Provide left and right-channel analog audio input. For each channel, a set of balanced (female XLR) connectors is available to accept line-level balanced input signals from associated components that offer balanced (male XLR) output connectors. The connectors in each set are labeled 1-3. Two sets of four single-ended (RCA) connectors are available to accept line-level single-ended input signals from other associated components. The connectors in each set are labeled 4-7.

For best performance, use balanced connections whenever possible. Refer to the illustration to the left and to the associated component documentation to ensure that N°326S balanced **input connector** pin assignments correspond to the associated component balanced output connector pin assignments. If not, wire the cable so that the appropriate input pin connects to the appropriate output pin.

Note

- The single-ended (RCA) **input connector** labeled 7 becomes the **phono input connector** when the N°326S phono modules are installed.
- A balanced connection between the N°326S and the associated power amplifier will offer the highest possible performance with the best protection against RF Interference and other common mode noise.

3. stereo main output connectors

Provide left and right-channel analog audio output. One balanced (male XLR) connector per channel labeled 1 is available to output balanced signals to an associated power amplifier that offers balanced (female XLR) input connectors. One single-ended (RCA) connector per channel labeled 2 is available to output single-ended signals to other associated components, including power amplifiers that do not offer balanced (female XLR) input connectors.

For best performance, use balanced connections whenever possible. Refer to the illustration in the top-left corner of this page and to the associated power amplifier documentation to ensure that N°326S balanced output connector pin assignments correspond to the associated power amplifier balanced input connector pin assignments. If not, wire the cable so that the appropriate input pin connects to the appropriate output pin.

4. stereo record output connectors

Provide left and right-channel analog audio output at fixed levels. Two single-ended (RCA) connectors labeled 1 and 2 are available to output single-ended signals to recording components such as CD-Rs and tape decks.

The **Rec.Out** parameter can be used to assign the **record output** connectors to the desired input(s). It is recommended to use the **Name** parameter to associate inputs with the correct recording components to prevent possible record feedback loops.

Note

N°326S volume controls, including master volume and **balance**, do not affect **record output** levels.

5. **Link**™ & slave in communication ports

Provide “links” to compatible Mark Levinson components, allowing the N°326S and other linked components to share controls such as display intensity, standby, playback, input selection, and record. Two 8-pin modular RJ-45 jacks labeled **Link**™ and **slave in** are available.

2-7

The **Link**™ communication port can be connected to a Mark Levinson power amplifier that offers Link communication ports. The **slave in** communication port can be connected to a compatible Mark Levinson digital audio processor or digital transport that offers Link communication ports.

Note

Refer to **Linking** (page 2-9) **BEFORE** linking the N°326S to other Mark Levinson components.

6. phono ground connector

Provides an earth-reference ground connection for a phono cartridge. One binding post labeled **phono ground** is available for a phono grounding wire. Connecting the phono grounding wire to the **phono ground** connector grounds the phono cartridge to the N°326S chassis, which sometimes reduces audible hum and other noise that results from multiple grounding paths. Otherwise, the ground connection between the N°326S and the associated phono cartridge is isolated.

Note

Listen to the associated phono cartridge both with and without the phono ground connection. Then, select the connection that results in the best performance.

7. trigger output connector

Provides 12 or 5V DC output to control connected components. One 3.5mm mini-jack labeled **trigger output** is available for a mono plug (Tip/Sleeve) connection. The **Trig.** parameter can be used to configure the **trigger output** connector to provide 12 or 5V DC output.

8. ir input connector

Provides input of 5V infrared signals with no more than 100mA of current from standard infrared distribution equipment such as IR repeaters. One 3.5mm mini-jack labeled **ir input** is available for a mono plug (Tip/Sleeve) connection. The tip of the mono-plug must have positive polarity as shown in the illustration to the left.

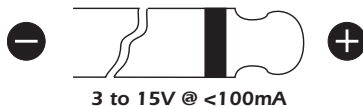
**9. RS-232 port**

Provides serial control, performing flash memory software upgrades and facilitating external control in AMX™ and Crestron™ systems. One 6-pin modular RJ-11 port labeled RS-232 is available.

10. serial number label

Indicates the N°326S serial number, which is required for product registration and warranty service.

Linking

Linking is available for all Mark Levinson components that offer Link communication ports, including **master**, **slave in**, **slave out**, and **Link2™** communication ports. These communication ports can be used to “link” compatible Mark Levinson components in a **slave chain**, allowing them to share controls such as display intensity, standby, playback, input selection, and record.

The N°326S offers two Link communication ports labeled **slave in** and **Link2™**. The **slave in** communication port can be connected to a compatible Mark Levinson digital audio processor or digital transport. The **Link2™** communication port can be connected to a compatible Mark Levinson power amplifier.

The N°326S is compatible with:

- All power amplifiers that offer Link or **Link2™** communication ports.
- N°30, N°30.5, and N°30.6 Reference Digital Audio Processors
- N°31 and N°31.5 Reference CD Transports
- N°36, N°36S, N°360, and N°360S Digital Audio Processors
- N°39 and N°390S CD Processors (can be used as either digital audio processors or digital transports in a **slave chain**)
- N°37 CD Transport
- Refer to the appropriate documentation for Link compatibility information about other Mark Levinson components.

2-9

Note

Linking is not available for Mark Levinson digital transports unless a Mark Levinson digital audio processor is included in the **slave chain**. Certain digital transport and digital audio processor combinations are not Link compatible. Refer to the appropriate owner's manual for additional information.

Making Link Connections

- **DO** use Link communication ports, such as **master**, **slave in**, **slave out**, and **Link2™** communication ports. **DO NOT** use RS-232 ports or other rear panel connectors.
- **DO** use supplied Link communication cables, which are provided in the N°326S accessory carton. Additional Link communication cables are available at authorized Mark Levinson dealers.

- **DO** use constructed Link communication cables (if desired). Refer to *Constructing Link Communication Cables* for additional information.

CAUTION

LINK CONNECTIONS MUST BE MADE USING LINK COMMUNICATION PORTS AND SUPPLIED OR CONSTRUCTED LINK COMMUNICATION CABLES. CONNECTIONS MADE USING OTHER CONNECTORS OR CABLES MAY DAMAGE THE N°326S AND OTHER LINKED COMPONENTS, POSSIBLY VOIDING THE MANUFACTURER'S WARRANTY AND/OR STANDARD REPAIR POLICIES.

Constructing Link Communication Cables

Link communication cables can be constructed using an 8-conductor modular telephone cable with the appropriate plug crimped on each end.

- Use an 8-pin RJ-45 plug to connect to a digital audio processor, digital transport, or N°326S. RJ-45 plugs provide an 8-pin connection.
- Use a 6-pin RJ-11 plug to connect to a power amplifier. RJ-11 plugs provide a 6-pin connection in which connector pins 7 and 8 are not used.

When linking components with constructed Link communication cables, twist the cable 180° as shown in the illustration below for a straight-through (pin 1-to-pin 1) connection.

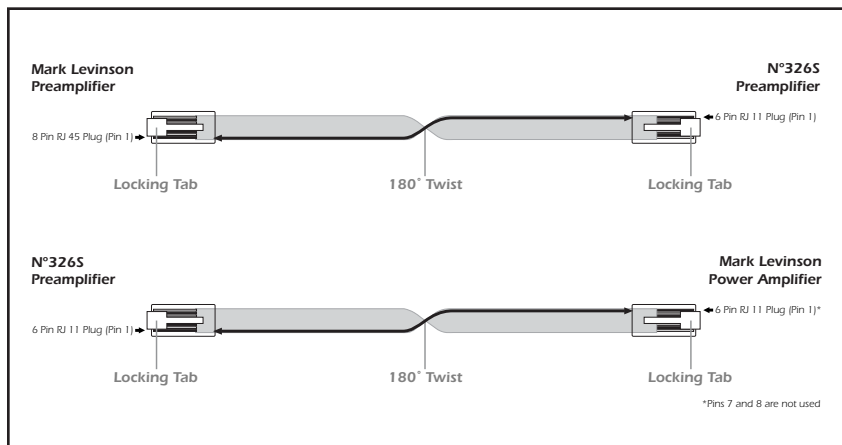

Creating a Slave Chain

Making Link connections creates a **slave chain** that facilitates communication among linked components, allowing them to share certain controls. The table on the next page indicates **slave chain** requirements for each component.

All slave chains:

- Must include compatible Mark Levinson components. The N°326S is compatible with the components listed on page 2-9. Refer to the appropriate documentation for Link compatibility information about other Mark Levinson components.
- Must connect components in a certain order to prevent communication from terminating. In general, components must be linked as follows: digital audio processor, to digital transport, to N°326S, to power amplifier.

Note

Link communication port names differ among Mark Levinson components. The Link communication port names used in the table below correspond with the component listed in the Component column.

Component	Requirements & Connections
<p>Digital Audio Processor* (e.g., N°360S)</p>	<ul style="list-style-type: none"> • Serves as the master component in the slave chain. • Maximum of one per slave chain. • Connect the master communication port on the digital audio processor to the slave in communication port on the first digital transport. If no digital transports are included in the slave chain, connect the master communication port on the digital audio processor to the slave in communication port on the N°326S.
<p>Digital Transport* (e.g., N°37)</p>	<ul style="list-style-type: none"> • No maximum number per slave chain. • Must be positioned after the digital audio processor and before the N°326S and power amplifier(s). • Connect the slave in communication port on the first digital transport to the master communication port on the digital audio processor. Digital transports CANNOT be included in a slave chain that does not include a compatible Mark Levinson digital audio processor. • Connect multiple digital transports in a “daisy chain” using slave out-to-slave in communication port connections. Connect the slave out communication port on the last digital transport to the slave in communication port on the N°326S.
<p>Preamplifier (e.g., N°326S)</p>	<ul style="list-style-type: none"> • No maximum number per slave chain. • Connect the slave in communication port on the N°326S to the slave out communication port on the last digital transport. If no digital transports are included in the slave chain, connect slave in communication port on the N°326S to the master communication port on the digital audio processor. • Connect the Link² communication port on the N°326S to the Link² input communication port on the first power amplifier.
<p>Power Amplifier (e.g., N°432)</p>	<ul style="list-style-type: none"> • Maximum of six per slave chain. • Connect the Link² input communication port on the first power amplifier to the Link² communication port on the N°326S. • Connect up to six power amplifiers in a “daisy chain” using Link² input-to-Link² control communication port connections. The Link² control communication port on the last power amplifier is not connected.

* The N°39 and N°390S CD Processors can serve as either a digital audio processor or a digital transport in a **slave chain**.

To create a slave chain that includes the N°326S:

1. Load a disc in a digital transport that will be included in the **slave chain** (if applicable).
2. Make sure the N°326S and all associated components are powered off.
3. Refer to the table on the previous page and the illustration on the next page to make Link connections. In general, components must be linked as follows: digital audio processor, to digital transport, to N°326S, to power amplifier.
4. When Link connections have been made, power on linked components **ONE AT A TIME** in the order specified below. Allow each component to complete the initialization sequence before proceeding to the next component.
 - A. Digital Transport(s)
 - B. Digital Audio Processor
 - C. N°326S
 - D. Power Amplifier(s)

At this point, the front panel **standby LEDs** on all linked components should be blinking in unison.

Note

Linked components must be powered on **ONE AT A TIME** in the specific order listed in step 4 (above) to ensure proper functioning of Link controls. Do not use a power strip switch to power on several components at once. When power is supplied to a power strip, connected components that do not include a power button will automatically power on.

5. Play the input source on the digital transport selected in step 1 (if applicable).
 - All linked components should automatically come out of standby.
 - The linked digital audio processor and N°326S should automatically select the appropriate input.

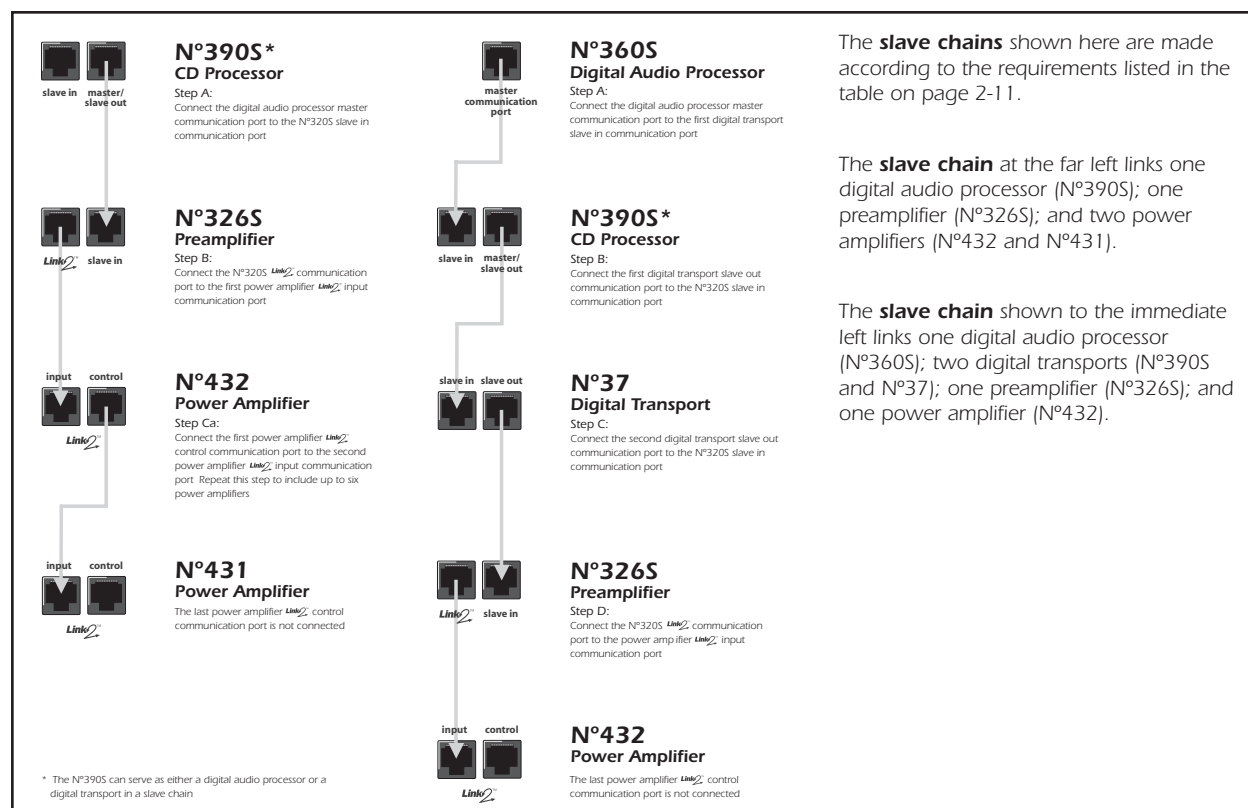

The **slave chains** shown here are made according to the requirements listed in the table on page 2-11.

The **slave chain** at the far left links one digital audio processor (N°390S); one preamplifier (N°326S); and two power amplifiers (N°432 and N°431).

The **slave chain** shown to the immediate left links one digital audio processor (N°360S); two digital transports (N°390S and N°37); one preamplifier (N°326S); and one power amplifier (N°432).

Link Controls

Linking Mark Levinson components allows them to share controls such as display intensity, standby, playback, input selection, and record.

Note the following:

- Linked components must be powered on **ONE AT A TIME** in the specific order listed in step 4 (page 2-12) to ensure proper functioning of Link controls.
- Link controls must be enabled on the linked digital transport(s) linking menu, which allows activation and deactivation of individual Link controls. Refer to the appropriate digital transport owner’s manual for additional information.
- Some Mark Levinson digital transports accommodate a maximum of four front panel display characters. In these cases, certain input names appear abbreviated on the front panel display. For example, an input named N°326S will appear as N°32 on the digital transport front panel display even though the input is associated with the N°326S.
- The linked N°326S and power amplifier(s) must be in the same standby-state to allow the linked power amplifier(s) to enter standby after a power failure.

The table below provides a general description of controls the N°326S shares with other linked components. Some controls may not be available for certain component combinations. Other Mark Levinson components may share additional controls. Refer to the appropriate documentation for additional information.

Component Link Controls	Digital Audio Processor	Digital Transport	Preamplifier (N°326S)	Power Amplifier
Display Intensity Link	Maintains consistent front panel display character illumination among all linked components. Adjusting display intensity for one linked component simultaneously adjusts display intensity for all other linked components.			
Standby Link	Placing the linked digital audio processor into standby also places all linked digital transports into standby. Taking the linked digital audio processor out of standby also takes the linked N°326S out of standby.	Taking the linked digital transport(s) out of standby also takes the linked N°326S and power amplifier(s) out of standby.	Placing the linked N°326S into standby also places all other linked components into standby. Taking the linked N°326S out of standby also takes the linked power amplifier(s) out of standby.	Placing a linked power amplifier into standby also places all other linked power amplifiers into standby. Likewise, taking a linked power amplifier out of standby also takes all other linked power amplifiers out of standby.
Playback Link	Pressing the play button on a linked digital transport automatically takes the linked digital audio processor, N°326S, and power amplifier(s) out of standby and selects the associated input on the linked digital audio processor and N°326S.			
Input Selection Link	Pressing and holding the digital transport remote control select button toggles between selecting digital transports on the linked digital audio processor and selecting analog inputs on the linked N°326S. Pressing and releasing the digital transport remote control select button scrolls through all available digital or analog inputs (depending on whether the digital audio processor or N°326S is selected). The digital transport front panel display indicates the name and volume level of the selected input.			N/A
Record Link	Placing the linked N°326S into standby will not place the linked N°30, N°30.5, N°30.6, N°31, or N°31.5 into standby: <ul style="list-style-type: none"> • if the linked digital audio processor is in Record Mode • if the linked digital transport is in Record Link Mode A warning message will appear on the linked digital audio processor and digital transport to indicate that these components are involved in a recording session.			N/A
HDCD™ Link	Configuring the linked digital audio processor for an HDCD recording session automatically attenuates the linked N°326S master volume level the required -6dB.	N/A	Configuring the linked digital audio processor for an HDCD recording session automatically attenuates the linked N°326S master volume level the required -6dB.	N/A

Note

The N°31, N°31.5, N°37, and N°39 remote controls can be used to control N°326S master volume level. This command is available over IR (not Link connections). Before using one of these remote controls to adjust N°326S master volume level, make sure the digital transport setup menu volume control parameter is set to fixed.

Remote Control Overview

The N°326S remote control provides full operation of the N°326S. Unless otherwise specified, the numbered items in the *Command Overview* section (next page) indicate the commands the remote control performs during normal operating mode. Refer to *Section 3: Setup Menu* and *Section 4: Controls & Modes* for information about other commands the remote control performs.

Operation Considerations

The remote control requires special consideration during operation to ensure optimal performance. Pay particular attention to the bulleted items below and to other precautions that appear throughout this user guide. **The bulleted items that begin below are not applicable when the N°326S is using the rear panel ir input connector.**

- **DO** eliminate obstructions between the remote control **IR transmitter** and the front panel display **IR receiver**.
- **DO** position the remote control within $\pm 45^\circ$ of a line that is perpendicular to the front panel display **IR receiver**. At more severe angles, attempt to “bounce” the remote control signal off a wall or another surface so the signal is received at the **IR receiver** at a reasonable angle.
- **DO** position the remote control within 17 feet (5m) of the front panel display **IR receiver**. If the N°326S is placed inside a glass cabinet, tinted glass will reduce the remote control range.
- **DO** replace the remote control batteries as needed. Refer to *Remote Control Batteries* (page 1-6) for additional information.
- **DO NOT** obstruct the front panel display **IR receiver**.
- **DO NOT** expose the front panel display **IR receiver** to strong sunlight, halogen light, or fluorescent light. This can cause IR reception to become unreliable.

Command Overview

- **DO NOT** use remote controls for different components at the same time. Remote controls for different components can interfere with one another.

Unless otherwise specified, the numbered items in this section indicate the commands the remote control performs during normal operating mode. Refer to *Section 3: Setup Menu* and *Section 4: Controls & Modes* for information about other commands the remote control performs.

1. IR transmitter

Sends infrared signals to the front panel display **IR receiver** when the N°326S is not using the rear panel **ir input** connector. Refer to *Operation Considerations* (previous page) for additional information.

2-16

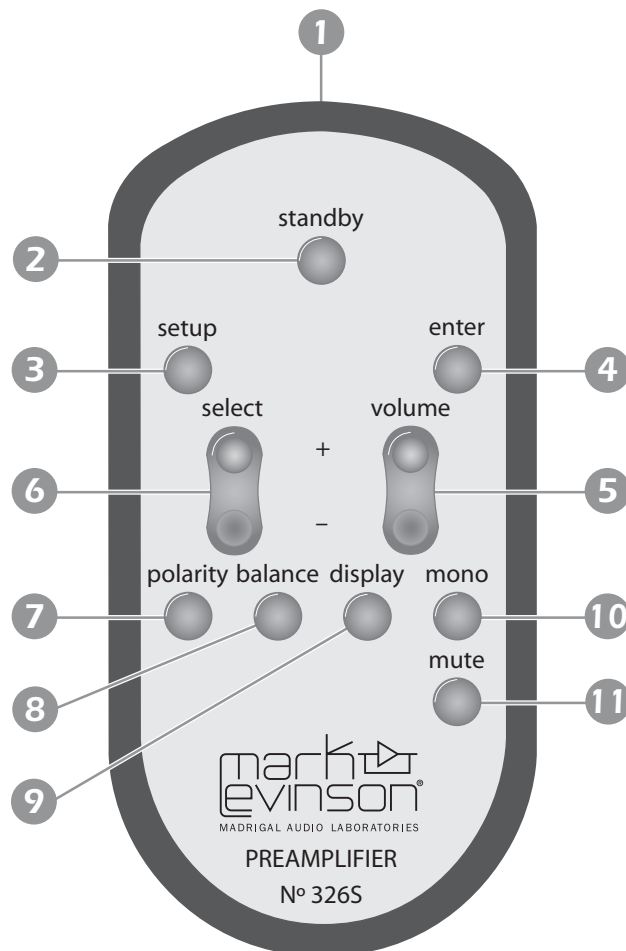

2. standby button

Places the N°326S into standby and takes the N°326S out of standby, which allows the N°326S to remain warmed-up to deliver optimal performance at all times. The front panel **standby LED** blinks red to indicate that the N°326S is in standby and lights red to indicate that the N°326S is not in standby.

Note

Power is still connected to the **~ac mains** connector when the N°326S is in standby.

3. setup button

Opens and closes the **setup menu**, which can be used to configure the N°326S to suit individual preferences and listening spaces. The front panel **setup LED** lights red to indicate that the **setup menu** is open.

The numbers in the N°326S remote control illustration shown above correspond to the numbered items in the Command Overview section that begins on this page.

4. enter button

Selects and deselects menu items when the **setup menu** is open. The **enter button** performs no function during normal operation.

5. volume ± buttons

Adjust master volume level. Pressing the **volume ± buttons** increases (+) and decreases (–) master volume level in 1.0dB increments up to 23.0dB and in 0.1dB increments above 23.0dB. The minimum master volume level setting is OFF. The **MaxVol** parameter can be used to determine the maximum master volume level setting in 0.1dB increments between 40.0dB and 80.0dB. The factory-default maximum master volume level is 80.0dB.

The **Offset** parameter can be used to determine individual input volume level offsets in 0.1dB increments between –20.0dB and +20.0dB. The factory-default input volume level offset is 0.0dB. Whenever an input is selected, the N°326S automatically applies the **Offset** parameter setting to master volume level.

Note the following about using the volume ± buttons:

2-17

- Pressing and releasing the **volume ± buttons** accommodates fine, precise adjustments.
- Pressing and holding the **volume ± buttons** for longer than 1.5 seconds accelerates the rate of change to accommodate large adjustments.

Note

- The master volume control does not affect **record output** levels.
 - All N°326S volume controls, including master volume and **balance**, are deactivated when **SSP mode** (page 4-8) is activated.
-

6. select ± buttons

Select the desired input. Pressing the **select ± buttons** scrolls through all activated inputs. The front panel display indicates the name and volume level of the selected input. **Select ± button** scrolling does not include deactivated inputs – inputs for which the **Name** parameter has been set to **unused**.

7. **polarity button**

Controls the polarity of the **main output** signal. Pressing and releasing the **polarity button** toggles between inverting and restoring **main output** signal polarity. The front panel **polarity LED** lights red to indicate that **main output** signal polarity is inverted. The **polarity button** has no affect on **record output** signal polarity. Refer to *Polarity* (page 4-3) for additional information.

8. **balance button**

Opens and closes the **balance** control, which can be used to control the left-to-right channel balance of the **main output** connectors. The front panel **balance LED** lights red to indicate that the **balance** control is open. Refer to *Balance* (page 4-3) for additional information.

Note

When the **balance** control is closed, the front panel **balance LED** remains lit if the left-to-right channel balance of the **main output** connectors is offset.

9. **display button**

Controls the illumination level of front panel display characters and the front panel standby LED. Refer to *Display Intensity* (page 4-2) for additional information.

10. **mono button**

Activates and deactivates the selected mode of mono playback. The front panel **mono LED** lights red to indicate that the mono playback is activated. Refer to *Mono Playback* (page 4-5) for additional information.

11. **mute button**

Activates and deactivates mute. Pressing and releasing the **mute button** once activates mute and attenuates master volume by the selected mute level. The front panel **mute LED** lights red to indicate that mute is activated. Pressing and releasing the **mute button** again restores master volume to its original level.

The **Mute** parameter can be used to determine the amount of master volume level attenuation that occurs when mute is activated. The mute level can be set in 0.1dB increments between -10.0dB and -80.0dB. The factory-default mute level is -20.0dB.

Note

Pressing the **volume ± buttons** deactivates mute, adjusting master volume from the muted volume level.

3

Setup Menu

Navigating the Setup Menu

The front panel and remote control **setup** buttons provide convenient access to the **setup menu** structure shown below, which can be used to configure the N°326S to suit individual preferences and listening spaces.

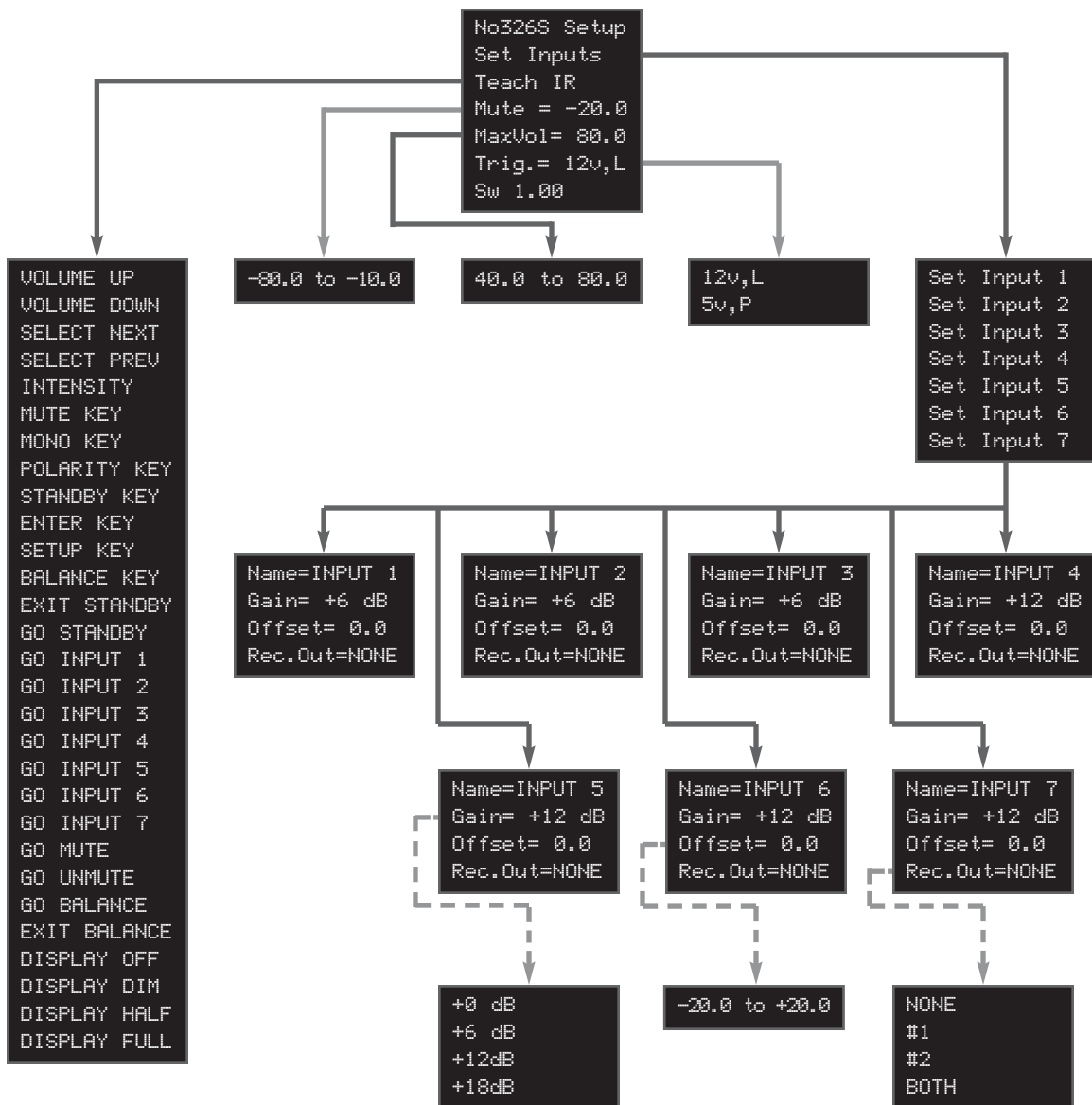

The front panel display provides one-line viewing of the setup menu shown here, indicating the current menu item.

To open the setup menu:

Press and release the front panel or remote control **setup button**.

When the **setup menu** is closed, pressing and releasing the **setup button** opens the **setup menu** on the front panel display as shown to the left. The front panel **setup LED** lights red to indicate that the **setup menu** is open.

No326S Setup

Both the front panel and remote control can be used to navigate the **setup menu** structure shown in the illustration on the previous page. The bulleted items that begin below indicate the commands the front panel and remote control perform when the **setup menu** is open.

setup button

- Returns to the previous menu, eventually closing the **setup menu**.
- Deselects the selected parameter without saving setting adjustments that have not been previously stored. The **RESTORING** message will appear on the front panel display as shown to the left to indicate that new adjustments are not being stored.

RESTORING

enter button

- Advances to the next menu.
- Selects the current parameter. When a parameter is selected, the equal sign (=) between the parameter label and the parameter setting will blink to indicate that setting adjustments can be made with the **volume knob** or **volume ± buttons**.
- Deselects the selected parameter, saving setting adjustments that have not been previously stored. The **SAVING DATA** message will appear on the front panel display as shown to the left to indicate that new adjustments are being stored.

SAVING DATA

Note

When a parameter is deselected, the **NO CHANGE** message will appear on the front panel display as shown to the left if no changes have been made to the parameter's last stored setting.

NO CHANGE

select knob & ± buttons

Scroll through menu items. Rotating the **select knob** or pressing the **select ± buttons** scrolls upward (clockwise/+) and downward (counterclockwise/-) through all menu items available on the open menu. The front panel display indicates the current menu item.

volume knob & ± buttons

Adjusts the selected parameter setting. Rotating the **volume knob** or pressing the **volume ± buttons** increases (clockwise/+) and decreases (counterclockwise/-) the selected parameter setting in the designated increment. The front panel display indicates the current setting. (If the current parameter has not been selected with the **enter button**, rotating the **volume knob** or pressing the **volume ± buttons** automatically selects the current parameter before making adjustments.)

Set Inputs Menu

Selecting **Set Inputs** prompts the selection of the desired input (for example, **Input 1**). Selecting an input opens the corresponding **Set Inputs** menu as shown below, which can be used to change input names, optimize input gain levels, offset input volume levels, and assign **record output** connectors.

3-3

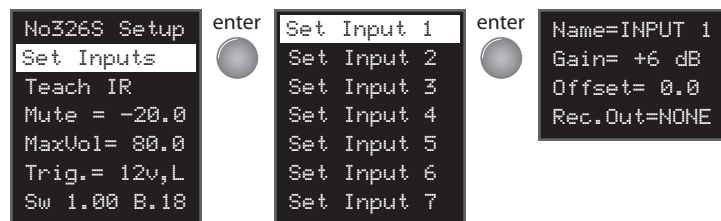

Input 1 is used here as an example and will continue to be used as an example throughout this section.

Parameter	Default Setting	Possible Settings
Name	INPUT	Factory-Default, Custom
Gain	+6dB or +12dB*	+0dB, +6dB, +12dB, +18dB
Offset	0.0dB	-20.0dB to +20.0dB
Rec.Out	NONE	NONE, #1, #2, BOTH

* The factory-default **Gain** parameter setting is +0dB for **Inputs 1-3** and +6dB for **Inputs 4-7**.

Set Inputs Menu Shortcut

The **Set Inputs** menu shortcut provides convenient access to the **Set Inputs** menu for the selected input. When this shortcut is used, the four **Set Inputs** menu parameters for the selected input – **Name**, **Gain**, **Offset**, and **Rec.Out** – are available. No other **setup menu** items are available.

To use the Set Inputs menu shortcut for the selected input:

1. Rotate the front panel **select knob** or press the remote control **select ± buttons** to select the desired input. The front panel display indicates the name and volume level of the selected input.
2. Press and hold the front panel or remote control **setup button** until the **Name** parameter for the selected input appears on the front panel display as shown to the left.



Name=INPUT 1

The front panel **setup LED** lights red to indicate that the **setup menu** is open.

Name

Factory-Default, Custom

Determines the name of the selected input. Factory-default input names correspond to their assigned stereo **input connectors**. For instance, **Input 1** is assigned to the stereo **input connectors** labeled 1, **Input 2** is assigned to the stereo **input connectors** labeled 2, and so on. Custom input names should be based on the component with which the input is associated. For instance, DVD is an appropriate custom name for an input associated with a DVD player. Two methods are available for customizing input names: the **custom names list** and the **character list**.

Note

Linked Mark Levinson components must have recognizable custom input names to share Link controls. For instance, an input associated with a N°360S Digital Audio Processor should be named N°360S. In some cases, linked components will assign correct input names for other linked, associated components. Otherwise, use the **custom names list** to enter the correct input name.

Custom Names List

The **custom names list** shown in the top-left corner of the next page provides convenient access to 28 custom input names that can be used for the most common associated components, including other Mark Levinson components. It also includes custom input names that can be used to deactivate **unused** inputs or to activate **SSP mode**. The table on the next page indicates the intended use of all custom input names available on the **custom names list**.

Custom Names List

- INPUT 1-7
- unused
- SSP
- SACD
- DAT
- VCR
- CASS
- RtoR
- MD
- CD-R
- SAT
- LD
- CD
- TUNER
- AUX
- DAC
- TAPE
- DVD
- N°30
- N°30.5
- N°30.6
- N°35
- N°36
- N°36S
- N°360
- N°360S
- N°39
- N°390S

Custom Name	Description
INPUT 1-7	Identifies the factory-default input name. This name can be customized one character at a time using the character list (next page).
unused	Removes the selected input from select knob and select ± button scrolling.
SSP	<p>Activates SSP (surround sound processor) mode, which configures the selected input for complete integration with a multi-channel surround sound processor.</p> <p>CAUTION BEFORE ACTIVATING SSP MODE, SET THE ASSOCIATED SURROUND SOUND PROCESSOR VOLUME CONTROL TO A REASONABLE LEVEL TO PREVENT SENDING DANGEROUS SIGNAL LEVELS TO THE LOUDSPEAKERS.</p>
SACD	Identifies an input associated with a super audio compact disc player or a digital versatile disc player capable of super audio compact disc playback.
DAT	Identifies an input associated with a digital audio tape transport.
VCR	Identifies an input associated with a video cassette recorder.
CASS	Identifies an input associated with a cassette deck.
RtoR	Identifies an input associated with a reel-to-reel player.
MD	Identifies an input associated with a mini-disc player.
CD-R	Identifies an input associated with a compact disc recorder.
SAT	Identifies an input associated with a satellite receiver.
LD	Identifies an input associated with a laser disc player.
CD	Identifies an input associated with a compact disc player.
TUNER	Identifies an input associated with a tuner.
AUX	Identifies an input associated with an auxiliary component.
DAC	Identifies an input associated with a digital-to-analog converter.
TAPE	Identifies an input associated with a tape deck.
DVD	Identifies an input associated with a digital versatile disc player.
N°30, N°30.5, N°30.6, N°35, N°36, N°36S, N°360, N°360S, N°39, N°390S	Identifies an input associated with the corresponding Mark Levinson component. Linked Mark Levinson components must have recognizable custom input names to share Link controls. For instance, an input associated with a N°360S Digital Audio Processor should be named N°360S. In some cases, linked components will assign correct input names for other linked, associated components. Otherwise, use the custom names list to enter the correct input name.

- Select this character (if the **character list** option was selected in step 3). The blinking cursor will advance to the next character space. Repeat steps 4 and 5 until all desired characters have been entered. When the seventh character is selected, the **SAVING DATA** message will appear on the front panel display to indicate that the new input name is being saved.

Note

The factory-default input name must be restored one character at a time using the **character list** (unless factory-default settings are restored).

Gain

+0dB, +6dB, +12dB, +18dB

Optimizes gain levels for the input using the stereo **input connector** for which the selected input is assigned. Increasing the **Gain** parameter setting increases gain levels for the selected input, which sometimes prevents input sources with low gain levels from producing low signal-to-noise ratios. Decreasing the **Gain** parameter setting decreases gain levels for the selected input, which sometimes prevents input sources with high gain levels from producing distortion.

3-7

Note

The **Gain** parameter should be set before the **Offset** parameter.

Offset

-20.0dB to +20.0dB

Determines individual input volume level offsets in 0.1dB increments between -20.0dB and +20.0dB. The factory-default input volume level offset is 0.0dB. Whenever an input is selected, the N°326S automatically applies the **Offset** parameter setting to master volume level.

In some cases, this causes some input sources to sound softer or louder than others. If this occurs, select the **Offset** parameter setting that compensates for the volume level difference, allowing all associated components to output at a comparable volume level.

Rec.Out
NONE, #1, #2, BOTH

Assigns **record output** connectors to the selected input. The rear panel offers two single-ended (RCA) stereo **record output** connectors that pass audio at fixed volume levels. When an input is assigned for the **record output** connectors, the input signal is sent to both the assigned **main** and **record output** connectors. The master volume, **balance**, and **polarity** controls do not affect **record output** levels.

Select the NONE setting to assign no **record output** connectors to the selected input. Select the #1 setting to assign the stereo **record output** connector labeled 1 to the selected input. Select the #2 setting to assign the stereo **record output** connector labeled 2 to the selected input. Select the BOTH setting to assign both **record output** connectors to the selected input.

CAUTION

IF THE ASSOCIATED COMPONENT OFFERS BOTH RECORD INPUT AND OUTPUT CONNECTORS, IT IS RECOMMENDED TO SET THE REC.OUT PARAMETER TO NONE TO PREVENT RECORD FEEDBACK LOOPS IN WHICH THE ASSOCIATED COMPONENT ATTEMPTS TO RECORD ITS OWN OUTPUT SIGNALS. THESE FEEDBACK LOOPS PRODUCE HIGH-LEVEL NOISE THAT MAY DAMAGE THE LOUDSPEAKERS AND/OR OTHER ASSOCIATED COMPONENTS.

Note

If the associated component connected to the **record output** connectors is also connected to a separate ground (such as a VCR with a cable TV connection), it is recommended to set the **Rec.Out** parameter for all activated inputs to NONE unless a recording session is in progress. This helps prevent low-level electrical noise from degrading performance.

Teach IR Menu

Selecting **Teach IR** opens the menu shown in the top-left corner of the next page, which prompts the selection of the desired IR command. Selecting an IR command sends the associated infrared signal from the left side of the front panel display to a learning remote control, allowing N°326S IR commands to be sent from a learning remote control even if the N°326S remote control is not present.

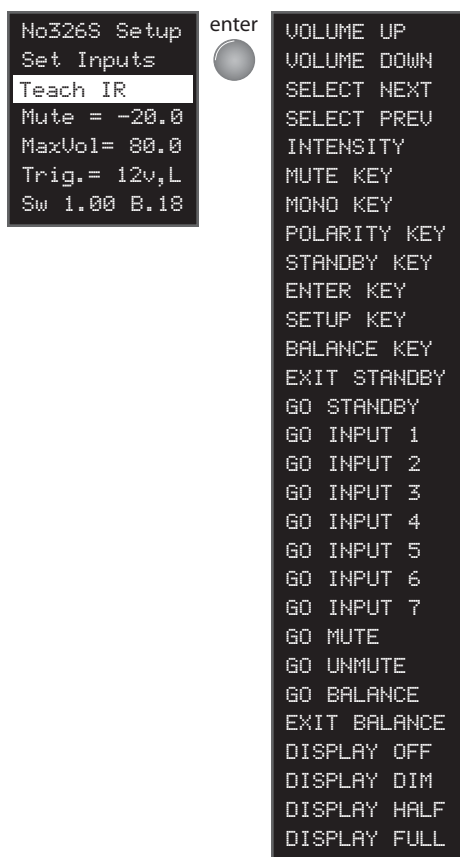

The N°326S sends infrared signals at 40kHz, the most common carrier frequency used in learning remote controls. However, if the learning remote control seems unable to learn IR commands:

- Eliminate obstructions between the learning remote control and the left side of the front panel display.
- Adjust the distance between the learning remote control and the left side of the front panel display.
- Make sure the learning remote control and the left side of the front panel display are not exposed to strong sunlight, halogen light, or fluorescent light. This can cause IR reception to become unreliable.
- Replace the learning remote control batteries.
- If problems persist, contact an authorized Mark Levinson dealer.

The table below indicates all available IR commands. For toggle commands, the N°326S provides one IR command for the toggle command as well as separate IR commands for the positive and negative forms of the toggle command. For instance, the **MUTE KEY** IR command teaches the learning remote control to perform **mute button** commands, while the **GO MUTE** IR command teaches the learning remote control to activate mute and the **GO UNMUTE** IR command teaches the learning remote control to deactivate mute.

Command	Description	Command	Description
VOLUME UP	Performs volume + button commands.	EXIT STANDBY	Takes the N°326S out of standby.
VOLUME DOWN	Performs volume – button commands.	GO STANDBY	Places the N°326S into standby.
SELECT NEXT	Performs select + button commands.	GO INPUT 1-7	Selects the input assigned for the corresponding stereo input connector (1-7).
SELECT PREV	Performs select – button commands.		
INTENSITY KEY	Performs display button commands.	GO MUTE	Activates mute.
MUTE KEY	Performs mute button commands.	GO UNMUTE	Deactivates mute.
MONO KEY	Performs mono button commands.	GO BALANCE	Opens the balance control.
POLARITY KEY	Performs polarity button commands.	EXIT BALANCE	Closes the balance control
STANDBY KEY	Performs standby button commands.	DISPLAY OFF	Sets display intensity to 0%.
ENTER KEY	Performs enter button commands.	DISPLAY DIM	Sets display intensity to 25%.
SETUP KEY	Performs setup button commands.	DISPLAY HALF	Sets display intensity to 50%.
BALANCE KEY	Performs balance button commands.	DISPLAY FULL	Sets display intensity to 100%.

To teach N°326S IR commands to a learning remote control:

1. Prepare the learning remote control to receive IR commands.
2. Follow the instructions on page 3-2 to open the **setup menu**.
3. Rotate the front panel **select knob** or press the remote control **select ± buttons** until **Teach IR** is selected.
4. Press the front panel or remote control **enter button** to open the **Teach IR** menu.

The **VOLUME UP** IR command will appear on the front panel display.

5. Rotate the front panel **volume knob** or press the remote control **volume ± buttons** to scroll through all available IR commands.
6. When the desired IR command is selected, press the **enter button** to teach this command to the learning remote control.

The **SENDING -->** message will appear on the front panel display as shown to the left to indicate that the associated infrared signal is being sent to the learning remote control.

7. Repeat steps 5 and 6 until all desired IR commands have been sent.

Note

The N°31, N°31.5, N°37, N°39, and N°390S remote controls can be used to control N°326S master volume level. This command is available over IR (not Link connections). Before using one of these remote controls to adjust N°326S master volume level, make sure the digital transport setup menu volume control parameter is set to fixed.

Setup Menu Parameters

Parameter	Default Setting	Possible Settings
Mute	-20.0dB	-10.0dB to -80.0dB
MaxVol	80.0dB	40.0dB to 80.0dB
Trig.	12v,L	12v,L; 5v,P
Sw	x.XX	x.XX

Mute -10.0dB to -80.0dB

Determines the amount of master volume level attenuation that occurs when mute is activated with the front panel or remote control **mute button**. The mute level can be set in 0.1dB increments between -10.0dB and -80.0dB. The factory-default mute level is -20.0dB.

MaxVol 40.0dB to 80.0dB

Determines the maximum master volume level setting in 0.1dB increments between 40.0dB and 80.0dB. The factory-default maximum master volume level is 80.0dB.

Trig. 12v,L; 5v,P

Configures the **trigger output** signal. Selecting the 12v,L setting configures the **trigger output** connector to send a 12V, level (constant) signal to the connected component whenever the N°326S is taken out of standby. This signal is not present when the N°326S is placed into standby. Selecting the 5v,P signal configures the **trigger output** connector to send a 5V pulse signal, similar to that of a momentary contact switch, to the connected component whenever the **standby button** is pressed. This signal is only present when the **standby button** is pressed.

Sw Non-adjustable

Indicates the current software version operating in the N°326S, allowing for quick comparison between the current software version and most current software version available. Software upgrades can be performed with the **RS-232** port, allowing software to be upgraded without disassembling the N°326S or disconnecting it from other components.

4

Controls & Modes

Standby

Allows the N°326S to remain warmed-up to deliver optimal performance at all times. The N°326S cannot be placed into standby unless it is powered on with the front panel **power button**. Refer to *Continuous Operation* (page 1-8) for additional information.

To place the N°326S into or take the N°326S out of standby:

1. Make sure the N°326S is powered on with the front panel **power button**.
2. Press and release the front panel or remote control **standby button**.
 - When the N°326S is not in standby, pressing and releasing the **standby button** places the N°326S into standby. The front panel **standby LED** blinks red to indicate that the N°326S is in standby.
 - When the N°326S is in standby, pressing and releasing the **standby button** takes the N°326S out of standby. The front panel **standby LED** lights red to indicate that the N°326S is not in standby.

4-1

Note

When powered on with the front panel **power button**, the N°326S automatically enters standby after completing the initialization sequence.

SLEEP

-OFF-, 0h 30m to 4h 0m

Controls the sleep timer, which configures the N°326S to automatically enter standby after a designated amount of time has passed. The **SLEEP** parameter can be set to -OFF- or in 30-minute increments between 30 minutes and 4 hours. The factory-default **SLEEP** parameter setting is -OFF-.

When the –OFF– setting is selected, the N°326S does not automatically enter standby. When a time increment setting is selected, the N°326S automatically enters standby after the designated amount of time has passed. For example, if the 2h 30m setting is selected, the N°326S automatically enters standby after 2 hours and 30 minutes have passed.

To set the sleep timer:

1. Follow the instructions on the previous page to take the N°326S out of standby.
 2. Press and hold the front panel or remote control **standby button** until the **SLEEP** parameter opens on the front panel display as shown to the left.
- 
3. Press and release the **standby button** to cycle through all available **SLEEP** parameter settings.
 4. When the desired setting is selected, press the front panel or remote control **enter button** to close the **SLEEP** parameter.
 - Otherwise, the **SLEEP** parameter automatically closes a few seconds after the last command is received. If this occurs, the selected setting is automatically applied.

Note

The **SLEEP** parameter is set to –OFF– whenever the N°326S is placed into standby.

Display Intensity

Controls the illumination of front panel display characters and the front panel standby LED. Four illumination levels are available, including FULL (100%), HALF (50%), DIM (25%), and OFF (0%). The factory-default illumination level is FULL (100%).

When the OFF (0%) illumination level is selected:

- The front panel display automatically activates whenever a change in status is detected.
- The front panel standby LED lights at the FULL (100%) illumination level.

To adjust display intensity:

Press and release the front panel **display intensity button** or the remote control **display button** to cycle through the four available illumination levels.

Front panel display characters and the front panel standby LED automatically adjust to the selected illumination level.

Polarity

Controls the polarity of the **main output** signal, whether that signal is using the balanced (XLR) or single-ended (RCA) **main output** connectors. The **polarity** control has no effect on the **record output** signal.

To adjust main output signal polarity:

Press and release the remote control **polarity button**.

- When **main output** signal polarity is non-inverted, pressing and releasing the **polarity button** inverts **main output** signal polarity. The front panel **polarity LED** lights red to indicate that **main output** signal polarity is inverted.
- When **main output** signal polarity is inverted, pressing and releasing the **polarity button** restores **main output** signal polarity to its non-inverted state.

4-3

Note

Experiment with **main output** signal polarity to determine the best sound for individual recordings. The sound difference between an inverted and non-inverted output signal ranges from subtle to inaudible, depending on microphone technique and other recording factors. In some cases, individual recordings will just sound better one way than the other.

Balance

Controls the left-to-right channel balance of the **main output** connectors, including the balanced (XLR) and single-ended (RCA) **main output** connectors. The **balance** control has no effect on the **record output** connectors.

The **balance** control facilitates precise adjustments in 0.1dB increments between 0.1dB and 20.0dB. When the balance offset exceeds 20.0dB, the N°326S mutes the channel outputting the lower signal level.

To adjust the left-to-right channel balance of the main output connectors:

1. Press and release the front panel or remote control **balance button** to open the **balance** control on the front panel display as shown to the left.

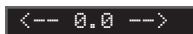

<-- 0.0 -->

The front panel **balance LED** lights red to indicate that the **balance** control is open.

2. Rotate the front panel **volume knob** or press the remote control **volume ± buttons** to make the desired adjustments.

- Rotate the **volume knob** clockwise or press the **volume + button** to decrease the output level of the left channel. The **balance** control appears as shown to the left to indicate that balance is offset in favor of the right channel.



0.1 -->

- Rotate the **volume knob** counterclockwise or press the **volume – button** to decrease the output level of the right channel. The **balance** control appears as shown to the left to indicate that balance is offset in favor of the left channel.



<-- 0.1

- Select the 0.0 setting to balance the output levels of the left and right channels, allowing both channels to output at the same level. The **balance** control appears as shown to the left to indicate that balance is centered between the left and right channels.



<-- 0.0 -->

3. When the desired adjustments have been made, press and release the **balance button** to close the **balance** control.
 - Otherwise, the **balance** control automatically closes a few seconds after the last command is received. If this occurs, the selected setting is automatically applied.
 - The front panel **balance LED** remains lit if the left-to-right channel balance of the **main output** connectors is offset.

Note

All N°326S volume controls, including master volume and **balance**, are deactivated when **SSP mode** (page 4-8) is activated.

Mono Playback

Sends mono (rather than stereo) signals to the **main output** connectors, whether those signals are using the balanced (XLR) or single-ended (RCA) **main output** connectors. The mono playback control has no effect on the **record output** connectors.

To toggle between mono and stereo playback:

Press and release the remote control **mono button**.

- During stereo playback, pressing and releasing the **mono button** activates the selected mode of mono playback. The front panel **mono LED** lights red to indicate that mono playback is activated.
- During mono playback, pressing and releasing the **mono button** deactivates mono playback and activates to stereo playback.

MODE

L + R, L ONLY, R ONLY, L – R

Determines the mode of mono playback that is activated when the remote control **mono button** is pressed. The factory-default **MODE** parameter setting is **L + R**.

- Selecting the **L + R** mono mode sends an equal combination of left and right-channel input signals to the left and right-channel **main output** connectors. Refer to *L + R Balance Control Tip* (next page) for additional information.
- Selecting the **L ONLY** mono mode sends the left-channel input signal to the left and right-channel **main output** connectors. The right-channel input signal is ignored.
- Selecting the **R ONLY** mono mode sends the right-channel input signal to the left and right-channel **main output** connectors. The left-channel input signal is ignored.
- Selecting the **L – R** mono mode sends the difference between the left and right-channel input signals to the left and right-channel **main output** connectors. Refer to *L – R Phono Alignment Tip* (page 4-7) for additional information.

4-5

MODE: L + R

To select the desired mono mode:

1. Press and hold the remote control **mono button** until the **MODE** parameter opens on the front panel display as shown to the left.
2. Press and release the **mono button** to cycle through all available **MODE** parameter settings.

L + R Balance Control Tip



- When the desired setting is selected, press and release the front panel or remote control **enter button** to close the **MODE** parameter.

Otherwise, the **MODE** parameter automatically closes a few seconds after the last command is received. If this occurs, the selected mono mode remains selected.

Precise left-to-right channel balance is critical to achieving an accurate soundstage. When **L + R** mono playback is activated, the **balance** control can be used to compensate for output level imbalances that occur after the N°326S in the signal chain, including those that result from asymmetrical loudspeaker placement and slight mismatches in loudspeaker sensitivity.

To use the L + R balance control:

- Press and hold the remote control **mono button** until the **MODE** parameter opens on the front panel display as shown to the left.
- Press and release the **mono button** to cycle through all available **MODE** parameter settings until the **L + R** mono mode is selected as shown to the left of step 1 (above).
- Press and release the front panel or remote control **enter button** to close the **MODE** parameter.

Otherwise, the **MODE** parameter automatically closes a few seconds after the last command is received. If this occurs, the selected mono mode remains selected.

- When the **MODE** parameter is closed, press and release the remote control **mono button** to activate **L + R** mono playback.
- Begin playback of the desired recording.

- Press and release the front panel or remote control **balance button** to open the **balance** control on the front panel display as shown to the left.



The front panel **balance** LED lights red to indicate that the **balance** control is open.

- Rotate the front panel **volume knob** or press the remote control **volume ± buttons** to center the image between the front left and right loudspeakers.

L – R Phono Alignment Tip

MODE: L + R

MODE: L – R

- When the desired adjustments have been made, press and release the **balance button** to close the **balance** control.

Otherwise, the **balance** control automatically closes a few seconds after the last command is received. If this occurs, the selected setting is automatically applied.

- Press and release the **mono button** to cancel L + R mono playback and return to stereo playback.

L – R mono playback simplifies the process of aligning phono cartridge azimuth.

To use L – R mono playback to align phono cartridge azimuth:

- Press and hold the remote control **mono button** until the **MODE** parameter opens on the front panel display as shown to the left.

- Press and release the **mono button** to cycle through all available **MODE** parameter settings until the L – R mono mode is selected as shown to the left.

- Press and release the front panel or remote control **enter button** to close the **MODE** parameter.

Otherwise, the **MODE** parameter automatically closes a few seconds after the last command is received. If this occurs, the selected setting remains selected.

- When the **MODE** parameter is closed, press and release the remote control **mono button** to activate L – R mono playback.

- Begin playback of the desired mono recording.

- Using the L – R output signal, adjust the associated phono cartridge azimuth to achieve minimal output signal.

Playing a mono recording when L – R mono playback is activated should result in silence (no output signal). Because phono cartridges differ, it is recommended to adjust azimuth to achieve minimal output signal.

- Press and release the **mono button** to cancel L – R mono playback and return to stereo playback.

SSP (Surround Sound Processor) Mode

This mode allows for complete integration between the N°326S and a multi-channel surround sound processor.

In the past, the difference between the number of channels in each component made integration difficult.

- Sending multi-channel processor output signals to a stereo preamplifier distorts calibrated processor output levels. Multi-channel processor volume controls adjust the relative volume level of all channels in unison. However, stereo preamplifier volume controls adjust the relative volume level of just the front left and right channels, leaving the center, surround, and subwoofer channels unaffected.

Different techniques have been used to compensate for this, including marking a calibrated point on the preamplifier volume control or using Dolby Pro Logic for volume level adjustments. But these techniques are crude, time consuming, and imprecise, resulting in an inconsistent performance at best.

- Sending stereo preamplifier output signals to a multi-channel processor interferes with some Dolby noise reduction processing. Processors that feature Dolby Pro Logic decoding sometimes also feature a form of Dolby noise reduction similar to the Dolby B noise reduction found in cassette decks. Designed to respond to input sources based on their strength, Dolby noise reduction requires input sources to be calibrated to Dolby standards. Variable preamplifier output signals cause Dolby noise reduction to mis-track and, in extreme cases, Dolby circuits to overload.

To avoid these problems, SSP mode allows input sources to pass through the N°326S without interference. When SSP mode is activated:

SSP LINE

- The front panel display appears as shown to the left, indicating that the N°326S is sending line-level input signals to the associated processor.
- The **Gain** parameter for the selected input is set to a fixed level of +0dB for inputs using balanced (XLR) connectors and +6dB for inputs using single-ended (RCA) connectors.
- All N°326S volume controls – including master volume, **balance**, and volume-related parameters – are deactivated to prevent the N°326s from distorting channel balance. As a result, the processor controls the relative volume level of all channels while maintaining its calibrated output levels.

To activate and use SSP mode:

1. Make sure the N°326S and all associated components are powered off and disconnected from electrical outlets.
2. Connect the output connectors on the surround sound source component to the input connectors on the surround sound processor.

For example, if this source component is a DVD player, connect the output connectors on the DVD player to the input connectors on the processor.
3. Connect the center, surround, and subwoofer output connectors on the processor to the appropriate input connectors on the power amplifier(s).
4. Connect the front left and right output connectors on the processor to the desired stereo **input connectors** on the N°326S.

For best performance, use balanced (XLR) connections whenever possible.

5. Connect the **main output** connectors on the N°326S to the appropriate input connectors on the power amplifier(s).

4-9

A balanced (XLR) connection between the N°326S and the associated power amplifier will offer the highest possible performance with the best protection against RF interference and other common mode noise.

CAUTION

BEFORE ACTIVATING SSP MODE, SET THE ASSOCIATED SURROUND SOUND PROCESSOR VOLUME CONTROL TO A REASONABLE LEVEL TO PREVENT SENDING DANGEROUS SIGNAL LEVELS TO THE LOUDSPEAKERS.

6. Using the N°326S, rotate the front panel **select knob** or press the remote control **select ± buttons** to select the input for which the stereo **input connector** selected in step 4 is assigned.

The front panel display indicates the name and volume level of the selected input.

Name=INPUT 1

Input 1 is used here as an example and may be substituted for whichever input was selected in step 4 (page 4-9).

Name=_____

Name=SSP

SAVING DATA

7. Press and hold the front panel or remote control **setup button** until the **Name** parameter for the selected input opens on the front panel display as shown to the left.

The front panel **setup LED** lights red to indicate that the **setup menu** is open.

8. Press the front panel or remote control **enter button** once to select the **Name** parameter and access the **custom names list**.

The current input name will blink on the front panel display as shown to the left to indicate that a new input name can be selected from the **custom names list**.

9. Rotate the front panel **volume knob** or press the remote control **volume ± buttons** to scroll through all custom input names until the **SSP** name appears on the front panel display as shown to the left.

10. Press the **enter button** to select the **SSP** name, which activates **SSP mode**.

The **SAVING DATA** message will appear on the front panel display as shown to the left to indicate that the **SSP** name is being saved.

5

Troubleshooting & Maintenance

Troubleshooting

Incorrect operation is sometimes mistaken for malfunction. If problems occur, refer to this section for troubleshooting information. If problems persist, contact Mark Levinson Customer Service at 781-280-0300 or www.marklevinson.com.

No Power

1. Examine the power cord to ensure that it is connected to both the **~ac mains** connector and a wall outlet.
2. Make sure the N°326S is powered on with the front panel **power button**.
3. Make sure the N°326S is not in standby. The front panel **standby LED** blinks red to indicate that the N°326S is in standby and lights red to indicate that the N°326S is not in standby.
4. Make sure **display intensity** has not been set to OFF (0%), deactivating the front panel display.
5. Examine the electrical circuit breaker to ensure that power is supplied to the wall outlet to which the N°326S is connected.

5-1

No Remote Control Operation

1. Eliminate obstructions between the remote control **IR transmitter** and the front panel display **IR receiver**.
2. Make sure the rear panel **ir input** connector is not being used.
3. Make sure the remote control is positioned within 17 feet (5m) of the front panel display **IR receiver**. If the N°326S is placed inside a glass cabinet, tinted glass will reduce the remote control range.
4. Make sure the remote control signal is being received at the front panel display **IR receiver** at a reasonable angle.
5. Make sure the front panel display **IR receiver** is not exposed to strong sunlight, halogen light, or fluorescent light. This can cause IR reception to become unreliable.
6. Replace the remote control batteries.

No IR Learning

1. Eliminate obstructions between the learning remote control and the left side of the front panel display.
2. Adjust the distance between the learning remote control and the left side of the front panel display.
3. Make sure the learning remote control and the left side of the front panel display are not exposed to strong sunlight, halogen light, or fluorescent light. This can cause IR reception to become unreliable.
4. Make sure the learning remote control is configured to learn commands.
5. Replace the learning remote control batteries.

No Main Output

1. Examine audio cables to ensure a solid connection between the N°326S and associated components.
2. Make sure master volume is set to an audible level.
3. Make sure mute is deactivated.
4. Make sure the **Offset** parameter for the selected input is not reducing master volume to an inaudible level.
5. Make sure the N°326S **main output** connectors are connected to an operational power amplifier, and that the associated power amplifier is connected to operational loudspeakers.
6. Make sure all associated components are powered on and connected to electrical outlets.
7. Make sure the associated component connected to the selected input is producing an input signal.

No Record Output

1. Make sure the **Rec.Out** parameter for the selected input has been used to assign the selected input for a **record output** connector.
2. Make sure the associated component connected to the selected input is producing an input signal.

Audible Hum

1. If a cable TV connection is present, disconnect the cable from the wall outlet. If this eliminates the humming sound, a ground loop isolation device is required. Contact an authorized Mark Levinson dealer for assistance.
2. Disconnect components one at a time to isolate the problem. Once the problem is identified, make sure the problematic component is properly grounded and connected to the same electrical circuit as the N°326S.

“Missing” Input	Make sure the Name parameter for the selected input has not been set to unused .
No Link Controls	<ol style="list-style-type: none">1. Make sure the slave chain includes Mark Levinson components that are compatible with the N°326S.2. Examine Link connections to ensure a solid connection between linked components.3. Make sure Link connections have been made using Link communication ports and supplied or constructed Link communication cables.4. Make sure constructed Link communication cables have been twisted 180° as shown in the illustration at the bottom of page 2-10 for a straight-through (pin 1-to-pin 1) connection.5. Examine the slave chain to ensure that connections meet all of the requirements listed in the table on page 2-11.6. Make sure Link controls have been enabled on the linked digital transport(s) linking menu, which allows activation and deactivation of individual Link controls. Refer to the appropriate digital transport owner’s manual for additional information.7. Make sure linked components have been powered on in the order specified in step 4 (page 2-12). Linked components must be powered on ONE AT A TIME in this order to ensure proper functioning of Link controls.
Erratic Behavior	<ol style="list-style-type: none">1. Power cycle the N°326S, waiting at least 10 seconds between powering the N°326S off and on.2. Restore factory-default settings.
If All Else Fails...	<ol style="list-style-type: none">1. Power cycle the N°326S, waiting at least 10 seconds between powering the N°326S off and on.2. Restore factory-default settings.3. Contact an authorized Mark Levinson dealer.4. Contact Mark Levinson Customer Service at 781-280-0300 or www.marklevinson.com.

Restoring Factory-Default Settings

Performing this procedure restores all parameters and user-defined controls to their factory-default settings. Before performing this procedure, it is recommended to record all custom settings on the *Installation Worksheet* (page A-4).

To restore factory-default settings:

1. Press and release the front panel **power button** to power off the N^o326S. It is also recommended to power off all associated components.
2. Press and hold the front panel **setup** and **display intensity buttons**.
3. Still holding the **setup** and **display intensity buttons**, press and release the **power button** to power on the N^o326S.

CLEAR SETUP?

The CLEAR SETUP? message will appear on the front panel display as shown to the left.

4. Choose one of the following:
 - To restore factory-default settings, continue holding the **setup** and **display intensity buttons** for about 10 seconds. The **FACTORY SETTINGS RESTORED** message will blink on the front panel display as shown below when factory-default settings have been restored.



- To cancel restoration of factory-default settings, release the **setup** and **display intensity buttons**. The **CLEAR** and **CANCELLED** messages will blink on the front panel display as shown below to indicate that restoration of factory default settings has been cancelled.



5. Power on all associated components that were powered off in step 1.

Care & Maintenance

The N°326S requires routine care and maintenance to ensure optimal performance. The bulleted items below indicate maintenance procedures that should be performed on a regular basis.

Note

Failure to perform the maintenance procedures included in this section may void the manufacturer's warranty and/or standard repair policies.

- Use a feather duster or a low-pressure blower to remove dust from the N°326S exterior surface.
- Use a soft, lint-free cloth to remove dirt and fingerprints from the N°326S exterior surface. Do not use a cloth made with steel wool or metal polish. If needed, this cloth can be dampened with isopropyl alcohol. Do not dampen the cloth with Benzene, acetone-based cleaners, and other commercial cleaners. Wipe the N°326S exterior surface in the same direction as the grain of the brushed aluminum.

5-5

CAUTION

DO NOT APPLY LIQUID DIRECTLY TO THE N°326S EXTERIOR SURFACE. DOING SO MAY DAMAGE ELECTRICAL COMPONENTS.

- Replace the remote control batteries as needed. Refer to *Remote Control Batteries* (page 1-6) for additional information.
- Refer to *Installation Considerations* (page 1-4) for information about preventive maintenance.

A

Appendix

Specifications

Unless otherwise specified, these specifications indicate nominal values measured over a 20Hz to 20kHz bandwidth through balanced (XLR) connections.

Power Consumption	<ul style="list-style-type: none">▪ 50W maximum
Operating Voltage	<ul style="list-style-type: none">▪ 100, 120, 220, or 230V AC power at 50 or 60Hz (preset)
Connector Complement	<ul style="list-style-type: none">▪ 3 balanced (female XLR) stereo inputs▪ 4 single-ended (Mark Levinson-RCA) stereo inputs▪ 1 balanced (male XLR) stereo main output▪ 1 single-ended (Mark Levinson-RCA) stereo main output▪ 2 single-ended (Mark Levinson-RCA) stereo record outputs▪ 2 8-pin RJ-45 connectors for Link communication▪ 1 6-pin modular RJ-11 connector for RS-232 communication▪ 1 3.5mm mini-jack for trigger output▪ 1 3.5mm mini-jack for ir input▪ 1 phono ground terminal▪ 1 IEC-standard ~ac mains connector
Gain	<ul style="list-style-type: none">▪ 0, 6, 12, or 18dB (line-level stage)
Volume Control Range	<ul style="list-style-type: none">▪ 80.0dB (maximum)
Gain Resolution	<ul style="list-style-type: none">▪ 1.0dB increments up to 23.0dB on front panel display (-57dB)▪ 0.1dB increments above 23.0dB on front panel display (-57dB)

A-1

Specifications are subject to change without notice.

Input Overload	Gain Setting	XLR Connectors	RCA Connectors
	+18dB	1.6V	0.8V
	+12dB	3.3V	1.6V
	+6dB	6.6V	3.3V
	0dB	13.2V	6.6V
Input Impedance	▪ 100k		
Output Impedance	▪ <50Ω		
THD + N	▪ <0.001%		
Crosstalk	▪ < -94dBV, 20Hz to 20KHz (input terminated)		
Residual Noise	▪ 20Hz to 20kHz (input terminated < -94dBV)		
Frequency Response	▪ 10 to 40kHz, ±0.2 dB		
Weight	▪ 30 pounds (14kg)		

Specifications are subject to change without notice.

Dimensions

Front View

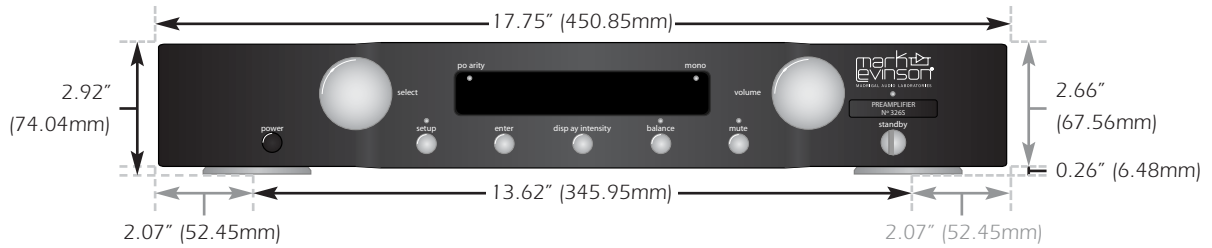

Top View

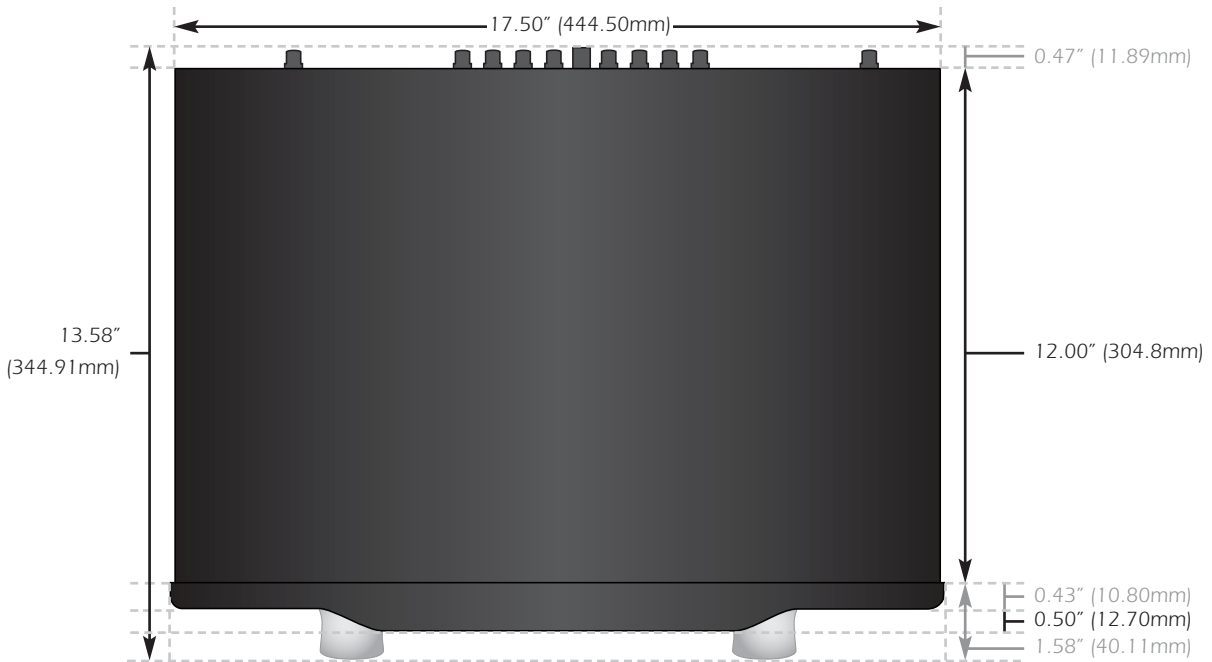

A-3

Specifications are subject to change without notice.

Installation Worksheet

Set Inputs	Name	Gain	Offset	Rec.Out
Input 1				
Input 2				
Input 3				
Input 4				
Input 5				
Input 6				
Input 7				
Setup Menu Parameters		Control/Mode Settings		
Mute		Polarity		
MaxVol		Intensity		
Trig.		Balance		
Sw		Mono Playback		

A-4

Set Inputs	Name	Gain	Offset	Rec.Out
Input 1				
Input 2				
Input 3				
Input 4				
Input 5				
Input 6				
Input 7				
Setup Menu Parameters		Control/Mode Settings		
Mute		Polarity		
MaxVol		Intensity		
Trig.		Balance		
Sw		Mono Playback		

Declaration of Conformity

Application of Council Directive(s):

89/336/EEC and 73/23/EEC, as amended.

Standard(s) to which Conformity is Declared:

EN 55013 : 2003
EN 55020 : 2002
EN 55022 : 1998
EN 61000-3-2 : 2000
EN 61000-3-3 : 2002
EN 60065 : 1998

Manufacturer: Harman Specialty Group
3 Oak Park
Bedford, MA 01730-1413 USA

A-5

The equipment identified here conforms to the Directive(s) and Standard(s) specified above.

Type of Equipment: Preamplifier
Model: Mark Levinson No. 326S
Date: June 2004

Harman Specialty Group
Vice President of Engineering
3 Oak Park
Bedford, MA 01730-1413 USA
Tel: 781-280-0300
Fax: 781-280-0490
www.marklevinson.com

SYMBOLS

- ⚠, iv, IFC
- ⚠, iv, IFC
- CAUTION**, iv, 1-6, 1-7, 1-9, 2-5, 2-10, 3-5, 3-8, 4-9, 5-5, IFC
- ⚠, iv
- Note**, iv, 1-5, 1-8, 1-9, 2-1, 2-2, 2-3, 2-4, 2-5, 2-6, 2-7, 2-8, 2-9, 2-11, 2-12, 2-15, 2-16, 2-17, 2-18, 2-19, 3-2, 3-4, 3-7, 3-8, 3-10, 4-1, 4-2, 4-3, 4-4, 5-5
- WARNING**, iv, 1-6, IFC

A

- ~ac mains connector, 1-6, 1-7, 1-8, 2-1, 2-2, 2-5, 2-16, 5-1, A-1
- adjusting parameter settings, 3-3
- audio circuits, 1-1, 1-2, 1-3
- Arlon[®], 1-1, 1-3
- AUX input name, 3-5
- auxiliary components, 3-5
- azimuth alignment, phono cartridges, 4-7

B

- balance, 1-4, 2-3, 2-4, 2-7, 2-17, 2-18, 3-8, 3-9, 4-3 to 4-4, 4-6, 4-7, 4-8, A-4
- balance button, 2-4, 2-18, 3-9, 4-4, 4-6, 4-7
- BALANCE KEY IR command, 3-9
- balance LED, 2-4, 2-18, 4-4, 4-6
- balanced circuits, 1-2
- balanced connectors, 1-2, 1-3, 1-9, 2-6, 4-3, 4-5, 4-8, 4-9, A-1
- balanced conversion, input signals, 1-2, 1-4
- batteries, remote control, 1-6 to 1-7 (*ill.*), 2-15, 5-1, 5-5

C

- CANCELLED message, 5-4
- care & maintenance, 5-5
- CASS input name, 3-5
- cassette decks, 3-5, 4-8
- CAUTION**, iv, 1-6, 1-7, 1-9, 2-5, 2-10, 3-5, 3-8, 4-9, 5-5, IFC
- CD input name, 3-5
- CD players, 1-9, 3-5
- CD processors, 2-9, 2-11
- CD recorders, 2-7, 3-5
- CD transports, 2-9
- CD-R input name, 3-5
- ⚠, iv
- channel balance, 2-4, 2-18, 4-3, 4-4, 4-6
- channel separation, 1-2, 1-3, 2-5
- character list, 3-4, 3-5, 3-6 (*ill.*), 3-7
- CLEAR message, 5-4
- CLEAR SETUP? message, 5-4
- communication circuits, 1-2, 1-3
- compatibility, linking, 2-9, 2-11
- connectors
 - ~ac mains, 1-6, 1-7, 1-8, 2-1, 2-2, 2-5, 2-16, 5-1, A-1
 - balanced, 1-2, 1-3, 1-9, 2-6, 4-3, 4-5, 4-8, 4-9, A-1
 - crosstalk, A-2
 - input, 1-2, 1-3, 1-9, 1-10, 2-6, 3-4, 3-7, 3-9, 4-9, A-1
 - ir input, 1-2, 1-4, 1-6, 2-2, 2-8 (*ill.*), 2-15, 2-16, 5-1, A-1
 - Link2, 1-2, 1-4, 2-7, 2-9, 2-11, 3-10, A-1
 - main output, 1-2, 1-3, 1-8, 1-9, 2-2, 2-4, 2-6, 2-18, 3-8, 4-3, 4-4, 4-5, 4-9, 5-2, A-1
 - mini-jack, 2-8, A-1
 - phono ground, 2-8, A-1
 - phono input, 2-6
- connectors

- RCA, 1-2, 1-3, 1-9, 2-6, 2-7, 4-3, 4-5, 4-8, A-1, A-2
- record output, 1-2, 1-3, 2-3, 2-7, 2-17, 2-18, 3-3, 3-8, 4-3, 4-5, 5-2, A-1
- RJ-11, 2-8, 2-10, A-1
- RJ-45, 2-7, 2-10, A-1
- RS-232, 1-2, 1-4, 2-8, 3-11, A-1
- slave in, 1-2, 1-4, 2-7, 2-9, 2-11, 3-10, A-1
- single-ended, 1-2, 1-3, 1-4, 1-9, 2-6, 2-7, 4-3, 4-5, 4-8, A-1
- specifications, A-1
- trigger output, 1-2, 1-4, 2-8, 3-11, A-1
- XLR, 1-2, 1-3, 1-9, 2-6 (*ill.*), 4-3, 4-5, 4-8, 4-9, A-1, A-2
- constructing Link communication cables, 2-10 (*ill.*)
- continuous operation, N^o320S, 1-8, 4-1
- control circuits, 1-1, 1-3
- creating a slave chain, 2-9, 2-10 to 2-13 (*ill.*)
- crosstalk, A-2
- custom input names, 3-4, 3-5, 3-6 4-10
- custom names list, 3-4 to 3-5 (*ill.*), 3-6, 4-10

D

- D/A converters, 3-5
- DAC input name, 3-5
- DAT input name, 3-5
- digital audio processors, 2-7, 2-9, 2-10, 2-11, 2-12, 2-13, 2-14, 3-5
- digital transports, 2-7, 2-9, 2-10, 2-11, 2-12, 2-13, 2-14, 2-15, 3-5, 3-10, 5-3
- digital-to-analog converters, *see* D/A converters
- dimensions, N^o326S, A-3

D (continued)

display button, 2-18, 3-9, 4-3
 DISPLAY DIM IR command, 3-9
 DISPLAY FULL IR command, 3-9
 DISPLAY HALF IR command, 3-9
 display intensity, 1-4, 2-4, 2-7, 2-9, 2-13, 2-14, 2-18, 3-9, 4-2 to 4-3, 5-1, A-4
 display intensity button, 2-4, 4-3, 5-4
 display intensity link, 2-7, 2-9, 2-13, 2-14
 DISPLAY OFF IR command, 3-9
 documentation conventions, iv
 Dolby circuits, 4-8
 DVD input name, 3-4, 3-5
 DVD players, 3-4, 3-5, 4-9

E

enter button, 2-3, 2-17, 3-2, 3-3, 3-6, 3-9, 3-10, 4-2, 4-6, 4-7, 4-10
 ENTER KEY IR command, 3-9
 EXIT BALANCE IR command, 3-9
 EXIT STANDBY IR command, 3-9

F

factory-default settings, restoring, 3-7, 5-3, 5-4
 FACTORY SETTINGS RESTORED message, 5-4
 FCC notice, i
 frequency response, A-2
 front panel display, 1-4, 1-6, 2-2, 2-4, 2-14, 2-15, 2-16, 2-18, 3-1, 3-8, 3-9, 4-2, 4-3, 5-1, 5-2
 front panel overview, 2-1 (*ill.*) to 2-4

G

gain levels, input, 1-2, 3-3, 3-7, 4-8
 Gain parameter, 3-3, 3-4, 3-7, 4-8,

A-2, A-4

gain resolution, A-1
 gain specification, A-1
 GO BALANCE IR command, 3-9
 GO INPUT 1-7 IR commands, 3-9
 GO MUTE IR command, 3-9
 GO STANDBY IR command, 3-9
 GO UNMUTE IR command, 3-9

H

HDCD link, 2-14
 highlights, N^o326S, 1-3 to 1-4

I

impedance, A-2
 infrared signals, 2-8, 2-16, 3-8, 3-9, 3-10
 initialization sequence, 1-8, 2-1, 2-12, 4-1
 INPUT 1-7 input names, 3-5, 3-6
 input connectors, 1-2, 1-3, 1-9, 1-10, 2-6, 3-4, 3-7, 3-9, 4-9, A-1
 input impedance, A-2
 input selection link, 2-7, 2-9, 2-13, 2-14

inputs

activated, 2-2, 2-17, 3-8
 assigning components, 2-13, 2-14, 3-4, 3-5
 assigning record outputs, 1-2, 2-7, 3-3, 3-8, 5-2
 deactivated, 1-2, 1-3, 2-2, 2-17, 3-4
 gain levels, 1-2, 3-3, 3-7, 4-8
 “missing”, 5-3

inputs**names**





character list, 3-4, 3-5, 3-6 (*ill.*), 3-7
 custom, 3-4, 3-5, 3-6 4-10
 custom names list, 2-14, 3-4 to 3-5 (*ill.*), 3-6, 4-10
 factory-default, 1-7, 1-10, 3-4, 3-5, 3-6, 3-7

scrolling, 2-2, 2-14, 2-17, 3-5
 selected, the, 1-2, 1-10, 2-2, 2-3, 2-14, 2-17, 3-4, 3-5, 3-6, 3-7, 3-8, 4-8, 4-9, 4-10, 5-2, 5-3
 selecting, 1-2, 1-10, 2-2, 2-7, 2-9, 2-12, 2-13, 2-14, 2-17, 3-3, 3-4, 3-6, 3-9, 4-9
 specifications, A-1
 volume levels, 1-2, 1-10, 2-2, 2-3, 2-14, 2-17, 3-3, 3-4, 3-6, 3-7, 4-9
 installation considerations, N^o326S, 1-4 to 1-7
 installation worksheet, A-4
 INTENSITY KEY IR command, 3-9
 ir input connector, 1-2, 1-4, 1-6, 2-2, 2-8 (*ill.*), 2-15, 2-16, 5-1, A-1
 IR learning
 commands, 3-8, 3-9, 3-10
 connections, 2-15, 3-10
 learning remote controls, 3-8, 3-9, 3-10, 5-2
 reception, 2-15, 3-9, 5-1, 5-2
 troubleshooting, 5-2
 IR receiver, 1-6, 2-2, 2-15, 2-16, 5-1
 IR transmitter, 1-6, 2-2, 2-15, 2-16, 5-1

L

L + R mono mode, 4-5, 4-6, 4-7
 L – R mono mode, 4-5, 4-7
 L ONLY mono mode, 4-5
 laser disc players, 3-5
 LD input name, 3-5
 learning remote controls, 3-8, 3-9, 3-10, 5-2
 LEDs, front panel
 balance, 2-4, 2-18, 4-4, 4-6
 mono, 2-2, 2-18, 4-5
 mute, 2-4, 2-18
 polarity, 2-2, 2-18, 4-3
 setup, 2-3, 2-16, 3-2, 3-4, 3-6, 4-10
 standby, 2-2, 2-4, 2-12, 2-16, 2-18, 4-1, 4-2, 4-3, 5-1

L (continued)**Link**

- communication cables, 1-5, 2-9, 2-10 (*constructing*), 5-3
- communication ports**
 -  2-7, 2-9, 2-11, 3-10, A-1
 -  control, 2-11
 -  input, 2-11
 - master, 2-9, 2-11
 - names, 2-11
 - N°326S, 1-2, 1-4, 2-7, 2-9, 2-10, 2-11, 3-10, A-1
 - slave in, 2-7, 2-9, 2-11
 - slave out, 2-9, 2-11
- compatibility, 2-9, 2-11
- connections, 2-9 to 2-10 (*making*), 2-11, 2-12, 2-15, 3-10, 5-3
- controls, 2-7, 2-9, 2-13 to 2-14, 3-4, 3-5, 5-3
- slave chains, 2-9, 2-10 to 2-13 (*ill.*)
- troubleshooting, 5-3
-  communication port, 2-7, 2-9, 2-11, 3-10, A-1
- linked components**, 2-7, 2-10, 2-11, 2-12, 2-13, 2-14, 3-4, 3-5, 5-3
- linking**, 2-9 to 2-15
- loudspeakers**, 1-5, 2-3, 3-5, 3-8, 4-6, 4-9, 5-2

M

- main output connectors**, 1-2, 1-3, 1-8, 1-9, 2-2, 2-4, 2-6, 2-18, 3-8, 4-3, 4-4, 4-5, 4-9, 5-2, A-1
- maintenance**, N°326S, 5-5
- making connections**, 1-9, 2-5, 2-9, 2-10, 2-12
- master volume**, 1-2, 1-3, 2-3, 2-4, 2-7, 2-14, 2-15, 2-17, 2-18, 2-19, 3-7, 3-8, 3-10, 3-11, 4-4, 4-8, 5-2
- MaxVol** parameter, 2-3, 2-17, 3-11, A-4
- MD** input name, 3-5
- mini-disc players**, 3-5
- mini-jack connectors**, 2-8, A-1
- “missing” inputs**, 5-3
- MODE** parameter, 4-5, 4-6, 4-7

modes

- mono modes, 2-18, 4-5, 4-6, 4-7
- normal operating mode, 2-1, 2-2, 2-3, 2-15, 2-16
- SSP mode, 1-3, 2-3, 2-17, 3-4, 3-5, 4-4, 4-8 to 4-10
- see also surround sound processors*
- mono button**, 2-2, 2-18, 3-9, 4-5, 4-6, 4-7
- MONO KEY IR** command, 3-9
- mono LED**, 2-2, 2-18, 4-5
- mono modes**, 2-18, 4-5, 4-6, 4-7
- mono playback**, 1-4, 2-2, 2-18, 4-5 to 4-7, A-4
- mute button**, 2-4, 2-18 to 2-19, 3-9, 3-11
- MUTE KEY IR** command, 3-9
- mute level**, 2-4, 2-18, 2-19, 3-11
- mute LED**, 2-4, 2-18
- Mute** parameter, 2-4, 2-19, 3-11, A-4

N

- Name** parameter, 2-2, 2-7, 2-17, 3-3, 3-4 to 3-7, 4-10, 5-3, A-4
- navigating the setup menu**, 3-1 to 3-3 (*ill.*)
- N°30, 2-9, 2-14, 3-5
- N°30.5, 2-9, 2-14, 3-5
- N°30.6, 2-9, 2-14, 3-5
- N°31, 2-9, 2-15, 2-14, 3-10
- N°31.5, 2-9, 2-15, 2-14, 3-10
- N°32, 1-1
- N°326S**
 - care & maintenance, 5-5
 - dimensions, A-3
 - highlights, 1-3 to 1-4
 - installation considerations, 1-4 to 1-7
 - obtaining service, IBC
 - operating voltage, 1-7, 2-1, 2-5, A-1
 - phono modules, 1-1, 1-4, 2-6
 - power requirements, 1-7 to 1-8
 - product registration, 1-4, 1-5, 2-8
 - return authorization, IBC
 - serial number, 2-8, IBC

- shipping, 1-4, IBC
- special design features, 1-1 to 1-4
- unpacking, 1-4 to 1-5
- warranty, 1-4, 1-5, 5-5, IBC
- weight, A-2
- N° 35, 3-5
- N° 36, 2-9, 3-5
- N° 360, 2-9, 3-5
- N° 360S, 2-9, 2-11, 2-13, 3-4, 3-5
- N° 36S, 2-9, 3-5
- N° 37, 2-9, 2-11, 2-13, 2-14, 2-15, 3-10
- N° 39, 2-9, 2-11, 2-15, 3-5, 3-10
- N° 390S, 2-9, 2-11, 2-13, 2-15, 3-5, 3-10
- N° 431, 2-13
- N° 432, 2-11, 2-13
- NO CHANGE** message, 3-2
- normal operating mode**, 2-1, 2-2, 2-3, 2-15, 2-16
- Note**, iv, 1-5, 1-8, 1-9, 2-1, 2-2, 2-3, 2-4, 2-5, 2-6, 2-7, 2-8, 2-9, 2-11, 2-12, 2-15, 2-16, 2-17, 2-18, 2-19, 3-2, 3-4, 3-7, 3-8, 3-10, 4-1, 4-2, 4-3, 4-4, 5-5

O

- obtaining service**, IBC
- Offset** parameter, 2-3, 2-17, 3-3, 3-4, 3-7, 5-2, A-4
- operating voltage**, 1-7, 2-1, 2-5, A-1
- operation considerations, remote control**, 1-6, 2-15 to 2-16
- output impedance**, A-2
- output level imbalances**, 4-6
- overload**, input, A-2

P

- parameters, adjusting**, 3-3
- phono cartridges**, 2-8, 4-7
 - azimuth alignment, 4-7
- phono ground** connector, 2-8, A-1
- phono input** connector, 2-6
- phono modules**, N°326S, 1-1, 1-4, 2-6
- placement**, N°326S, 1-5 to 1-6

P (continued)**playback**

mono, 1-4, 2-2, 2-18, 4-5 to 4-7, A-4

stereo, 1-4, 4-5, 4-7

playback link, 2-7, 2-9, 2-13, 2-14

polarity, 1-4, 2-2, 2-18, 3-8, A-4

polarity button, 2-2, 2-18, 3-9, 4-3

POLARITY KEY IR command, 3-9

polarity LED, 2-2, 2-18, 4-3

ports, *see connectors*

power amplifiers, 1-2, 1-5, 1-9, 1-10, 2-6, 2-7, 2-9, 2-10, 2-11, 2-12, 2-13, 2-14, 4-9, 5-2

power button, 1-6, 1-8, 2-1, 4-1, 5-1, 5-4

power consumption, N^o326S, A-1

power cord, 1-5, 1-6, 1-7, 1-8, 2-1, 2-5, 5-1

power failures, 1-8, 2-13, 5-1

power requirements, N^o326S, 1-7 to 1-8

power supplies, 1-1, 1-2, 1-3

power transformers, 1-1

product registration, 1-4, 1-5, 2-8

Q

quick start guide, N^o326S, 1-8 to 1-10

R

R ONLY mono mode, 4-5, 4-7

RCA connectors, 1-2, 1-3, 1-9, 2-6, 2-7, 4-3, 4-5, 4-8, A-1, A-2

rear panel overview, 2-5 to 2-8 (*ill.*)

Rec.Out parameter, 2-7, 3-3, 3-4, 3-8, 5-2, A-4

recording, 2-7, 2-14, 3-8, 4-3

record link, 2-7, 2-9, 2-13, 2-14

record output connectors, 1-2, 1-3, 2-3, 2-7, 2-17, 2-18, 3-3, 3-8, 4-3, 4-5, 5-2, A-1

reel-to-reel players, 3-5

remote control

batteries, 1-6 to 1-7 (*ill.*), 2-15, 5-1, 5-5

command overview, 2-16 to 2-19 (*ill.*)

operation considerations, 1-6, 2-15 to 2-16

overview, 2-15 to 2-19 (*ill.*)

troubleshooting, 5-1

residual noise, A-2

RESTORING message, 3-2

return authorization, IBC

RF interference, 1-6, 1-9, 2-6, 2-8, 4-9

RJ-11 connectors, 2-8, 2-10, A-1

RJ-45 connectors, 2-7, 2-10, A-1

RS-232 communication port, 1-2, 1-4, 2-8, 3-11, A-1

RtoR input name, 3-5

S

SACD input name, 3-5

SACD players, 3-5

safety instructions, IFC

SAT input name, 3-5

satellite receivers, 3-5

SAVING DATA message, 3-2, 3-6, 3-7, 4-10

scrolling inputs, 2-2, 2-14, 2-17, 3-5

select ± buttons, 1-10, 2-17, 3-3, 3-4, 3-5, 3-6, 3-9, 3-10, 4-9

select knob, 1-2, 1-10, 2-2, 3-3, 3-4, 3-5, 3-6, 3-10, 4-9

SELECT NEXT IR command, 3-9

SELECT PREV IR command, 3-9

selecting inputs, 1-2, 1-10, 2-2, 2-7, 2-9, 2-12, 2-13, 2-14, 2-17, 3-3, 3-4, 3-6, 3-9, 4-9

SENDING --> message, 3-10

serial number, 2-8, IBC

service, obtaining, IBC

Set Inputs menu, 1-2, 1-4, 3-3 to 3-8 (*ill.*), 3-4 (*shortcut*) A-4

setup button, 1-2, 2-3, 2-16, 3-1, 3-2, 3-4, 3-6, 3-9, 4-10, 5-4

SETUP KEY IR command, 3-9

setup LED, 2-3, 2-16, 3-2, 3-4, 3-6, 4-10

Setup menu, 2-3, 2-16, 2-17, 3-1 to 3-3 (*navigating the*), 3-2, 3-4, 3-6, 3-10, 3-11, 4-10, A-4

shipping the N^o326S, 1-4, IBC

shortcut, **Set Inputs** menu, 3-4

single-ended connectors, 1-2, 1-3, 1-4, 1-9, 2-6, 2-7, 4-3, 4-5, 4-8, A-1

slave in communication port, 2-7, 2-9, 2-11, 3-10, A-1

slave chains, 2-9, 2-10 to 2-13 (*ill.*)

SLEEP parameter, 4-1 to 4-2

sleep timer, 1-4, 4-1 to 4-2

special design features, N^o326S, , 1-1 to 1-4

specifications, A-1 to A-3

SSP input name, 3-5, 4-10

see also surround sound processors

SSP mode, 1-3, 2-3, 2-17, 3-4, 3-5, 4-4, 4-8 to 4-10

see also surround sound processors

standby, 1-4, 1-8, 2-1, 2-2, 2-7, 2-9, 2-12, 2-13, 2-14, 2-16, 3-9, 3-11, 4-1 to 4-2, 5-1

standby button, 1-8, 2-2, 2-16, 3-9, 3-11, 4-1, 4-2

standby LED, 2-2, 2-4, 2-12, 2-16, 2-18, 4-1, 4-2, 4-3, 5-1

standby link, 2-7, 2-9, 2-13, 2-14

STANDBY KEY IR command, 3-9

stereo playback, 1-4, 4-5, 4-7

surround sound processors, 1-3, 4-8 to 4-10

see also SSP mode

Sw parameter, 3-11, A-4

T

table of contents, ii

tape decks, 2-7, 3-5

TAPE input name, 3-5

Teach IR menu, 3-8 to 3-10 (*ill.*)

THD + Noise, A-2

Trig. parameter, 2-8, 3-11, A-4

trigger output connector, 1-2, 1-4, 2-8, 3-11, A-1

troubleshooting, 5-1 to 5-3

TUNER input name, 3-5

tuners, 3-5

U

unpacking, N^o326S, 1-4 to 1-5

unused input name, 1-2, 1-3, 2-2, 2-17, 3-5, 5-3

V

VCR input name, 3-5

VCRs, 3-5, 3-8

volume \pm buttons, 2-17, 2-19, 3-2,
3-3, 3-6, 3-9, 3-10, 4-4, 4-6, 4-10

volume attenuators, 1-1, 1-2, 1-3

volume control range, A-1

VOLUME DOWN IR command, 3-9

volume knob, 2-3, 2-4, 3-2, 3-3,
3-6, 3-10, 4-4, 4-6, 4-10

VOLUME UP IR command, 3-9, 3-
10

W

warm-up & break-in period,
N°326S, 1-7 to 1-8

WARNING, iv, 1-6, IFC

warranty, N°326S, i, 1-4, 1-5, 2-8,
2-10, 5-5, IBC

weight, N°326S, A-2

X

XLR connectors, 1-2, 1-3, 1-9, 2-6
(*ill.*), 4-3, 4-5, 4-8, 4-9, A-1, A-2

Obtaining Service

We take great pride in selling Mark Levinson products through a network of well-trained dealers who are dedicated to customer satisfaction. These professionals are ideally suited to design, install, and, if the need arises, facilitate the service of high-performance electronic home entertainment systems.

Customer Service assists authorized Mark Levinson dealers in solving problems effectively. When purchasing Mark Levinson products, customers make a substantial investment in audio/video equipment of exceptional quality. In the event that service is needed, Customer Service intends to provide assistance that matches that investment.

If this Mark Levinson product requires service, contact an authorized Mark Levinson dealer for assistance. The dealer will contact Customer Service to determine the best way to rectify the situation and, if needed, to obtain return authorization in the event that the product must be returned to the factory for repair. Alternatively, customers may contact Customer Service directly to obtain return authorization. However, return authorization must be obtained before any product is shipped to the factory. Products returned without prior authorization will be refused.

When obtaining return authorization, please be prepared to provide the model, serial number, and a complete, explicit description of the problem. A copy of the original, dated Bill of Sale must be included to confirm warranty status.

Please always retain the original packing materials. This product should be properly packaged (in its original packing materials whenever possible) and the proper return authorization must be on the outer carton for easy identification. Improper packaging may lead to unnecessary freight damage that is not covered by either the freight carrier or the warranty.



3 Oak Park, Bedford, MA, 01730-1413 USA | Telephone: 781-280-0300 | Fax: 781-280-0490 | www.marklevinson.com

Customer Service Telephone: 781-280-0300 | Sales Fax: 781-280-0495 | Service Fax: 781-280-0499

Product Shipments: 16 Progress Road, Billerica, MA 01821-5730 USA

Part No. 070-16658 | Rev 0 | 06/04