

MAC 1500 STEREO RECEIVER

WARRANTY STATION

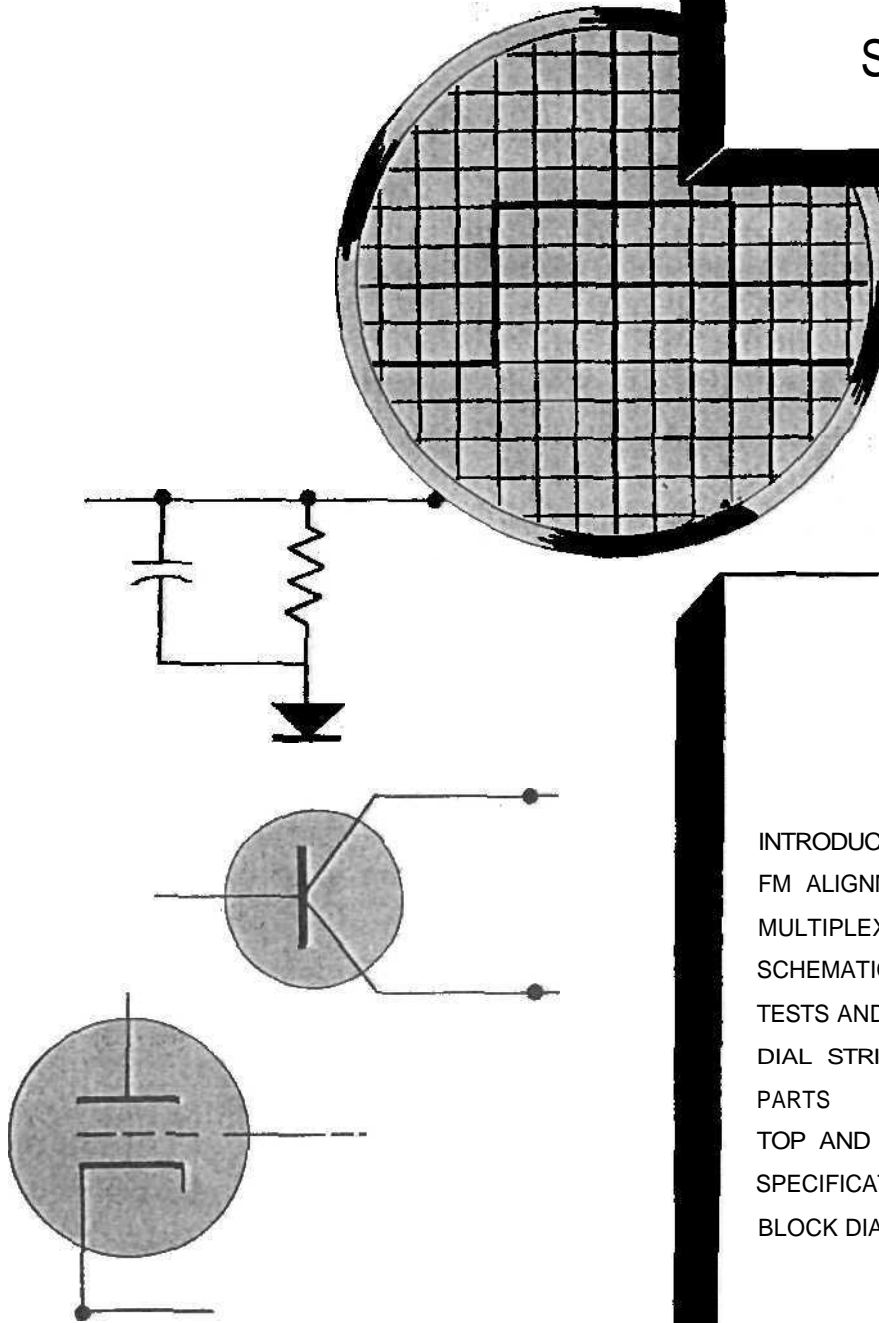

SERVICE MANUAL



CONTENTS

INTRODUCTION	1
FM ALIGNMENT CHART	2-3
MULTIPLEX DECODER ALIGNMENT CHART	4-5
SCHEMATIC	6-7
TESTS AND ADJUSTMENTS	8
DIAL STRINGING	8
PARTS LIST	9-14
TOP AND BOTTOM VIEWS	15
SPECIFICATIONS	16
BLOCK DIAGRAM	16

McINTOSH AUDIO COMPANY

2 Chambers St., Binghamton, N.Y. 13903

MAC1500

MAC 1500 STEREO RECEIVER

INTRODUCTION

All McIntosh tuners are carefully aligned and tested at the factory using the finest available test equipment. All McIntosh tuners will meet their published specifications when shipped from the factory.

After extensive operation, especially when tubes have been replaced, it may be desirable to realign the timer circuits for best performance. This manual gives complete information on the circuit realignment procedure for the MAC 1500 receiver.

The test equipment listed below (or its equivalent) is necessary to properly align a MAC 1500. The accuracy of the alignment will be directly related to the accuracy and calibration of the test equipment used.

FM Signal Generator (Measurements 210A or equivalent)

VTVM

Multiplex Generator (RCA WR51A or equivalent)

10.7 MC Generator (Preferably crystal controlled)

Oscilloscope (Hewlett-Packard 120B or equivalent)

Harmonic Distortion Analyzer (Hewlett-Packard 330B or equivalent)

If the necessary test equipment is not available, alignment should not be attempted. You may contact the McIntosh Customer Service Department for additional information.

Customer **Service**
McIntosh Laboratory, Inc.
2 Chambers **Street**
Binghamton, **New York**

Our telephone **number is 723-5491**

The direct dial area code is 607

STEPS	TUNER DIAL SETTING	SIGNAL GENERATOR			INDICATOR	
		FREQ.	COUPLING	MODULATION	TYPE	CONNECTED TO
1	Point of no interference and no signal	10.7MC	Through external .01 MFD capacitor to mixer grid (pin 4 or 6DS4, V2)	CW	VTVM	TP#1
2	SAME	SAME	SAME	SAME	SAME	Pin 1 of T4
3	SAME	SAME	SAME	SAME	SAME	TP#2
4	105MC	105MC	300 ohm antenna terminals with matching network*	400 cycles 75KC deviation (100% modulation)	VTVM connected to TP#2 and scope connected to L or R tape output	
5	90MC	90MC	SAME	SAME	SAME	
6	105MC	105MC	SAME	SAME	SAME	
7	90MC	90MC	SAME	SAME	SAME	
8	90MC	90MC	SAME	SAME	VTVM connected to TP#2; scope and distortion analyzer connected to L or R tape output	
9	105MC and 90MC	105MC and 90MC	SAME	50 cps 150KC deviation Approx. 5 microvolts at antenna terminals	See note ** at bottom of page	
10	90MC	90MC	SAME	400 cycles 75KC deviation (100% modulation)	Scope connected to L or R tape output	
11	90MC	90MC	SAME	SAME	VTVM connected to TP#1; scope and distortion analyzer connected to L or R tape output	

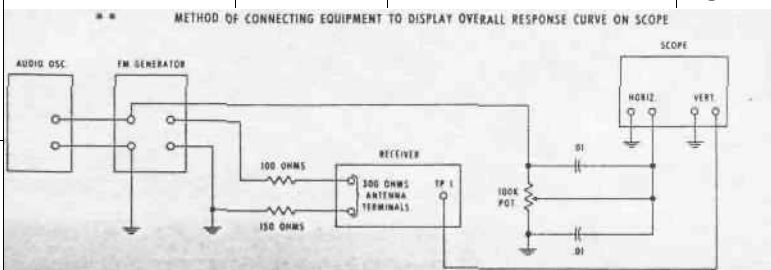

FM ALIGNMENT

ADJUST	TEST LIMITS	REMARKS
		Before making any adjustments, set the controls as follows: a) Input selector switch to FM mono, b) Volume control maximum CCW. c) Muting pot maximum CW. d) Muting OUT. e) Stereo light adjust maximum CW.
Top (secondary) and bottom (primary) of T1, T2, T3	Maximum possible negative voltage	Shunt to ground the winding not being adjusted. Do this with a .01 MFD capacitor in series with a 1K resistor. Attenuate signal generator until output voltage at TP#1 is less than 1.5 volts with one IF transformer winding shunted. IF transformers have terminal #1 marked with a green dot and are numbered clockwise.
Primary and secondary of T4	Maximum possible negative voltage (should be 20 to 30 volts)	Muting pot. MUST be maximum CW.
Secondary (top) of T-5	Adjust for 0 volts	The primary (bottom) of T-5 should be adjusted only if a distortion analyzer is available.
-4	Maximum negative voltage	
L-4	SAME	Repeat steps 4 and 5 until dial calibration is accurate.
C-2, C-3	SAME	As output increases, attenuate signal generator to keep maximum output at TP#1 to less than 1 volt.
L-1, L-2, L3	SAME	Repeat steps 6 and 7 until output is as high as possible.
Primary (bottom) of T-5	0.5% distortion or less	Use a strong signal from the FM generator. Adjust T-5 primary for minimum distortion. IF A DISTORTION ANALYZER IS NOT AVAILABLE, OMIT THIS STEP. DO NOT ADJUST T-5 PRIMARY.
L-2, C-3	Minimum tilt	Observe direction of tilt of overall response curve at 105MC and 90MC. If direction is the same, adjust L-2 at 100MC for minimum tilt. Re-check tilt at 90MC and 105MC. If direction is not the same, adjust L-2 (at 90MC) and L-3 (at 105MC) for minimum tilt. Check tilt again at 100MC.
Muting threshold control		With FM generator set for 2.5 microvolts output, place muting control to "IN." Adjust the muting threshold control to the point at which the sine wave on the scope becomes erratic.
	IHFM Sensitivity 2.5 microvolts for 3% total noise and distortion	Step 11 is an overall sensitivity check. It requires a distortion analyzer and FM signal generator with attenuator. With 2.5 microvolts input at the 300 ohm terminals, TP#1 voltage should be .45 volts or more.

MAC 15 00 MULTIPLEX

STEPS	TUNER DIAL SETTING	SIGNAL GENERATOR			INDICATOR	
		FREQ.	COUPLING	MODULATION	TYPE	CONNECTED TO
1	Point of no interference or signal	Audio generator set to 67KC 0.5 volts output or less	TP#2		Audio VTVM	L or R tape output
2	SAME	MPX generator with 19KC pilot attenuated to approx. 5% level. (5% level is 1/2 of normal 10% level). 19KC pilot MUST be attenuated for correct alignment	SAME		DC VTVM	Pin 9 of 6EA8
3	100MC	100MC modulated by MPX generator. 19KC pilot at normal output	300 ohm antenna terminals with matching network. (See * previous page)	1KC 100% modulation (34 KC deviation) modulating left or right only	Audio VTVM	Pin 1 or 2 of T-7
4	SAME	SAME	SAME	SAME	Audio VTVM and scope	L or R tape output
5	SAME	SAME	SAME	SAME	SAME	SAME
6	SAME	SAME	SAME	SAME	SAME	SAME
7	SAME	SAME	SAME	Turn off 1 KC audio modulation	SAME	SAME
8	SAME	Tune to a strong mono FM station	SAME		MPX stereo indicator light on receiver	

DECODER ALIGNMENT

ADJUST	TEST LIMITS	REMARKS
67KC Trap (L-6)	Adjust for minimum voltage	Stereo light must be on. This is done by adjusting the "MPX Light Adj." control, R-12.
T-6 top and bottom; L-5	Adjust for maximum voltage	Stereo light must be off.
T-7 bottom core	SAME	Stereo light must be completely on.
T-7 top core	Adjust for stable scope display	<ol style="list-style-type: none"> 1. Turn off 19KC pilot on MPX generator. 2. Adjust upper core of T-7 to obtain a stable and uniform 1 KC signal scope display. This adjustment may be critical, so turn core very slowly. 3. Turn 19KC pilot back on.
L-5	30db separation or more	Modulate left channel and measure right channel output. Adjust L-5 for minimum right channel output (maximum separation). Be sure all test leads are removed from TP#2 for separation tests.
	SAME	Modulate right channel and measure left channel output. Separation in steps 5 and 6 should be at least 30db.
This step checks the rejection of 19KC and 38KC frequencies. Residual output should be at least 40db below modulated output.		
MPX light adjust control R-12		Turn control until light comes on. Then back off just enough to cause the light to go off. Then back off about 1/8 of a turn more. Light should operate ONLY on a MPX signal.

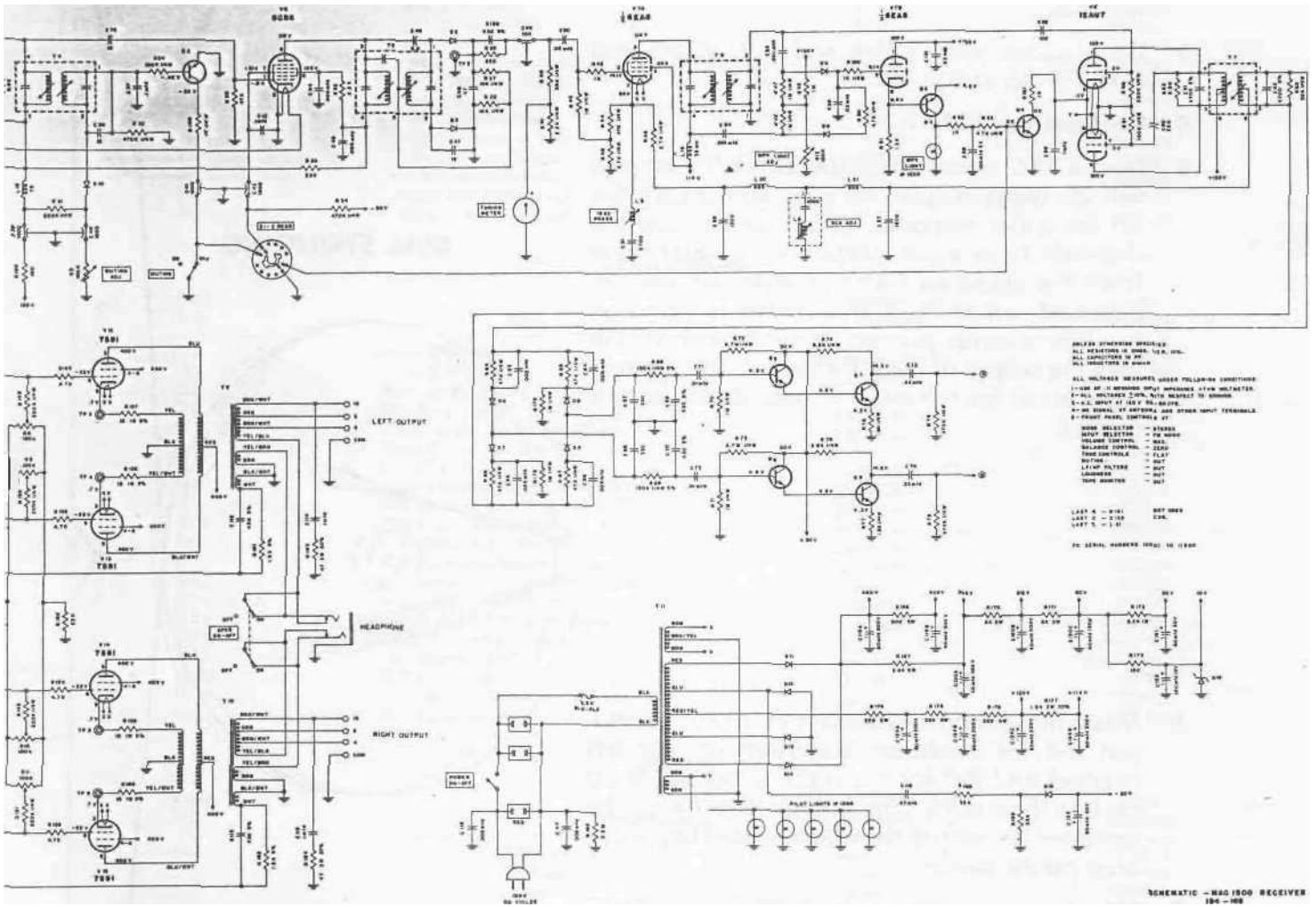

SCHEMATIC - HQ-100 RECEIVER
100-100

PREAMP/AMP TESTS AND ADJUSTMENTS

All adjustments should be made after a minimum of a 10 minute warm-up.

- 1 Remove the 12AX7 (V-9).
- 2 Measure the voltage at TP#3. Voltage should be 0.7 volts positive. If it is not 0.7 volts, adjust R-8.
- 3 Do likewise with TP#4 and R-9, TP#5 and R-10, TP#6 and R-11.
- 4 Re-insert the 12AX7.
- 5 Feed a 1 KC signal into AUX. Drive the amp to full 30 watts output. Be sure all controls are set for a flat response. Check to be sure the channels have equal output with equal drive from the audio oscillator. If channels are unbalanced, adjust R-55. This control is found on the left preamp printed circuit board. It will vary the output of the left channel. The preamp cover must be removed to gain access to this control.

- 6 Measure harmonic distortion at 30 cycles. Adjust R-6 for minimum distortion on the left channel and R-7 for the right. Distortion must be less than 0.5%. The bottom cover must be removed to adjust these controls. They have blue plastic knobs.
- 7 Now measure distortion at 2KC and 20KC. Must be less than 0.5% at full output.
- 8 Next, feed a signal thru the phono inputs. Check for correct RIAA equalization.
- 9 Remove all inputs. Check hum and noise on phono 1. Should be at least 60db below rated output.

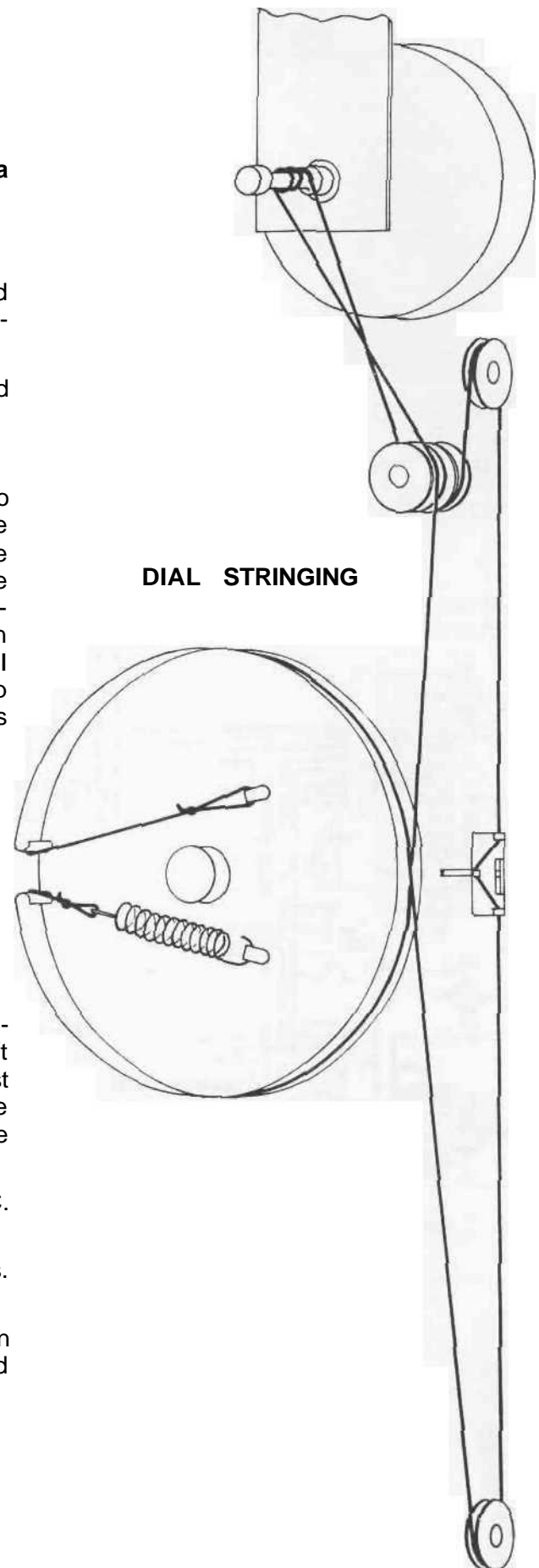

MAC 1500 PARTS LIST

TUBES

ITEM NO.	USE	TUBE NUMBER	PART NUMBER
V-1	HF Amplifier	6DS4	165-013
V-2	Mixer	6DS4	165-013
V-3	1st IF Amplifier	6AU6	165-004
V-4	2nd IF Amplifier	6AU6	165-004
V-5	3rd IF Amplifier, 1st Limiter	6AU6	165-004
V-6	4th IF Amplifier, 2nd Limiter	6CS6	165-011
V-7	19KC Amplifier, Indicator Control	6EA8	165-044
V-8	MPX 38KC Oscillator	12AU7	165-018
V-9	Voltage Amplifier	12AX7	165-019
V-10	Left Channel Driver	12AU7	165-018
V-11	Right Channel Driver	12AU7	165-018
V-12	Left Channel Output	7591	165-022
V-13	Left Channel Output	7591	165-022
V-14	Right Channel Output	7591	165-022
V-15	Right Channel Output	7591	165-022

TRANSISTORS

ITEM NO.	USE	TRANSISTOR NUMBER	PART NUMBER
Q-1	Local Oscillator	TA2556/40244	132-008
Q-2	Control Amplifier	2N3638	132-007
Q-3	MPX Lamp Control		132-010
Q-4	Oscillator On-Off Control		132-004
Q-5	Left Channel Audio Amplifier	2N3391A	1 32-004
Q-6	Right Channel Audio Amplifier	2N3391A	132-004
Q-7	Left Channel Audio Amplifier	2N3391A	132-004
Q-8	Right Channel Audio Amplifier	2N3391A	132-004
Q-9	Left Channel Low Level Amplifier	2N3391A	132-004
Q-10	Right Channel Low Level Amplifier	2N3391A	132-004
Q-11	Left Channel Emitter Follower	2N3391A	132-004
Q-12	Right Channel Emitter Follower	2N3391A	132-004
Q-13	Left Channel Low Level Amplifier	2N720A	132-002
Q-14	Right Channel Low Level Amplifier	2N720A	132-002
Q-15	Left Channel Emitter Follower	2N3391A	132-004
Q-16	Right Channel Emitter Follower	2N3391A	132-004
Q-17	Left Channel Emitter Follower	2N3391A	132-004
Q-18	Right Channel Emitter Follower	2N3391A	132-004
Q-19	Left Channel Voltage Amplifier	2N720A	132-002
Q-20	Right Channel Voltage Amplifier	2N720A	132-002

DIODES

ITEM NO.	DESCRIPTION	DIODE NUMBER	PART NUMBER
D-1	Diode	FD100	070-022
D-2	Diode	FD100	070-022
D-3	Diode	FD100	070-022
D-4	Diode	FD100	070-022
D-5	Diode	FD100	070-022
D-6	Diode [Matched pair 1N542]	1N542	070-003
D-7	Diode (Matched pair 1N542)	1N542	070-003
D-8	Diode (Matched pair 1N542)	1N543	070-003
D-9	Diode (Matched pair 1N542)	1N542	070-003
D-10	Diode (Matched pair 1N542)		070-003
D-11	800 PIV @ 750MA Silicon Rectifier		070-017
D-12	600 PIV @ 750MA Silicon Rectifier		070-016
D-13	600 PIV @ 750MA Silicon Rectifier		070-016
D-14	800 PIV @ 750MA Silicon Rectifier		070-017
D-15	400 PIV @ 750MA Silicon Rectifier		070-015
D-16	10 V @ 400 MW Zener Rectifier		070-011

CONTROLS

ITEM NO.	FUNCTION	RESISTANCE	PART NUMBER
R-1	Balance Control	500K-500K	134-165
R-2	Bass Control	1M-1M	134-117
R-3	Treble Control	500K-500K	134-118
R-4	Volume Control	60K-60K	134-164
R-5	Muting Adjust Control	100K	134-102
R-6	Driver Balance Control	5K	134-103
R-7	Driver Balance Control	5K	134-103
R-8	Bias Adjust Control	100K	134-102
R-9	Bias Adjust Control	100K	134-102
R-10	Bias Adjust Control	100K	134-102
R-11	Bias Adjust Control	100K	134-102
R-12	MPX Light Adjust Control	100K	134-102
R-55	Left Channel Gain Control	5K	134-120

SWITCHES

ITEM NO.	FUNCTION	DESCRIPTION	PART NUMBER
S-1	Rotary Switch	Input Selector	1 46-096
	SS-26 19/32 Trigger Slide Switch	Muting On-Off	148-003
	SS-50 7/32 Trigger Slide Switch	Speaker On-Off	148-006
	SS-50 19/32 Trigger Slide Switch (S used)	Stereo/Mono, Tape Monitor, LF and HF Fillers, Loudness.	148-007

TRANSFORMERS

ITEM NO.	FUNCTION	PART NUMBER
T-1	FM-IF	162-005
T-2	FM-IF	162-004
T-3	FM-IF	162-004
T-4	IF (Muting)	162-029
T-5	FM Discriminator	162-027
T-6	19KC Amplifier	162-010
T-7	38KC Oscillator	162-009
T-8	Balun	076-006
T-9	Output (Left)	159-062
T-10	Output (Right)	159-062
MI	Power	159-061

CAPACITORS

ITEM NO.	DESCRIPTION	CAPACITANCE	TOLERANCE	PART NUMBER
C-1	Variable FM			059-006
C-2	Trimmer (Ceramic)	1-8 PF		060-001
C-3	Trimmer (Ceramic)	1-8 PF		060-001
C-4	Trimmer (Glass)			060-002
C-5	Ceramic Disc.	.005MFD	+80-20%	061-040
C-6	Ceramic Disc.	.001 MFD		061-035
C-7	Ceramic Disc.	.001 MFD		061-035
C-8	Ceramic Feed-Thru	.001MFD		061-036
C-9	Ceramic Feed-Thru	.001MFD		061-036
C-10	Ceramic Disc.	10PF	20% NPO	061-009
C-11	Ceramic Tubular	5PF	±25PF N150	061-005
C-13	Ceramic Disc.	.005	+80-20%	061-040
C-16	Ceramic Disc.	10PF	20% NPO	061-009
C-17	Ceramic Tubular	3PF	±25PF	061-003
C-18	Ceramic Disc.	10PF	20% NPO	061-009
C-19	Ceramic Feed-Thru	.001 MFD		061-036
C-20	Ceramic Feed-Thru	.001MFD		061-036
C-21	Ceramic Feed-Thru	.001 MFD		061-036
C-22	Ceramic Disc.	.005MFD	+80-20%	061-040
C-23	Ceramic Disc.	10PF	20% NPO	061-009
C-24	Ceramic Disc.	.005 MFD	+80-20%	061-040
C-27	Ceramic Feed-Thru	.001 MFD		061-036
C-28	Ceramic Feed-Thru	.001MFD		061-036
C-29	Ceramic Disc.	.005MFD	+80-20%	061-040
C-30	Ceramic Disc.	.01 MFD	+80-20%	061-043

CAPACITORS

HEM NO.	DESCRIPTION	CAPACITANCE	VOLTAGE	TOLERANCE	PART NUMBER
C-31	Ceramic Disc.	12PF		20% NPO	061-010
C-32	Ceramic Disc.	.1MPD		+80-20%	061-049
C-33	Ceramic Disc.	.005MFD		+80-20%	061-040
C-34	Ceramic Disc.	.005MFD		+80-20%	061-040
C-35	Ceramic Disc.	.01 MFD		+80-20%	061-043
C-36	Ceramic Tubular	15PF		±.75PF N150	061-012
C-37	Flat Foil	.1MFD	40V	20%	064-027
C-38	Ceramic Feed-Thru	.001 MFD			061-036
C-40	Ceramic Feed-Thru	.001 MFD			061-036
C-41	Ceramic Feed-Thru	.001 MFD			061-036
C-42	Ceramic Feed-Thru	.001 MFD			061-036
C-43	Ceramic Disc.	.1MFD		+80-20%	061-049
C-44	Ceramic Disc.	.005MFD		+80-20%	061-040
C-45	Ceramic Disc.	.005MFD		+80-20%	061-040
C-46	Ceramic Disc.	6.8PF		20% NPO	061-008
C-47	Ceramic Disc.	12PF		20% NPO	061-010
C-48	Ceramic Disc.	47PF		20% N470	061-019
C-49	Ceramic Feed-Thru	100PF		20%	061-021
C-50	Ceramic Disc.	.02MFD		+80-20%	061-045
C-51	Silver Mica	.0027MFD	100V	5%	063-004
C-52	Ceramic Disc.	100PF		10% N1500	061-023
C-53	Ceramic Disc.	.001MFD			061-035
C-54	Ceramic Disc.	.001MFD			061-035
C-55	Ceramic Disc.	.02MFD		+80-20%	061-045
C-56	Silver Mica	.0012MFD	100V	5%	063-002
C-57	Silver Mica	.0012MFD	100V	5%	061-002
C-58	Electrolytic	100MFD	3V		066-047
C-59	Ceramic Disc.	.1MFD		+80-20%	061-049
C-60	Ceramic Disc.	220PF		20%	061-028
C-61	Silver Mica	.0047MFD		5%	063-005
C-62	Silver Mica	.0047MFD		5%	063-005
C-63	Ceramic Disc.	.005MFD		+80-20%	061-040
C-64	Ceramic Disc.	.005MFD		+80-20%	061-040
C-65	Ceramic Disc.	.005MFD		+80-20%	061-040
C-66	Ceramic Disc.	.005MFD		+80-20%	061-040
C-67	Ceramic Disc.	330PF		10%	061-029
C-68	Ceramic Disc.	330PF		10%	061-029
C-69	Ceramic Tubular	430PF		5%	061-031
C-70	Ceramic Tubular	430PF		5%	061-031
C-71	Ceramic Disc.	.01 MFD		+80-20%	061-043
C-72	Ceramic Disc.	.01 MFD		+80-20%	061-043
C-73	Flat Foil	.22MFD	40V	20%	064-024
C-74	Flat Foil	.22MFD	40V	20%	064-024
C-75	Ceramic Disc.	10PF		20% NPO	061-009
C-76	Flat Foil	.22MFD	40V	20%	064-024
C-77	Flat Foil	.22MFD	40V	20%	064-024
C-7B	Ceramic Disc.	.1MFD		+80-20%	061-049
C-79	Ceramic Disc.	.1MFD		+80-20%	061-049
C-80	Electrolytic	100MFD	12V		066-018
C-81	Electrolytic	100MFD	12V		066-018
C-82	Ceramic Disc.	.1MFD		+80-20%	061-049
C-83	Ceramic Disc.	.1MFD		+80-20%	061-049
C-84	Ceramic Disc.	.0012MFD		10%	061-051
C-85	Ceramic Disc.	.0012MFD		10%	061-051
C-86	Ceramic Tubular	430PF		5%	061-031
C-87	Ceramic Tubular	430PF		5%	061-031
C-88	Flat Foil	.22MFD	40V	20%	064-024
C-89	Flat Foil	.22MFD	40V	20%	064-024
C-90	Flat Foil	.22MFD	40V	20%	064-024
C-91	Flat Foil	.22MFD	40V	20%	064-024
C-92	Molded Film	.22MFD	200V	20%	064-013
C-93	Molded Film	.22MFD	200V	20%	064-013
C-94	Electrolytic	100MFD	12V		066-018
C-95	Electrolytic	100MFD	12V		066-018
C-96	Mylar	.47MFD	100V	10%	064-019
C-97	Mylar	.7MFD	10CV	10%	064-019
C-98	Ceramic Disc.	.0015MFD		10%	061-038
C-99	Ceramic Disc.	.0015MFD		10%	061-038
C-100	Flat Foil	.047MFD	40V	20%	064-036
C-101	Flat Foil	.047MFD	40V	20%	064-036
C-102	Electrolytic	100MFD	3V		066-047
C-103	Electrolytic	100MFO	3V		066-047
C-104	Ceramic Disc.	47PF		20% N470	061-019
C-105	Ceramic Disc.	47PF		20% N470	061-019
C-106	Mylar	.25MFD	400V	10%	064-016
C-107	Mylar	.25MFD	400V	10%	064-016
C-108	Mylar	.1MFD	600V	10%	064-012
C-109	Mylar	.1MFD	600V	10%	064-012
C-110	Mylar	.1MFD	600V	10%	064-012
C-111	Mylar	.1MFD	600V	10%	064-012
C-112	Ceramic Tubular	430 PF		5%	061-031
C-113	Ceramic Tubular	430PF		5%	061-031

8-119

CAPACITORS

ITEM NO.	DESCRIPTION	CAPACITANCE	VOLTAGE	TOLERANCE	PART NUMBER
C-114	Mylar	.1MFD	125V	10%	064-028
C-115	Mylar	.1MFD	125V	10%	064-028
C-116	Ceramic Disc.	.005MFD	1400V		061-052
C-117	Ceramic Disc.	.005MFD	1400V		061-052
C-118	Mylar	.47MFD	200V	10%	064-020
C-119	Electrolytic	60-40MFD	500V-500V		066-026
C-120	Electrolytic	40-40-40 MFD	450V-300V- 150V		066-032
C-121	Tubular	50MFD	50V		066-014
C-122	Tubular	100MFD	12V		066-018
C-123	Tubular	50MFD	50V		066-014
C-124	Electrolytic	50-50-50- 50MFD	200V-200V- 200V-200V		066-036
C-125	Ceramic Disc.	.001 MFD			061-035
C-126	Ceramic Feed-Thru	.001 MFD			061-036
C-127	Ceramic Disc.	.005MFD		+80-20%	061-040
C-128	Fixed Composition	.18PF		10%	069-001
C-129	Fixed Composition	.18PF		10%	069-001
C-130	Ceramic Tubular	430PF		5%	061-031
C-131	Ceramic Disc.	.02MFD		+80-20%	061-045
C-132	Ceramic Tubular	5PF		±.25PF N220	061-007
C-133	Ceramic Disc.	1SOPF		20%	061-025
C-134	Ceramic Disc.	150PF		20%	061-025
C-135	Ceramic Disc.	4.7PF		20% NPO	061-004

COILS

ITEM NO.	DESCRIPTION	VALUE	PART NUMBER
L-1	Antenna Coil		122-035
L-2	R.F. Coil		1 22-054
L-3	Mixer Coil		1 22-055
L-4	OSC. Coil		1 22-056
L-5	Peaking Coil	19KC	122-008
L-6	Filter Coil	67KC Trap	122-009
L-7	Neutralizing Choke	2.5 Micro H 3%	122-033
L-8	Parasitic Choke		122-028
L-9	RF Choke	1.2 Micro H	122-011
L-10	RF Choke	1.2 Micro H	122-011
L-11	RF Choke	1.2 Micro H	122-011
L-12	RF Choke	1.2 Micro H	122-011
L-13	RF Choke	1.2 Micro H	122-011
L-14	RF Choke	1.2 Micro H	122-011
L-15	RF Choke	1.2 Micro H	122-011
L-16	RF Choke	1.2 Micro H	122-011
L-17	RF Choke	1.2 Micro H	122-011
L-16	RF Choke	75 Micro H	122-013
L-19	Peaking Coil	38 Micro H	122-014
L-20	Filter Coil	Lo Pass	122-015
L-21	Filler Coil	Lo Pass	122-015

RESISTORS

ITEM NO.	RESISTANCE	TOLERANCE	WATTAGE	PART NUMBER
R-13	47K	10%	¼W	136-339
R-14	100 ohms	10%	½W	136-068
R-15	15K	10%	¼W	136-377
R-16	3.3K	10%	¼W	136-385
R-17	220 ohms	10%	¼W	136-396
R-16	1K	10%	½W	136-110
R-19	470K	10%	¼W	136-373
R-20	1M	10%	½W	136-236
R-21	100 ohms	10%	½W	136-068
R-22	1K	10%	½W	136-110
R-23	100 ohms	10%	½W	136-068
R-24	10K	10%	½W	136-152
R-25	10M	10%	½W	136-278
R-26	47K	10%	¼W	136-339
R-27	470K	10%	¼W	136-222
R-2S	100K	10%	½W	136-301
R-29	1K	10%	½W	136-110
R-30	6.8K	10%	½W	136-145
R-31	220K	10%	¼W	136-372
R-32	470K	10%	¼W	136-373
R-33	47K	10%	½W	136-180
R-34	470K	10%	¼W	136-373
R-35	2.2K	10%	½W	136-124

RESISTORS

ITEM NO.	RESISTANCE	TOLERANCE	WATTAGE	PART NUMBER
R-36	220 ohms	10%	¼W	136-082
R-37	10K	10%	¼W	136-382
R-38	10K	10%	¼W	136-382
R-39	22K	10%	¼W	136-166
R-40	39K	10%	¼W	136-370
H-41	2.2K	10%	¼W	136-367
R-42	1K	10%	¼W	136-110
R-43	1M	10%	¼W	136-303
R-44	470 ohms	10%	¼W	136-295
R-45	4.7K	10%	¼W	136-298
R-46	2.7K	10%	¼W	136-297
R-47	1M	10%	¼W	136-303
R-48	1M	10%	¼W	136-303
R-49	1M	10%	¼W	136-236
R-50	4.7K	10%	¼W	136-298
R-S1	1.2K	10%	¼W	136-114
R-52	1K	10%	¼W	136-296
R-53	4.7K	10%	¼W	136-298
R-54	100K	10%	¼W	136-301
R-60	220K	10%	¼W	136-372
R-61	100K	10%	¼W	136-301
R-62	6.8K	10%	¼W	136-145
R-63	22K	10%	¼W	136-369
R-64	47K	10%	¼W	136-339
R-65	47K	10%	¼W	136-339
R-66	47K	10%	¼W	136-339
R-67	47K	10%	¼W	136-339
R-68	150K	5%	¼W	136-371
R-69	150K	5%	¼W	136-371
R-70	1M	10%	¼W	136-303
R-71	1M	10%	¼W	136-303
R-72	4.7M	10%	¼W	136-374
R-73	4.7M	10%	¼W	136-374
R-74	6.8K	10%	¼W	136-368
R-75	6.8K	10%	¼W	136-368
R-76	1.8K	10%	¼W	136-381
R-77	1.8K	10%	¼W	136-381
R-78	470K	10%	¼W	136-373
R-79	470K	10%	¼W	136-373
R-80	1M	10%	¼W	136-303
R-81	1M	10%	¼W	136-303
R-82	4.7M	10%	¼W	136-374
R-83	4.7M	10%	¼W	136-374
R-84	1K	10%	¼W	136-296
R-85	1K	10%	¼W	136-296
R-86	1M	10%	¼W	136-303
R-87	1M	10%	¼W	136-303
R-88	1.2K	5%	¼W	136-394
R-89	1.2K	5%	¼W	136-394
R-90	100K	10%	¼W	136-301
R-91	100K	10%	¼W	136-301
R-92	27K	10%	¼W	136-379
R-93	27K	10%	¼W	136-379
H-94	220K	10%	¼W	136-372
R-95	220K	10%	¼W	136-372
R-96	680 ohms	10%	¼W	136-378
R-97	630 ohms	10%	¼W	136-378
R-98	15K	10%	¼W	136-377
R-99	15K	10%	¼W	136-377
R-100	3.3M	10%	¼W	136-380
R-101	3.3M	10%	¼W	136-380
R-102	130K	5%	¼W	136-387
R-103	180K	5%	¼W	136-387
R-104	47K	10%	¼W	136-339
R-105	47K	10%	¼W	136-339
R-106	22K	10%	¼W	136-369
R-107	47K	10%	¼W	136-339
R-108	22K	10%	¼W	136-369
R-109	47K	10%	¼W	136-339
R-110	47K	5%	¼W	136-388
R-111	47K	5%	¼W	136-388
R-112	1M	10%	¼W	136-303
R-113	1M	10%	¼W	136-303
R-114	1M	10%	¼W	136-303
R-115	1M	10%	¼W	136-303
R-116	27K	10%	¼W	136-379
R-117	27K	10%	¼W	136-379
R-118	100K	10%	¼W	136-301
R-119	100K	10%	¼W	136-301
R-120	470K	10%	¼W	136-373
R-121	470K	10%	¼W	136-373
R-122	18K	10%	¼W	136-386
R-123	18K	10%	¼W	136-386

RESISTORS

ITEM NO.	RESISTANCE	TOLERANCE	WATTAGE	PART NUMBER
R-124	7.5K	5%	¼W	136-376
R-125	4.7K	10%	¼W	136-298
R-126	7.5K	5%	¼W	136-376
R-127	4.7K	10%	¼W	136-298
R-128	150 ohms	10%	¼W	136-294
R-129	150 ohms	10%	¼W	136-294
R-130	5.6K	5%	¼W	136-397
H-131	5.6K	5%	¼W	136-397
R-132	3.3K	10%	½W	136-131
R-133	3.3K	10%	½W	136-131
R-134	100 ohms	5%	½W	136-067
R-135	100 ohms	5%	½W	136-067
R-136	330K	10%	½W	136-215
R-137	330K	10%	½W	136-215
R-J3S	15K	10%	½W	136-159
R-139	15K	10%	½W	136-159
R-140	1.2M	10%	½W	136-240
R-141	1.2M	10%	½W	136-240
R-142	18K	10%	1W	136-313
R-143	18K	10%	1W	136-313
R-144	27K	10%	1W	136-316
R-145	27K	10%	1W	136-316
R-146	30K	5%	1W	136-317
R-147	30K	5%	1W	136-317
R-148	220K	10%	¼W	136-372
R-149	220K	10%	¼W	136-372
R-150	220K	10%	¼W	136-372
R-151	220K	10%	¼W	136-372
R-152	22K	10%	½W	136-166
R-153	4.7K	10%	½W	136-138
R-151	4.7K	10%	½W	136-138
R-155	4.7K	10%	½W	136-138
R-156	4.7K	10%	½W	136-138
R-157	15 ohms	5%	1W	139-034
R-158	15 ohms	5%	1W	139-034
R-159	15 ohms	5%	1W	139-034
R-160	15 ohms	5%	1W	139-034
R-161	1.8K	5%	½W	136-120
R-162	1.8K	5%	½W	136-120
R-163	47 ohms	20%	2W	136-323
R-164	47 ohms	20%	2W	136-323
R-165	2.2M	10%	½W	136-250
R-166	900 ohms	10%	5W	139-012
R-167	3.6 K	10%	5W	139-013
R-168	33K	10%	½W	136-173
R-169	33K	10%	½W	136-173
R-170	6K	10%	5W	139-033
R-171	6K	10%	5W	139-033
R-172	8.2K	10%	1W	136-311
R-173	18K	10%	½W	136-163
R-174	220 ohms	10%	5W	139-009
R-175	220 ohms	10%	5W	139-009
R-176	220 ohms	10%	5W	139-009
R-177	1.5K	20%	2W	136-329
R-178	1M	10%	¼W	136-303
R-179	1M	10%	¼W	136-303
R-180	1K	10%	½W	136-110
MSI	1K	10%	½W	136-110
R-182	470K	10%	½W	136-222
R-183	27K	10%	¼W	136-379
R-184	27K	10%	¼W	136-379
R-185	1M	10%	¼W	136-303
R-186	1M	10%	¼W	136-303
R-187	1K	10%	½W	136-110
R-188	10K	10%	¼W	136-382
R-189	100 ohms	10%	½W	136-068
R-190	1K	10%	¼W	136-296
R-191	470K	10%	¼W	136-373

MISCELLANEOUS

Lamp, MPX #1850	058-006	Knob (¼" without index) Tuning	043-479
Lamp, Incandescent #1866	058-014	Knob (1⅛" with index) Volume, Selector, Balance	043-480
Dial Glass	016-052	Knob (1⅛" with index) Bass, Treble	090-070
Extrusion Glass	016-053	Knob (¾" with index) Bass, Treble	090-071
End Cap	018-080		
Lower Panel Extrusion	018-094		
Upper Panel Extrusion	018-095		
Fuse — 3.2 Amp Slo-Blo	089-006		
Tuning Meter	124-006		
Tone Control Module	130-007		
Rumble and HF Module	130-025		

MAC 1500 TOP and BOTTOM VIEWS

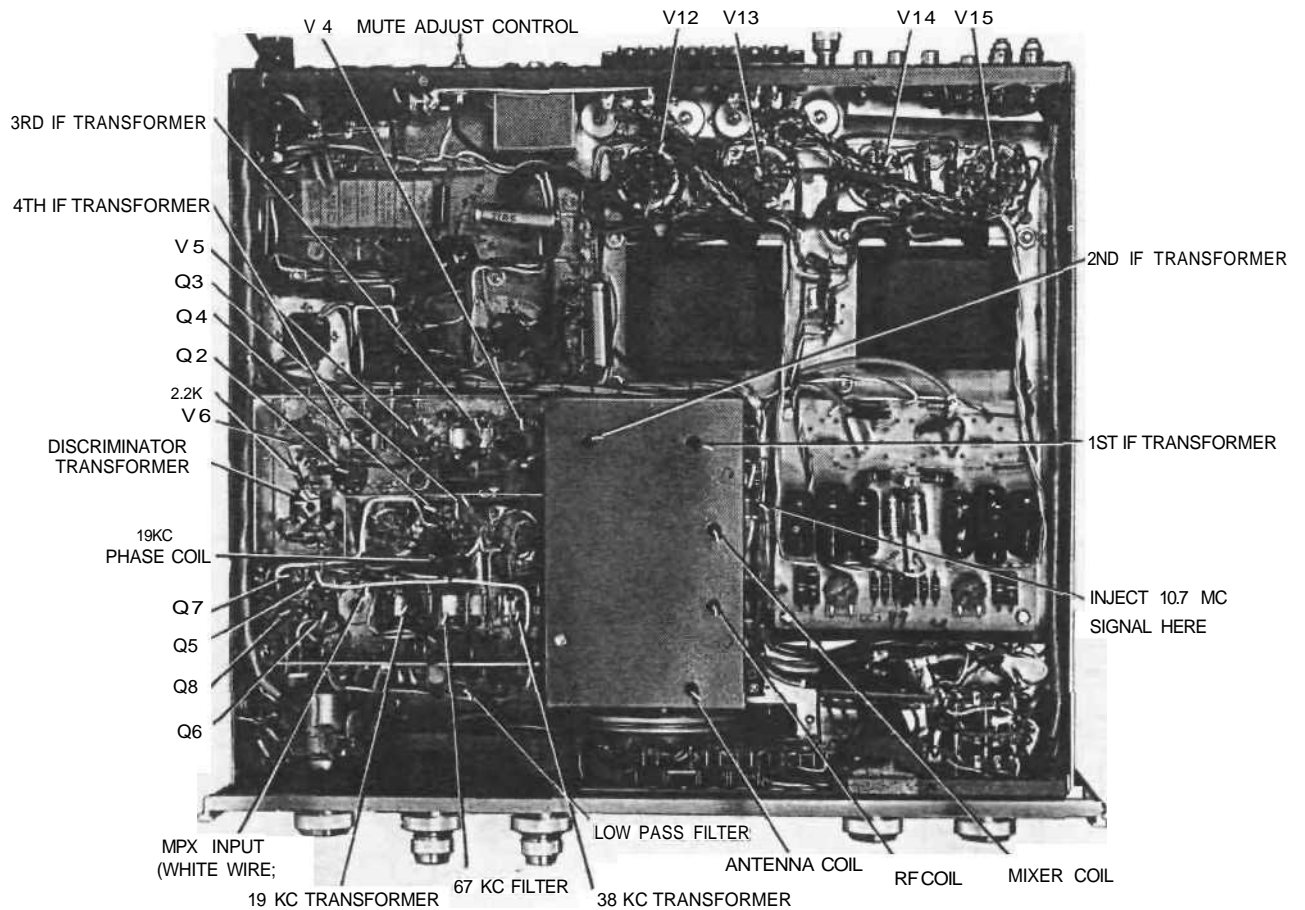
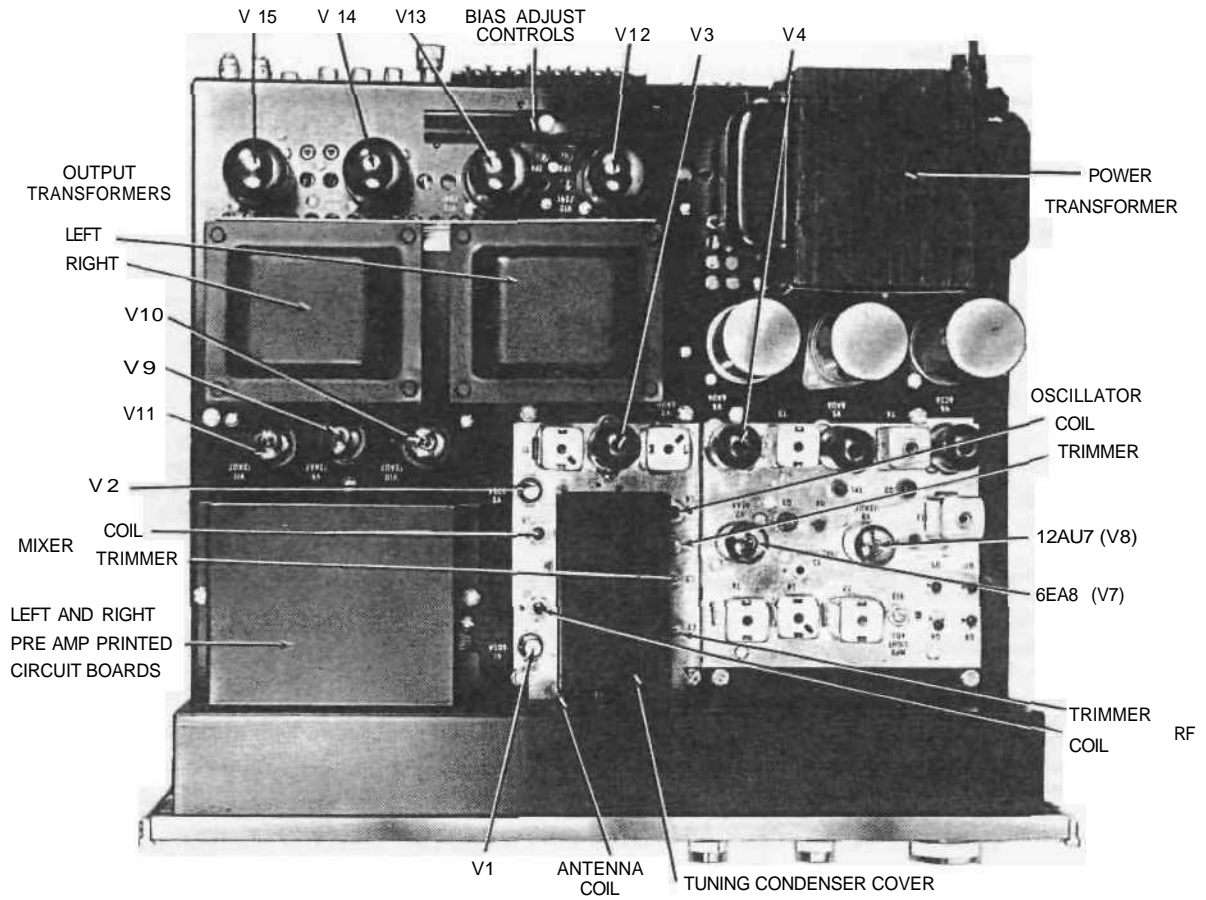

SPECIFICATIONS

FM TUNER SECTION:

USABLE SENSITIVITY (100% modulation): 2.5uV (I.H.F. Standards)

SIGNAL TO NOISE AND HUM RATIO: 65db.

HARMONIC DISTORTION: Mono, less than .5%
Stereo, less than .8%

DRIFT: less than 25KC

FREQUENCY RESPONSE: Flat from 20 cps to 20KC with standard 75 μ second deemphasis and 19KC pilot frequency filter.

CAPTURE RATIO: Better than 2.0db.

IMAGE REJECTION: Better than 60db.

STEREO MULTIPLEX SEPARATION: Better than 30db at 1 KC.

SPECIAL FEATURES:

- Automatic stereo switching.
- Muting: IF Injected circuit with at least 50db quieting between stations.
- Antenna inputs for 300 ohm balanced (for twin lead) and 75 ohm unbalanced (for coaxial cable).
- Nuvistor RF amplifier, Nuvistor mixer.
- Four stages of IF amplification, with AGC used to insure that limiting occurs only in the limiter stages.
- Two limiter stages used for exceptional capture ratio and smooth muting operation.
- Multiplex filter and SCA filter, to suppress 19KC and 38KC signal components at least 40db below program and to suppress 67KC SCA by 60db.
- Noise immune logic circuit used to activate MPX stereo light and automatic stereo switching on 19KC stereo pilot only.
- D'Arsonval tuning meter for accurate center of channel tuning.
- Flywheel tuning for ease of operation and precise tuning.

AMPLIFIER SECTION:

POWER OUTPUT: 60 watts continuous, 30 watts per channel, 65 watts total music power (I.H.F. Standards).

HARMONIC DISTORTION: less than 0.5% 30 cps to 20KC, both channels operating at rated output at the same time.

INTERMODULATION DISTORTION: Less than 0.5% for any combination of frequencies from 30 cps to 20KC at rated output (equivalent RMS watts). I.M. decreases as output power is reduced.

FREQUENCY RESPONSE: ±0.5db 20 cps to 20KC. (Power amplifier response is 2 cps to 150KC at -3db; power bandwidth is 19 cps to 30KC.)

OUTPUT IMPEDANCE: 4, 8, and 16 ohms. Rated output is delivered by any of these impedances.

DAMPING FACTOR: Greater than 1.0.

INPUT SENSITIVITY AND IMPEDANCE:

Tape Head—2.8MV, 1 megohm
Phono 1—5.6MV, 47K ohms
Phono 2—2.8MV, 47K ohms
Aux—400MV, 500K ohms
Tape Monitor—400MV, 500K ohms

TAPE OUTPUT LEVEL: Tuner-1.2 volts, for other Inputs 400MV at rated sensitivity.

HUM AND NOISE:

Power Amplifier, -90db
High Level Inputs, -75db
Low Level Inputs, -60db

tone CONTROL RANGE:

Bass control +1 5db to -1 8db at 50 cps.
Treble control +1 5db to -1 5 db at 10KC.

L.F. and H.F. FILTER:

L.F. filter, cutoff frequency = 50 cps,
attenuation rate - 1 2db per octave

H.F. Filter, cutoff frequency = 5KC.
attenuation rate = 1 2db per octave

SPECIAL FEATURES:

- Loudness control for full fidelity listening levels.
- Tape monitor switch for listening to recorded tape program while recording.
- Tone controls are "clutched" for tracking operation of left and right channels or independent operation.
- Headphone output fed from special tap on output transformer for maximum signal to noise ratio. Speakers may be automatically muted when headphone plug is inserted, by use of rear mounted switch.
- Silicon transistors used in all preamplifier stages for low noise and hum free operation.
- High quality epoxy circuit boards for reliable long life performance.
- High quality conservatively operated components are used throughout for long life.
- Zener regulated power supply is used for critical circuits.
- Equalization and tone control circuits are feedback type for lowest distortion and greatest accuracy.

MISCELLANEOUS

FINISH: Gold anodized panel and knobs, black finished chassis.

DIMENSIONS: 16" wide, 5½" high, 16" deep.

WEIGHT: 40 lbs., shipping weight 54 lbs.

POWER CONSUMPTION: 180 watts, 120 volts, 60 cps.

TRANSISTOR AND TUBE COMPLEMENT:

- 19 silicon transistors
- 1 germanium transistor
- 15 tubes
- 1 6 diodes, rectifier, and zener diode

BLOCK DIAGRAM

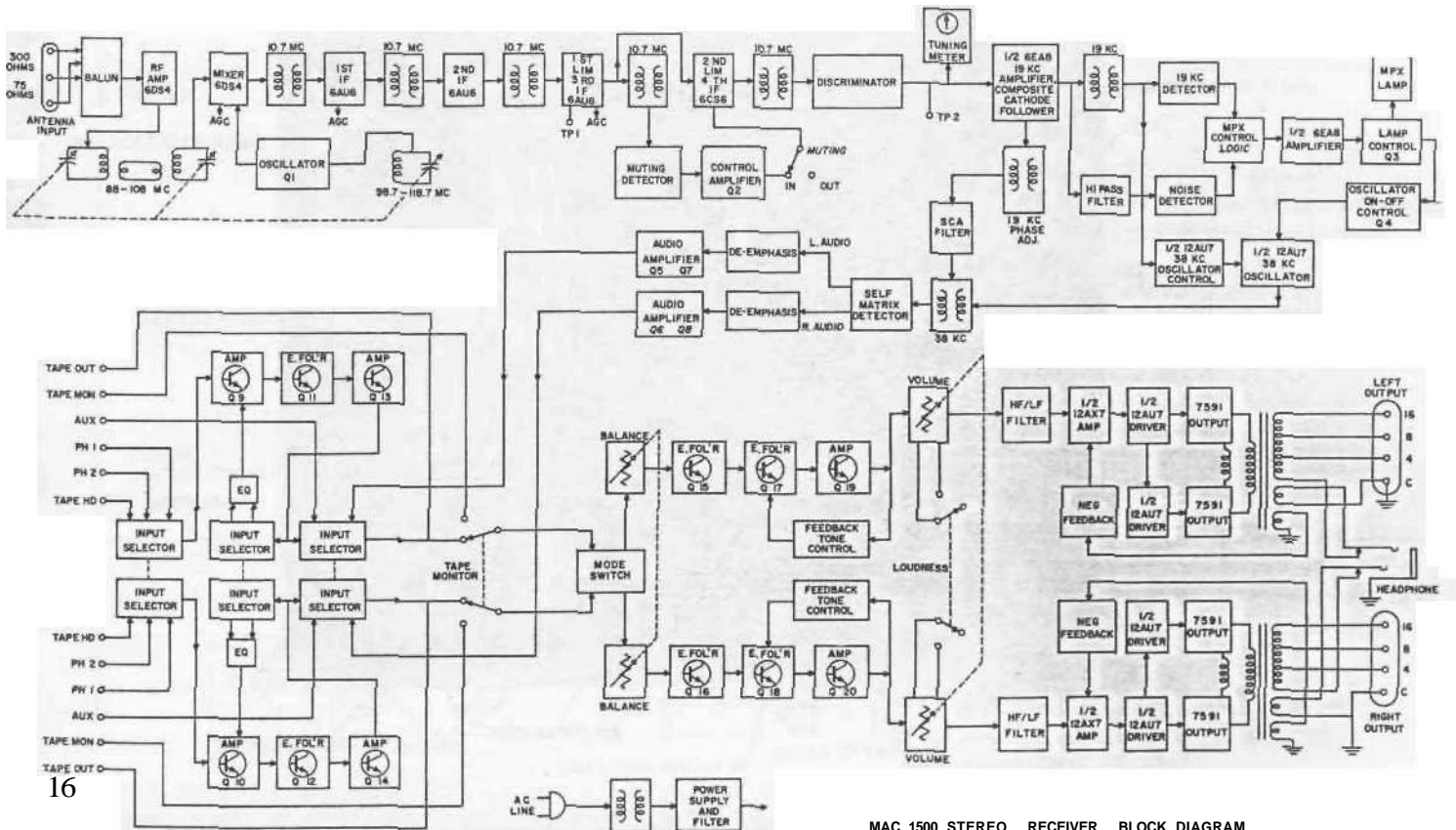

MAC 1500 STEREO RECEIVER BLOCK DIAGRAM

McINTOSH AUDIO COMPANY

2 Chambers St., Binghamton, N.Y. 13903

Made In U.S.A.

Phone—Area Code **607-723-5491**

Design **subject to** change without notice.