



SERVICE MANUAL

SERVICE MANUAL

MODEL: M3

SERVICE MANUAL

downloaded from <http://receiverfaq.ru/>

© NAD 2005

M25 C/AH

SEVEN CHANNEL AMPLIFIER

M25 C/AH
SEVEN CHANNEL AMPLIFIER

M25 C/AH



M25 C/AH
SEVEN CHANNEL AMPLIFIER

**NAD ELECTRONICS INTERNATIONAL
TORONTO**

WIRING DIAGRAM

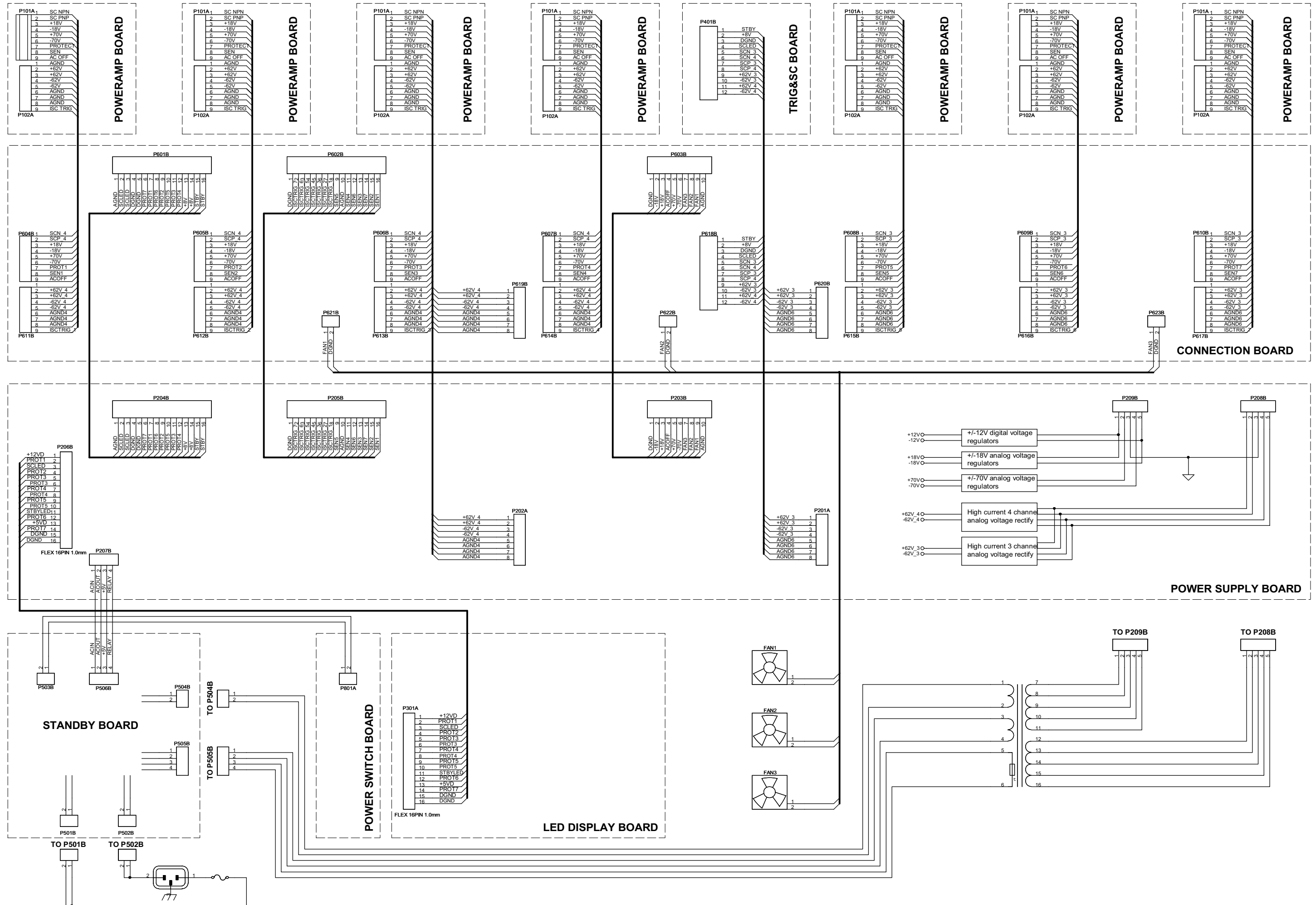

SCHEMATICS DIAGRAM

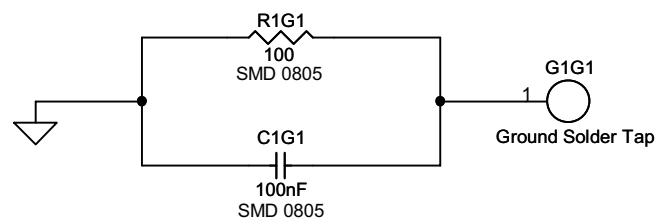
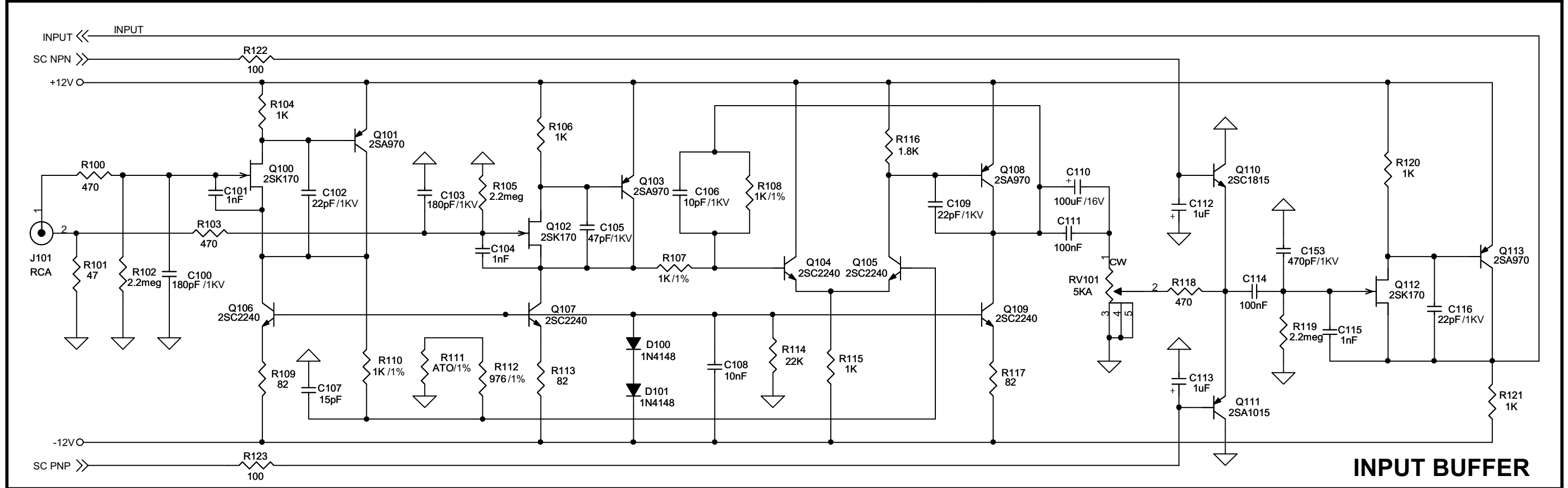
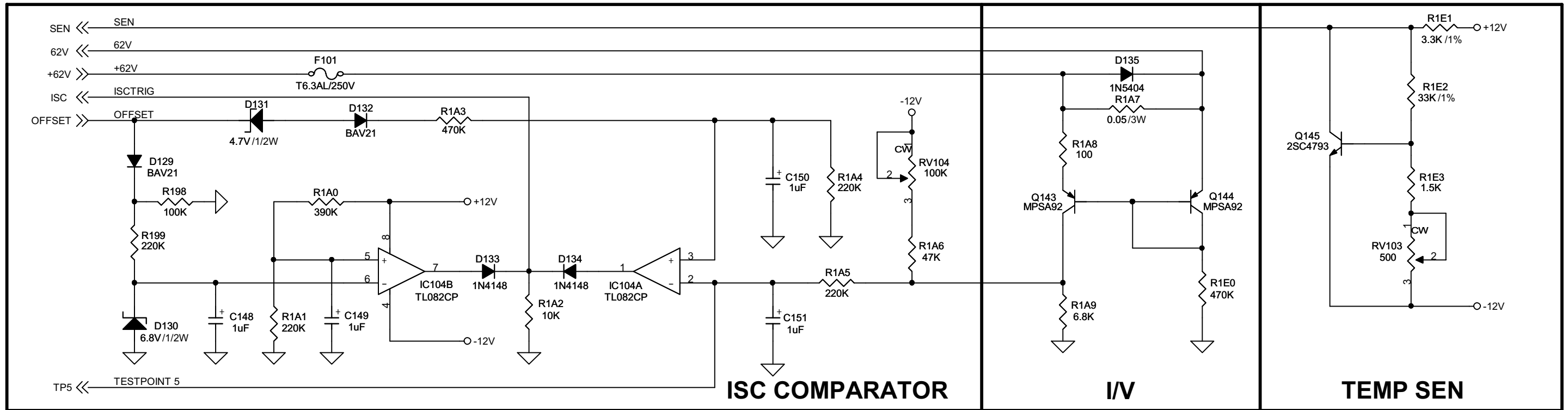

All Polyester capacitors are 63V unless noted.
 All Elec. capacitors are 50V unless noted.
 All Resistor are 1/6W RJ13 unless noted.

SCHEMATICS DIAGRAM

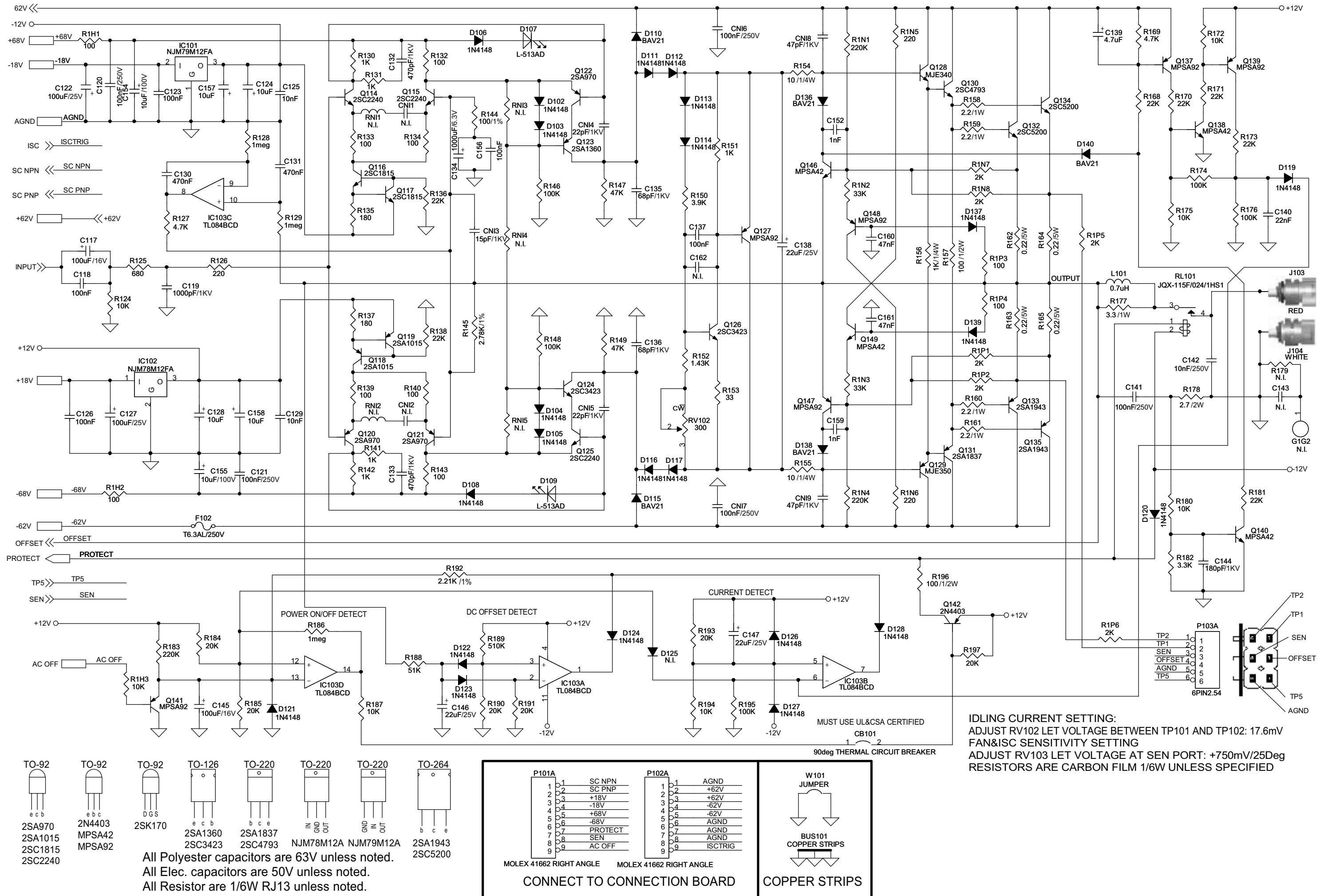

SCHEMATICS DIAGRAM

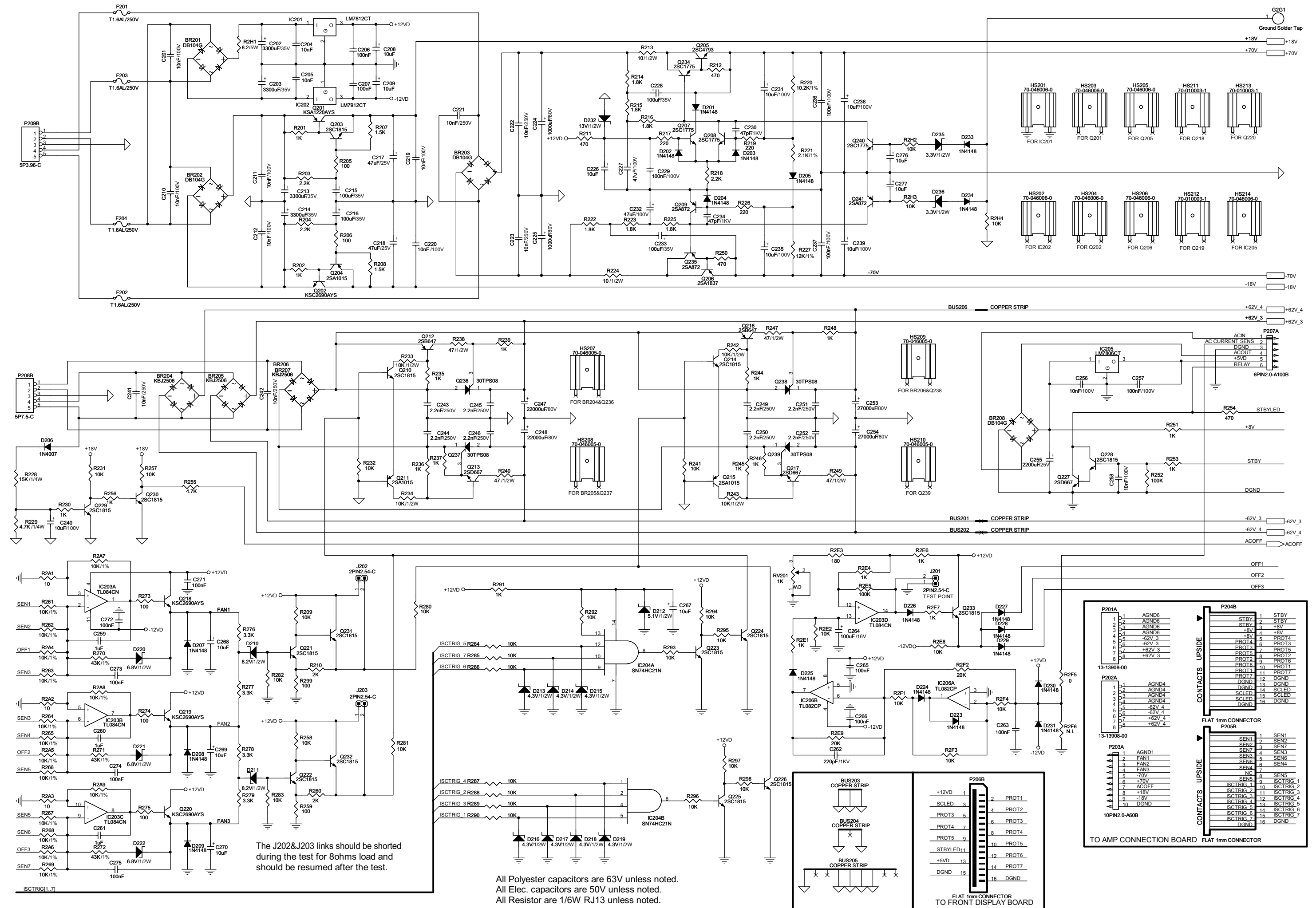

SCHEMATICS DIAGRAM

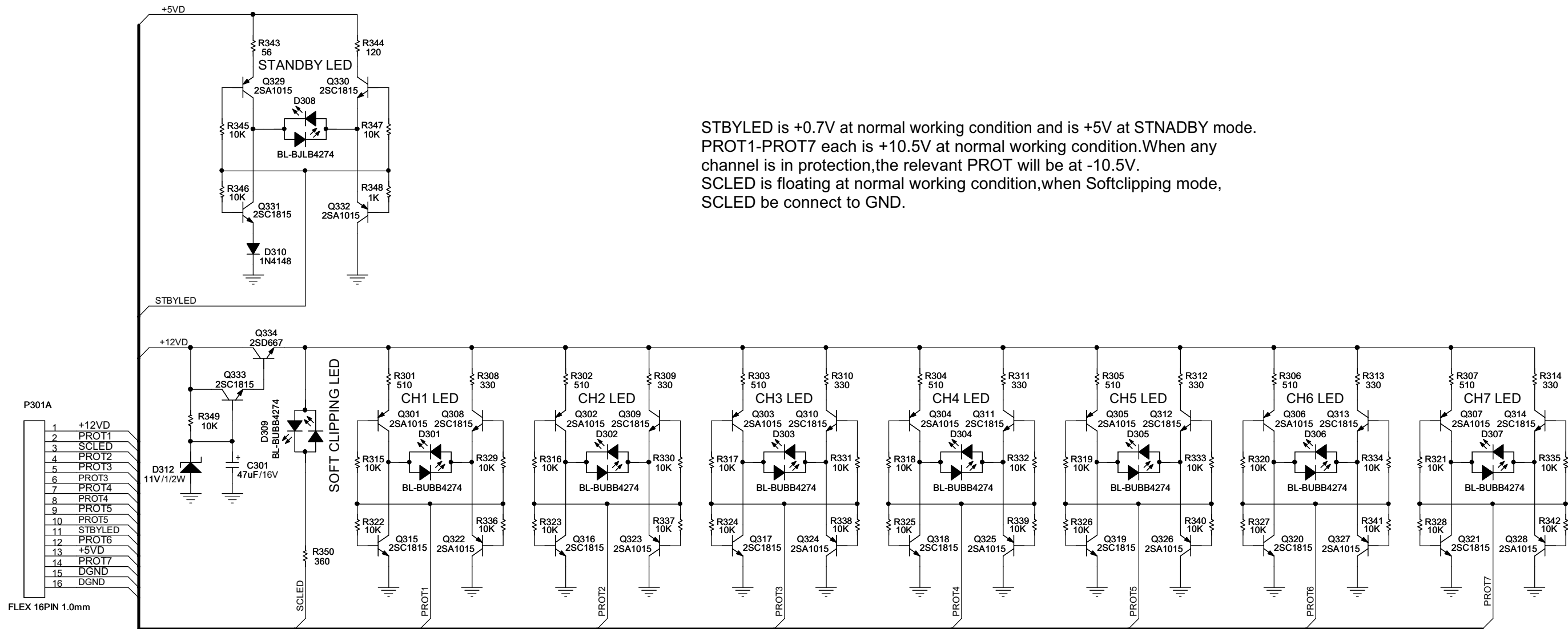

All Polyester capacitors are 63V unless noted.
 All Elec. capacitors are 50V unless noted.
 All Resistor are 1/6W unless noted.

SCHEMATICS DIAGRAM-

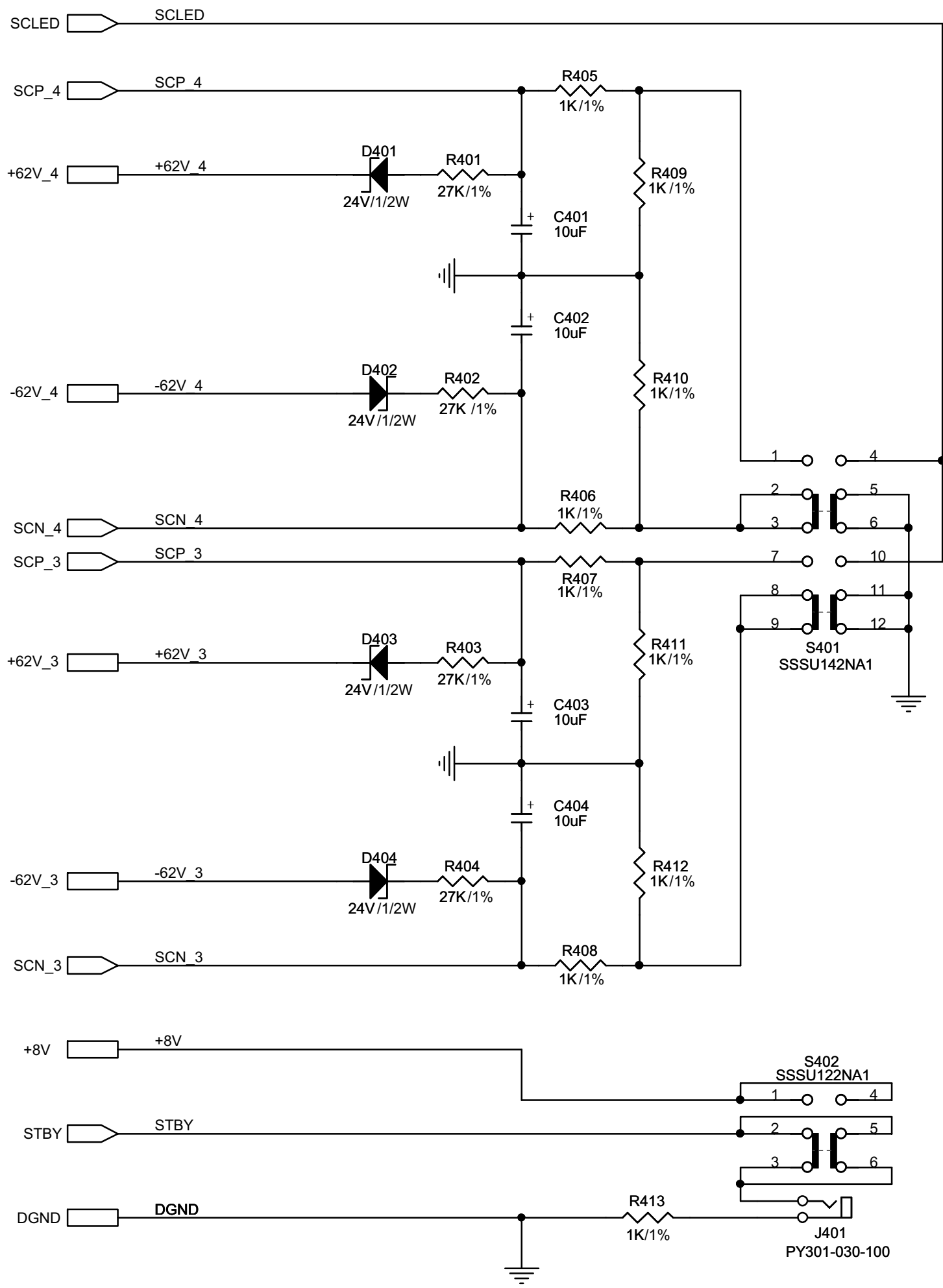

P401B

1	STBY
2	+8V
3	DGND
4	SCLED
5	SCN 3
6	SCN 4
7	SCP 3
8	SCP 4
9	+62V 3
10	-62V 3
11	+62V 4
12	-62V 4

12PIN2.0-C

All Polyester capacitors are 63V unless noted.
 All Elec. capacitors are 50V unless noted.
 All Resistor are 1/6W unless noted.

SCHEMATICS DIAGRAM

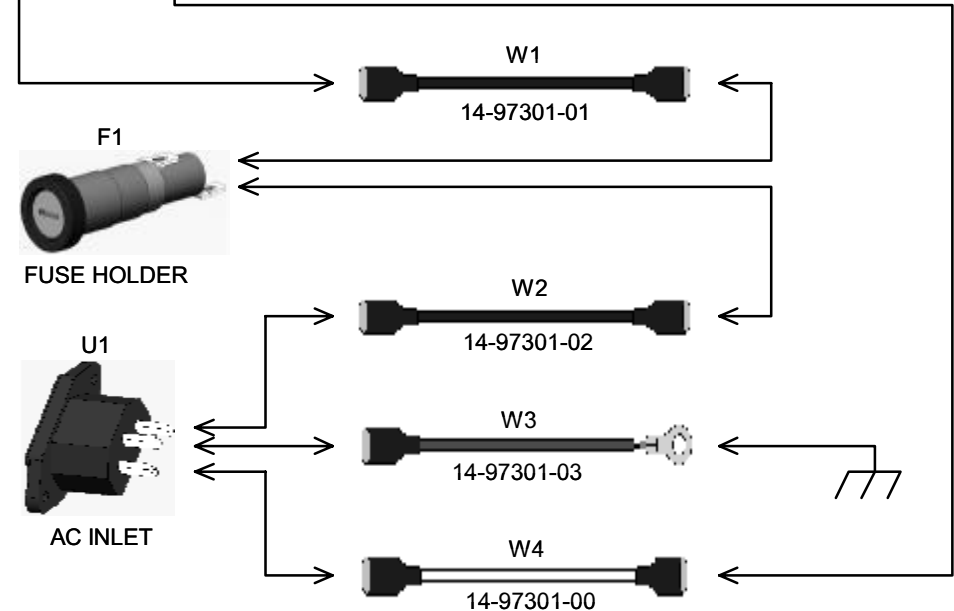
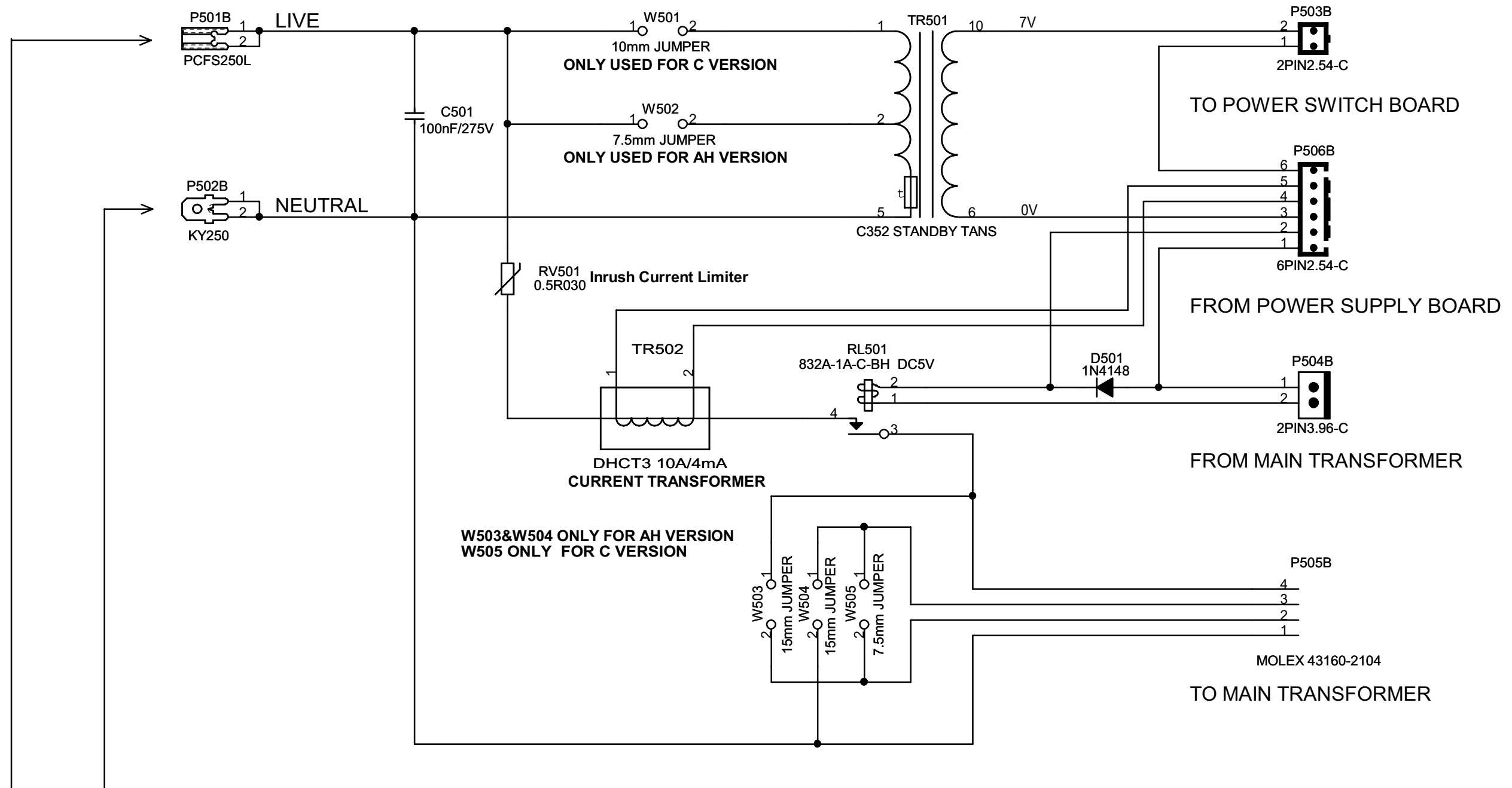

M25 120V/230V TABLE		
	120V	230V
W501&W505	NO INSERT	INSERT
W502,W503&W504	INSERT	NO INSERT
F1 (user accessible fuse)	T20AL/250V	T10AL/250V

SCHEMATICS DIAGRAM

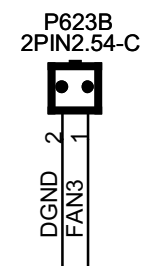
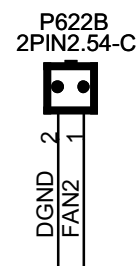
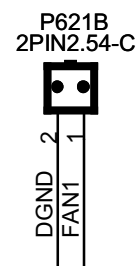
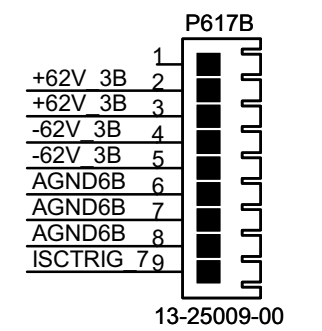
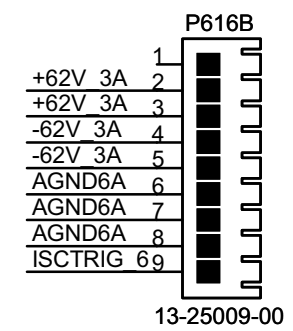
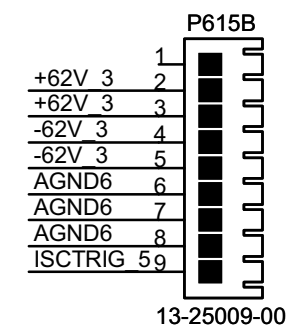
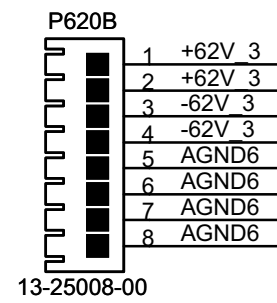
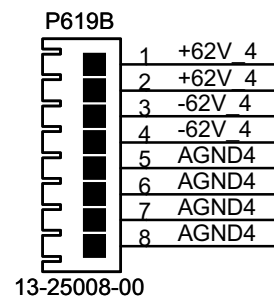
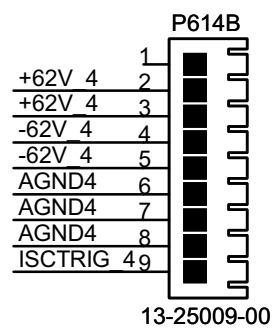
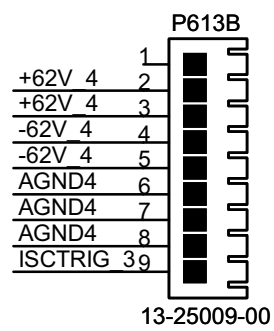
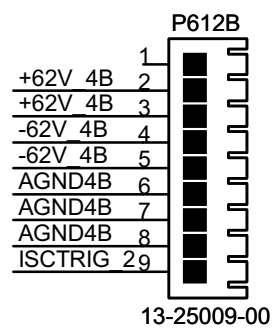
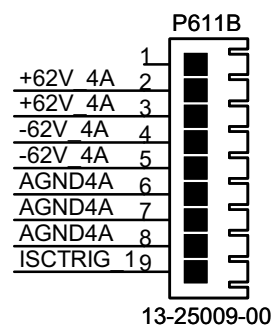
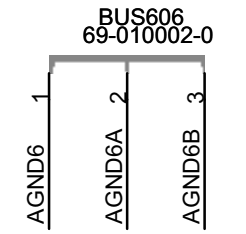
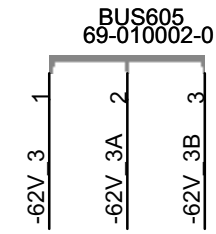
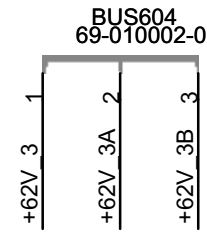
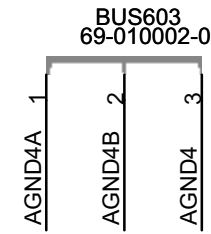
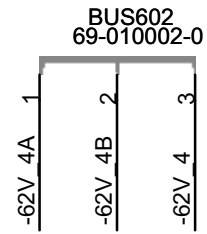
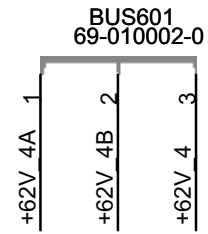
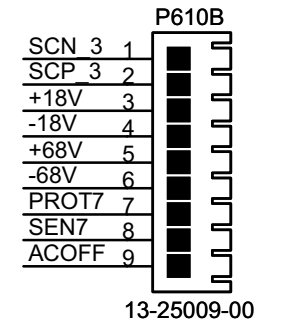
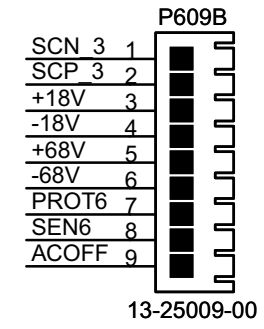
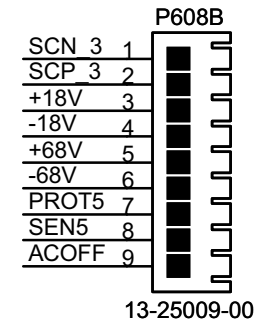
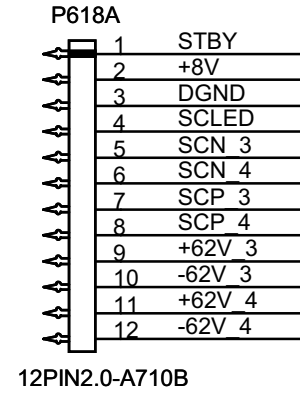
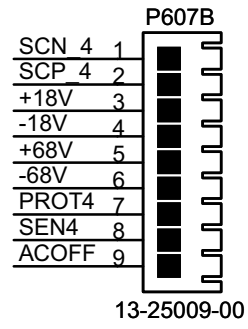
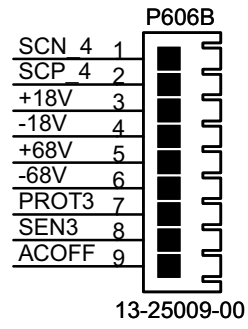
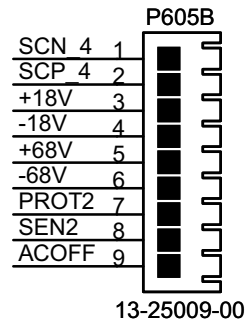
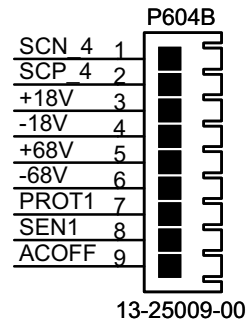
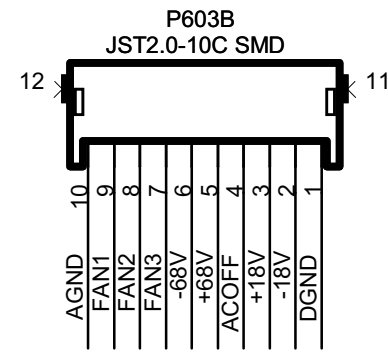
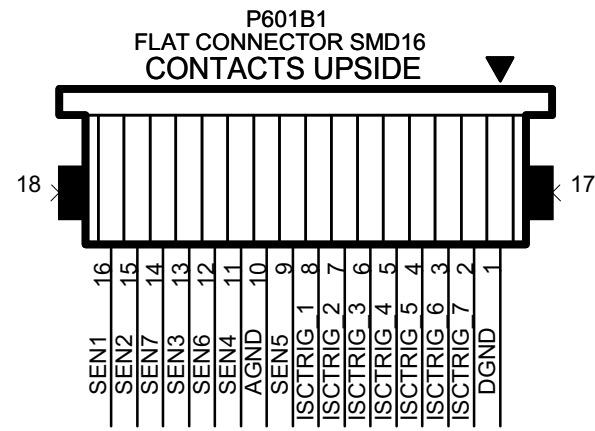
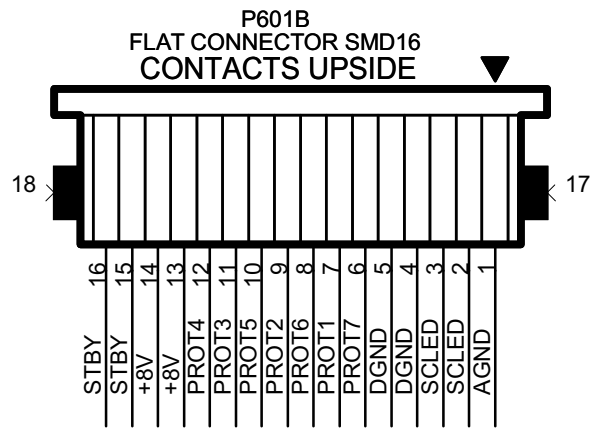

SCHEMATICS DIAGRAM

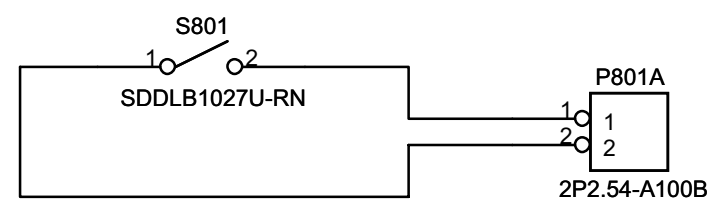

SCHEMATICS DIAGRAM

Primary leads are terminated with Molex 43375-0001 and with Molex housing 44441-2004

Secondary leads are terminated with Molex 43375-0001 and with Molex housing 44441-2005

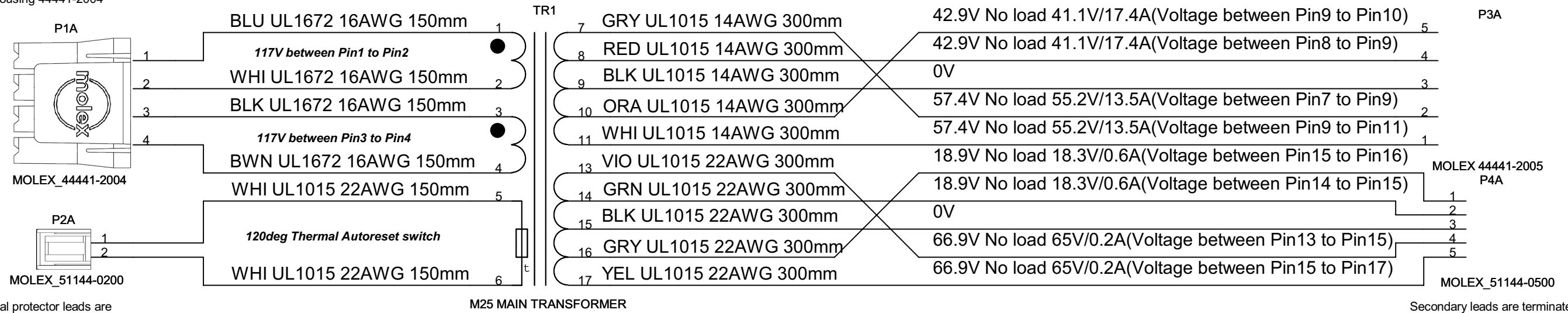

Thermal protector leads are terminated with Molex 50539-8000 and with Molex housing 51144-0200

Secondary leads are terminated with Molex 50539-8000 and with Molex housing 51144-0500

<p>Secondary high and low Alternative loads Secondary current at normal load Thermal protector mounted on secondary side but leads close to primary leads</p> <p>Diameter <162mm Center filled and 10mm hole Height <106mm Weight <10.8Kg</p> <p>Comments: 1)Primary resistance:2x0.36ohm 2)Secondary resistance:2x(0.065+0.03) and 2x(1.1+0.44)ohm 3)Calculated temperature rise at 1350VA continuous load:77 deg C 4)CUL recognized to UL6500 and Can/CSA E60065-00</p>	<p>Label: ⌈</p> <p>Toroid Audio Ltd P/N: TI-043810 AU Iss 2 NAD: M25 Thermal Autoreset 120Deg Class B insulation system (E202144/Z125) cULus logo + E115159 CE Logo</p> <p>⌋</p>
--	--

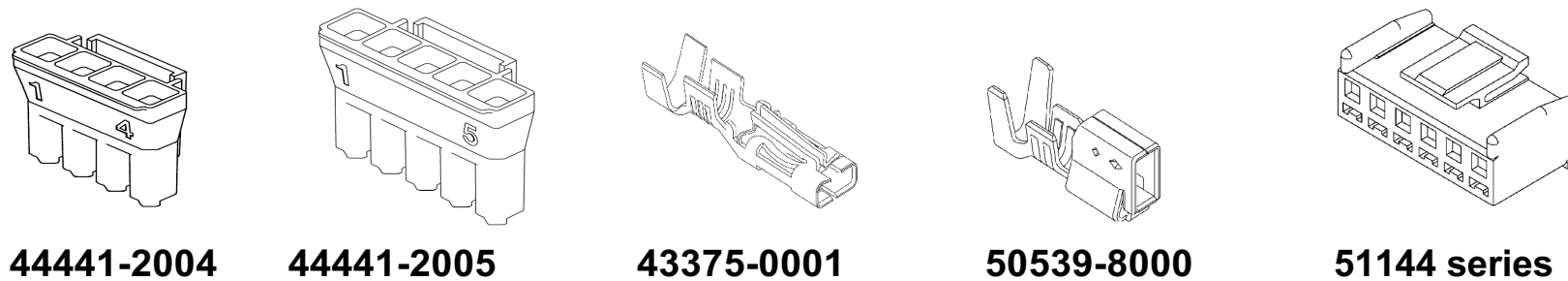

44441-2004

44441-2005

43375-0001

50539-8000

51144 series