

# Nakamichi BX-100

2 Head Cassette Deck

Owner's Manual



**CAUTION**  
RISK OF ELECTRIC SHOCK. DONTOPEN!

**CAUTION**

TO REDUCE THE RISK OF ELECTRIC SHOCK, DO NOT REMOVE COVER (OR BACK). NO USER-SERVICEABLE PARTS INSIDE. REFER SERVICING TO QUALIFIED SERVICE PERSONNEL.

The lightning flash with arrowhead symbol, within an equilateral triangle, is intended to alert the user of the presence of uninsulated "dangerous voltage" within the product's enclosure; that may be of sufficient magnitude to constitute a risk of electric shock to persons.

The exclamation point within an equilateral triangle is intended to alert the user of the presence of important operating and maintenance (servicing) instructions, in the literature accompanying the appliance.

**WARNING**

TO PREVENT FIRE OR SHOCK HAZARD, DO NOT EXPOSE THIS APPLIANCE TO RAIN OR MOISTURE.

This equipment generates and uses radio frequency energy and if not installed and used properly, that is, in strict accordance with the manufacturer's instructions, may cause interference to radio and television reception. It has been type tested and found to comply with the limits for a Class B computing device in accordance with the specifications in Subpart J of Part 15 of FCC Rules, which are designed to provide reasonable protection against such interference in a residential installation.

However, there is no guarantee that interference will not occur in a particular installation. If this equipment does cause interference to radio or television reception, which can be determined by turning the equipment off and on, the user is encouraged to try to correct the interference by one or more of the following measures:

- reorient the receiving antenna
- relocate this equipment with respect to the receiver
- move this equipment away from the receiver
- plug this equipment into a different outlet so that equipment and receiver are on different branch circuits.

If necessary, the user should consult the dealer or an experienced radio/television technician for additional suggestions. The user may find the following booklet prepared by the Federal Communications Commission helpful: "How to Identify and Resolve Radio-TV Interference Problems".

This booklet is available from the U.S. Government Printing Office, Washington, DC 20402, Stock No. 004-000-00345-4.

Congratulations!

You have chosen a very fine cassette deck. This model was developed on the basis of Nakamichi's extensive experience with high-grade cassette decks. Incorporating much of their superior technology and sound policy, this basic model delivers high overall characteristics and represents an extraordinary value at a moderate price.

Please take the time to read this manual in its entirety to fully acquaint yourself with this cassette deck.

Thank you.

Nakamichi Corporation.

Please record the Model Number and Serial Number in the space provided below and retain these numbers. Model Number and Serial Number are located on the rear panel of the unit. Model Number: Nakamichi BX-100 Serial Number: \_\_\_\_\_

**CONTENTS**

Connections .....	2
Safety Instructions.....	3
On Cassette Tapes .....	3
Controls and Features .....	4
Operation .....	5
Auto Repeat Playback .....	6
Maintenance .....	6
Troubleshooting.....	7
Specifications.....	8
Optional Accessories .....	8

**Connections**

After consulting the instructions for your amplifier or receiver, use the shielded cables with RCA plugs (provided with the deck) to make connections as shown in the chart. Take care not to mix up left and right channels. While making connections, the power to the deck and to the amplifier should be switched off.

**Headphones**

Standard stereo headphones with an impedance of 8~150 ohms may be connected to the headphone jack.

**Microphone Connections**

The BX-100 possesses only line facilities. When microphones are to be used for recording, a separate microphone mixer with a line output must be connected to this deck's line input terminals. Nakamichi offers the optional MX-100 Microphone Mixer, which provides three inputs for left, right and center blend (L+R) microphones. To power the MX-100, the separate PS-100 Power Supply is required.

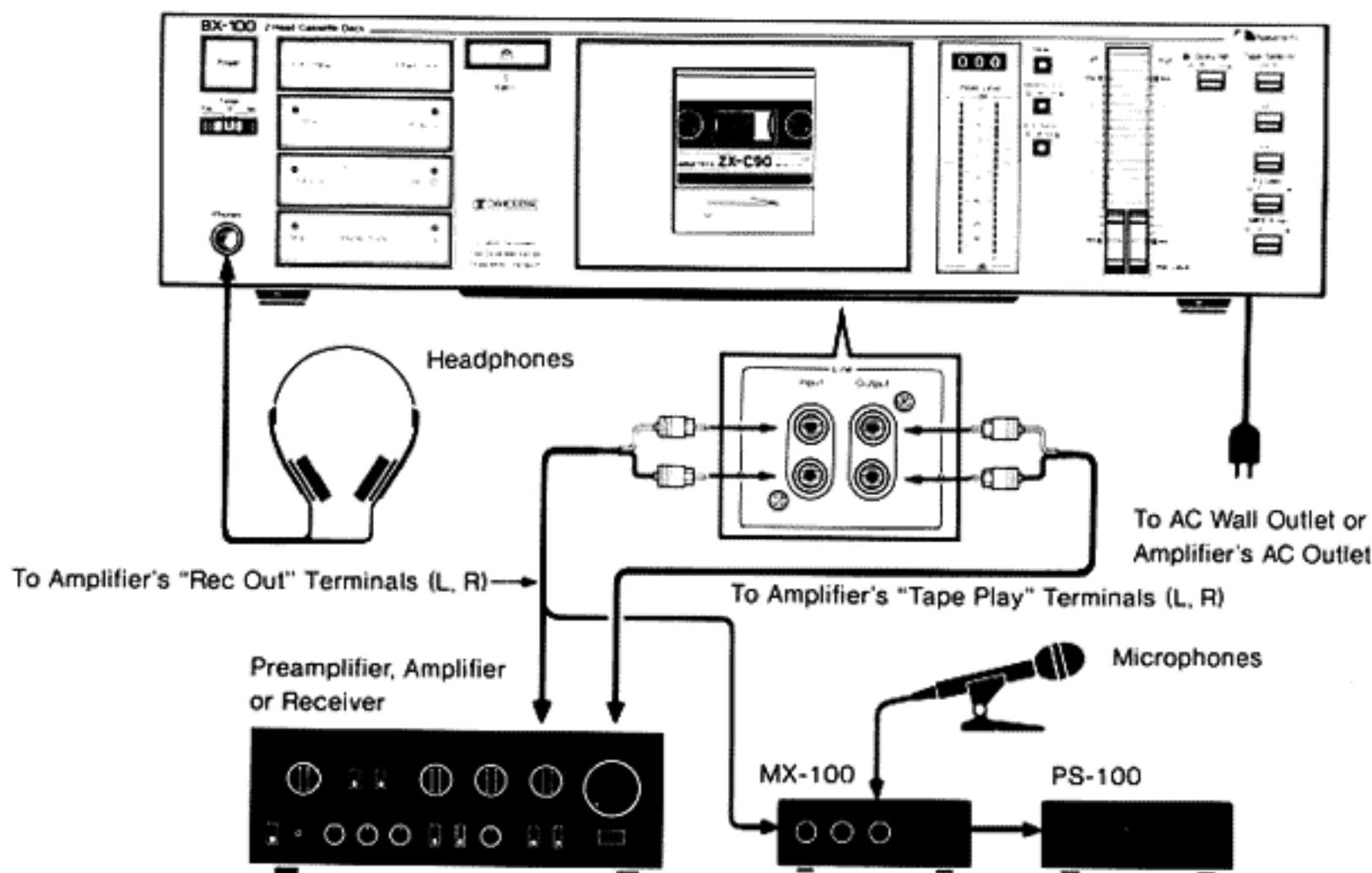

# Safety Instructions

The following safety instructions have been included in compliance with safety standard regulations. Please read them carefully.

1. Read Instructions—All the safety and operating instructions should be read before the appliance is operated.
2. Retain instructions—The safety and operating instructions should be retained for future reference.
3. Heed Warnings—All warnings on the appliance and in the operating instructions should be adhered.
4. Follow Instructions—All operating and use instructions should be followed.
5. Water and Moisture—The appliance should not be used near water—for example, near a bathtub, washbowl, kitchen sink, laundry tub, in a wet basement, or near a swimming pool, etc.
6. Carts and Stands—The appliance should be used only with a cart or stand that is recommended by the manufacturer.
7. Wall or Ceiling Mounting—The appliance should be mounted to a wall or ceiling only as recommended by the manufacturer.
8. Ventilation—The appliance should be situated so that its location or position does not interfere with its proper ventilation. For example, the appliance should not be situated on a bed, sofa, rug or similar surface that may block the ventilation openings; or placed in a built-in installation, such as a bookcase or cabinet that may impede the flow of air through the ventilation openings.
9. Heat—The appliance should be situated away from heat sources such as radiators, heat registers, stoves, or other appliances (including amplifiers) which produce heat.
10. Power Sources—The appliance should be connected to a power supply only of the type described in the operating instructions or as marked on the appliance.
11. Grounding or Polarization—Precautions should be taken so that the grounding or polarization means of an appliance is not defeated.
12. Power-Cord Protection—Power-supply cords should be routed so that they are not likely to be walked on or pinched by items placed upon or against them, paying particular attention to cords at plugs, convenience receptacles, and the point where they exit from the appliance.
13. Cleaning—The appliance should be cleaned only as recommended by the manufacturer.
14. Nonuse Periods—The power cord of the appliance should be unplugged from the outlet when left unused for a long period of time.
15. Object and Liquid Entry—Care should be taken so that objects do not fall and liquids are not spilled into the enclosure through openings.
16. Damage Requiring Service—The appliance should be serviced by qualified service personnel when:
  - A. The power-supply cord or the plug has been damaged; or,
  - B. Objects have fallen, or liquid has been spilled into the appliance; or,
  - C. The appliance has been exposed to rain; or,
  - D. The appliance does not appear to operate normally or exhibits a marked change in performance; or,
  - E. The appliance has been dropped, or the enclosure damaged.
17. Servicing—The user should not attempt to service the appliance beyond that described in the operating instruction. All other servicing should be referred to qualified service personnel.

## On Cassette Tapes

### Precautions

1. C-120 cassettes (playing time one hour per side) contain extremely thin tape which breaks or snarls easily, is sometimes subject to stretching and also is of low sensitivity. Therefore, C-120 cassettes are not recommended for high-fidelity recording.
2. Do not pull out the tape from the cassette housing.
3. Be careful not to turn the cassette reels with the fingers, causing tape slackening.
4. Store cassette tapes away from heat, high humidity, dust, and magnetic fields such as caused by speakers, TV sets etc.

### Cassette Tabs

You can protect valuable recordings from accidental erasure and re-recording by completely removing the appropriate tab on the top edge of the cassette. The tab for each side is located on the top left-hand corner as you face the side. Use a small screwdriver, and push the tab down to break it off. Do not leave the broken tab in the recess. If you wish at a later date to record over a side for which the

tab has been removed, cover the tab opening with a piece of adhesive tape.

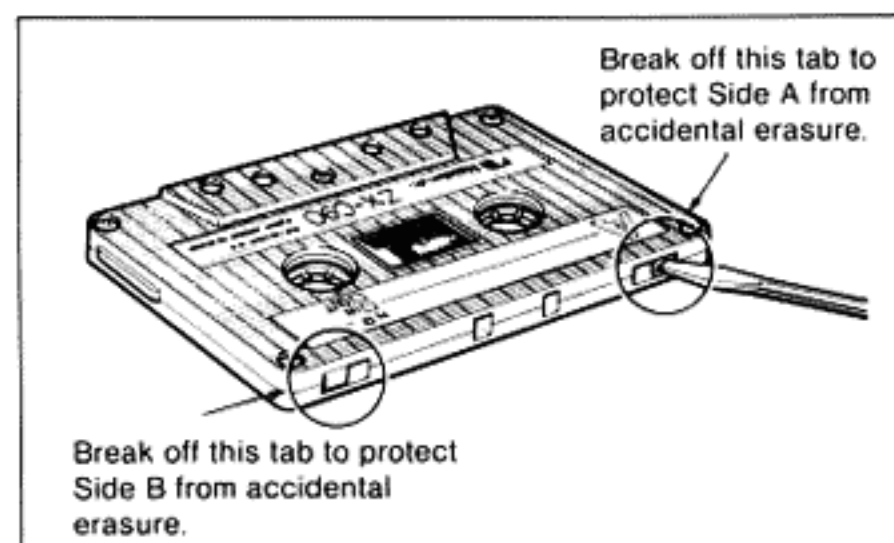

### Cassette Insertion and Removal

#### (1) Insertion of a Cassette

1. When the Eject button is pushed in the stop mode, the cassette holder opens.
  2. Insert the cassette into the holder with the exposed tape facing down and the label of the desired side facing you.
  3. Gently push the cassette holder back into the panel.
- For protection of the tape and tape transport, do not press the Eject button in any mode other than the stop mode.

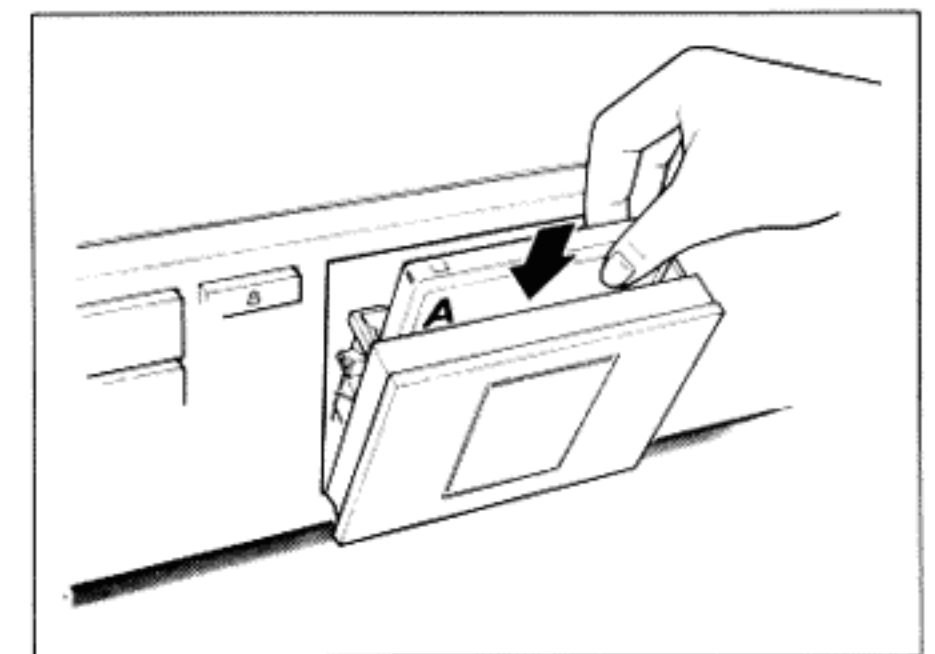

#### (2) Removal of a Cassette

1. Press the Stop button.
2. When the eject button is pushed, the cassette holder opens.
3. Remove the cassette.



# Controls and Features

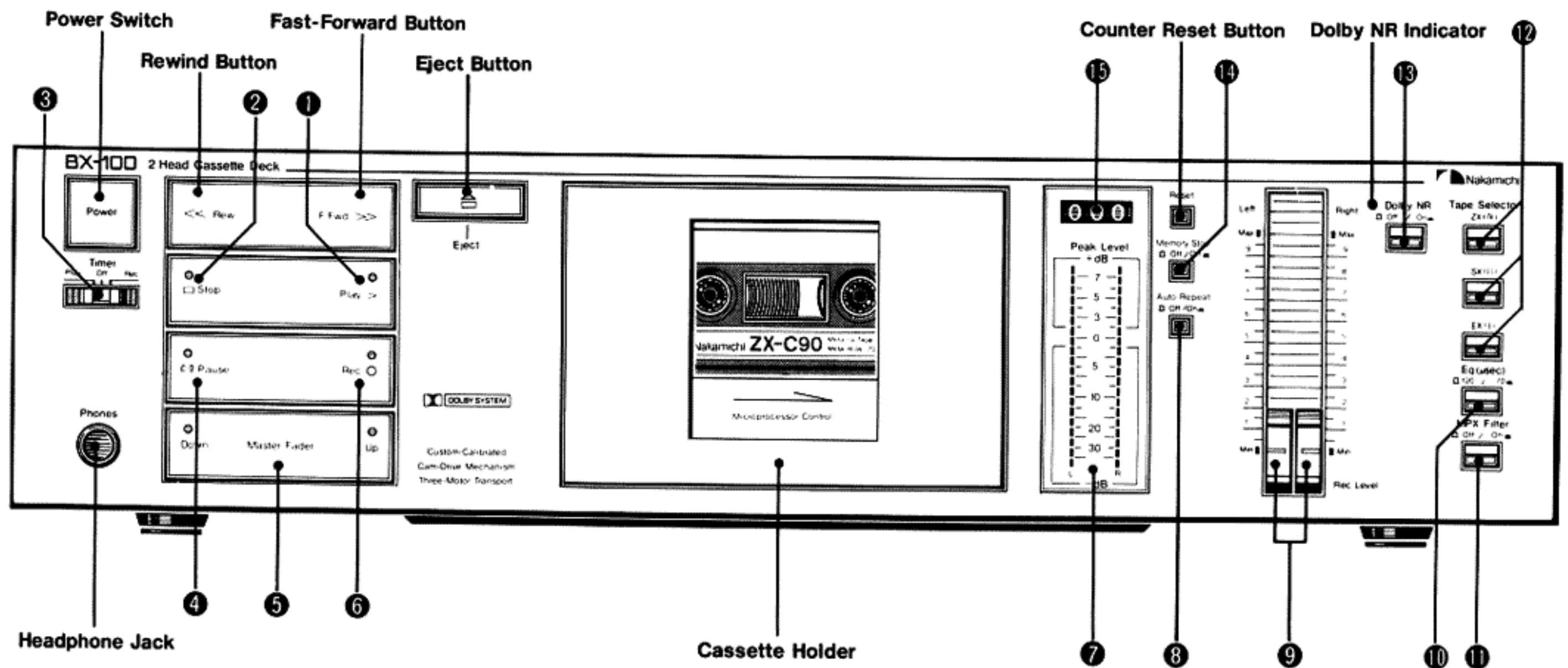

## (1) Play Button

To start playback of a tape or start recording from the record-standby mode, press the section marked with  $\triangleright$ . During operation, the indicator lights up.

## (2) Stop Button

When the section marked with  $\square$  is pressed, tape motion comes to a full stop and the indicator lights up.

## (3) Timer Switch

This switch is used for timer-activated recording or playback. In ordinary operation, it must be set to "Off". (→p. 5)

## (4) Pause Button

When the section marked with  $\square\square$  is pressed during recording or playback, tape motion is interrupted and the indicator lights up. To restart the tape, press the Play button.

## (5) Master Fader Button

This button is used to perform fade-in or fade-out during recording. (→p. 5)

## (6) Record Button

Simply by pressing the section marked with  $\circ$ , the record-standby mode is entered, and the indicator lights up.

## (7) Peak Level Meters

Provide exact indication of peak levels in the range of  $-30$  dB to  $+7$  dB.

## (8) Auto Repeat Switch

By setting this switch to "On", auto repeat playback is performed. (→p. 6)

## (9) Input Level Controls

Serve to adjust the recording level for left and right channels.

## (10) Equalizer Switch

Serves to set the correct equalization in recording and playback for the tape in use. (→p. 5)

## (11) MPX Filter Switch

Used to suppress the 19-kHz multiplex carrier signal, which could interfere with proper Dolby NR operation when recording from FM stereo broadcasts. When recording from other sources or during playback, this switch should be set to "Off".

## (12) Tape Selector Switches

In recording, the correct switch must be pressed for the tape in use. (→p. 5)

## (13) Dolby NR Switch

To use the Dolby noise reduction system (B-type), set this switch to "On".

## (14) Memory Switch

When this switch is set to "On", the tape automatically stops at the counter indication "000" during rewind.

## (15) Tape Counter

Indicates tape travel, starting from "000". By pressing the counter reset button, the counter is reset to "000".

## Precautions Before Operation

- (1) This deck incorporates a muting circuit which is active for about 4 seconds after the power was switched on, until all circuits have become stable.
- (2) If the power is switched on while the Timer switch is set to "Rec" or "Play", recording or playback will start automatically. In order to prevent accidental erasure of a tape, be sure to set the Timer switch to "Off" when the timer function is not desired.
- (3) If during playback or recording the power to the deck was switched off by an external timer or the like, it may afterwards not be possible to depress the Eject button. Do not apply excessive force in such a case. Set the Timer switch of the

deck to "Off", and then switch the power to the deck back on. The cassette can now be removed.

## (4) Voltage Selector

AC voltage is factory-set for the country in which you purchased your cassette deck. The voltage selector permits re-setting of mains voltage in case the deck is to be used in a different country.

### Note:

Safety regulations in certain countries prohibit inclusion of a voltage selector. This feature, therefore, may be absent from your deck.

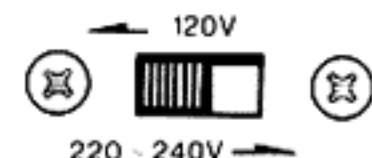

# Operation

## Playback

- (1) Set the Equalizer switch to the required position for the tape in use.
- (2) Set the Dolby NR switch to the same position as used for recording.
- (3) Press the Play button.
- (4) Adjust the amplifier's volume control to the desired listening level.

- With this deck you can go from any mode into any other (for example from playback to rewind, from rewind to fast-forward, etc.) without having to press the Stop button.

## Recording

- (1) Set the Tape Selector switches and the Equalizer switch to the required positions for the tape in use.
- (2) Select the desired position of the Dolby NR switch. For recording from FM broadcasts, set the MPX Filter switch to "On".
- (3) Simply press the Rec button to set the deck to the record-standby (Rec/Pause) mode.
- (4) Set the recording level with the Input Level controls, while watching the indication of the Peak Level meters.
- (5) Press the Play button to start recording. To temporarily stop the tape while remaining in the record-standby mode, press the Pause button. To resume recording, press the Play button once more.

### Master Fader

This feature permits smooth and easy fades during recording without having to move the Input Level control. By pressing the "Down" section of the Master Fader button, the recording level is gradually reduced to zero. After the level was reduced by pressing "Down", pressing the "Up" section will automatically raise it again to the previous setting.

You can choose between two fading speeds: By keeping "Up" or "Down" depressed, fading is performed in about 2 seconds. By depressing the button once and then releasing it, fading takes about 4 seconds. The respective fading mode is indicated by the brightness of the indicators.

#### Note:

- The operation of the fader control can be changed from "Up" to "Down" or from "Down" to "Up", but it cannot be stopped midway.
- The Master Fader is operative only in the record and record-standby modes. When these modes are released, the setting automatically becomes "Up".

## Dolby NR System

This deck incorporates the Dolby NR system (B-type), which provides approximately 10 dB of noise reduction in the high frequencies. To use this system in recording, set the Dolby NR switch to "On". When playing back tapes from your collection which were recorded with the Dolby B-type NR system, always set this switch to "On".

## Record Level Setting

For good recordings, it is essential to maintain a high signal-to-noise ratio. If the record level is set too low, tape hiss will impair the playback sound quality. If it is set too high, the tape will be driven into distortion. Refer to the chart below to set recording levels.

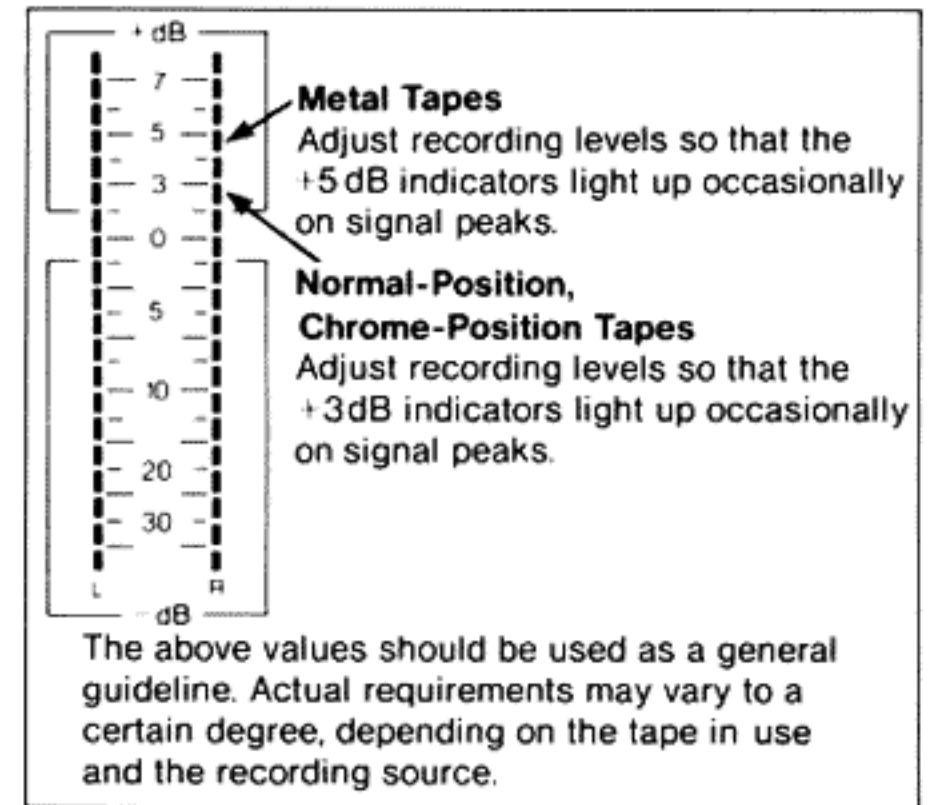

## Tape Selector and Equalizer Switch Setting Chart

This cassette deck was calibrated at the factory with Nakamichi reference tapes. To obtain optimum results and fully realize this deck's potential, the use of Nakamichi tapes is

recommended. When using other tapes, you should choose tapes from the list, whenever possible.

Tape Selector	Eq ( $\mu$ sec)	Brand/Designation
Normal Position TYPE EX( I )	120 $\mu$ SEC	Nakamichi EX, EX II AMPEX GM-I Fuji FR I Maxell UD, UD-XL I, XL I-S TDK AD, AD-X, OD
Chrome (Cobalt) Position TYPE SX( II )	70 $\mu$ SEC	Nakamichi SX, SX II AMPEX GM-II Fuji FR II Maxell UD-XL II, XL II-S TDK SA, SA-X
Metal Position TYPE ZX( IV )	70 $\mu$ SEC	Nakamichi ZX AMPEX MPT Fuji FR Metal Maxell MX TDK MA, MA-R

## Timer Recording or Playback

- (1) Establish connections as shown in the chart, and switch on the power to all components.
- (2) For timer-activated recording, set the recording level to suit the expected signal. For timer-activated playback, set the amplifier's volume control to the desired listening level. Check if all components are set up properly.

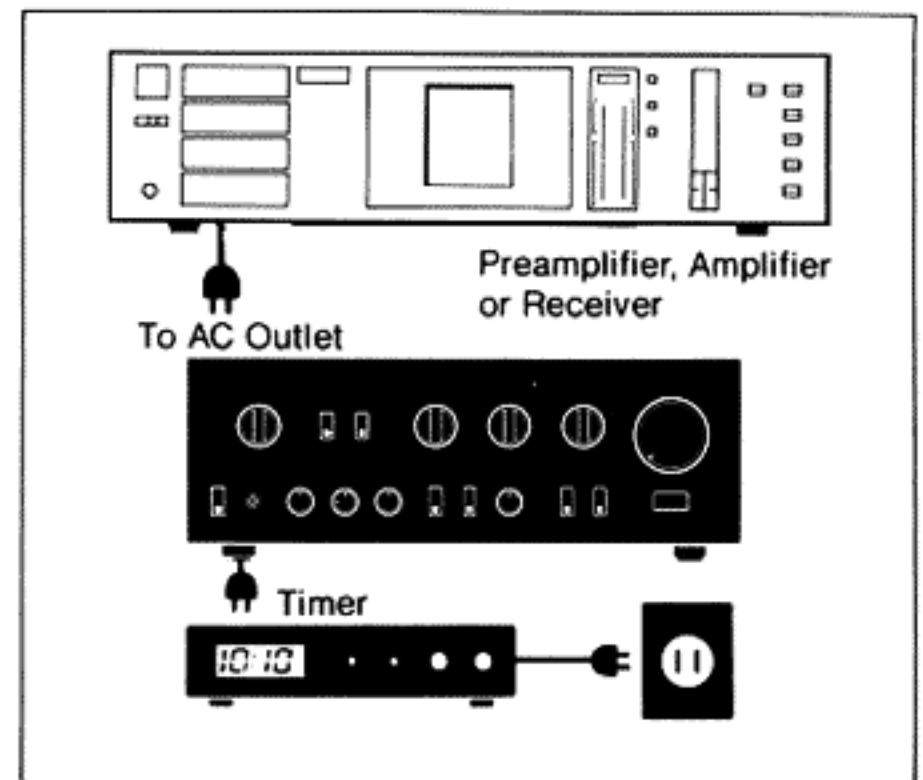



# Auto Repeat Playback

- (3) For timer-activated recording, set this deck's Timer switch to "Rec". For timer-activated playback, set the switch to "Play".
- (4) Set the timer to the desired operation time.
- (5) At the pre-selected time, the timer will supply power to the components, and recording or playback will start automatically.

**Notes:**

- Be sure to set this deck's Timer switch to "Off" when timer recording or playback is not to be carried out.
- If the record-protection tabs of the inserted cassette are removed, timer-activated recording is not possible and the deck will go into the stop mode.

## (1) Auto Repeat of One Complete Side

With the Auto Repeat switch set to "On", the following operating sequence is repeated when the tape end is reached during recording, playback or fast-forward:

**automatic rewind to the tape start → playback from the beginning → automatic rewind when tape end is reached → playback from the beginning....**

Repeat playback will also be performed if the beginning of the tape is reached in rewind.

## (2) Auto Repeat Between Tape Counter "000" and Tape End

The auto repeat function can also be used in conjunction with the Memory switch. When the Auto Repeat switch and the Memory switch are both set to "On", auto repeat will be performed **between the tape counter "000" indication and the tape end.**

- When the Timer switch is set to "Rec" or "Play", the auto repeat function is inoperative.

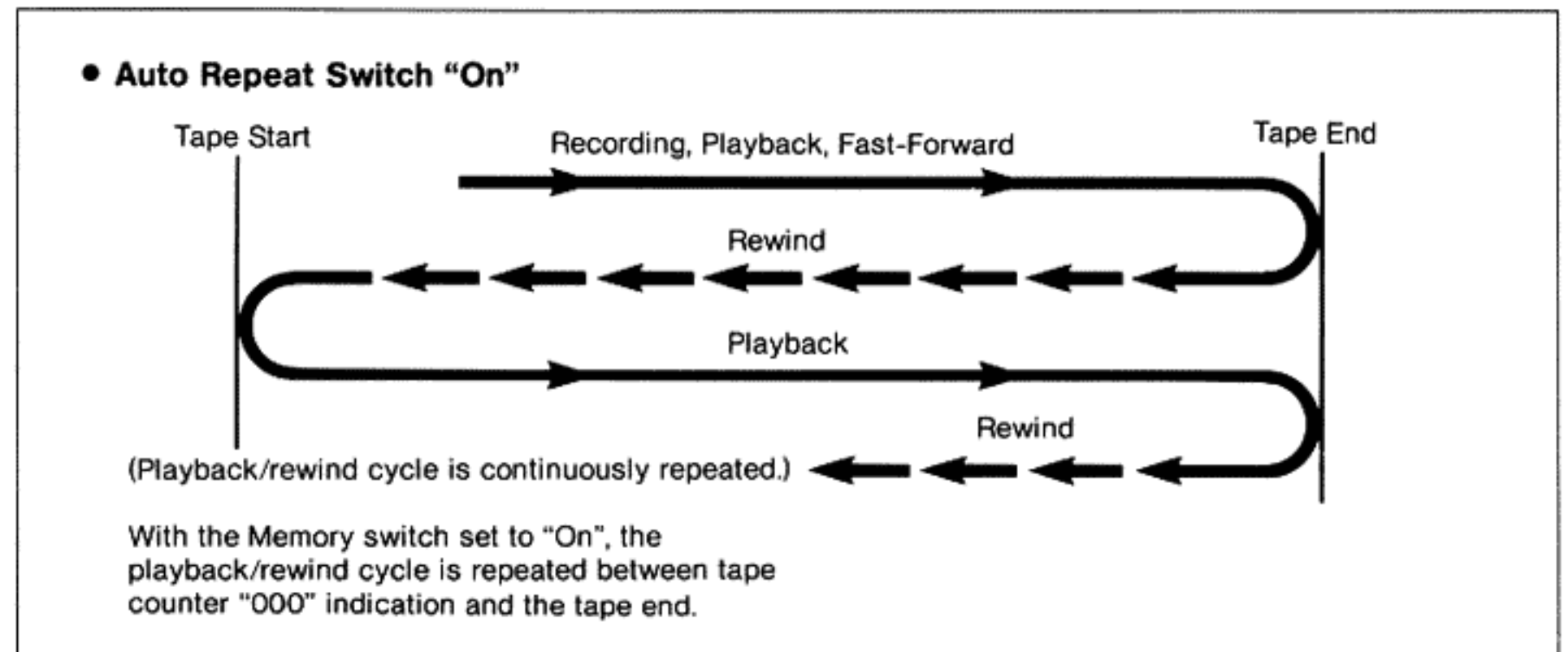

# Maintenance

## Cleaning

It is very important to regularly clean the head surfaces and transport section, etc. Contamination caused by tiny particles shedded from the tape onto these parts can become the cause of drop-outs and severely degrade high-frequency response and wow-and-flutter characteristics. Perform cleaning as follows.

- (1) Remove the cassette holder cover and push the cassette holder back in.

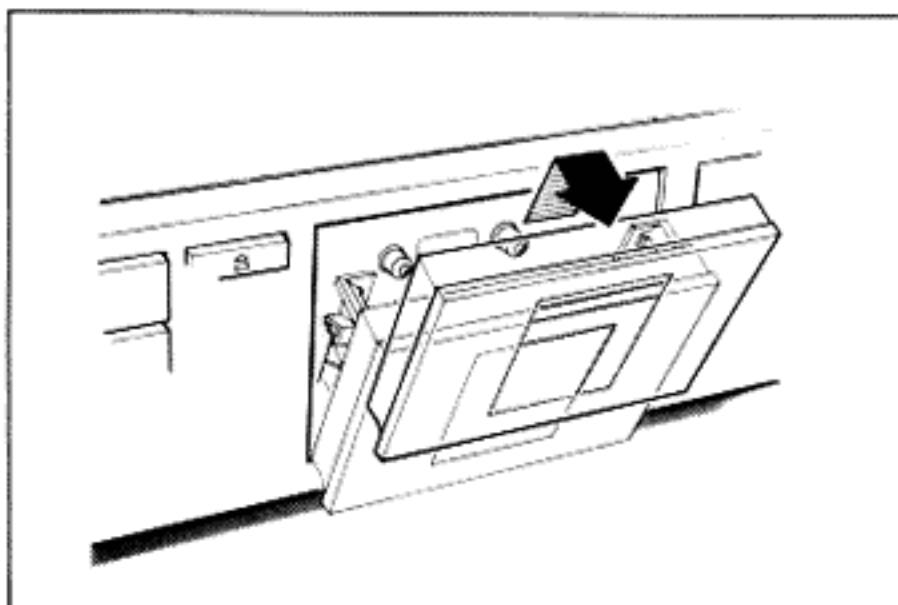

- (2) Press the Play button and clean the revolving pressure roller by holding a cotton-tipped stick lightly against the roller on the side turning away from the capstan.

Be careful that the cotton tip does not get caught between the roller and the capstan.

- (3) Press the Pause button to release the pressure roller from the capstan. Now clean the capstan and the surfaces of the heads and tape guides with a cotton-tipped stick. Be careful not to apply too much force. Take special care not to damage the tape guides.

- After cleaning, make sure that no cotton strands are left on any of the cleaned parts.
- In case of severe contamination, moisten the cotton tip with a small amount of commercially available cleaning fluid especially designed for this purpose.

After cleaning with a cleaning fluid, wait until any residue has completely dried off before playing a tape.

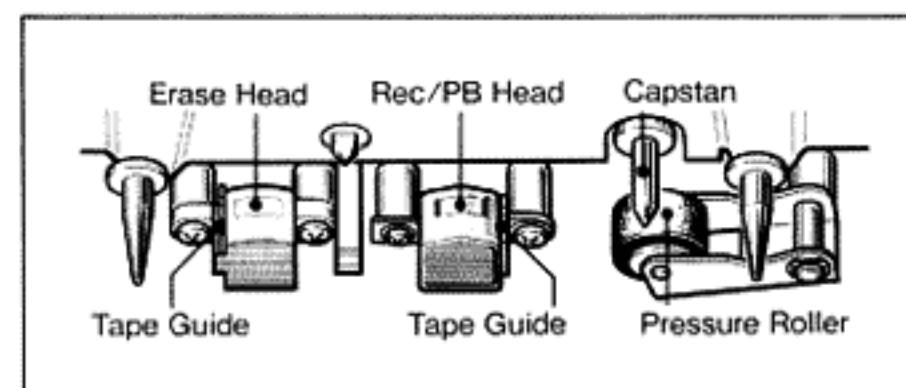

## Demagnetizing

After a longer period of use, there can be a build-up of residual magnetism in the heads and capstan. Such residual magnetism can induce noise and partially erase the high frequencies of a tape being played. To prevent this, you should demagnetize these parts about once every 50 hours of use with the Nakamichi DM-10 Demagnetizer (optional) or any other properly designed demagnetizer. For details, refer to the instruction manual of the demagnetizer.

## Lubrication

All important moving parts this cassette deck are fitted with long-life, oil-less bearings. Periodic lubrication is therefore not necessary.

## Cleaning the Faceplate

Clean the faceplate only by wiping it with a soft, dry cloth. Never use alcohol, solvents, ammonia or abrasive cleaning agents.

# Troubleshooting

Condition	Probable Cause	Remedy
Tape does not run.	<ol style="list-style-type: none"> <li>1. Power cord is unplugged.</li> <li>2. Cassette holder not completely locked.</li> </ol>	<ol style="list-style-type: none"> <li>1. Plug in cord firmly.</li> <li>2. Press eject button and then close cassette holder firmly.</li> </ol>
Record mode cannot be entered.	<ol style="list-style-type: none"> <li>3. No cassette inserted.</li> <li>4. Cassette tabs have been removed.</li> </ol>	<ol style="list-style-type: none"> <li>3. Insert cassette tape.</li> <li>4. Place adhesive tape over tab opening or use new cassette.</li> </ol>
Excessive playback hiss.	<ol style="list-style-type: none"> <li>5. Head is magnetized.</li> </ol>	<ol style="list-style-type: none"> <li>5. Demagnetize head.</li> </ol>
Uneven sound levels, drop-outs, excessive wow/flutter	<ol style="list-style-type: none"> <li>6. Head and/or capstan and pressure roller dirty.</li> <li>7. Faulty cassette.</li> </ol>	<ol style="list-style-type: none"> <li>6. Clean these parts.</li> <li>7. Replace cassette.</li> </ol>
Incomplete erasure.	<ol style="list-style-type: none"> <li>8. Erase head dirty.</li> </ol>	<ol style="list-style-type: none"> <li>8. Clean head and pressure roller.</li> </ol>
Distorted record/playback sound.	<ol style="list-style-type: none"> <li>9. Program material itself is distorted.</li> <li>10. Recording levels are too high.</li> <li>11. Head dirty.</li> <li>12. Wrong setting of tape selector switch.</li> </ol>	<ol style="list-style-type: none"> <li>9. Check program material.</li> <li>10. Wide dynamic range permits some short-term overload, but excessive recording levels will cause distortion. Adjust recording levels.</li> <li>11. Clean head.</li> <li>12. Select correct setting for tape in use.</li> </ol>
Record mode is entered, but cannot record.	<ol style="list-style-type: none"> <li>13. Input disconnected.</li> <li>14. Head dirty.</li> <li>15. Master fader control is set to down.</li> </ol>	<ol style="list-style-type: none"> <li>13. Check connections.</li> <li>14. Clean head.</li> <li>15. Push the "Up" side of the master fader button.</li> </ol>
Cannot playback.	<ol style="list-style-type: none"> <li>16. Output disconnected.</li> <li>17. Head dirty.</li> </ol>	<ol style="list-style-type: none"> <li>16. Check connections.</li> <li>17. Clean head.</li> </ol>
Dull high frequencies.	<ol style="list-style-type: none"> <li>18. Head dirty.</li> <li>19. Tape selector switch and/or equalizer switch not set correctly.</li> </ol>	<ol style="list-style-type: none"> <li>18. Clean head.</li> <li>19. Select correct positions for tape in use.</li> </ol>
Hum heard during recording or playback.	<ol style="list-style-type: none"> <li>20. Strong induction fields near deck.</li> <li>21. Signal cable or connector grounding faulty.</li> </ol>	<ol style="list-style-type: none"> <li>20. Keep deck away from amplifier, transformers, fluorescent lamps, etc.</li> <li>21. Replace signal cables.</li> </ol>

# Specifications

Track Configuration.....	4 tracks/2-channel stereo
Heads.....	2 (erase head x 1, record/playback head x 1)
Motors (Tape Transport).....	DC servo motor (capstan drive) x 1 DC motor (reel drive) x 1
Power Source.....	100, 120, 120/220-240, 220 or 240V AC; 50/60Hz (According to country of sale)
Power Consumption.....	23 W max.
Tape Speed.....	1-7/8 ips. (4.8 cm/sec.) ±0.5%
Wow-and-Flutter.....	Less than ±0.11% WTD Peak Less than 0.06% WTD RMS
Frequency Response.....	20 Hz-20,000 Hz (recording level - 20 dB)
Signal-to-Noise Ratio.....	<b>Dolby B-Type NR on</b> <70μs, ZX tape> Better than 62dB (400 Hz, 3% THD, IHF A-WTD RMS)
Total Harmonic Distortion.....	Less than 1.0% (400 Hz, 0 dB, ZX, EX II tape) Less than 1.2% (400 Hz, 0 dB, SX tape)
Erasure.....	Better than 60 dB (100 Hz, 0 dB)
Separation.....	Better than 36 dB (1 kHz, 0 dB)
Crosstalk.....	Better than 60 dB (1 kHz, 0 dB)
Bias Frequency.....	105 kHz
Input (Line).....	50 mV, 30 kΩ
Output (Line).....	0.5V (400 Hz, 0 dB) 2.2 kΩ
(Headphones).....	1.2 mW (400 Hz, 0 dB) 8 Ω load
Fast-Winding Time.....	Approx. 85 seconds (with C-60 cassette)
Dimensions.....	430(W) x 110(H) x 250(D) millimeters 16-15/16(W) x 4-5/16(H) x 9-7/8(D) inches
Approximate Weight.....	5.5 kg 12 lb. 2 oz

- Specifications and appearance design are subject to change for further improvement without notice.
- Noise Reduction System manufactured under license from Dolby Laboratories Licensing Corporation.
- The word "DOLBY" and the Double-D-Symbol are trademarks of Dolby Laboratories Licensing Corporation.

# Optional Accessories

ZX Metalloy Cassette Tape  
C-60, C-90  
SX II Super Ferricobalt Cassette Tape  
C-60, C-90  
SX Ferricobalt Cassette Tape  
C-60, C-90  
EX II Ferricrystal Cassette Tape  
C-60, C-90  
EX Ferrioxide Cassette Tape  
C-60, C-90

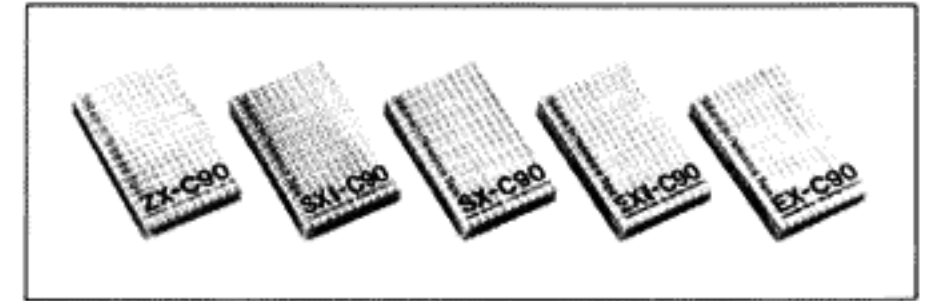

DM-10 Head Demagnetizer

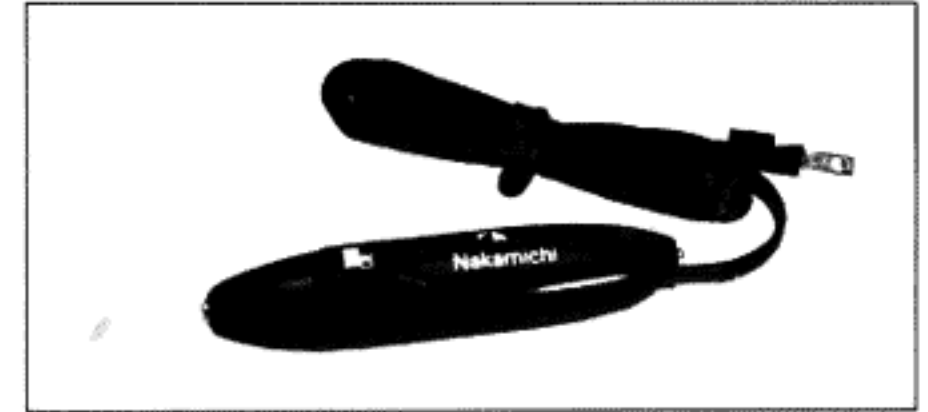

SF-10 Subsonic Filter

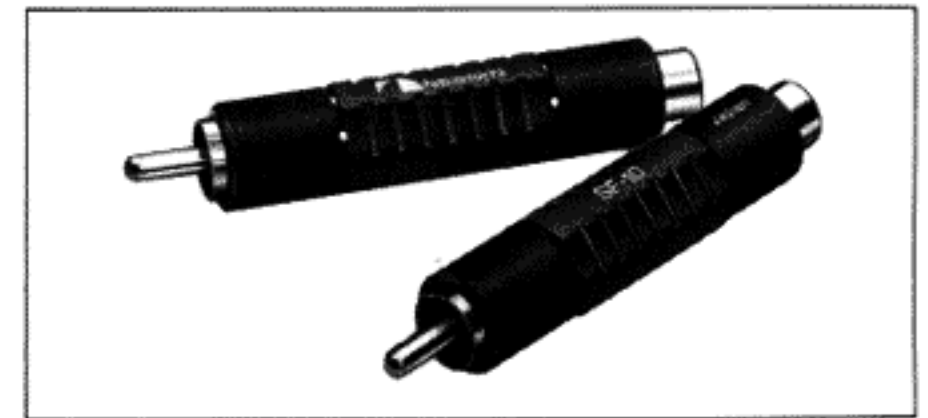

SP-7 Stereo Headphones

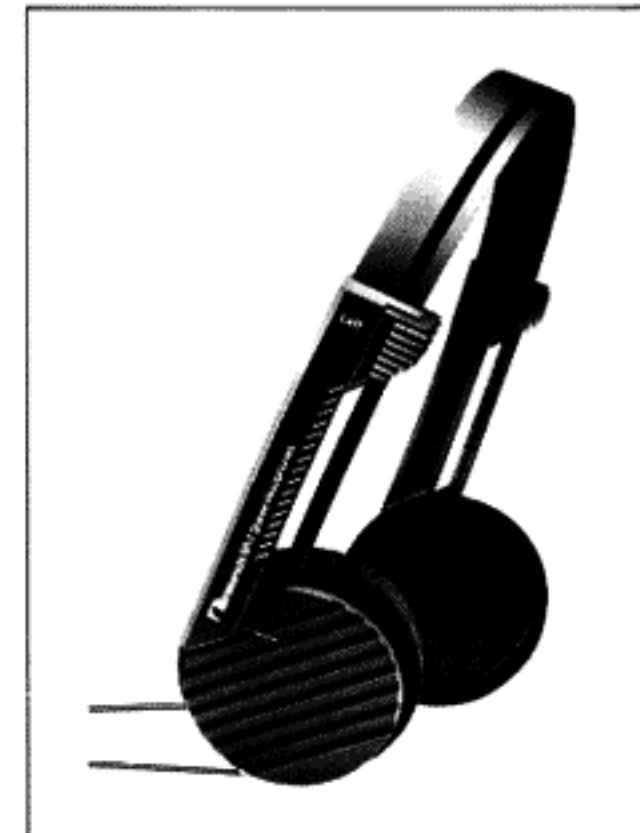

## Nakamichi Corporation

Tokyo Office  
Shinjuku Daiichi Seimei Bldg.  
2-7-1 Nishishinjuku, Shinjuku-ku, Tokyo  
Phone (03) 342-4461  
Telex : 2324721 (NAKAM J)

## Nakamichi U.S.A. Corporation

19701 South Vermont Avenue  
Torrance, California 90502  
Phone : (213) 538-8150  
Telex : 652429 (NAKREI SNM)

## Nakamichi GmbH

Stephanienstrasse 6, 4000 Düsseldorf 1  
Phone : (0211) 359036  
Telex : 8588834 (NAKA D)