

● Main Section

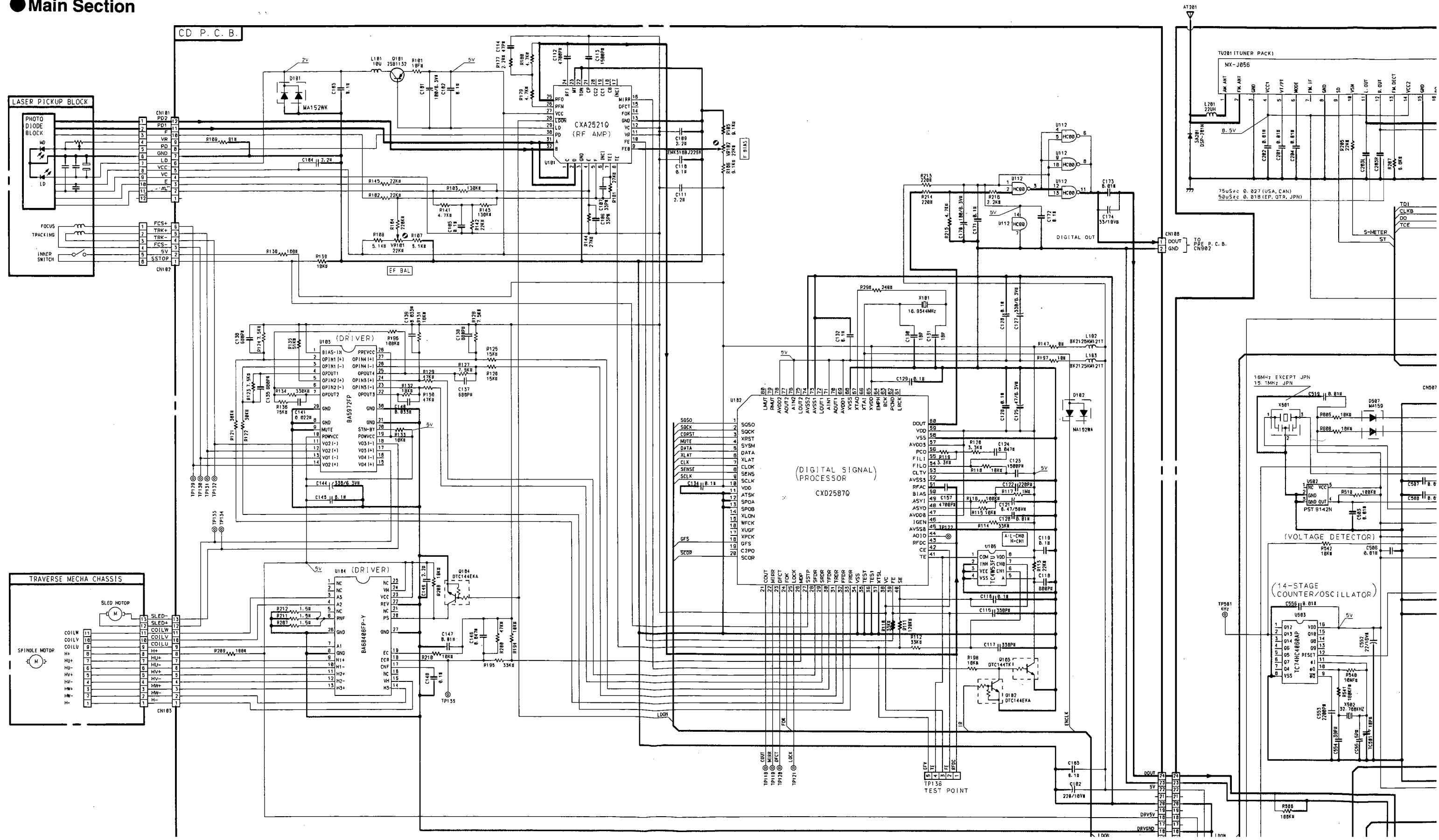

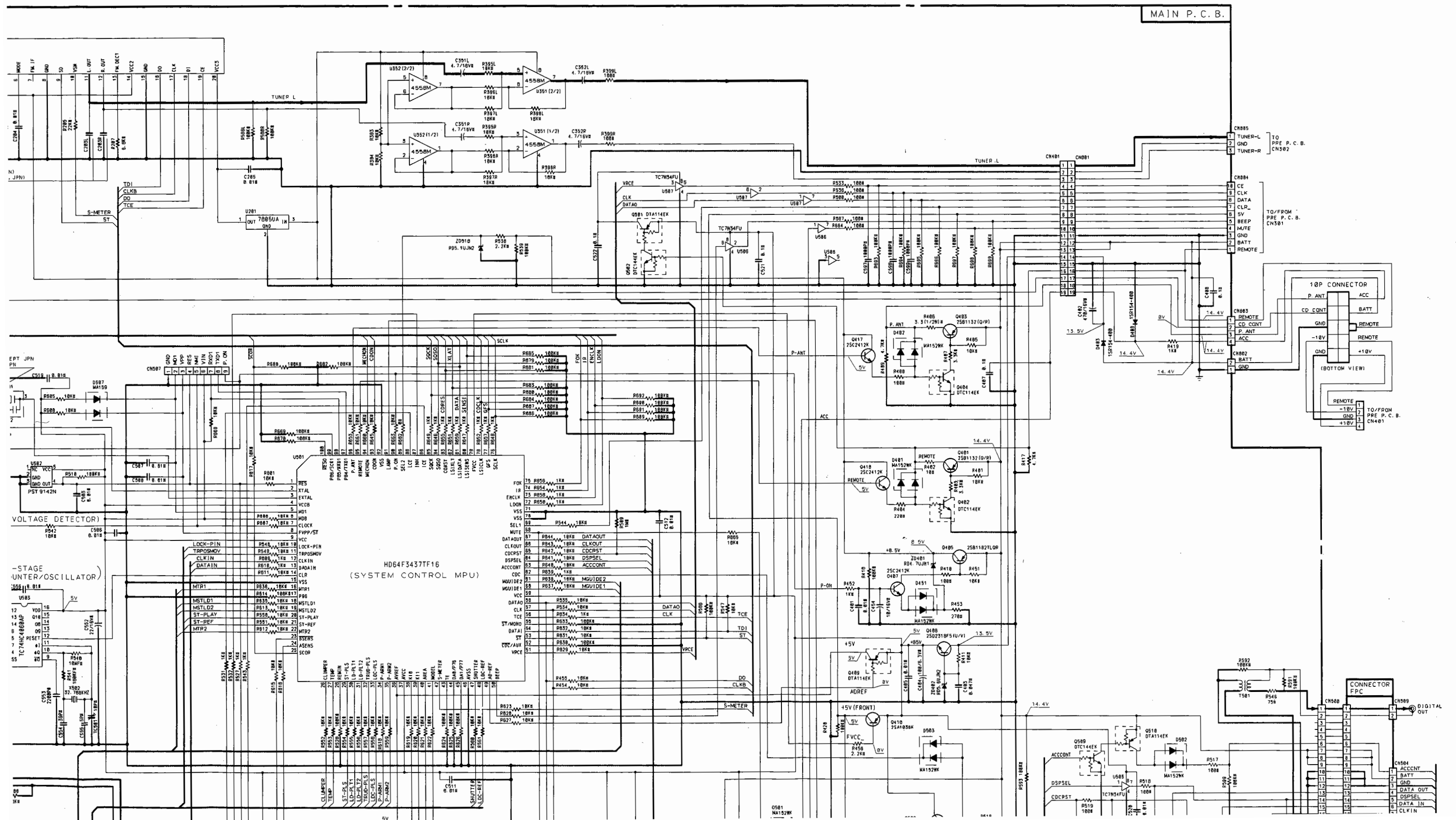

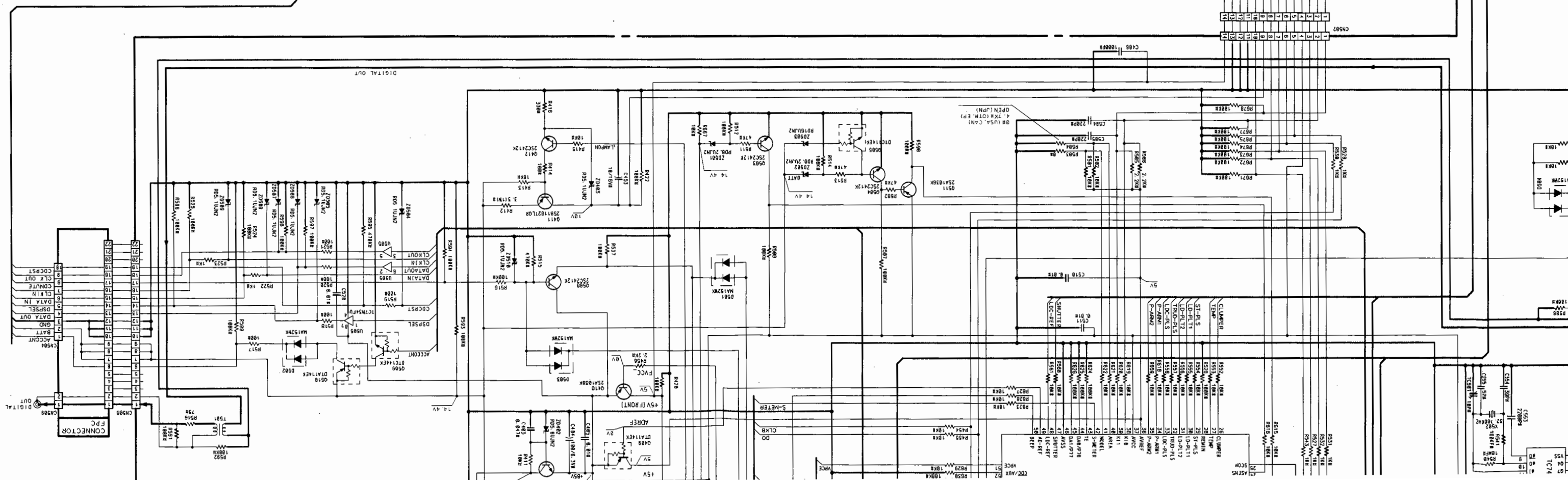

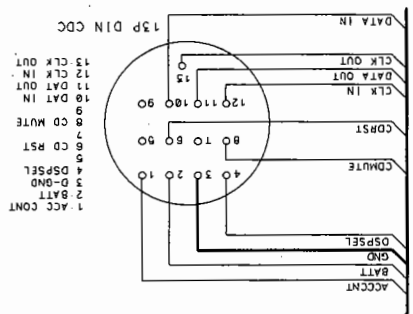
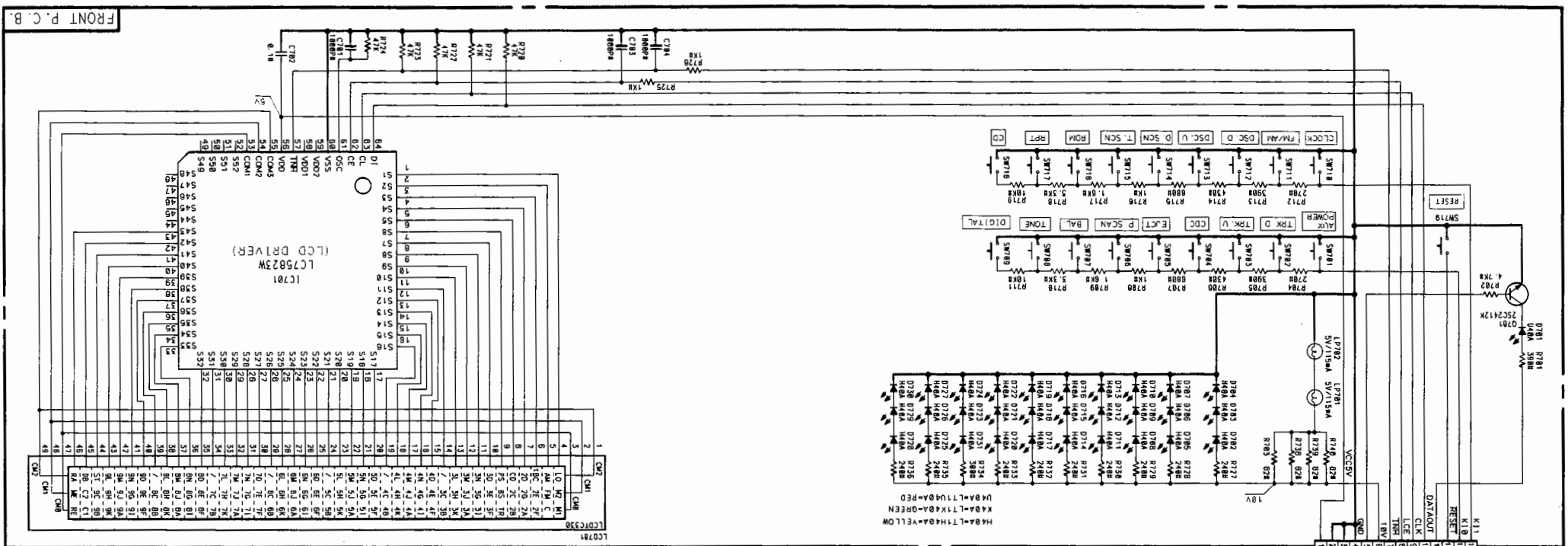
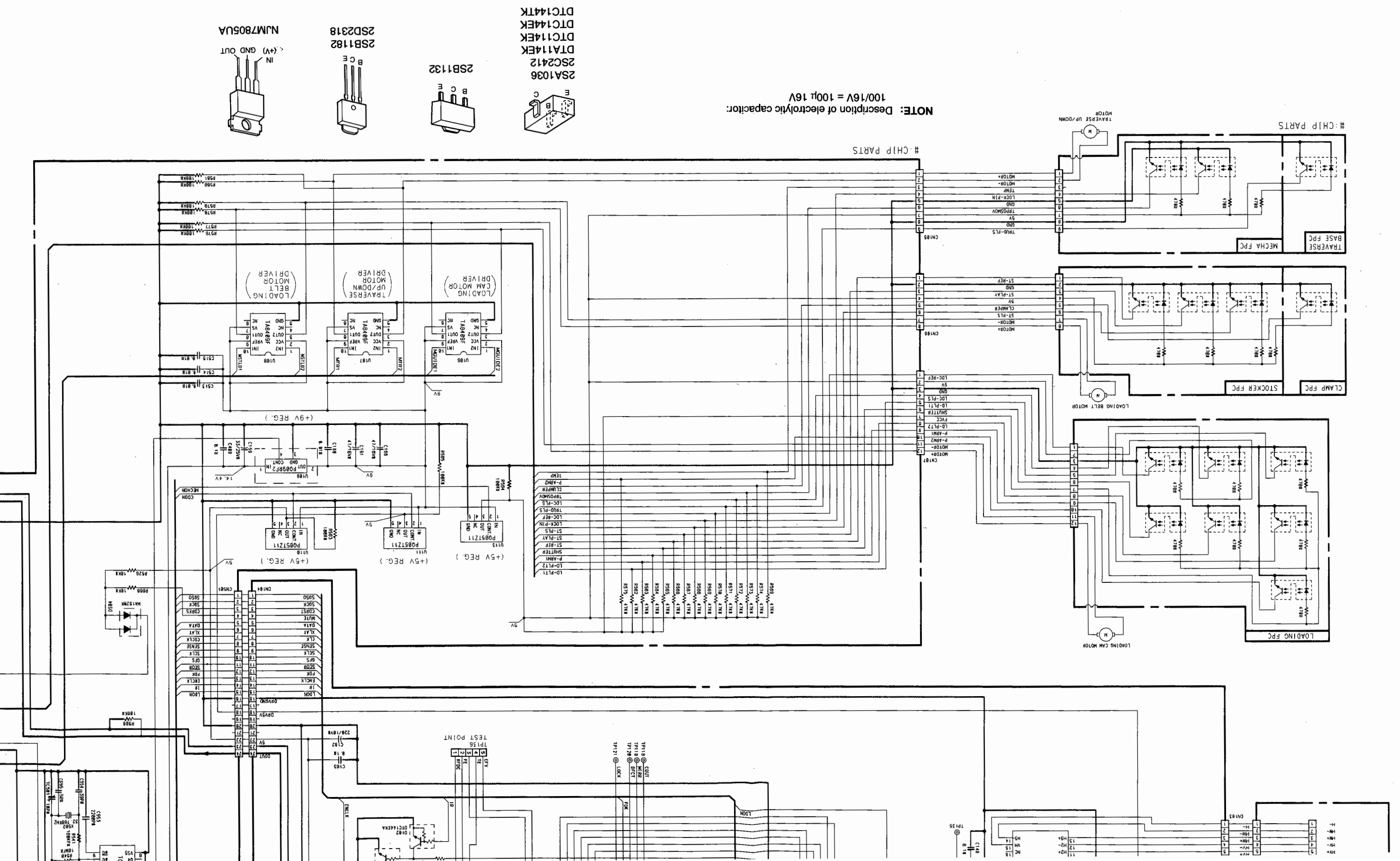

NOTE: Description of electrolytic capacitor:
100/16V = 100µF 16V

- 2SA1036
- 2SC2412
- DTA114EK
- DTC114EK
- DTC144EK
- DTC144TK

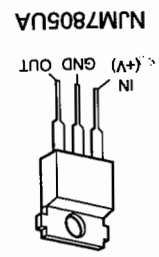
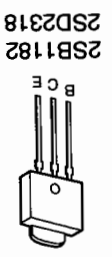

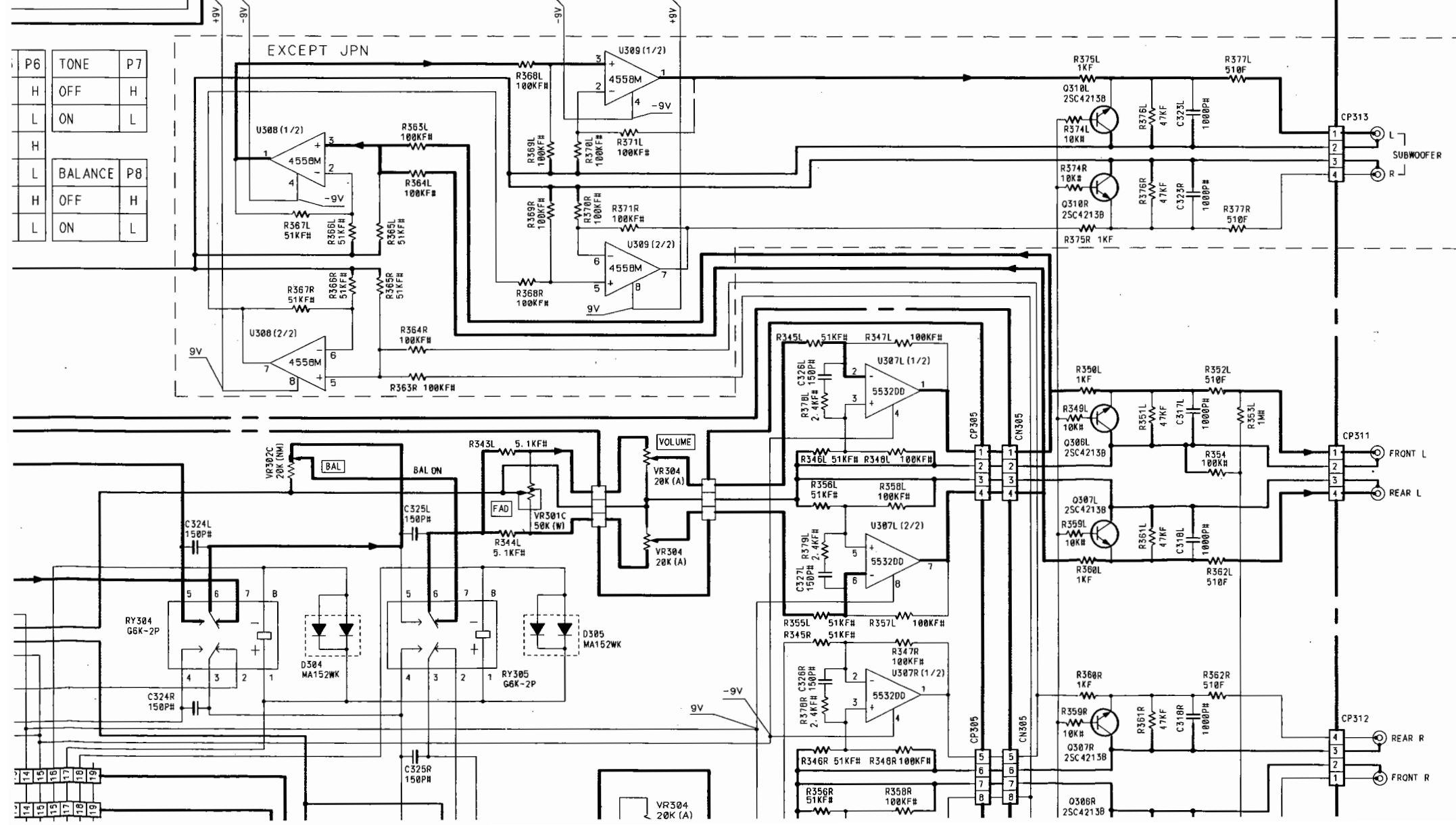
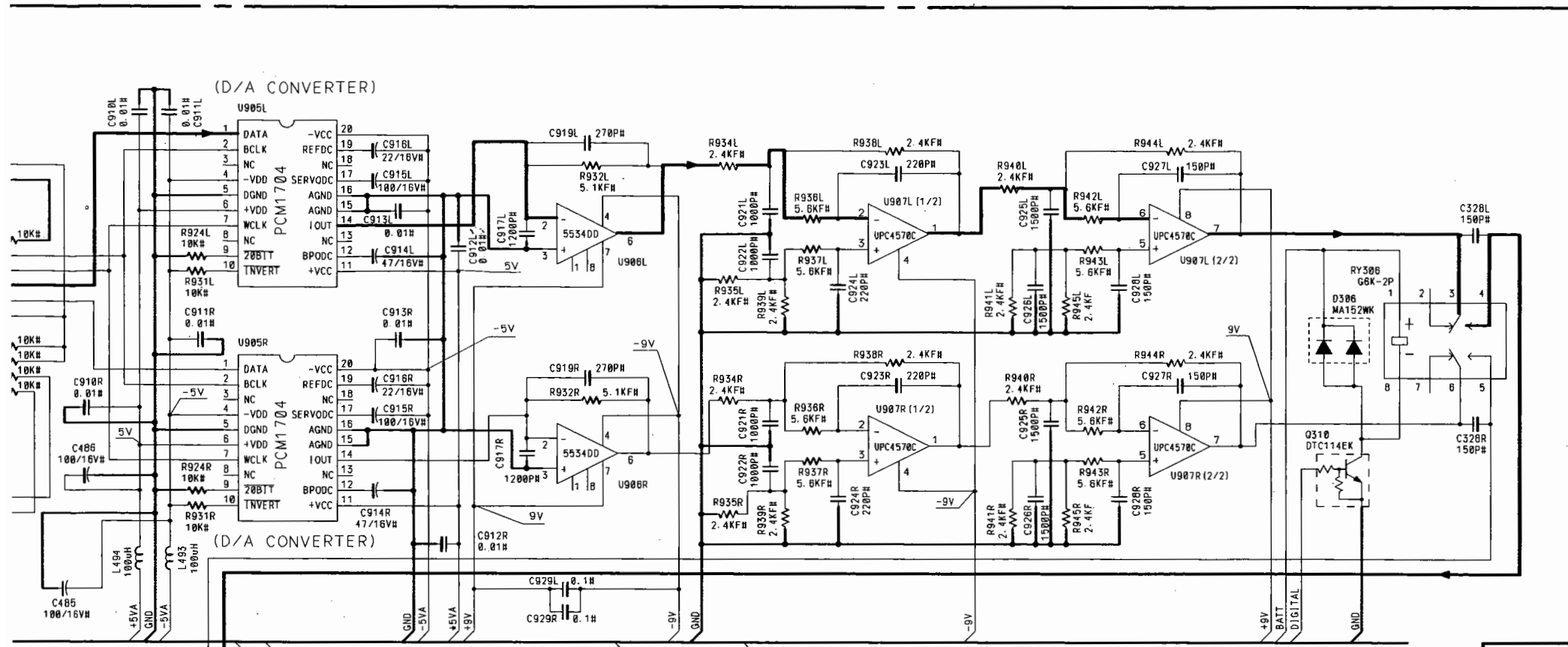

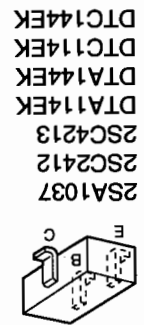
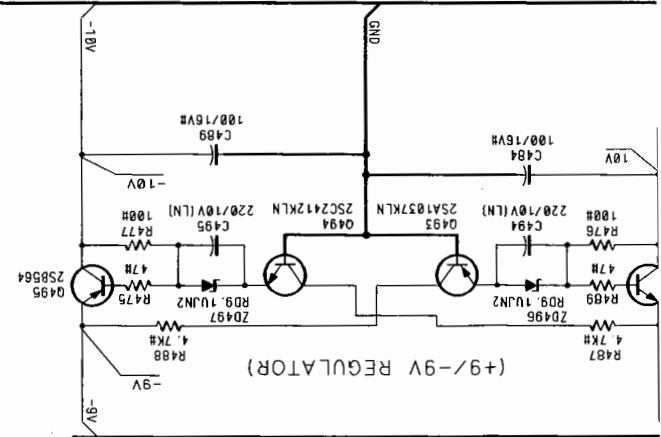

- 2SA1037
- 2SC2412
- 2SC4213
- DTA114EK
- DTA144EK
- DTA144EK
- DTA144EK
- DTC144EK

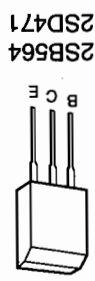

- 2SD471
- 2SB564

NOTE: Description of electrolytic capacitor:
 100/16V = 100µF 16V

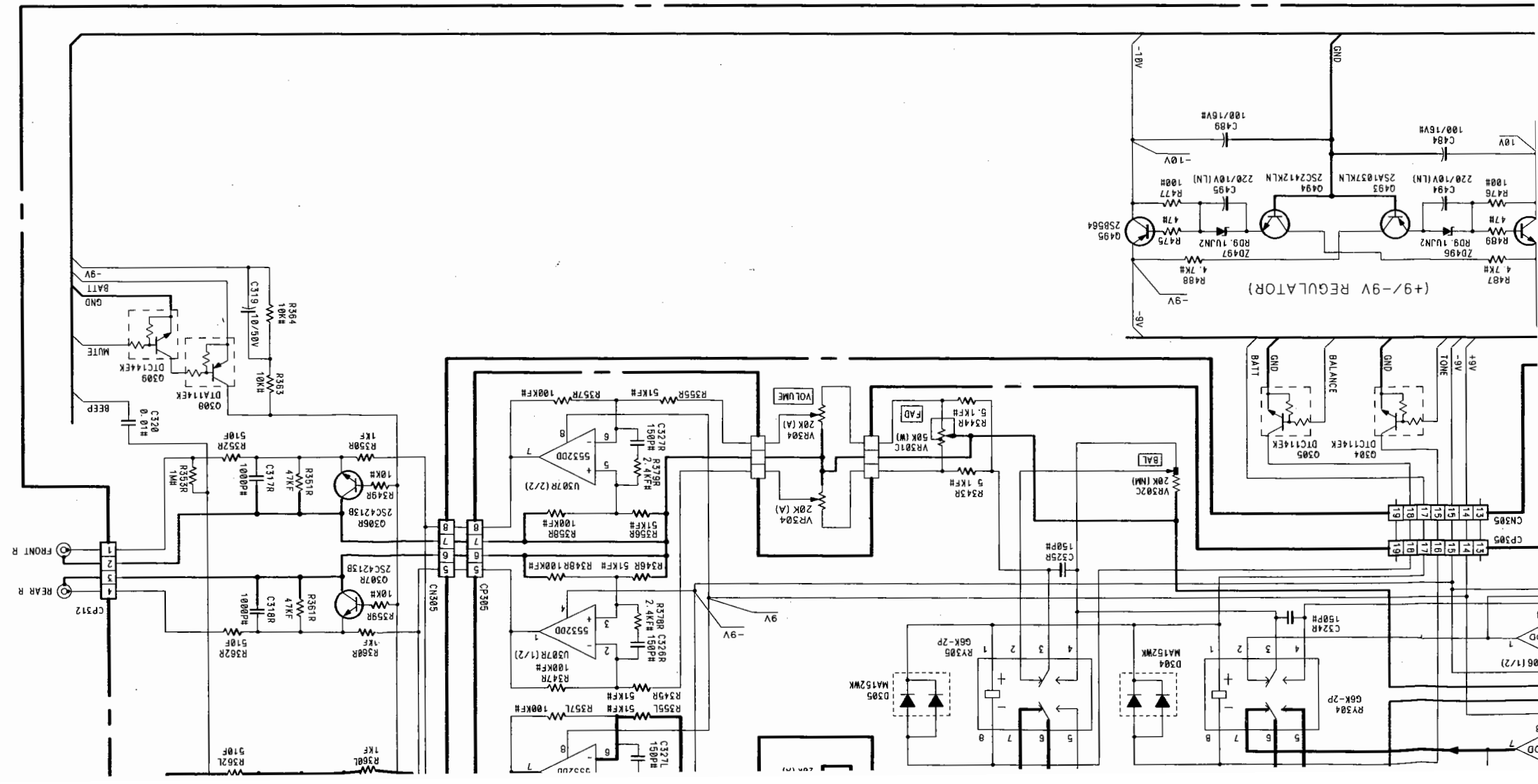

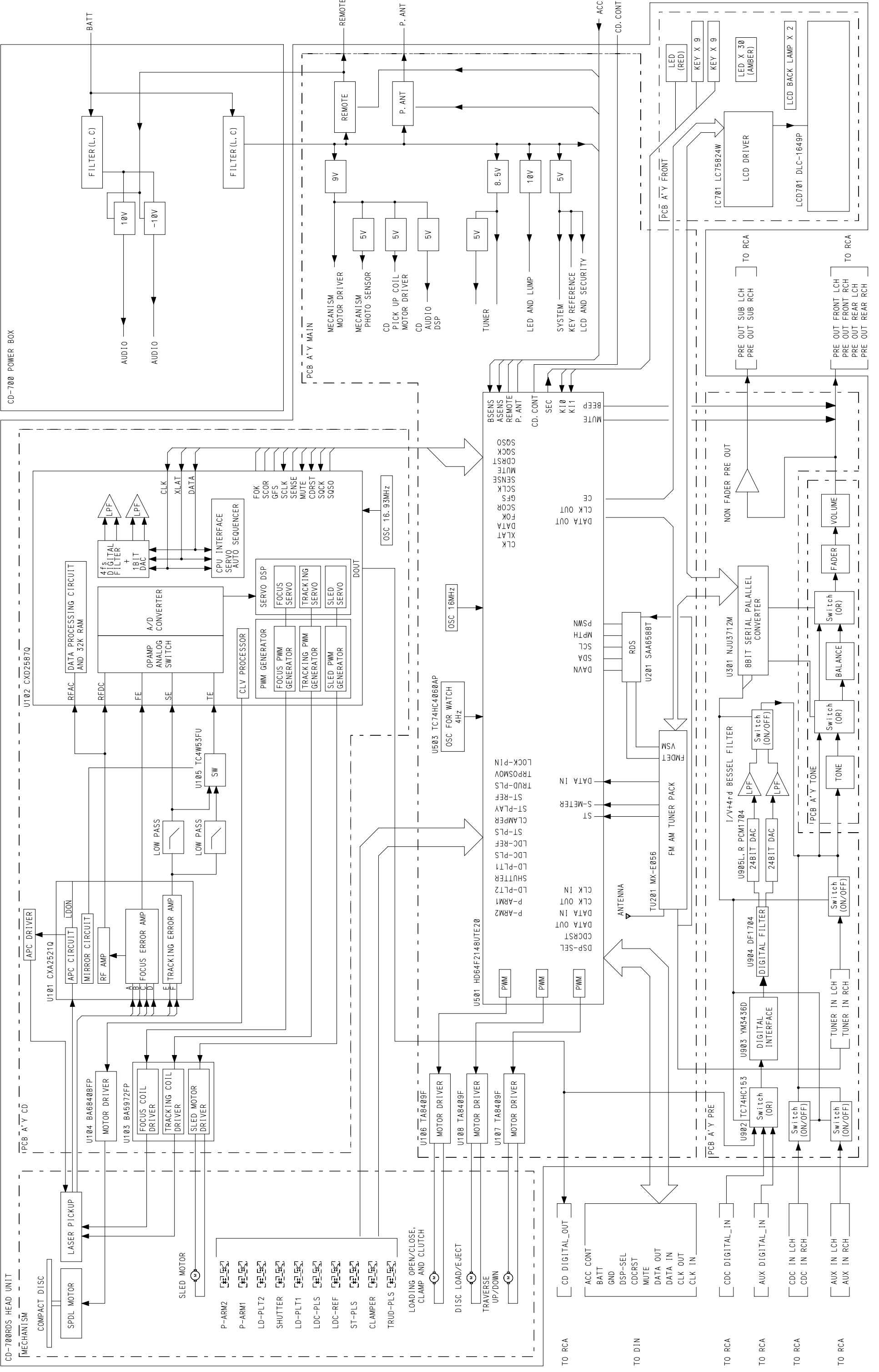

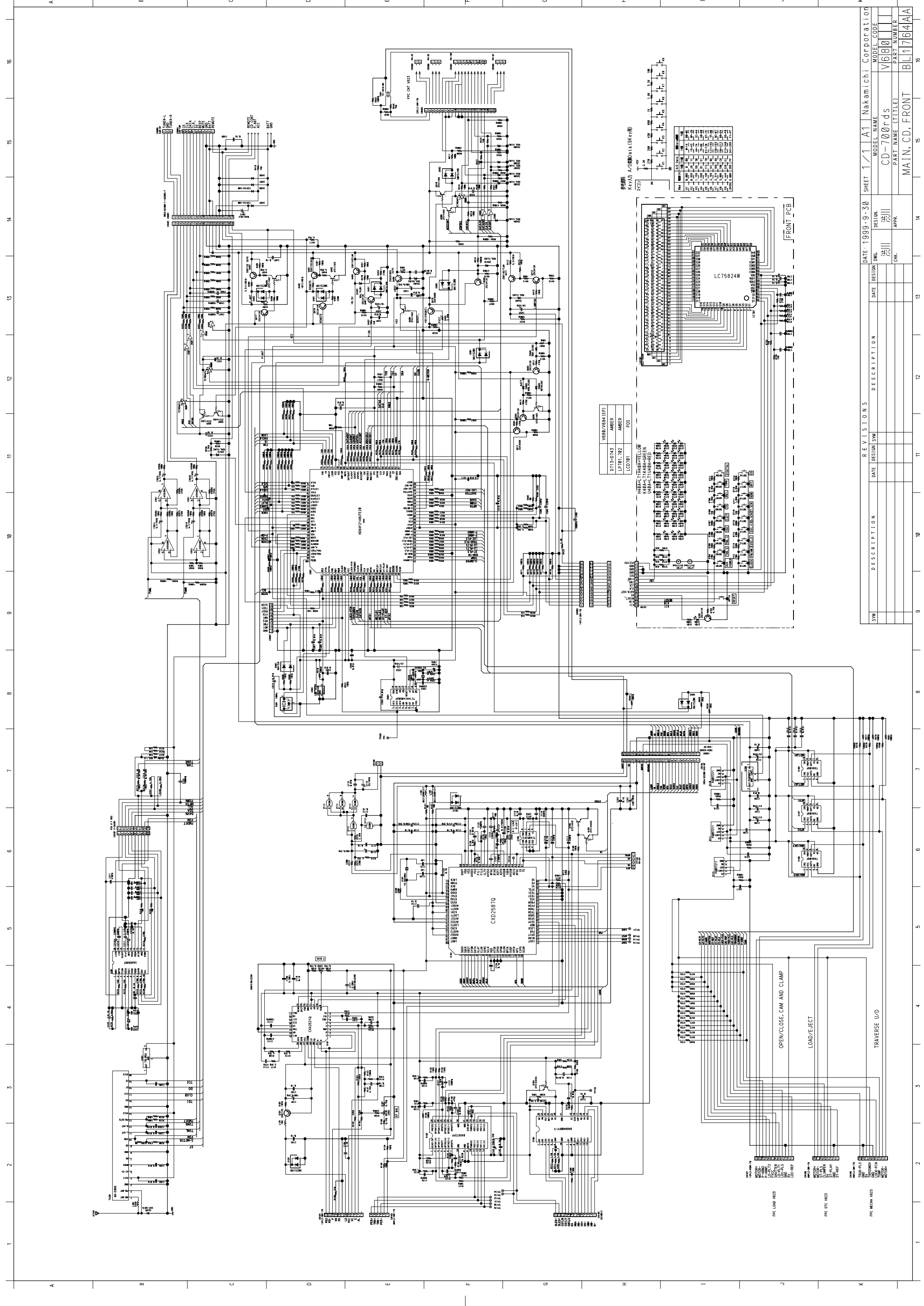

W888/V884 (EP)	
0T15-0T45	AMER
LP781, 782	AMER
LC02B1	POS

キーボード A/Dデータ (8Key用)
772D

KEY	DATA	DATA	DATA	DATA	DATA	DATA	DATA	DATA	DATA
1	0000	0001	0010	0011	0100	0101	0110	0111	1000
2	1001	1010	1011	1100	1101	1110	1111	0000	0001
3	0010	0011	0100	0101	0110	0111	1000	1001	1010
4	1011	1100	1101	1110	1111	0000	0001	0010	0011
5	0011	0100	0101	0110	0111	1000	1001	1010	1011
6	1010	1011	1100	1101	1110	1111	0000	0001	0010
7	0010	0011	0100	0101	0110	0111	1000	1001	1010
8	1011	1100	1101	1110	1111	0000	0001	0010	0011

SYMBOL		DESCRIPTION	DATE	DESIGN	SYM	DESCRIPTION	DATE	DESIGN	DATE	1999-9-30	SHEET 1/1	A1	Nakamichi Corporation
REVISIONS													
MODEL NAME		CD-700rds											
PART NUMBER		V1680											
PART NAME (TITLE)		MAIN, CD, FRONT											
APPR.		浜川											
CHK.		浜川											
MODEL CODE		BL17641A											

FRONT PCB

OPEN/CLOSE, CAM AND CLAMP

LOAD/EJECT

TRAVERSE I/D

FRONT PCB

1 2 3 4 5 6 7 8 9 10 11 12 13 14 15 16