

# NEC

# DVD PLAYER/ VIDEO CASSETTE RECORDER

## OWNER'S MANUAL

MODEL : NDT-43



**Before connecting, operating or adjusting this product, please read this instruction booklet carefully and completely.**

# Safety Precautions



**CAUTION**  
RISK OF ELECTRIC SHOCK  
DO NOT OPEN



**CAUTION: TO REDUCE THE RISK OF ELECTRIC SHOCK DO NOT REMOVE COVER (OR BACK) NO USER-SERVICEABLE PARTS INSIDE REFER SERVICING TO QUALIFIED SERVICE PERSONNEL.**



This lightning flash with arrowhead symbol within an equilateral triangle is intended to alert the user to the presence of uninsulated dangerous voltage within the product's enclosure that may be of sufficient magnitude to constitute a risk of electric shock to persons.



The exclamation mark within an equilateral triangle is intended to alert the user to the presence of important operating and maintenance (servicing) instructions in the literature accompanying the product.

**WARNING: TO REDUCE THE RISK OF FIRE OR ELECTRIC SHOCK, DO NOT EXPOSE THIS PRODUCT TO RAIN OR MOISTURE.**

**CAUTION:** Do not block any ventilation openings. Install in accordance with the manufacturer's instructions.

Slots and openings in the cabinet are provided for ventilation and to ensure reliable operation of the product and to protect it from over heating.

The openings should be never be blocked by placing the product on a bed, sofa, rug or other similar surface. This product should not be placed in a built-in installation such as a bookcase or rack unless proper ventilation is provided or the manufacturer's instruction have been adhered to.

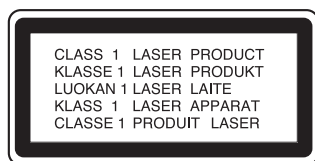

## CAUTION:

This Digital Video Disc Player employs a Laser System. To ensure proper use of this product, please read this owner's manual carefully and retain for future reference, should the unit require maintenance, contact an authorized service location-see service procedure.

Use of controls, adjustments or the performance of procedures other than those specified herein may result in hazardous radiation exposure.

To prevent direct exposure to laser beam, do not try to open the enclosure. Visible laser radiation when open. **DO NOT STARE INTO BEAM.**

**CAUTION: VISIBLE AND INVISIBLE LASER RADIATION WHEN OPEN AND INTERLOCKS DEFEATED.**

**CAUTION:** The apparatus shall not be exposed to water, dripping or splashing and that no objects filled with liquids, such as vases, shall be placed on the apparatus.

**SERIAL NUMBER:** The serial number is found on the back of this unit. This number is unique to this unit and not available to others. You should record requested information here and retain this guide as a permanent record of your purchase.

Model No. \_\_\_\_\_

Serial No. \_\_\_\_\_

## CAUTION concerning the Power Cord

**Most appliances recommend they be placed upon a dedicated circuit;**

That is, a single outlet circuit which powers only that appliance and has no additional outlets or branch circuits. Check the specification page of this owner's manual to be certain.

Do not overload wall outlets. Overloaded wall outlets, loose or damaged wall outlets, extension cords, frayed power cords, or damaged or cracked wire insulation are dangerous. Any of these conditions could result in electric shock or fire. Periodically examine the cord of your appliance, and if its appearance indicates damage or deterioration, unplug it, discontinue use of the appliance, and have the cord replaced with an exact replacement part by an authorized services.

Protect the power cord from physical or mechanical abuse, such as being twisted, kinked, pinched, closed in a door, or walked upon. Pay particular attention to plugs, wall outlets, and the point where the cord exits the appliance.

To disconnect power from the mains, pull out the mains cord plug. When installing the product, ensure that the plug is easily accessible.

- The appliance is not intended for use by young children or infirm persons without supervision.
- Young Children should be supervised to ensure that they do not play with appliance.
- If the appliance is supplied from a cord extension set or an electrical portable outlet device, the cord extension set on electrical portable outlet device must be positioned so that it is not subject to splashing or ingress of moisture.

# Table of Contents

## Introduction

Safety Precautions	2
Table of Contents	3
Before Use	4-5
About the  Symbol Display	4
Symbol used in this Manual	4
Notes on Discs	4
Handling Discs	4
Storing Discs	4
Cleaning Discs	4
Selecting the Viewing Source	4
Types of Playable Discs	5
Regional Code	5
Front Panel	6
Remote Control	7
Rear Panel	8

## Preparation

Connections	9-10
Connecting to a TV	9
Connecting to Optional Equipment	10
Before Operation-VCR part	11-15
Tuning in a video channel on your TV	11
Using your VCR for the very first time	11
Setting the clock Manually	12
To set the colour system	12
How to use the main menu	13
Tuning in TV Stations Automatically	13
Tuning in TV Stations Manually	14
Changing the order of TV Stations	15
Deleting TV Stations	15
Before Operation-DVD part	16-19
Displaying Disc Information on-screen	16
Initial Settings	16
General Operation	16
LANGUAGE	17
• Menu Language	17
• Disc Audio / Subtitle / Menu	17
DISPLAY	17
• TV Aspect	17
• Display Mode	17
• Progressive Scan	17
• TV Output Select	17
AUDIO	18
• Dolby Digital / DTS / MPEG	18
• Sample Freq. (Frequency)	18
• DRC (Dynamic Range Control)	18
• Vocal	18
LOCK (Parental Control)	18
• Rating	18
• Password (Security Code)	18
• Area Code	19
OTHERS	19
• PBC	19
• Auto Play	19
• DivX(R) VOD	19

## Operation

Operation with tape	20-23
Playing a tape	20
• CM (Commercial Message) Skip	20
• OPR (Optimum Picture Response)	20
Quick Set Recording (QSR)	21
Timer recording using On Screen Display	22-23
Additional Operation - VCR part	24-26
Hi-Fi Stereo Sound System	24
On Screen Display (F.OSD)	24
Tape Counter Memory Stop	24
Video Doctor (Self-Diagnosis)	25
1W Mode (Power save mode)	25
Recording from External Components	26
Copying from DVD to VCR	26
General Playback features - DVD Part	27
Playing a DVD or Video CD	28
Additional features	28
• 3D Surround	28
• Time Search	28
• Marker Search	28
• Last Scene Memory	28
• Screen Save	28
Playing an Audio CD or MP3/WMA file	29
Programmed Playback	29
• Repeat Programmed Tracks	29
• Erasing a Track from Program List	29
• Erasing the Complete Program List	29
Viewing a JPEG file	30
Slide Show	30
Still Picture	30
Moving to another File	30
Zoom	30
To rotate picture	30
Playing a DivX Movie file	31
Playing a DVD VR format Disc	32
Additional Operation	33
Maintenance and Service	33
Reference	
Language and Area Code List	34
Language Code List	34
Area Code List	34
Troubleshooting	35
Specification	36

## Before Use

To ensure proper use of this product, please read this owner's manual carefully and retain for future reference.

This manual provides information on the operation and maintenance of your DVD player. Should the unit require service, contact an authorized service location.

### About the Symbol Display

"" may appear on your TV display during operation and indicates that the function explained in this owner's manual is not available on that specific DVD video disc.

### Symbol Used in this Manual



**Note:**

Indicates special notes and operating features.

**Tip:**

Indicates tips and hints for making the task easier.

A section whose title has one of the following symbols is applicable only to the disc represented by the symbol.

-  All discs listed below
-  DVD and finalized DVD±R/RW
-  Video CDs
-  Audio CDs
-  MP3 files
-  WMA files
-  DivX files

## Notes on Discs

### Handling Discs

Do not touch the playback side of the disc. Hold the disc by the edges so that fingerprints do not get on the surface. Never stick paper or tape on the disc.



### Storing Discs

After playing, store the disc in its case. Do not expose the disc to direct sunlight or sources of heat and never leave it in a parked car exposed to direct sunlight.

### Cleaning Discs

Fingerprints and dust on the disc can cause poor picture quality and sound distortion. Before playing, clean the disc with a clean cloth. Wipe the disc from the center out.

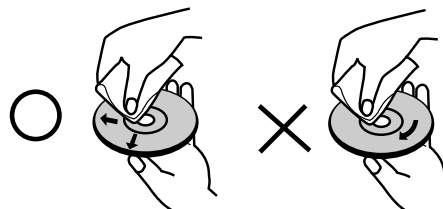

Do not use strong solvents such as alcohol, benzene, thinner, commercially available cleaners, or anti-static spray intended for older vinyl records.

### Selecting the Viewing Source

You must select one of your output sources (DVD or VCR) to view on the TV screen.



- **If you want to view DVD deck output source:**  
Press DVD until DVD indicator in the display window lights and output source of DVD deck is viewed on the TV screen.
- **If you want to view VCR deck output source:**  
Press VCR until VCR indicator in the display window lights and output source of VCR deck is viewed on the TV screen.

### Notes:

- If you insert a disc while this unit is in the VCR mode, this unit will switch to DVD mode automatically.
- If you insert a cassette tape without prevention tab while this unit is in the DVD mode, this unit will switch to VCR mode automatically.

## Before Use (Continued)

### Types of Playable Discs

	DVD (8 cm / 12 cm disc)
	Video CD (VCD) (8 cm / 12 cm disc)
	Audio CD (8 cm / 12 cm disc)

In addition, this unit plays DVD±R/RW, CD-R/RW and SVCD that contains audio titles, DivX, MP3, WMA, and/or JPEG files.

**RW COMPATIBLE** This indicates a product feature that is capable of playing DVD-RW discs recorded with Video Recording format.

#### Notes:

- Depending on the conditions of the recording equipment or the CD-R/RW (or DVD±R/RW) disc itself, some CD-R/RW (or DVD±R/RW) discs cannot be played on the unit.
- Do not use irregularly shaped CDs (e.g., heart-shaped or octagonal) since they may result in malfunctions.
- This unit requires discs and recordings to meet certain technical standards in order to achieve optimal playback quality. Pre-recorded DVDs are automatically set to these standards. There are many different types of recordable disc formats (including CD-R containing MP3 or WMA files) and these require certain pre-existing conditions (see above) to ensure compatible playback.

**Customers should note that permission is required in order to download MP3 / WMA files and music from the Internet. Our company has no right to grant such permission. Permission should always be sought from the copyright owner.**

#### Regional Code

This unit has a regional code printed on the rear of the unit. This unit can play only DVD discs labelled same as the rear of the unit or "ALL".

#### Notes on Regional Codes

- Most DVD discs have a globe with one or more numbers in it clearly visible on the cover. This number must match your unit's regional code or the disc cannot play.
- If you try to play a DVD with a different regional code from your player, the message "Check Regional Code" appears on the TV screen.

#### Notes on Copyrights:

It is forbidden by law to copy, broadcast, show, broadcast via cable, play in public, or rent copyrighted material without permission. This product features the copy protection function developed by Macrovision. Copy protection signals are recorded on some discs. When recording and playing the pictures of these discs picture noise will appear. This product incorporates copyright protection technology that is protected by method claims of certain U.S. patents and other intellectual property rights owned by Macrovision Corporation and other rights owners. Use of this copyright protection technology must be authorized by Macrovision Corporation, and is intended for home and other limited viewing uses only unless otherwise authorized by Macrovision Corporation. Reverse engineering or disassembly is prohibited.

CONSUMERS SHOULD NOTE THAT NOT ALL HIGH DEFINITION TELEVISION SETS ARE FULLY COMPATIBLE WITH THIS PRODUCT AND MAY CAUSE ARTIFACTS TO BE DISPLAYED IN THE PICTURE. IN CASE OF 625 PROGRESSIVE SCAN PICTURE PROBLEMS, IT IS RECOMMENDED THAT THE USER SWITCH THE CONNECTION TO THE 'STANDARD DEFINITION' OUTPUT. IF THERE ARE QUESTIONS REGARDING OUR TV SET COMPATIBILITY WITH THIS MODEL 625p DVD PLAYER, PLEASE CONTACT OUR CUSTOMER SERVICE CENTER.

# Front Panel

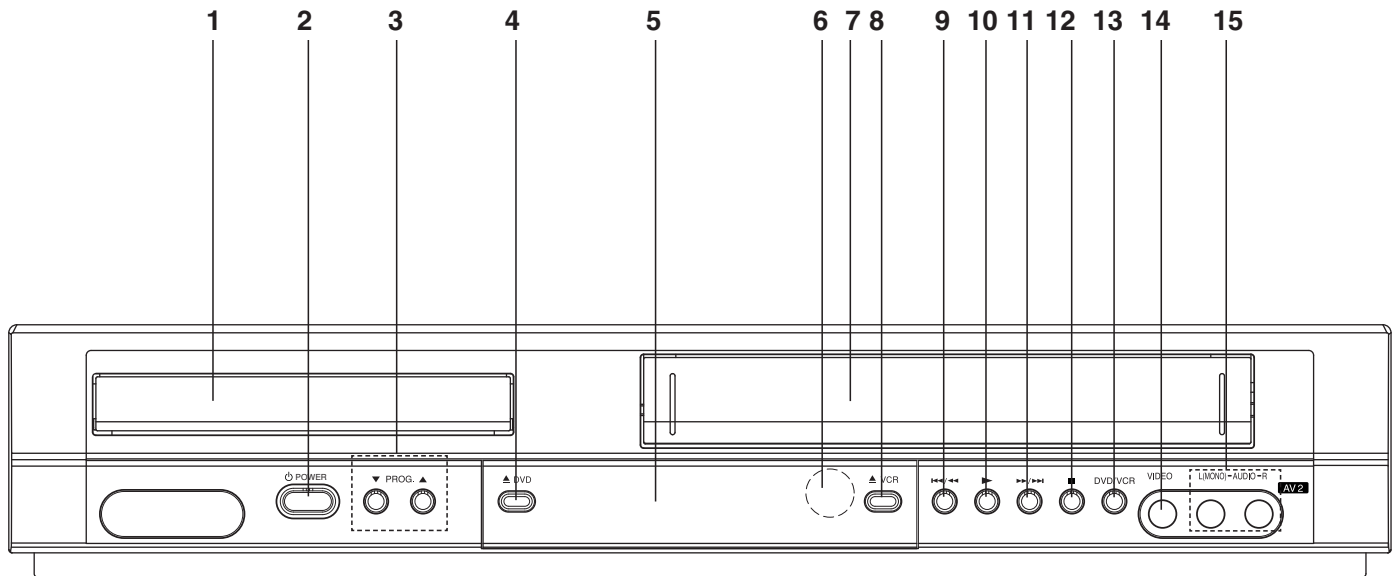

**1. Disc Tray**

Insert a disc here.

**2. POWER**

Switches the unit to ON or OFF.

**3. PROG. (▼/▲) Channel Programme Selectors.**

**4. DVD**

Opens or closes the disc tray.

**5. Display window**

Shows the current status of the unit.

**DVD:** DVD deck is selected.

: A disc is loaded in the DVD deck.

**[P]:** Indicates the Progressive Scan is set to On mode.

: Indicates repeat mode.

: Child Lock is engaged.

: DVD+VCR is in timer recording or a timer recording is programmed.

: A Cassette is in the VCR deck.

**VCR:** VCR deck is selected.

**REC:** VCR recording is engaged.

DVD to VHS copy is in progress.

**TV:** Indicates TV mode. (See Notes on page 21.)

: Indicates total playing time/elapsed time/current time.

**6. Remote Sensor**

Point the remote control here.

**7. Tape Compartment**

**8. VCR**

Tape Eject

**9. Rewind**

Go to beginning of current chapter/track or to PREVIOUS chapter/track.

Press and hold for two seconds for a fast reverse search. Rewinds the tape.

**10. Play**

Starts playback.

**11. Fast Forward**

Go to NEXT chapter/track.

Press and hold for two seconds for a fast forward search. Winds the tape forwards.

**12. Stop**

Stops playback.

**13. DVD/VCR**

DVD/VCR Selector

**14. Video IN Jack**

**15. Audio IN (L/R) Jacks**



# Remote Control

## OPERATE

Switch this unit ON or OFF.

## OPEN/CLOSE

## EJECT

Open or close the the disc tray.

Tape Eject.

## TV/VCR

Switch between your TV's tuner and the VCR's internal tuner.

## DVD/VCR select button

Selects operational mode of remote control.

## AV

Select input source for recording into tape.

## PAUSE/STEP (II)

Pause playback temporarily / press repeatedly for frame-by-frame playback.

## SKIP (I◀◀ / ▶▶I)

Go to next chapter or track. Returns to beginning of current chapter or track or go to previous chapter or track.

## STOP (■)

Stops playback.

## BACKWARD / FORWARD

## (◀◀ / ▶▶)

DVD: Search backward or forward.  
VCR: Rewinds the tape during the STOP mode, for fast reverse picture search and Advances the tape during the STOP mode, fast forward picture search.

## PLAY (▶)

Starts playback.

## AUDIO

Select an audio language (DVD) or an audio channel (CD).

## SUBTITLE

Select a subtitle language.

## ANGLE

Select DVD camera angle if available

## ZOOM

Enlarge video image.

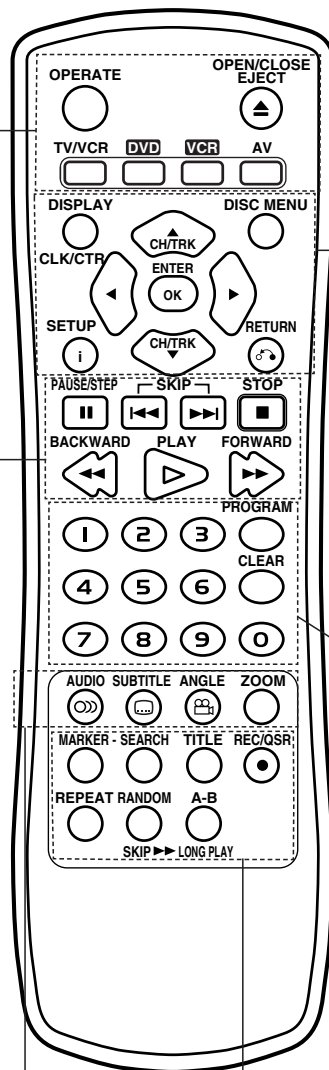

## DISPLAY

## CLK/CTR

Access the On-Screen Display. Shows you the current time or counter.

## DISC MENU

Access menu of a DVD disc.

## ENTER/OK

Acknowledge menu selection.

## ◀ ▶ ▲ ▼ (left/right/up/down)

Select an item in the menu

## CH/TRK(▲/▼)

Select channel programme of VCR.

To adjust tracking.

To control vertical tremble during picture still.

## SETUP/ i

Access or remove setup menu.

## RETURN

Remove the setup menu.

Displays the menu of a video CD with PBC.

## 0-9 numerical buttons

Select numbered items in a menu.

## PROGRAM

Access or remove program menu.

## CLEAR

Clear a track number on the program menu or a mark on the MARKER SEARCH menu. Reset tape counter to zero.

## MARKER

Mark any point during playback.

## SEARCH

Display MARKER SEARCH menu.

## TITLE

Display the title menu of the disc if available.

## REC/QSR

Record your input sources into tape.

## REPEAT

Repeat chapter, track, title, all.

## RANDOM/SKIP ▶▶

Play tracks in random order.

## CM SKIP

## A-B/LONG PLAY

Repeat sequence.

Select the recording speed of the tape.

## Remote Control Operation

Point the remote control at the remote sensor and press the buttons.

## Remote control battery installation

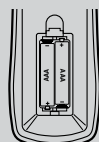

Detach the battery cover on the rear of the remote control, and insert two batteries (size AAA) with ⊕ and ⊖ aligned correctly.)



Do not mix old and new batteries and never mix different types of batteries such as standard, alkaline, etc.

# Rear Panel

## AERIAL

Connect the aerial using this jack.

## AUDIO IN (Left/Right) (VCR IN AV1)

Receive the audio signals from an external source to VCR.

## AUDIO OUT (Left/Right) (DVD/VCR OUT)

Connect to an amplifier, receiver or stereo system.

## COMPONENT/PROGRESSIVE SCAN VIDEO OUT (Y Pb Pr) (DVD EXCLUSIVE OUT)

Connect to a TV with Y Pb Pr inputs.

## AUDIO OUT (Left/Right) (DVD EXCLUSIVE OUT)

Connect to an amplifier, receiver or stereo system.

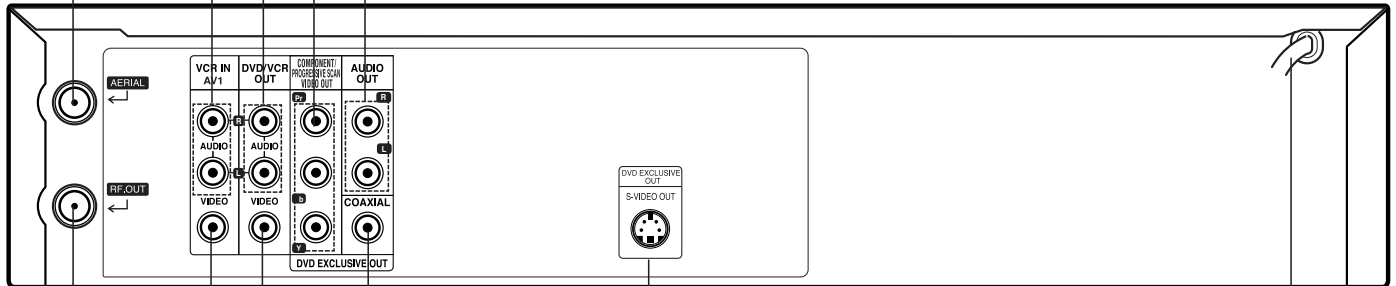

## AC Power Cord

Connect to a power source.

## S-VIDEO OUT (DVD EXCLUSIVE OUT)

Connect to a TV with S-Video input.

## COAXIAL (Digital audio out jack) (DVD EXCLUSIVE OUT)

Connect to digital (coaxial) audio equipment.

## VIDEO OUT (DVD/VCR OUT)

Connect to a TV with video inputs.

## VIDEO IN (VCR IN AV1)

Receive the video signals from an external source to VCR.

## RF.OUT

Connect to your TV using this jack.



Do not touch the inner pins of the jacks on the rear panel.  
Electrostatic discharge may cause permanent damage to the unit.



# Connections

## Caution:

- Make sure this unit is connected directly to the TV. Set the TV to the correct video input channel.
- Do not connect this unit's AUDIO OUT jack to the phono in jack (record deck) of your audio system.

## Connecting to a TV

- Make one of the following connections, depending on the capabilities of your existing equipment.
- When using the COMPONENT/PROGRESSIVE SCAN VIDEO OUT jacks, set TV's input to COMPONENT VIDEO. When using the S-VIDEO OUT jack, set the TV's input to S-VIDEO.

### Basic connection (AV)

1. Connect the VIDEO jack on this unit's DVD/VCR OUT to the video in jack on the TV using the video cable (V).
2. Connect the Left and Right AUDIO jacks of this unit's DVD/VCR OUT to the audio left/right in jacks on the TV using the audio cables (A1).

### Basic connection (RF)

1. Connect the RF antenna cable from your indoor/outdoor antenna to AERIAL jack on the rear panel of this unit.
2. Connect the supplied RF antenna cable from the RF.OUT jack on the rear panel of this unit to your television's Antenna Input (R).

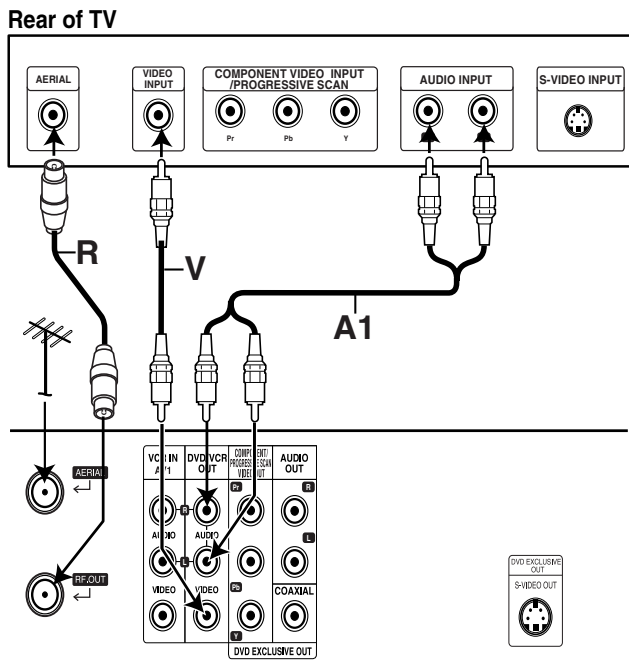

Rear of this unit (Basic connection)

## DVD exclusive out connection

### Component Video connection

1. Connect the COMPONENT/PROGRESSIVE SCAN VIDEO OUT jacks on the DVD Player to the corresponding in jacks on the TV using the Y Pb Pr cable (C).

2. Connect the Left and Right AUDIO OUT jacks of the DVD Player to the audio left/right in jacks on the TV using the audio cables (A2).

### S-Video connection

1. Connect the S-VIDEO OUT jack on this unit to the S-Video input jack on the TV using the S-Video cable (S).
2. Connect the Left and Right AUDIO OUT jacks of the DVD Player to the audio left/right in jacks on the TV using the audio cables.

### Progressive Scan connection

- If your television is a high-definition or "digital ready" television, you may take advantage of the DVD Player's progressive scan output for the highest video resolution possible.
  - If your TV does not accept the Progressive Scan format, the picture will appear scrambled if you try Progressive Scan on the DVD Player.
1. Connect the COMPONENT/ PROGRESSIVE SCAN VIDEO OUT jacks on the DVD Player to the corresponding in jacks on the TV using the Y Pb Pr cable.
  2. Connect the Left and Right AUDIO OUT jacks of the DVD Player to the audio left/right in jacks on the TV using the audio cables.

### Notes:

- Set the Progressive to "On" on the setup menu for progressive signal, see page 17.
- Progressive scan does not work with the analog video connections (yellow VIDEO OUT jack) or S-VIDEO connection.

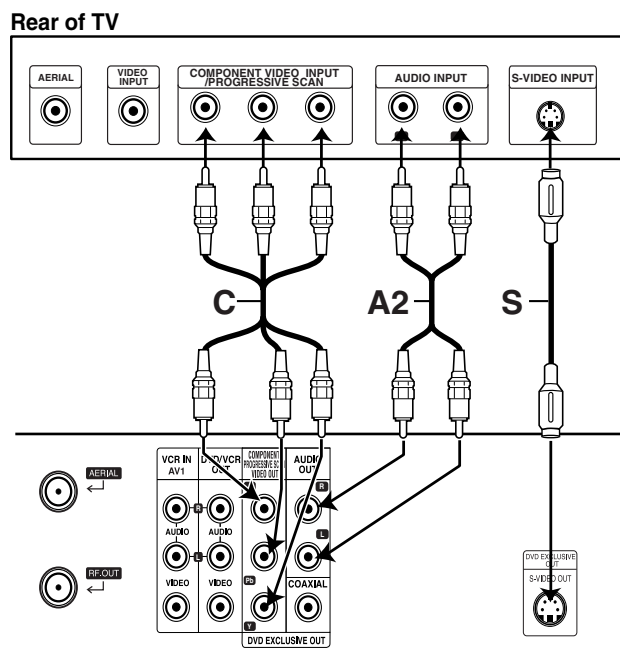

Rear of this unit (DVD exclusive out connection)

### Note:

If the TV has an S-video input, connect the DVD player with the S-video cable. When using an S-video cable, do not connect the yellow video cable.

## Connections (Continued)

### Connecting to Optional Equipment

#### Connecting to an amplifier equipped with two channel analog stereo or Dolby Pro Logic II/Pro Logic

Connect the Left and Right **DVD/VCR AUDIO OUT** or **AUDIO OUT (DVD EXCLUSIVE OUT)** jacks on this unit to the audio left and right in jacks on your amplifier, receiver or stereo system, using the audio cables.

#### Connecting to an amplifier equipped with two channel digital stereo (PCM) or to an Audio/ Video receiver equipped with a multi-channel decoder (Dolby Digital™, MPEG 2 or DTS)

1. Connect one of this unit's **DIGITAL AUDIO OUT** jack (COAXIAL) to the corresponding in jack on your amplifier. Use an optional digital (coaxial) audio cable.
2. You will need to activate this unit's digital output. (See "AUDIO" on page 18).

#### Digital Multi-channel sound

A digital multi-channel connection provides the best sound quality. For this you need a multi-channel Audio/Video receiver that supports one or more of the audio formats supported by your unit (MPEG 2, Dolby Digital and DTS). Check the receiver manual and the logos on the front of the receiver.

#### Warning:

Due to the DTS Licensing agreement, the digital output will be in DTS digital out when DTS audio stream is selected.

#### Notes:

- If the audio format of the digital output does not match the capabilities of your receiver, the receiver will produce a strong, distorted sound or no sound at all.
- To see the audio format of the current DVD in the On-Screen Display, press **AUDIO**.

Manufactured under license from Dolby Laboratories. "Dolby", "Pro Logic" and the double-D symbol are trademarks of Dolby Laboratories.

DTS and DTS Digital Out are trademarks of Digital Theater Systems, Inc.

#### Rear of this unit

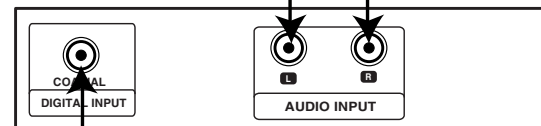
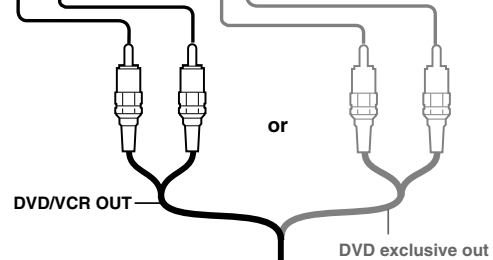
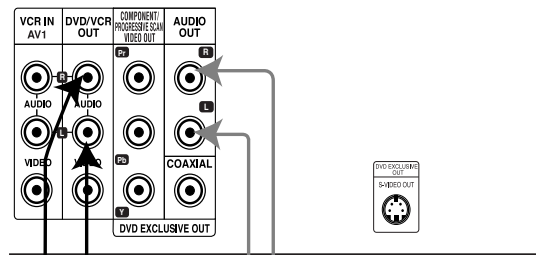

#### Amplifier (Receiver)

Digital multi-channel connection (DVD exclusive out connection)

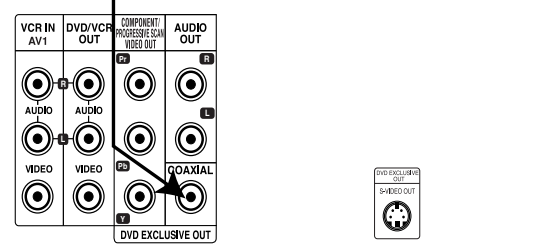

#### Rear of this unit

### Tuning in a video channel on your TV

Video channel (RF output channel) is the channel on which your TV receives picture and sound signals from the DVD+VCR through the RF cable.

If you have used a SCART lead you will not have to tune your TV, simply select the AV channel. The AV channel is already pre-tuned for optimum video playback on your TV.

Perform the following steps only if interference appears in the TV picture after you have moved to a different area or a new station has started broadcasting in your area, or if you change the connection from RF connection to AV connection, or vice versa.

1. Turn on DVD+VCR and TV.
2. Set the vacant position 68 on your TV.
3. Press **OPERATE** on the remote control to enter the stand by mode (the clock indicator will be dimmed).
4. Press and hold **PROG.** (▲ or ▼) on the DVD+VCR for more than 4 seconds.

RF 68 will appear in the display.

The following picture will be displayed on the TV screen.

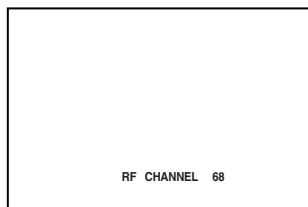

If the picture is snowy, move to step 5. If the picture is clean, press **OPERATE** on the DVD+VCR to finish.

5. Press **PROG.** (▲ or ▼) on the DVD+VCR to set the video channel to a vacant position between 28 and 68 which is not occupied by any local station in your area.

**Note:**

The RF channel will not change until step 6 has been executed.

6. Press **OPERATE** to store the new RF video channel into the DVD+VCR memory.  
Now tune your TV set to the new DVD+VCR RF channel.

**Note**

If the TV picture was clear in step 4, do not retune your TV.

### Using your VCR for the very first time

Following picture will display on the TV screen when you have just connected your video recorder for the very first time.

To make tuning TV stations, please follow stages 3 to 4 as shown "ACMS" (see p.13).

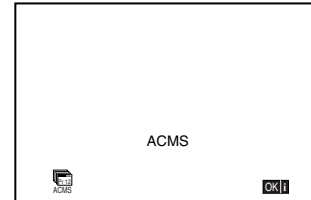

## Before Operation-VCR part

### Setting the clock Manually

The clock in your DVD+VCR controls time and date settings for your DVD+VCR.

1. Press **i**.  
Press **◀** or **▶** to select **SET**.  
Press **ENTER/OK**.

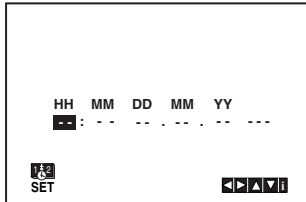

2. Use the **▲** or **▼** on the remote control to alter the **HOURS, MINUTES, DAY, MONTH** and **YEAR**. Please note your DVD+VCR uses a 24 hour clock. e.g. 1pm will be displayed as 13:00. The day of the week will appear automatically when you enter the year.

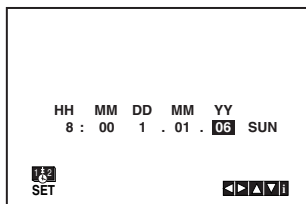

3. If you make a mistake press **◀** or **▶** and enter the correct details.
4. Press **i** to return to a TV picture.

### To set the colour system

1. Press **i**.
2. The main menu will appear on the TV screen.
3. Press **◀** or **▶** to select the **SYS** and press **ENTER/OK**.
4. Press **▲** or **▼** to select according to the **COLOUR** system used.

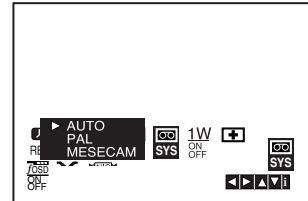

5. Press **▶** to select the **RF AUDIO**. Press **▲** or **▼** to select according to the **RF AUDIO** used.

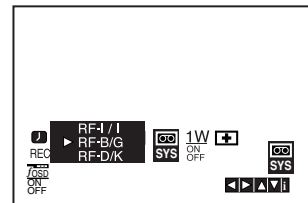

6. Press **i** to remove the menus from the TV screen.

## How to use the main menu

This DVD+VCR can easily be programmed by using the menus displayed on screen.

The menus are controlled by the Remote Control Handset.

1. Switch on your TV set and DVD+VCR by pressing the **POWER** button.
2. Press **i** button.  
The main menu will appear on the TV screen.

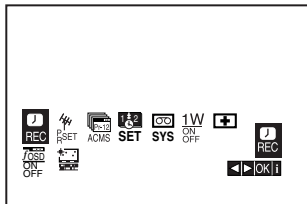

- **REC** - Timer recording setting (see p. 22).
- **PR SET** - Manual tuning setting (see p. 14).
- **ACMS** - ACMS (Automatic Channel Memory System) (see p. 13).
- **SET** - Date & clock setting (see p. 12).
- **SYS** - To set the Colour TV System (see p. 12).
- **1 W ON/OFF** - Power Save Mode (see p. 25).
- **Dr.** - To check a problem with your VCR (see p. 25).
- **F.OSD ON/OFF** - To display the operational mode of your VCR (see p. 24).
- **OPR** - To improve the playback picture (see p. 20).  
Appear when playback only.

### Tip

You can change the menu language on the DVD setup menu. (See the Menu Language on page 17.)

3. Press **◀** and **▶** to select the desired menu.  
Press **ENTER/OK** and use **▲** or **▼** to select.
4. Press **i** to return to a TV picture.

## Tuning in TV Stations Automatically

If the TV broadcast signal is weak your DVD+VCR may not detect the necessary information and will not be able to store them correctly. To overcome this problem please turn to the **MANUAL TUNING** section on page 14.

1. Press **POWER** to turn on your DVD+VCR.
2. Press **i** button.  
The main menu will appear on the TV screen.  
Press **◀** or **▶** to select the **ACMS**.  
Press **ENTER/OK**.

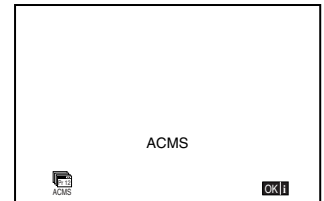
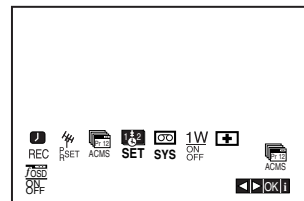

3. Press **OK** again to start the automatic tuning process.

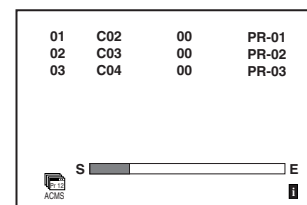

4. The **TV STATION TABLE** will appear when tuning is completed.  
Press **i** to save your settings.

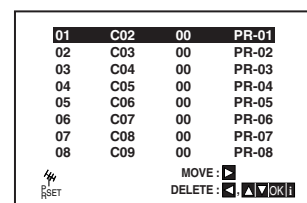

## Before Operation-VCR part

### Tuning in TV Stations Manually

In certain areas of the country broadcast signals may be too weak for your DVD+VCR's automatic tuning process to find or assign TV stations correctly. You must tune in these weaker broadcast stations manually in order for your DVD+VCR to store them.

- Press **i**.  
The main menu will appear on the TV screen.  
Press **◀** or **▶** to select the **PR SET**.  
Press **ENTER/OK**.

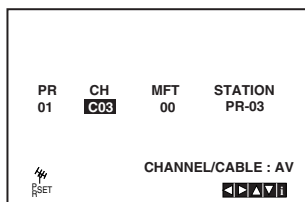
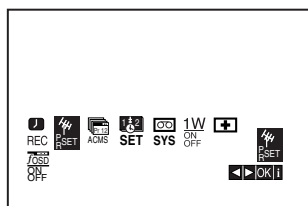

- Press **i**.  
The station table will appear.
- Press **▲** or **▼** to select the programme number that you want to tune (for example, PR 04).

PR	CH	MFT	STATION
01	C01	00	PR-01
02	C02	00	PR-02
03	C03	00	PR-03
04	--	--	----
05	--	--	----
06	--	--	----
07	--	--	----
08	--	--	----

MOVE: **▶**  
DELETE: **◀**, **▲**, **▼**, **OK**, **⏏**

- Press **ENTER/OK**.  
Press **AV** to select **C** (Standard stations) or **S** (Cable stations):  
C02 - C69, S01 - S41.  
Enter the channel number of station that you want to tune, use **▲** or **▼** to find the required station.

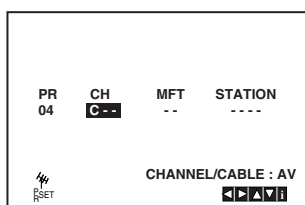

- Searching will stop when it locates a stations.  
Press **▶** to select **MFT**.  
Control the fine tuning of the station by using **▲** or **▼**.

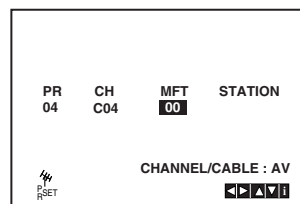

- Press **▶** to select **STATION** so that you may name your TV station.  
Press **ENTER/OK**.
- Use **▲** or **▼** to select **letters** and **numbers** for the station name.  
Use **◀** or **▶** to move back and forth between characters.  
Press **ENTER/OK**.

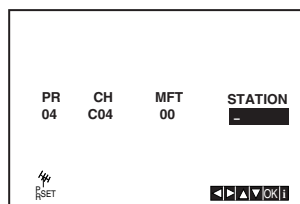

- Press **i**, confirm the station placement.

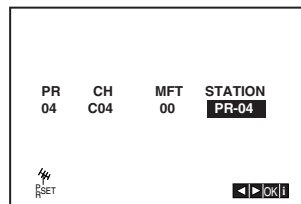

If you wish to manually tune other stations repeat stages **3 - 8**.

PR	CH	MFT	STATION
01	C01	00	PR-01
02	C02	00	PR-02
03	C03	00	PR-03
04	C04	00	PR-04
05	--	--	----
06	--	--	----
07	--	--	----
08	--	--	----

MOVE: **▶**  
DELETE: **◀**, **▲**, **▼**, **OK**, **⏏**

- Press **i** again.  
Your new TV station has now been tuned into your DVD+VCR.

## Changing the order of TV Stations

After tuning TV stations into your DVD+VCR you may wish to change the order in which they are stored without having to retune them again. The instructions given on this page will show you how you can simply move them into your desired order.

1. Press **i**.  
The main menu will appear on the TV screen.  
Press **◀** or **▶** to select the **PR SET**.  
Press **ENTER/OK**.

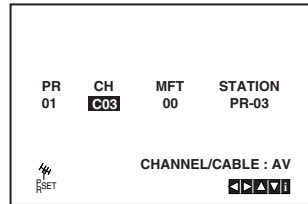
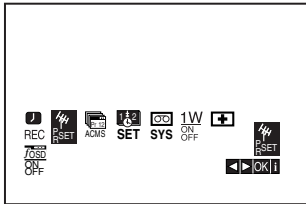

2. Press **i**.  
Press **▲** or **▼** to select the **programme number** you want to move (for example, PR-03).  
Press **▶**.

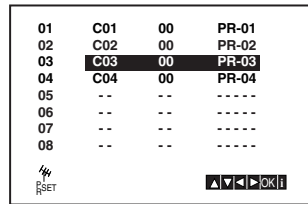
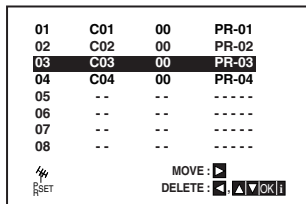

3. Press **▲** or **▼** to select the **programme number** you want to move to (for example, PR-05).

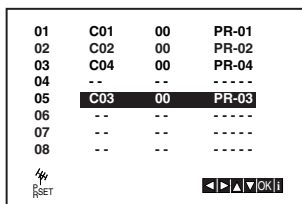

4. Press **ENTER/OK**.  
The selected **programme** will be moved to the **new programme number**.  
If you wish to move other TV stations repeat stages 1 - 4.

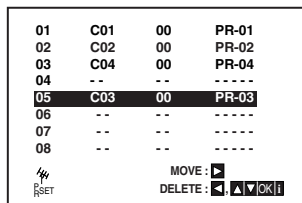

5. Press **i** to remove the menus from the TV screen.

## Deleting TV Stations

After tuning TV stations into your DVD+VCR you may wish to delete a station. The instructions given on this page will show you how you can easily delete any unwanted TV stations.

1. Press **i**.  
The main menu will appear on the TV screen.  
Use **◀** or **▶** to select the **PR SET**.  
Press **ENTER/OK**.

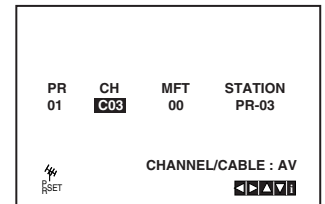
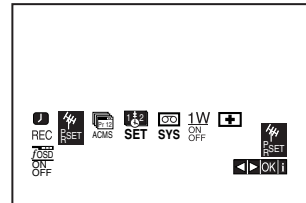

2. Press **i**.
3. Press **▲** or **▼** to select the **programme number** you want to delete. (for example, PR-01)

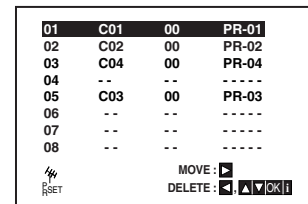

4. Press **◀**.  
After a short while, the selected station will be deleted.  
If you wish to delete other TV stations repeat stages 3 - 4.

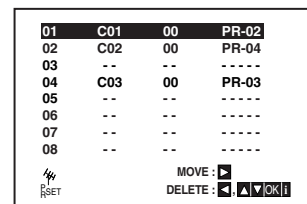

5. Press **i** to remove the menus from the TV screen.



### Displaying Disc Information on-screen

You can display various information about the disc loaded on-screen.

1. Press DISPLAY to show various playback information.  
The items displayed differ depending on the disc type or playing status.



2. You can select an item by pressing ▲ / ▼ and change or select the setting by pressing ◀ / ▶.
  - Title (Track) – Current title (or track) number/total number of titles (or tracks)
  - Chapter – Current chapter number/total number of chapters
  - Time – Elapsed playing time
  - Audio – Selected audio language or channel
  - Subtitle – Selected subtitle
  - Angle – Selected angle/total number of angles
  - Sound – Selected sound mode

#### Note:

If no button is pressed for a few seconds, the on-screen display disappears.

### Initial Settings

By using the DVD Setup menu, you can make various adjustments to items such as picture and sound. You can also set a language for the subtitles and the Setup menu, among other things. For details on each Setup menu item, see pages 16 to 19.

#### To display and exit the Menu:

Press SETUP to display the menu. A second press of SETUP will take you back to initial screen.

#### To go to the next level:

Press ▶ on the remote control.

#### To go back to the previous level:

Press ◀ on the remote control.

### General Operation

1. Press DVD on the remote control.

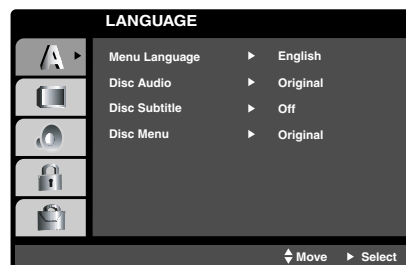

2. Press SETUP.  
The Setup menu appears.
3. Use ▲ / ▼ to select the desired option then press ▶ to move to the second level.  
The screen shows the current setting for the selected item, as well as alternate setting(s).
4. Use ▲ / ▼ to select the second desired option then press ▶ to move to the third level.
5. Use ▲ / ▼ to select the desired setting then press ENTER/OK to confirm your selection.  
Some items require additional steps.
6. Press SETUP or ▶ exit the Setup menu.

# Before Operation-DVD part

## LANGUAGE



### Menu Language

Select a language for the VCR and DVD's setup menu and information display.

### Disc Audio / Subtitle / Menu **DVD**

Select the language you prefer for the audio track (disc audio), subtitles, and the disc menu.

**Original:** Refers to the original language in which the disc was recorded.

**Other:** To select another language, press number buttons then ENTER/OK to enter the corresponding 4-digit number according to the language code list in the reference chapter (see page 34). If you enter the wrong language code, press CLEAR.

## DISPLAY

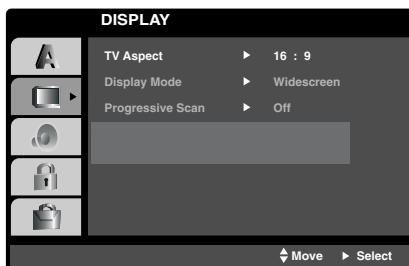

### TV Aspect **DVD**

**4:3 :** Select when a standard 4:3 TV is connected.

**16:9 :** Select when a 16:9 wide TV is connected.

### Display Mode **DVD**

Display Mode setting works only when the TV Aspect mode is set to "4:3".

**Letterbox:** Displays a wide picture with bands on the upper and lower portions of the screen.

**Panscan:** Automatically displays the wide picture on the entire screen and cuts off the portions that do not fit.

### Progressive Scan

Progressive Scan Video provides the highest quality pictures with less flickering.

If you are using the Component Video jacks for connection to a TV or monitor that is compatible with a progressive scan signal, set Progressive Scan to On.

#### To turn On progressive scan:

Connect component out of this unit to the input of your monitor/television, set your television or monitor to Component Input.

1. Select "Progressive Scan" on the DISPLAY menu then press ►.

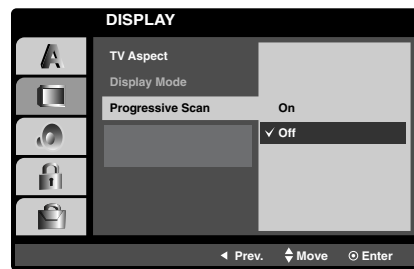

2. Select "On" using the ▲ / ▼ buttons.
3. Pressing ENTER/OK will set this unit to Progressive scan mode.

#### Caution:

Once the setting for progressive scan output is entered, an image will only be visible on a progressive scan compatible TV or monitor. If you set Progressive Scan to On in error, you must reset the unit.

- 1) Remove any disc from the unit and close the disc tray. See that "DISC" is displayed on the display window.
- 2) Press STOP on the remote control and hold it for five seconds before releasing it. The video output will be restored to the standard setting and a picture will once again be visible on a conventional analog TV or monitor.

## Before Operation-DVD part

### AUDIO

Each DVD disc has a variety of audio output options. Set this unit's AUDIO options according to the type of audio system you use.

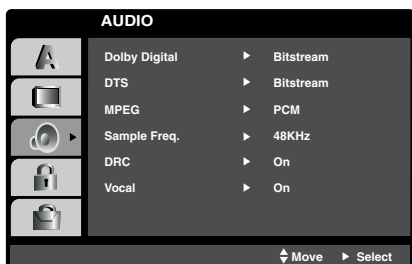

#### Dolby Digital / DTS / MPEG **DVD** **DivX**

**Bitstream:** Select "Bitstream" if you connect the DVD+VCR's DIGITAL AUDIO OUT jack to an amplifier or other equipment with a Dolby Digital, DTS or MPEG decoder.

**PCM (for Dolby Digital / MPEG):** Select when connected to a two-channel digital stereo amplifier. DVDs encoded in Dolby Digital or MPEG will be automatically downmixed to two-channel PCM audio.

**Off (for DTS):** If you select "Off", the DTS signal is not output through the DIGITAL AUDIO OUT jack.

#### Sample Freq. (Frequency) **DVD**

If your receiver or amplifier is NOT capable of handling 96 kHz signals, select 48 kHz. When this choice is made, this unit automatically converts any 96 kHz signals to 48 kHz so your system can decode them.

If your receiver or amplifier is capable of handling 96 kHz signals, select 96 kHz. When this choice is made, this unit passes each type of signal through without any further processing.

Check the documentation for your amplifier to verify its capabilities.

#### DRC (Dynamic Range Control) **DVD**

With the DVD format, you can hear a program's soundtrack in the most accurate and realistic presentation possible, thanks to digital audio technology. However, you may wish to compress the dynamic range of the audio output (the difference between the loudest sounds and the quietest ones). This allows you to listen to a movie at a lower volume without losing clarity of sound. Set DRC to On for this effect.

#### Vocal **DVD**

Set to On only when a multi-channel karaoke DVD is playing. The karaoke channels on the disc mix into normal stereo sound.

### LOCK (Parental Control)

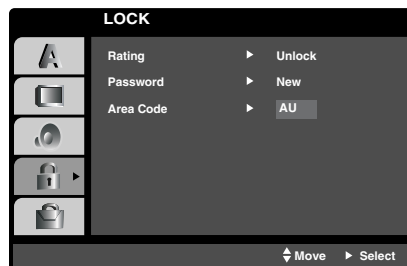

#### Rating

Blocks playback of rated DVDs based on their content. Not all discs are rated.

1. Select "Rating" on the LOCK menu then press ►.

2. To access the LOCK options, you must input the password you have created. If you have not yet entered password, you are prompted to do so.

Input a password and press ENTER/OK. Enter it again and press ENTER/OK to verify. If you make a mistake before pressing ENTER/OK, press CLEAR.

3. Select a rating from 1 to 8 using the ▲ / ▼ buttons.

**Rating 1-8:** Rating one (1) has the most restrictions and rating eight (8) is the least restrictive.

**Unlock:** If you select unlock, parental control is not active and the disc plays in full.

4. Press ENTER/OK to confirm your rating selection, then press SETUP to exit the menu.

#### Password

You can enter or change password.

1. Select Password on the LOCK menu then press ►.

2. Follow step 2 as shown above (Rating).

To change the password, press ENTER/OK when the "Change" option is highlighted. Input a password and press ENTER/OK. Enter it again and press ENTER/OK to verify.

3. Press SETUP to exit the menu.

If you forget your password

If you forget your password, you can clear it using the following steps:

1. Press SETUP to display the Setup menu.

2. Input the 6-digit number "210499" and press ENTER/OK. The password is cleared.

## Before Operation - DVD part

### Area Code **DVD**

Enter the Area Code whose standards were used to rate the DVD video disc, based on the list in the reference chapter (see page 34).

1. Select "Area Code" on the LOCK menu then press ►.
2. Follow step 2 as shown left (Rating).
3. Select the first character using ▲ / ▼ buttons.
4. Press ► and select the second character using ▲ / ▼ buttons.
5. Press ENTER/OK to confirm your area code selection.

### OTHERS

The PBC and Auto Play and Divx(R) settings can be changed.

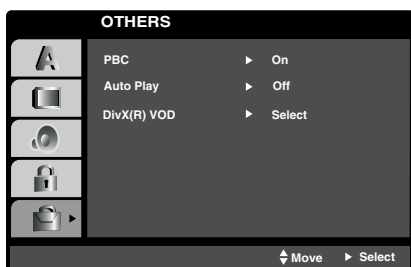

### PBC **VCD**

Set Playback Control (PBC) to On or Off.

**On:** Video CDs with PBC are played according to the PBC.

**Off:** Video CDs with PBC are played the same way as Audio CDs.

### Auto Play **DVD**

You can set up the DVD+VCR so a DVD disc automatically starts playing whenever the DVD is inserted. If Auto Play mode is set to On, this DVD player will search for title that has the longest playback time and then play back the title automatically.

#### **Note:**

The Auto Play function may not work for some DVDs.

### DivX(R) VOD

We provide you the DivX<sup>®</sup> VOD (Video On Demand) registration code that allows you to rent and purchase videos using the DivX<sup>®</sup> VOD service. For more information, visit [www.divx.com/vod](http://www.divx.com/vod).

1. Select "DivX(R) VOD" option then press ►.
2. Press ENTER/OK while "Select" is selected and the registration code will appear. Use the registration code to purchase or rent the videos from DivX<sup>®</sup> VOD service at [www.divx.com/vod](http://www.divx.com/vod). Follow the instructions and download the video onto a disc for playback on this unit.
3. Press ENTER/OK to exit.

#### **Note:**

All the downloaded videos from DivX<sup>®</sup> VOD can only be played back on this unit.

## Playing a tape

You will only be able to load and eject video cassettes when your DVD+VCR is plugged into the mains. Your DVD+VCR may also playback recordings from NTSC tapes (on PAL TV).

### Getting a better picture

When a cassette is inserted and playback started, the automatic tracking function works to get the best possible picture automatically. If the quality of the recording is poor, repeatedly press ▲ or ▼ on the remote control to manually adjust the tracking until any distortions have been removed.

1. Make sure that you have correctly connected your DVD+VCR as described earlier in this book.  
Turn on your TV.  
Press **OPERATE** to turn on your DVD+VCR.  
Insert the video cassette into your DVD+VCR.  
The video cassette should have the window side facing up and the arrow facing away from you.
2. Press ► to start playing your tape.  
If you load a video cassette which has had its record protection tab removed, playback of the cassette will start automatically.

### AUTO TRACKING

Your DVD+VCR will automatically adjust the tracking to give the best picture quality.

3. Press **PAUSE/STEP** to still a picture.  
Press **PAUSE/STEP** repeatedly to advance the tape frame by frame.  
If you press **FORWARD**, the picture will be slowed down at about 1/19 times the normal playback.  
Tapes can be paused for up to 5 minutes. After 5 minutes your DVD+VCR will stop the tape to prevent damaging the tape or your DVD+VCR.  
Still picture quality can be improved slightly by using ▲ or ▼.
4. Press ► to continue playing your tape.

### Double speed playback

Press the "►" button during normal playback. The tape will play back at double speed and without sound.

Press the "►" button to return to playback at normal speed

### Picture search:

During playing back press either **BACKWARD** or **FORWARD** to this will enable you to rapidly wind the tape see where you are on the tape.

### Logic search:

During fast forwarding or rewinding press and hold ◀◀ or ▶▶ the picture will be played back at 7 times normal playback speed.

### 5. Slow motion playback, Shuttle :

During playing back or still picture press ◀ or ▶.

You can reach the following playback speeds.

(REV, PB 5-, PB 1-, Still, SLW, PLAY, 2PLY, CUE)

To switch off the slow motion and shuttle, press the desired function.

During slow motion and shuttle, the noise bars may appear on the picture according to the status of tape.

If distortions can be seen in the picture, reduce them with ▲ or ▼.

### 6. Press **STOP** to end playback.

Press **EJECT**.

If the end of the tape is reached, your DVD+VCR will stop playback automatically, rewind, stop, eject the tape.

### CM (Commercial Message) Skip:

This feature enables you during playback of a tape to skip a commercial break in a few seconds, then resume normal playback.

While tape is playing press **SKIP ►►** on the remote control to skip commercial (or another programme material).

Repeatedly press **SKIP ►►** to skip:

- 1 Press 30 seconds
- 2 Press 60 seconds
- 3 Press 90 seconds
- 4 Press 120 seconds
- 5 Press 150 seconds
- 6 Press 180 seconds

### OPR (Optimum Picture Response)

This feature automatically improves playback picture quality by adjusting your DVD+VCR to the condition of the tape. Please note that the OPR icon (📺) will only appear in play that mode when playing a tape.

1. Press **i**.
2. Press ◀ or ▶ to select 📺 (OPR).
3. Press **ENTER/OK**.
4. Press ▲ or ▼ repeatedly to select: **OFF**, **SOFT** or **SHARP**. Please note you may only set OPR when playing a tape.
5. Press **i** return to screen.

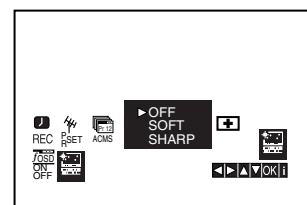

### Quick Set Recording (QSR)

Your DVD+VCR allows you to make recordings using a variety of simple methods:

**Quick Set Recording (QSG)** start recording immediately for a set period of time or until the video cassette runs out.

Your DVD+VCR incorporates Long Play (LP) which enables you to record up to twice the amount of time on a video cassette. For example an E-180 will record up to 180 minutes using Standard Play (SP); using LP you will be able to record up to 360 minutes. Please note there will be a slight loss in picture and sound quality when using LP.

1. Make sure that you have correctly connected your DVD+VCR as described earlier in this book. Press **OPERATE** to turn on your DVD+VCR.
2. Insert a video cassette with protection tab into your DVD+VCR.  
The video cassette should have the window side facing up and the arrow facing away from you.
3. Press **▲** or **▼** to select the **programme number** you wish to record.  
You may also directly select programme number using the **numbered buttons** on the remote control.
4. If you wish to record directly from the AUDIO L/R (VCR IN AV1)/ VIDEO (VCR IN AV1) or AUDIO IN (L(MONO)/R)/ VIDEO IN terminals repeatedly press **AV** until the socket you wish to record from is displayed.  
**AV 1** for recording from AUDIO L/R (VCR IN AV1)/ VIDEO (VCR IN AV1) terminals on the rear of your unit.  
**AV 2** for recording from AUDIO IN (L(MONO)/R)/ VIDEO IN terminals on the front of your unit.
5. Press **LONG PLAY** if you wish to record in Long Play or Standard Play.  
SP will produce improved picture and sound quality, however LP will provide twice as much recording time as SP.
6. Press **REC/QSR** on the remote to start recording. Press **REC/QSR** on the remote several times. Each successive press will increase the record time by 30 minutes until you reach a maximum of 9 hours.

7. Press **PAUSE/STEP** to avoid recording unwanted scenes.

Press **PAUSE/STEP** to continue recording.

Tapes can be paused for up to 5 minutes; RECP will be displayed when a tape is paused. After 5 minutes your DVD+VCR will stop recording to prevent damaging the tape or your DVD+VCR.

8. Press **STOP** to end recording.  
Press **EJECT**.

#### Notes:

- If you do not wish to record on a tape (this can happen quite easily by accident!) remove the protection tab on the back edge of the video cassette.
- It is possible to record on a video cassette with the record protection tab removed by covering the hole with self adhesive tape.
- Remember you can record one programme while watching another by starting your instant recording, press **TV/VCR** to select **TV** mode and then selecting a different channel on your TV.



## Operation with tape

### Timer recording using On Screen Display

You may set up to seven timer record events within one month of the current date.

#### Note:

Before setting the timer make sure that you have set the DVD+VCR clock correctly and you know which stations you have tuned TV stations on your DVD+VCR.

1. Insert a video cassette with protection tab into your DVD+VCR.  
The video cassette should have the window side facing up and the arrow facing away from you.

2. Press **i**.  
Press **◀** or **▶** to select **REC** (  ).  
Press **ENTER/OK**.

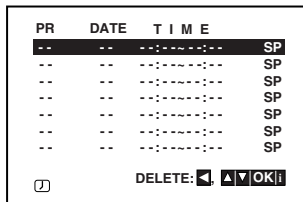

3. Press **ENTER/OK** to start setting the timer record event.
4. Use the CH/TRK (**▲/▼**) to enter the station that you wish to record then press **▶**.

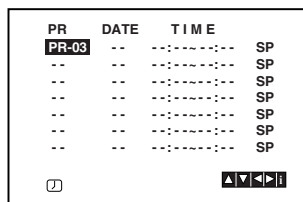

#### Note:

If all timer record events are full press **▲** or **▼** to select the event that you wish to remove and replace.  
Press **◀** to delete the event.

5. Use the CH/TRK (**▲/▼**) to enter the date of the programme.  
If you press **ENTER/OK** before entering the date you may select one of the following automated recording features.  
Press **◀** or **▶** to select, then press **ENTER/OK** to confirm.  
**DLY** To record every day (except Saturday and Sunday) at the same time.  
**SU~SA** To record at the same time every week.

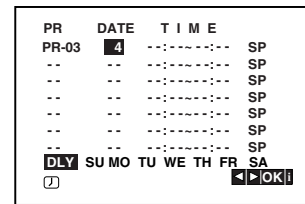

6. Use **▲/▼/◀/▶** buttons to enter the recording start and end times of the programme that you wish to record.

Please note your DVD+VCR uses a 24 hour clock. e.g. 1pm will be displayed as 13:00.

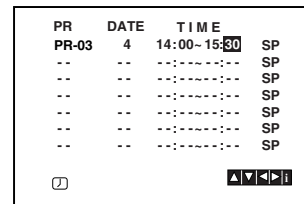

7. Press **▶** to select the recording speed.  
Press **▲** or **▼** to select the desired tape speed (SP, IP, or LP).  
IP mode determines how much tape is left and switches speed from SP to LP, if necessary, to complete recording the program.

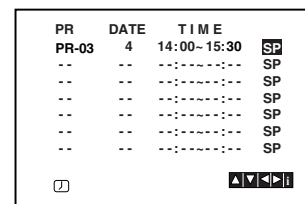



### Timer recording using On Screen Display (Continued)

- Press **i** to set another timer record event and follow steps 3 to 7.  
Check that the timer event details are correct.  
Press **i** return to screen.  
If **PLEASE CHECK** is displayed, you have entered incorrectly and will need to re-enter the data.
- Press **OPERATE** to switch your DVD+VCR to Timer Standby mode.

**Note:**

**The 1W Mode is not available in the standby mode for the timer recording.**

The timer symbol ( ⌚ ) will appear in the display window while your DVD+VCR waits to make the recording.

- Press **OPERATE** to end timer recording.

**Notes:**

- The DVD+VCR will automatically power off when Timer Recording ends.
- During timer recording standby mode, the DVD and VCR mode cannot be operated. To use the DVD+VCR, press **OPERATE**. After you use the DVD or VCR, press **OPERATE** again to put the VCR into timer recording standby mode.
- If at a later date you wish to **delete** or **change** any of the settings in timer event memory you may do so without having to enter all the timer event information again. Simply display the timer event screen. Use **▲** or **▼** to select the event that you wish to **delete** or **change**.

Press **◀** to delete the event...or

Press **ENTER/OK** to change; then press **◀** or **▶** to select; Station, Date, Start and End times and recording speed. Press **▲** or **▼** to enter the correct information.

- If Timer record events Overlap...**

Make sure that the preset times of the timer recording events do not overlap. If they do, the earlier programme will always be given priority.

**Example:**

Programme 1 is programmed to start at 16:00 and end at 17:00.

Programme 2 is programmed to start at 16:30 and end at 17:30.

(In this case, Programme 1 will be recorded in its entirety, but only the last 30 minutes of Programme 2 will be recorded.)

- To watch a DVD while performing a timer recording, press **DVD** to select DVD mode.

### Hi-Fi Stereo Sound System

This allows you to record and playback the sound in several different ways. Video cassettes recorded on your DVD+VCR will have a normal mono audio track and two VHS Hi-Fi stereo audio tracks. These stereo tracks allow you to make audio recordings in Hi-Fi stereo or bilingual mode from a TV broadcast, stereo audio system, video disc or another Hi-Fi VCR.

1. Your VCR's allows you to enjoy broadcasts with standard stereo, bilingual and mono sound. The particular type of sound received or that recorded will be briefly displayed on the TV screen for a couple of seconds:

#### **STEREO**

Sound is automatically recorded on the Hi-Fi stereo and mono tracks of the video tape.

#### **BIL**

Both audio channels will be recorded on the Hi-Fi stereo tracks. The primary language channel (left) will be recorded on the mono track of the video tape.

#### **MONO**

The sound is recorded on the Hi-Fi tracks and the mono track of the video tape without any separation.

2. Press **AUDIO** repeatedly until the desired audio mode appears.
3. The choice is **STEREO**, **LEFT**, **RIGHT** and **MONO**. In **BIL** playback the primary language is output on the left channel and the secondary channel is output simultaneously from the right channel when audio output is set to **STEREO**. The primary language will be output from both channels when the audio setting is **MONO**. Please note that when adjusting the tracking control Hi-Fi stereo sound may revert to **MONO**.

### On Screen Display (F.OSD)

You may easily display the current time or tape counter, amount of tape left, day, month, year, day of week, programme channel, tape speed and operational mode of your DVD+VCR on the TV screen. If a recording is taking place these On Screen Displays will not be recorded onto the tape.

1. Press **CLK/CTR** to display. Press **CLK/CTR** repeatedly to cycle through the display options. The tape counter and amount of tape left will appear if there is a tape loaded.
2. After 3 seconds the majority of the On Screen Displays will clear leaving only the clock or tape counter and the amount of tape left on the screen. Press **CLK/CTR** again to remove all displays from the TV screen.

### Tape Counter Memory Stop

The **Digital Tape Counter** can be displayed on the display window instead of the time by pressing **CLK/CTR** on the remote control. The Digital Tape Counter indicates the relative positions of recordings on the tape.

1. Press **CLK/CTR**. Press **CLEAR** to set the counter to 0:00:00. Press **▶** or start recording. The tape counter will display the actual play time in hours, minutes and seconds.
2. Press **■** when playback or recording is complete. Press **◀◀**. The tape will rewind and automatically stop when the counter returns to 0:00:00.

### Video Doctor (Self-Diagnosis)

This feature informs you that there is a problem with your DVD+VCR. These error messages will appear on the TV screen.

1. Press **i**.  
Press **◀** or **▶** to select **+**.  
Press **ENTER/OK**.

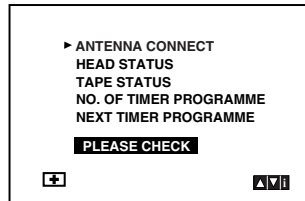
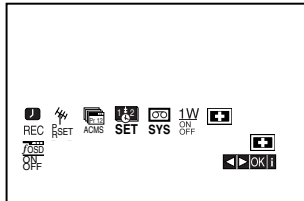

2. Press **▲** or **▼** to check a problem.

#### ANTENNA CONNECT

##### ● PLEASE CHECK:

Connect the aerial into the jack securely.

#### HEAD STATUS

##### ● PLEASE CLEAN:

Clean your video heads.

#### TAPE STATUS

##### ● NOT RECORDABLE:

Insert a tape with its protection tab in place

#### NO. OF TIMER PROGRAMME

##### ● 2

Shows the number of timer recording.

#### NEXT TIMER PROGRAMME

##### ● PR-01 26 10:00~11:00 SP

Shows the current status of timer recording.

3. Press **i** to remove the menus from the TV screen.

### 1W Mode (Power save Mode)

Set 1W ON/OFF to ON to place your DVD+VCR into an economic power save mode.

Nothing is displayed in the display window.

1. Press **i**.  
The main menu will appear on the TV screen.  
Press **◀** or **▶** to select the **1W ON/OFF**.  
Press **ENTER/OK**.
2. Press **▲** or **▼** to select the ON.
3. Press **i**.

#### Note:

Some function may not be operated in the 1W Mode.

- The 1W Mode is not available in the standby mode for the timer recording.

## Additional Operation - VCR part

### Recording from External Components

With this video recorder you can make recordings from an external source, such as copying from another video recorder or a camcorder.

#### Note:

In the following description, this video recorder will be one used for recording and will be referred to as VCR B. The other appliance will be used for playback and will be referred to as VCR A.

1. VCR A should be connected to the AUDIO L/R (VCR IN AV1)/VIDEO (VCR IN AV1) on the rear panel of your unit or AUDIO IN (L(MONO)/R) / VIDEO IN on the front panel of your unit.
2. Insert the recorded tape into VCR A and a blank tape into VCR B.
3. Press **AV** until the socket you wish to record from is displayed. (VCR B)

**AV 1** for recording from AUDIO L/R (VCR IN AV1)/VIDEO (VCR IN AV1) terminals on the rear of your unit.

**AV 2** for recording from AUDIO IN (L(MONO)/R)/VIDEO IN terminals on the front of your unit.

4. To start recording, press the REC/QSR on VCR B and PLAY on VCR A.
5. When you want to finish copying, press the STOP on both video recorders.

#### Notes:

- Before recording, confirm the recording start position.
- If your source is copy-protected using CopyGuard, you will not be able to record it using this unit. See Copyright on page 5 for more details.
- To record for a fixed length of time, see Instant Timer Recording.

### Copying from DVD to VCR

You can copy the contents of a DVD to a VHS tape.

1. Insert the disc you wish to copy into the DVD deck and close the disc tray.
2. Insert a blank VHS video tape into the VCR deck.
3. Find the place on the DVD from which you want to start dubbing using the **▶**, BACKWARD, FORWARD and PAUSE functions.  
For best results, pause playback at the point from which you want to record.
4. Press REC/QSR on the Remote Control.  
The DVD goes into PLAY mode and the VCR goes into RECORD mode. If the DVD disc menu appears, you may need to press **▶** manually to begin copying.
5. When the DVD is finished playing, press STOP to end copying.

#### Notes:

- If the DVD you are attempting to copy is copy protected, you will not be able to copy the disc. It is not permitted to copy Macrovision encoded DVDs (or Discs). "LOCK" is displayed in the display window.
- You must stop the copy process manually when the DVD movie ends, or the unit may replay and record over and over again.
- When you stop the DVD playback during copying, the recording on VCR is stopped automatically.

## General Playback features - DVD Part

Buttons	Operations	Discs
(OPEN / CLOSE)	Opens or closes the disc tray.	<b>ALL</b>
(PAUSE)	During playback, press  to pause playback. Press  repeatedly to play Frame-by-Frame.	<b>ALL</b> <b>DVD</b> <b>VCD</b> <b>DivX</b>
/	During playback, press  or  to go to the next chapter/track or to return to the beginning of the current chapter/track. Press  twice briefly to step back to the previous chapter/track.	<b>ALL</b>
/	During playback, press  or  repeatedly to select the required scan speed. DVD, DivX disc; 4 steps Video CD, MP3, WMA, Audio CD ; 3 steps	<b>ALL</b>
	While the playback is paused, press  repeatedly to play in slow motion (4 steps, forward only).	<b>DVD</b> <b>VCD</b> <b>DivX</b>
REPEAT	During playback, press REPEAT repeatedly to select a desired repeat mode. DVD Video discs: Chapter/Title/Off Video CD, Audio CD, DivX/MP3/WMA discs: Track/All/Off	<b>ALL</b>
A-B	During playback, each press of A-B button to select point A and point B and repeats a sequence from point A (Starting point) to point B (End point). Press CLEAR to exit.	<b>DVD</b> <b>VCD</b> <b>DivX</b> <b>ACD</b>
ZOOM	During playback or pause mode, press ZOOM to enlarge the video image (4 steps). You can move through the zoomed picture using     buttons. Press CLEAR to exit.	<b>DVD</b> <b>VCD</b> <b>DIVX</b>
RANDOM	During playback or in stop mode, press RANDOM for random playback.	<b>ACD</b> <b>MP3</b> <b>WMA</b>
TITLE	If the current DVD title has a menu, the title menu appears on the screen. Otherwise, the disc menu may appears.	<b>DVD</b>
DISC MENU	The disc menu appears on the screen.	<b>DVD</b>
(ANGLE)	During playback of DVD disc contains scenes recorded different camera angles, press ANGLE repeatedly to select a desired angle.	<b>DVD</b>
(SUBTITLE)	During playback, press SUBTITLE repeatedly to select a desired subtitle language.	<b>DVD</b> <b>DivX</b>
(AUDIO)	During playback, press AUDIO repeatedly to hear a different audio language or audio track.	<b>DVD</b> <b>DivX</b> <b>VCD</b>

# Playing a DVD or Video CD

## Notes on general features:

- On a Video CD with PBC, you must set PBC to Off on the setup menu to use the repeat function (See “PBC” on page 19).
- If you press ►► once during Repeat Chapter (Track) playback, the repeat playback cancels.
- Zoom may not work on some DVDs.
- When you are playing a DVD disc contains scenes recorded different camera angles, the angle indicator will blink on the TV screen during scenes recorded at different angles as an indication that angle switching is possible.
- The A-B repeat function is available only in the current chapter/track.

## Additional features

### 3D Surround

To produce a 3D surround effect that simulates multi-channel audio from two stereo speakers (instead of the five+ speakers normally required for multi-channel audio from a home theater system).

**DVD** **VCD** **DivX**

1. Press DISPLAY during playback.
2. Use ▲ or ▼ to select the sound option. The sound option will be highlighted.
3. Use ◀ or ▶ to select “3D SUR”. To turn off the 3D Surround effect, select “Normal”.

**ACD**

1. Press AUDIO during playback. “3D SUR.” appears on the menu screen.
2. To return to normal playback, press AUDIO repeatedly until “3D SUR.” disappears from the menu screen.

### Time Search **DVD** **VCD** **DivX**

To start playing at any chosen time on the disc:

1. Press DISPLAY during playback.
2. Press ▲ / ▼ to select the time clock icon and “--:--:--” appears.
3. Use numerical buttons to input the required start time in hours, minutes, and seconds from left to right. If you enter the wrong numbers, press CLEAR to remove the numbers you entered. Then input the correct numbers.
4. Press ENTER to confirm. Playback starts from the selected time.

### Marker Search **DVD** **VCD** **DivX**

#### To enter a Marker

You can start playback from up to nine memorized points. To enter a marker, press MARKER at the desired point on the disc. The Marker icon appears on the TV screen briefly. Repeat to enter up to nine markers.

#### To Recall or Clear a Marked Scene

1. During disc playback, press SEARCH. The marker search menu appears on the screen.
2. Within 10 seconds, press ◀ / ▶ to select a marker number that you want to recall or clear.
3. Press ENTER and playback starts from the marked scene. Or, Press CLEAR and the marker number is erased from the list.
4. You can play any marker by inputting its number on the marker search menu.

### Last Scene Memory **DVD** **ACD** **VCD**

This player memorizes last scene from the last disc that is viewed. The last scene remains in memory even if you remove the disc from the player or switch off the player. If you load a disc that has the scene memorized, the scene is automatically recalled.

#### Note:

This player does not memorize the scene of a disc if you switch off the player before commencing to play the disc.

### Screen Saver

The screen saver appears when you leave the DVD player in Stop mode for about five minutes.

# Playing an Audio CD or MP3/WMA file

This unit can play Audio CDs or MP3/WMA files recorded media.

## MP3/WMA/ Audio CD

Once you insert an MP3/WMA files recorded media or Audio CD, a menu appears on the TV screen.

Press ▲ / ▼ to select a track/file then press PLAY or ENTER and playback starts. You can use variable playback functions. Refer to page 27-28.

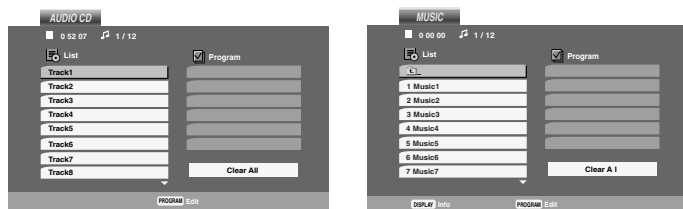

## ID3 TAG

- When playing a file containing information such as track titles, you can see the information by pressing DISPLAY.

[ Song, Artist, Album, Comment, Genre ]

## Tips:

- Press DISC MENU to move to the next page.
- On a CD with MP3/WMA and JPEG you can switch MP3/WMA and JPEG. Press TITLE and MUSIC or PHOTO word on top of the menu is highlighted.

### MP3 / WMA disc compatibility with this player is limited as follows:

- Sampling frequency: within 8 - 48 kHz (MP3), within 32 - 48kHz (WMA)
- Bit rate: within 8 - 320kbps (MP3), 32 - 384 kbps (WMA)
- The player cannot read an MP3/WMA file that has a file extension other than “.mp3” / “.wma”.
- CD-R physical format should be ISO 9660
- If you record MP3 / WMA files using software that cannot create a file system (eg. Direct-CD) it is impossible to playback MP3 / WMA files. We recommend that you use Easy-CD Creator, which creates an ISO 9660 file system.
- File names should have a maximum of 8 letters and must incorporate an .mp3 or .wma extension.
- They should not contain special letters such as / ? \* . < > | etc.
- The total number of files in a folder should be less than 1190 files.

## Programmed Playback

The program function enables you to store your favorite tracks from any disc in the player memory. A program can contain 30 tracks.

- Insert an Audio CD or MP3/WMA files recorded media. AUDIO CD or MUSIC menu appears.
- Press PROGRAM. The Ⓢ mark will appear.

### Note:

Press PROGRAM again to exit the program edit mode, then the Ⓢ mark will disappear.

- Select a track on the “List”, then press ENTER to place the selected track on the “Program” list. Repeat to place additional tracks on the list.
- Select the track you want to start playing on the “Program” list.
- Press PLAY or ENTER to start. Playback begins in the order in which you programmed the tracks. Playback stops after all of the tracks on the “Program” list have played once.
- To resume normal playback from programmed playback, select a track on the list and then press PLAY.

## Repeat Programmed Tracks

Press REPEAT to select a desired repeat mode.

- Track: repeats the current track
- All: repeats all the tracks on the “Program” list.
- Off(No display): does not play repeatedly.

### Note:

If you press ►► once during Repeat Track playback, the repeat playback cancels.

## Erasing a Track from “Program” List

- During STOP mode, press PROGRAM and the Ⓢ mark will appear
- Use ▲ ▼ ◀ ▶ to select the track that you wish to erase from the Program list.
- Press CLEAR. Repeat step 1~3 to erase additional tracks on the list.

## Erasing the Complete Program List

- During STOP mode, press PROGRAM and the Ⓢ mark will appear
- Use ▲ ▼ ◀ ▶ to select “Clear All”, then press ENTER.

### Note:

The programs are also cleared when the power is off or the disc is removed.



## Viewing a JPEG file

This unit can play JPEG files recorded media.

1. Insert a JPEG files recorded media. The PHOTO menu appears on the TV screen.

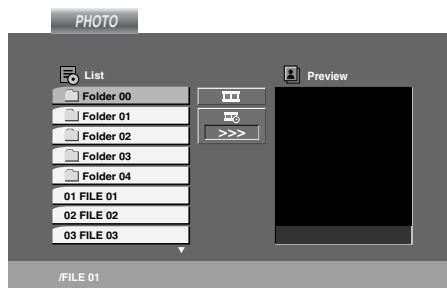

2. Press ▲ / ▼ to select a folder, and press ENTER. A list of files in the folder appears.
3. If you want to view a particular file, press ▲ / ▼ to highlight a file and press ENTER or PLAY.
4. To return to the PHOTO menu while watching pictures, press STOP.

### Tips:

- If you are in a file list and want to return to the previous Folder list, use ▲ / ▼ buttons to highlight and press ENTER.
- Press DISC MENU to move to the next page.
- There are three Slide Speed options : >>> (Fast), >> (Normal) and > (Slow).  
Use ▲ ▼ ◀ ▶ to highlight . Then, use ◀ / ▶ to select the option you want to use then press ENTER.
- On a disc with MP3/WMA and JPEG you can switch MP3/WMA and JPEG. Press TITLE and MUSIC or PHOTO word on top of the menu is highlighted.
- While watching a picture, press RETURN to hide the help menu.

### Slide Show

Use ▲ ▼ ◀ ▶ to highlight the (Slide Show) then press ENTER.

### Still Picture

1. Press PAUSE/STEP during slide show.  
The player will now go into PAUSE mode.
2. To return to the slide show, press PLAY or press PAUSE/STEP again.

### Moving to another File

Press ◀◀ or ▶▶ or cursor (◀ or ▶) once while viewing a picture to advance to the next or previous file.

### Zoom

During watching pictures, press ZOOM to enlarge the video image (4 steps).

You can move through the zoomed picture using ◀ ▶ ▲ ▼ buttons.

### To rotate picture

Press ▲ / ▼ during showing a picture to rotate the picture clockwise or counter clockwise.

### JPEG disc compatibility with this player is limited as follows:

- Depending upon the size and number of JPEG files, it could take a long time for this unit to read the disc's contents. If you do not see an on-screen display after several minutes, some of the files may be too large — reduce the resolution of the JPEG files to less than 5 million pixels and burn another disc.
- The total number of files in a folder should be less than 1190 files.
- Some discs may be incompatible due to a different recording format or the condition of disc.
- Ensure that all the selected files have the “.jpg” extensions when copying into the CD layout.
- If the files have “.jpe” or “.jpeg” extensions, please rename them as “.jpg” file.
- File names without “.jpg” extension will not be able to be read by this unit. Even though the files are shown as JPEG image files in Windows Explorer.

# Playing a DivX Movie file

Using this DVD Player you can play DivX file.

1. Insert a DivX file recorded media. The MOVIE menu appears on the TV screen.

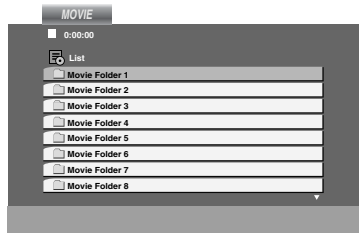

2. Press ▲ / ▼ to select a folder, and press ENTER. A list of files in the folder appears.
3. If you want to view a particular file, press ▲ / ▼ to highlight a file and press ENTER or PLAY. You can use variable playback functions. Refer to page 27-28.
4. Press STOP to stop the playback. The Movie menu appears

## Tips:

- If you are in a file list and want to return to the previous Folder list, use the ▲ / ▼ buttons on the remote to highlight  and press ENTER.
- Press DISC MENU to move to the next page.
- On a CD with MP3/WMA, JPEG and MOVIE file, you can switch MUSIC, PHOTO and MOVIE menu. Press TITLE and MUSIC, PHOTO and MOVIE word on top of the menu is highlighted.
- The picture may not displayed properly while DivX playback. Set your TV system to AUTO or PAL-60 mode to restore the picture, if available.
- The disc subtitle may not be displayed properly, if a DivX subtitle is downloaded through the internet.
- If the Disc Subtitle setup menu does not have the DivX subtitle language you are going to play, the subtitle may not be displayed properly.

## Notice for displaying the DivX subtitle

If the subtitle does not display properly during playback, press and hold SUBTITLE about 3 seconds then press ◀ / ▶ to select another language code until the subtitle is displayed properly.

## DivX disc compatibility with this player is limited as follows:

- Available resolution size of the DivX file is under 720x576 (W x H) pixel.
- The file name of the DivX subtitle is available by 56 characters.
- If there is impossible code to express in the DivX file, it may be displayed as " \_ " mark on the display.
- **If the number of the screen frame is over 30 per 1 second, this unit may not operate normally.**
- **If the video and audio structure of recorded file is not interleaved, either video or audio is out-putted.**
- **If the file is recorded with GMC, the unit supports only 1-point of the record level.**
  - \* GMC?  
GMC is the acronym for Global Motion Compensation. It is an encoding tool specified in MPEG4 standard. Some MPEG4 encoders, like DivX or Xvid, have this option. There are different levels of GMC encoding, usually called 1-point, 2-point, or 3-point GMC.

## Playable DivX file

.avi, .mpg, .mpeg

## Playable Subtitle format

SubRip(\*.srt/\*.txt)  
SAMI(\*.smi)  
SubStation Alpha(\*.ssa/\*.txt)  
MicroDVD(\*.sub/\*.txt)  
SubViewer 1.0(\*.sub)  
SubViewer 2.0(\*.sub/\*.txt)  
TMPlayer(\*.txt)

## Playable Codec format

"DIVX3.xx ", "DIVX4.xx ", "DIVX5.xx ", "XVID ",  
"MP43 ", "3IVX "

## Playable Audio format

- "Dolby Digital ", "DTS ", "PCM ", "MP3 ", "WMA "
- Sampling frequency: within 8 - 48 kHz (MP3), within 32 - 48kHz (WMA)
  - Bit rate: within 8 - 320kbps (MP3), 32 - 192kbps (WMA)
  - Not all the WMA Audio format is compatible with this unit.

## Playing a DVD VR format Disc

This unit will play DVD-R/RW discs recorded using the DVD-Video format that have been finalized using a DVD-recorder.

- This unit will play DVD-RW discs recorded using the Video Recording (VR) format.

1. Insert a disc and close the tray, It start playing automatically.
2. The DVD-VR menu appears on the TV screen when you press DISC MENU buttons while playing.

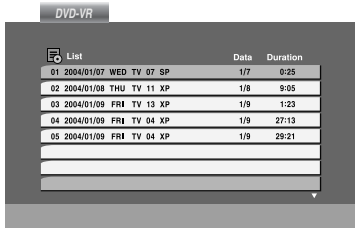

3. Press ▲ / ▼ to select a track then press PLAY or ENTER and playback starts.
4. Press DISC MENU to move to the list menu.

### Note:

- Unfinalized DVD-R/RW discs cannot be played in this player.
- Some DVD-VR disc are made with CPRM data by DVD RECORDER. Player does not support these kinds of discs.

### What is 'CPRM'?

CPRM is a copy protection system (with scramble system) only allowing the recording of 'copy once' broadcast programs. CPRM stands for Content Protection for Recordable Media. This player is CPRM compatible, which means that you can record copy-once broadcast programs, but you cannot then make a copy of those recordings. CPRM recordings can only be made on DVD-RW discs formatted in VR mode, and CPRM recordings can only be played on players that are specifically compatible with CPRM.

### Maintenance and Service

Refer to the information in this chapter before contacting a service technician.

#### Handling the Unit

##### When shipping the unit

Please save the original shipping carton and packing materials. If you need to ship the unit, for maximum protection, re-pack the unit as it was originally packed at the factory.

##### Keeping the exterior surfaces clean

- Do not use volatile liquids such as insecticide spray near the unit.
- Do not leave rubber or plastic products in contact with the unit for a long period of time. since they leave marks on the surface.

##### Cleaning the unit

To clean the player, use a soft, dry cloth. If the surfaces are extremely dirty, use a soft cloth lightly moistened with a mild detergent solution.

Do not use strong solvents such as alcohol, benzine, or thinner, as these might damage the surface of the unit.

##### Maintaining the Unit

The DVD+VCR is a high-tech, precision device. If the optical pick-up lens and disc drive parts are dirty or worn, the picture quality could be diminished.

Depending on the operating environment, regular inspection and maintenance are recommended after every 1,000 hours of use.

For details, please contact your nearest authorized service center.

# Language and Area Code List

## Language Code List

Use this list to input your desired language for the following initial settings: Disc Audio, Disc Subtitle, Disc Menu.

Language	Code	Language	Code	Language	Code	Language	Code
Abkhazian	6566	Fiji	7074	Lingala	7678	Singhalese	8373
Afar	6565	Finnish	7073	Lithuanian	7684	Slovak	8375
Afrikaans	6570	French	7082	Macedonian	7775	Slovenian	8376
Albanian	8381	Frisian	7089	Malagasy	7771	Somali	8379
Ameharic	6577	Galician	7176	Malay	7783	Spanish	6983
Arabic	6582	Georgian	7565	Malayalam	7776	Sudanese	8385
Armenian	7289	German	6869	Maltese	7784	Swahili	8387
Assamese	6583	Greek	6976	Maori	7773	Swedish	8386
Aymara	6588	Greenlandic	7576	Marathi	7782	Tagalog	8476
Azerbaijani	6590	Guarani	7178	Moldavian	7779	Tajik	8471
Bashkir	6665	Gujarati	7185	Mongolian	7778	Tamil	8465
Basque	6985	Hausa	7265	Nauru	7865	Tatar	8484
Bengali; Bangla	6678	Hebrew	7387	Nepali	7869	Telugu	8469
Bhutani	6890	Hindi	7273	Norwegian	7879	Thai	8472
Bihari	6672	Hungarian	7285	Oriya	7982	Tibetan	6679
Breton	6682	Icelandic	7383	Panjabi	8065	Tigrinya	8473
Bulgarian	6671	Indonesian	7378	Pashto, Pushto	8083	Tonga	8479
Burmese	7789	Interlingua	7365	Persian	7065	Turkish	8482
Byelorussian	6669	Irish	7165	Polish	8076	Turkmen	8475
Cambodian	7577	Italian	7384	Portuguese	8084	Twi	8487
Catalan	6765	Japanese	7465	Quechua	8185	Ukrainian	8575
Chinese	9072	Javanese	7487	Rhaeto-Romance	8277	Urdu	8582
Corsican	6779	Kannada	7578	Rumanian	8279	Uzbek	8590
Croatian	7282	Kashmiri	7583	Russian	8285	Vietnamese	8673
Czech	6783	Kazakh	7575	Samoan	8377	Volapük	8679
Danish	6865	Kirghiz	7589	Sanskrit	8365	Welsh	6789
Dutch	7876	Korean	7579	Scots Gaelic	7168	Wolof	8779
English	6978	Kurdish	7585	Serbian	8382	Xhosa	8872
Esperanto	6979	Laothian	7679	Serbo-Croatian	8372	Yiddish	7473
Estonian	6984	Latin	7665	Shona	8378	Yoruba	8979
Faroese	7079	Latvian, Lettish	7686	Sindhi	8368	Zulu	9085

## Area Code List

Choose a area code from this list.

Area	Code	Area	Code	Area	Code	Area	Code
Afghanistan	AF	Ethiopia	ET	Malaysia	MY	Saudi Arabia	SA
Argentina	AR	Fiji	FJ	Maldives	MV	Senegal	SN
Australia	AU	Finland	FI	Mexico	MX	Singapore	SG
Austria	AT	France	FR	Monaco	MC	Slovak Republic	SK
Belgium	BE	Germany	DE	Mongolia	MN	Slovenia	SI
Bhutan	BT	Great Britain	GB	Morocco	MA	South Africa	ZA
Bolivia	BO	Greece	GR	Nepal	NP	South Korea	KR
Brazil	BR	Greenland	GL	Netherlands	NL	Spain	ES
Cambodia	KH	Islands	HM	Netherlands Antilles	AN	Sri Lanka	LK
Canada	CA	Hong Kong	HK	New Zealand	NZ	Sweden	SE
Chile	CL	Hungary	HU	Nigeria	NG	Switzerland	CH
China	CN	India	IN	Norway	NO	Taiwan	TW
Colombia	CO	Indonesia	ID	Oman	OM	Thailand	TH
Congo	CG	Israel	IL	Pakistan	PK	Turkey	TR
Costa Rica	CR	Italy	IT	Panama	PA	Uganda	UG
Croatia	HR	Jamaica	JM	Paraguay	PY	Ukraine	UA
Czech Republic	CZ	Japan	JP	Philippines	PH	United States	US
Denmark	DK	Kenya	KE	Poland	PL	Uruguay	UY
Ecuador	EC	Kuwait	KW	Portugal	PT	Uzbekistan	UZ
Egypt	EG	Libya	LY	Romania	RO	Vietnam	VN
El Salvador	SV	Luxembourg	LU	Russian Federation	RU	Zimbabwe	ZW

# Troubleshooting

Check the following guide for the possible cause of a problem before contacting service.

Symptom	Cause	Correction
No power.	<ul style="list-style-type: none"> <li>The power cord is disconnected.</li> </ul>	<ul style="list-style-type: none"> <li>Plug the power cord into the wall outlet securely.</li> </ul>
The power is on, but the DVD player does not work.	<ul style="list-style-type: none"> <li>No disc is inserted.</li> </ul>	<ul style="list-style-type: none"> <li>Insert a disc.</li> </ul>
No picture.	<ul style="list-style-type: none"> <li>The TV is not set to receive this unit's signal output.</li> </ul>	<ul style="list-style-type: none"> <li>Select the appropriate video input mode on the TV so the picture from the this unit appears on the TV screen.</li> </ul>
	<ul style="list-style-type: none"> <li>The video cable is not connected securely.</li> </ul>	<ul style="list-style-type: none"> <li>Connect the video cable into the jacks securely.</li> </ul>
	<ul style="list-style-type: none"> <li>The Progressive Scan is set to "On" on the setup menu but is connected to a standard (analog) television.</li> </ul>	<ul style="list-style-type: none"> <li>Set Progressive Scan to "Off" (see page 17).</li> </ul>
No sound.	<ul style="list-style-type: none"> <li>The equipment connected with the audio cable is not set to receive DVD signal output.</li> </ul>	<ul style="list-style-type: none"> <li>Select the correct input mode of the audio receiver so you can listen to the sound from the this unit.</li> </ul>
	<ul style="list-style-type: none"> <li>The audio cables are not connected securely.</li> </ul>	<ul style="list-style-type: none"> <li>Connect the audio cable into the jacks securely.</li> </ul>
	<ul style="list-style-type: none"> <li>The power of the equipment connected with the audio cable is turned off.</li> </ul>	<ul style="list-style-type: none"> <li>Turn on the equipment connected with the audio cable.</li> </ul>
	<ul style="list-style-type: none"> <li>The Audio option is set to the wrong position.</li> </ul>	<ul style="list-style-type: none"> <li>Set the Audio option to the correct position, then turn on the DVD player again by pressing OPERATE.</li> </ul>
The picture is poor.	<ul style="list-style-type: none"> <li>The disc is dirty.</li> <li>The TV channels are not tuned in properly.</li> </ul>	<ul style="list-style-type: none"> <li>Clean the disc.</li> <li>Check tuning, carry out tuning again.</li> </ul>
The DVD player does not start playback.	<ul style="list-style-type: none"> <li>An unplayable disc is inserted.</li> </ul>	<ul style="list-style-type: none"> <li>Insert a playable disc. (Check the disc type and Regional code.)</li> </ul>
	<ul style="list-style-type: none"> <li>The disc is placed upside down.</li> </ul>	<ul style="list-style-type: none"> <li>Place the disc with the playback side down.</li> </ul>
	<ul style="list-style-type: none"> <li>The disc is not placed within the guide.</li> </ul>	<ul style="list-style-type: none"> <li>Place the disc on the disc tray correctly inside the guide.</li> </ul>
	<ul style="list-style-type: none"> <li>The disc is dirty.</li> </ul>	<ul style="list-style-type: none"> <li>Clean the disc.</li> </ul>
	<ul style="list-style-type: none"> <li>The Rating level is set.</li> </ul>	<ul style="list-style-type: none"> <li>Cancel the Rating function or change the rating level.</li> </ul>
The remote control does not work properly.	<ul style="list-style-type: none"> <li>There is an obstacle in the path of the remote control and this unit.</li> </ul>	<ul style="list-style-type: none"> <li>Remove the obstacle.</li> </ul>
	<ul style="list-style-type: none"> <li>The batteries in the remote control are exhausted.</li> </ul>	<ul style="list-style-type: none"> <li>Replace the batteries with new ones.</li> </ul>
Video tape cannot be inserted.	<ul style="list-style-type: none"> <li>Is the cassette compartment empty?</li> </ul>	<ul style="list-style-type: none"> <li>Eject the tape in.</li> </ul>
No Hi-Fi sound	<ul style="list-style-type: none"> <li>Audio mode is not set properly.</li> </ul>	<ul style="list-style-type: none"> <li>Select "STEREO" by repeatedly pressing "AUDIO" on the remote control.</li> </ul>

# Specification

## General

Power requirements	AC 200-240V, 50/60 Hz
Power consumption	17W
Dimensions (approx.)	430 x 78.5 x 265 mm (W x H x D)
Mass (approx.)	4.2 kg
Operating temperature	5°C to 35°C (41°F to 95°F)
Operating humidity	5 % to 90 %
Timer	24 hours display type
RF Modulator	UHF 28 - 68 (Adjustable)

## System

Laser	Semiconductor laser, wavelength 650 nm
Video Head system	Double azimuth 6 heads, helical scanning.
Signal system	PAL
Frequency response	DVD (PCM 96 kHz): 8 Hz to 44 kHz DVD (PCM 48 kHz): 8 Hz to 22 kHz CD: 8 Hz to 20 kHz
Signal-to-noise ratio	More than 100dB (ANALOG OUT connectors only)
Harmonic distortion	Less than 0.008%
Dynamic range	More than 100 dB (DVD) More than 95 dB (CD)

## Inputs (VCR)

Audio	-6.0dBm, more than 47 kohms
Video	1.0 Vp-p, 75 ohms, unbalanced

## Outputs (DVD)

VIDEO OUT	1 Vp-p 75 ohms, sync negative
S-VIDEO OUT	(Y) 1.0 Vp-p 75 ohms, negative sync., Mini Din 4-pin x 1 (C) 0.3 Vp-p 75 ohms
COMPONENT VIDEO OUT (Progressive Scan)	(Y) 1.0 V (p-p), 75 Ω, negative sync, RCA jack x 1 (Pb)/(Pr) 0.7 V (p-p), 75 Ω, RCA jack x 2
RGB output	0.7 Vp-p, 75 ohms
Audio output (coaxial audio)	0.5 V (p-p), 75 Ω, RCA jack x 1
Audio output (analog audio)	2.0 Vrms (1 KHz, 0 dB), 600 Ω, RCA jack (L, R)x2

## Outputs (VCR)

Audio	-6.0dBm, less than 1 kohms
Video	1.0Vp-p, 75 ohms, unbalanced
RGB output	0.7 Vp-p, 75 ohms

- Design and specifications are subject to change without notice.



# NEC

**NEC Australia Pty Ltd  
A.B.N. 86 001 217 527  
Home Electronics Group**

---

## **NEC Service Centres**

**PH: 131-632**

### **New South Wales**

Sydney	184 Milperra Rd, Revesby, 2212	(02) 9780-8688
Newcastle	120 Parry Street, Newcastle West, 2302	(02) 4926-2466

### **Victoria**

Melbourne	Unit 1/6 Garden Road, Clayton 3168	(03) 8562-6245
-----------	------------------------------------	----------------

### **Queensland**

Brisbane	Unit 4/305 Montague Road, West End 4101	(07) 3840-5858
Southport	Shop 1, 48 Ferry Road, Southport, 4215	(07) 5591-3670

### **South Australia**

Adelaide	84A Richmond Rd, Keswick, 5053	(08) 8375-5710
----------	--------------------------------	----------------

### **Western Australia**

Perth	45 Sarich Court, Osborne Park, 6017	(08) 9445-5901
-------	-------------------------------------	----------------

For service in outer areas, please contact your NEC retailer for the address of the nearest NEC Australia Pty. Ltd. Authorized Service Centre.

---

### **NEC Australia Pty Ltd**

244 Beecroft Road EPPING 2121  
Tel. 131-632 Fax. (02) 9877 2353

**NEC**