

A-9211

Integrated Stereo Amplifier

Instruction Manual

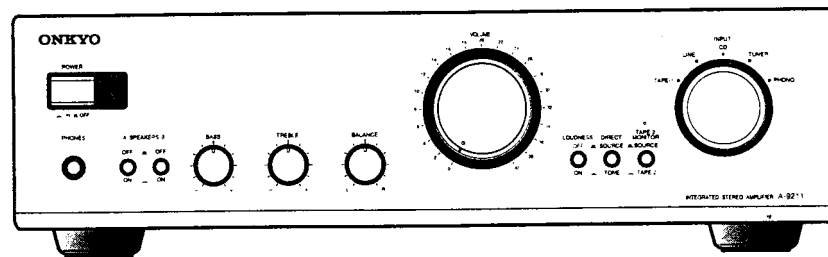

CONTENTS

Features	2
Important safeguards	3
Precautions	3
Control positions and names	4
System connections	6
Operations	8
Recording	10
Connecting a graphic equalizer	11
Troubleshooting guide	12
Specifications	12

Thank you for your purchase of the Onkyo A-9211 Amplifier. Please read this manual thoroughly before making connections and turning power on. Following the instructions in this manual will enable you to obtain optimum performance and listening enjoyment from your new A-9211. Please retain this manual for future reference.

Features

■ Plenty of Pristine Power

With 40 watts per channel into 8 ohms, 20 Hz to 20 kHz, 0.08% THD (dynamic power: 80 watts/ch into 4 ohms), you'll have ample muscle to drive virtually any speakers, and produce dynamically rich music, even at low volume levels.

■ Discrete Amplifiers

Rather than inexpensive hybrid IC "power packs" found in some conventional amps, your A-9211 uses costly, discrete amplifiers to drive each channel. In conjunction with the heavy-duty transformers and large chemical capacitors, discrete outputs help the A-9211 excel at accurately driving the most demanding low-impedance loads.

■ Simple, Direct Signal Paths

To further reduce the possibility of noise or interference from entering the signal, the signal paths are as short, direct and simple as possible.

■ RI Compatible Remote Control

■ Useful Extras You'll Enjoy

- 5 audio inputs
- Heavy-duty, multiway speaker binding posts
- Source direct switch
- Loudness control
- Motor-driven volume control
- Audio muting
- Headphone jack

FOR EUROPEAN MODEL

Declaration of Conformity

We, ONKYO EUROPE ELECTRONICS GMBH
INDUSTRIESTRASSE 18/20
82110 GERMERING.
GERMANY



declare in own responsibility, that the ONKYO product described in this instruction manual is in compliance with the corresponding technical standards such as EN55013.EN55020.EN60555-2. EN60065

GERMERING.GERMANY

H. Yamazoe

H. YAMAZOE

ONKYO EUROPE ELECTRONICS GMBH

FOR CANADIAN MODEL: (POUR LE MODELE CANADIEN)

- For models having a power cord with a polarized plug.

CAUTION: TO PREVENT ELECTRIC SHOCK, MATCH WIDE BLADE OF PLUG TO WIDE SLOT. FULLY INSERT.

- Sur les modèles dont la fiche est polarisée.

ATTENTION: POUR ÉVITER LES CHOCS ÉLECTRIQUES, INTRODUIRE LA LAME LA PLUS LARGE DE LA FICHE DANS LA BORNE CORRESPONDANTE DE LA PRISE ET POUSSER JUSQU'AU FOND.

FOR BRITISH MODEL

Replacement and mounting of an AC plug on the power supply cord of this unit should be performed only by qualified service personnel.

IMPORTANT:

The wires in the mains lead are coloured in accordance with the following code:

Blue: Neutral
Brown: Live

As the colours of the wires in the mains lead of this apparatus may not correspond with the coloured markings identifying the terminals in your plug, proceed as follows:

The wire which is coloured BLUE must be connected to the terminal which is marked with the letter N or coloured BLACK.

The wire which is coloured BROWN must be connected to the terminal which is marked with the letter L or coloured RED.

IMPORTANT

A 5 amp fuse is fitted in this plug. Should the fuse need to be replaced please ensure that the replacement fuse has a rating of 5 amps and that it is approved by ASTA or BSI to BS 1362. Check for the ASTA mark or the BSI mark on the body of the fuse.

IF THE FITTED MOULDED PLUG IS UNSUITABLE FOR THE SOCKET OUTLET IN YOUR HOME THEN THE FUSE SHOULD BE REMOVED AND THE PLUG CUT OFF AND DISPOSED OF SAFELY. THERE IS A DANGER OF SEVERE ELECTRICAL SHOCK IF THE CUT OFF PLUG IS INSERTED INTO ANY 13 AMP SOCKET.

If in any doubt please consult a qualified electrician.

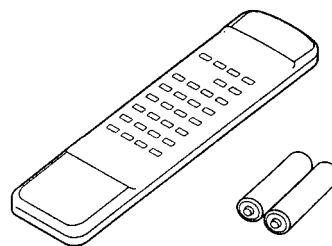

Supplied accessories

Remote control (1)
Batteries (size AA, R6, or UM-3) (2)

WARNING

"TO REDUCE THE RISK OF FIRE OR ELECTRIC SHOCK, DO NOT EXPOSE THIS APPLIANCE TO RAIN OR MOISTURE."

CAUTION:

"TO REDUCE THE RISK OF ELECTRIC SHOCK, DO NOT REMOVE COVER (OR BACK). NO USER-SERVICEABLE PARTS INSIDE. REFER SERVICING TO QUALIFIED SERVICE PERSONNEL."



WARNING

RISK OF ELECTRIC SHOCK
DO NOT OPEN



- The lightning flash with arrowhead symbol, within an equilateral triangle, is intended to alert the user to the presence of uninsulated "dangerous voltage" within the product's enclosure that may be of sufficient magnitude to constitute a risk of electric shock to persons.
- The exclamation point within an equilateral triangle is intended to alert the user to the presence of important operating and maintenance (servicing) instructions in the literature accompanying the appliance.

Important safeguards

1. **Read Instructions** – All the safety and operating instructions should be read before the appliance is operated.
2. **Retain Instructions** – The safety and operating instructions should be retained for future reference.
3. **Heed Warnings** – All warnings on the appliance and in the operating instructions should be adhered to.
4. **Follow Instructions** – All operating and use instructions should be followed.
5. **Water and Moisture** – The appliance should not be used near water – for example, near a bathtub, washbowl, kitchen sink, laundry tub, in a wet basement, or near a swimming pool, and the lake.
6. **Carts and Stands** – The appliance should be used only with a cart or stand that is recommended by the manufacturer.
- 6A. An appliance and cart combination should be moved with care. Quick stops, excessive force, and uneven surfaces may cause the appliance and cart combination to overturn.

7. **Wall or Ceiling Mounting** – The appliance should be mounted to a wall or ceiling only as recommended by the manufacturer.
8. **Ventilation** – The appliance should be situated so that its location or position does not interfere with its proper ventilation. For example, the appliance should not be situated on a bed, sofa, rug, or similar surface that may block the ventilation openings; or if placed in a built-in installation, such as a book case or cabinet that may impede the flow of air through the ventilation openings, there should be free space of at least 20 cm and open up behind the appliance.
9. **Heat** – The appliance should be situated away from heat sources such as radiators, heat registers, stoves, or other appliances (including amplifiers) that produce heat.
10. **Power Sources** – The appliance should be connected to a power supply only of the type described in the operating instructions or as marked on the appliance.
11. **Polarization** – If the appliance is provided with a polarized plug having one blade wider than the other, please read the following information: The polarization of the plug is a safety feature. The polarized plug will only fit the outlet one way. If the plug does not fit fully into the outlet, try reversing it. If there is still trouble inserting it, the user should seek the services of a qualified electrician. Under no circumstances should the user attempt to defeat the polarization of the plug.
12. **Power-Cord Protection** – Power-supply cords should be routed so that they are not likely to be walked on or pinched by items placed upon or against them, especially near plugs, convenience receptacles, and the point where they exit from the appliance.
13. **Cleaning** – The appliance should be cleaned only as recommended by the manufacturer.
14. **Nonuse Periods** – The power cord of the appliance should be unplugged from the outlet when left unused for a long period of time.
15. **Object and Liquid Entry** – Care should be taken so that objects do not fall and liquids are not spilled into the enclosure through openings.
16. **Damage Requiring Service** – The appliance should be serviced by qualified service personnel when:
 - A. The power-supply cord or the plug has been damaged; or
 - B. Objects have fallen, or liquid has been spilled into the appliance; or
 - C. The appliance has been exposed to rain; or
 - D. The appliance does not appear to operate normally or exhibits a marked change in performance; or
 - E. The appliance has been dropped, or the enclosure damaged.
17. **Servicing** – The user should not attempt to service the appliance beyond that described in the operating instructions. All other servicing should be referred to qualified service personnel.

Precautions

1. Warranty Claim

You can find the serial number on the rear panel. In case of warranty claim, please report this number.

2. Recording Copyright

Recording of copyrighted material for other than personal use is illegal without permission of the copyright holder.

3. AC Fuse

The fuse is located inside the chassis and is not user serviceable. If power does not come on, contact your Onkyo authorized service station.

4. Care

From time to time you should wipe the front and rear panels and the cabinet with a soft cloth. For heavier dirt, dampen a soft cloth in a weak solution of mild detergent and water, wring it out dry, and wipe off the dirt. Following this, dry immediately with a clean cloth. Do not use rough material, thinners, alcohol or other chemical solvents or cloths since these could damage the finish or remove the panel lettering.

5. Power

WARNING

BEFORE PLUGGING IN THE UNIT FOR THE FIRST TIME, READ THE FOLLOWING SECTION CAREFULLY.

- The voltage of the available power supply differs according to country or region. Be sure that the power supply voltage of the area where this unit will be used meets the required voltage (e.g., AC230V 50Hz or AC120V 60Hz) written on the rear panel.
- **Models Equipped with a Voltage Selector**
Worldwide models are equipped with a voltage selector to conform to local power supplies. Be sure to set this switch to match the voltage of the power supply in your area before plugging in the unit.

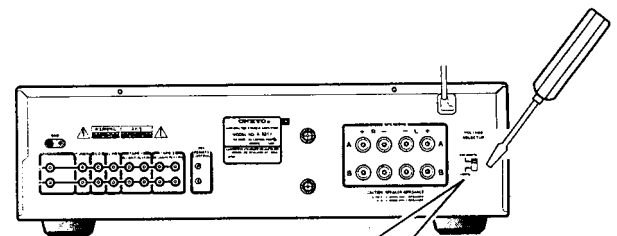

VOLTAGE SELECTOR

220-230V~



120V~

Setting the voltage selector

1. Determine the proper voltage for your area: 220-230V or 120V.
2. If the preset voltage is not correct for your area, insert a screwdriver into the groove in the switch. Slide the switch all the way down (120V) or up (220-230V), whichever is appropriate.

Control positions and names

For more information about buttons or knobs, turn to page number listed in the [].

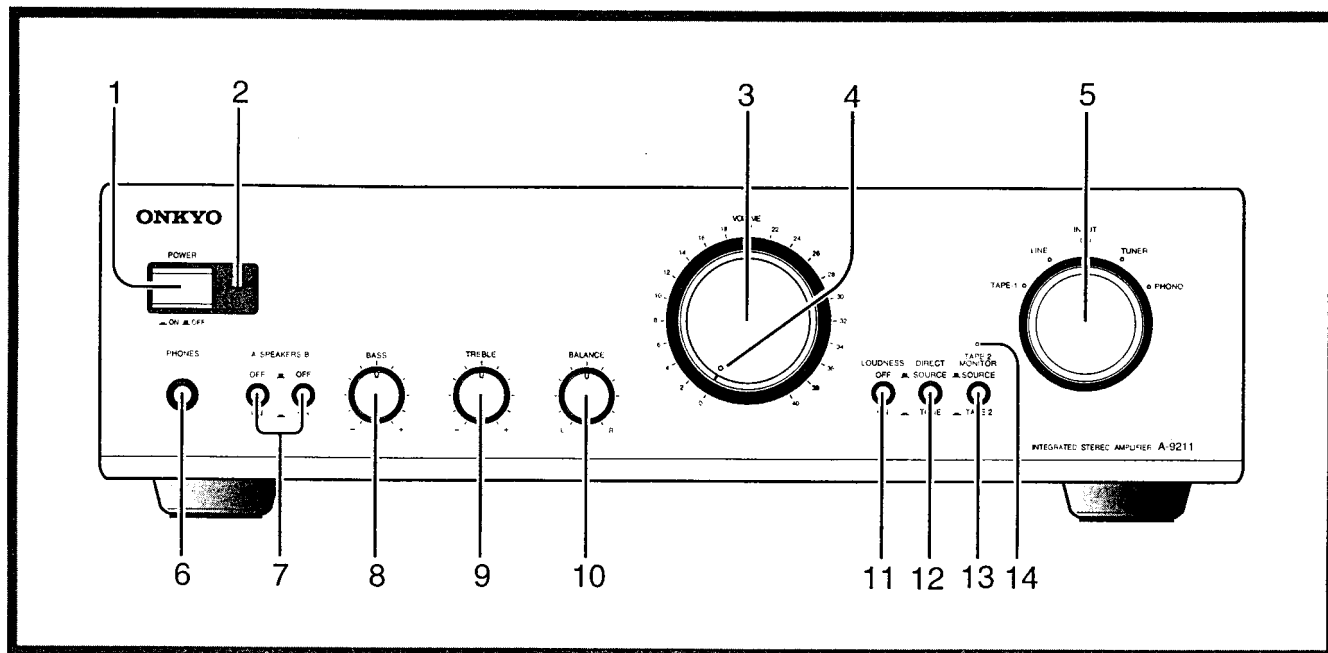

Front panel

1. Power switch [8]
2. Remote control sensor [5]
3. Volume control knob [8]
4. Muting indicator [9]
5. Input selector knob and indicator [8, 10, 11]
6. Headphone jack [8]
7. Speaker selector switches [8]
8. Bass control knob [9]
9. Treble control knob [9]
10. Balance control knob [9]
11. Loudness switch [9]
12. Direct switch [9]
13. Tape-2 Monitor switch [8, 11]
14. Tape-2 Monitor indicator [8]

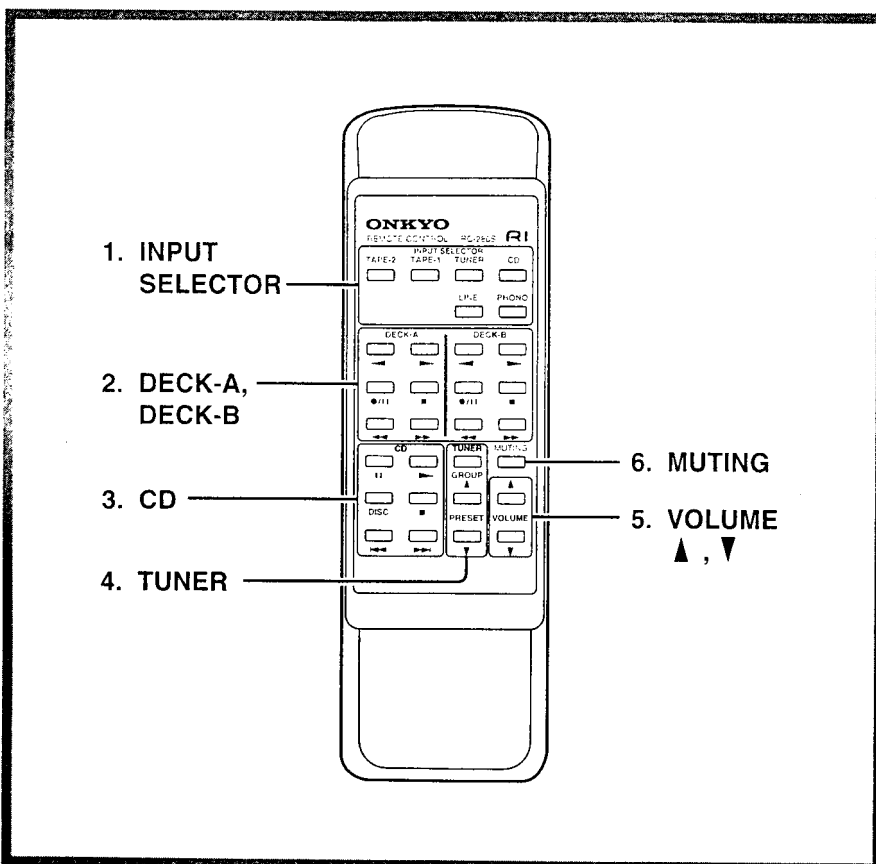

Remote control

1. Input selector buttons
2. Tape operation buttons
 - ◀ : Reverse play button
 - ▶ : Forward play button
 - /|| : Record/pause button
 - : Stop button
 - ◀◀ : Fast rewind button
 - ▶▶ : Fast forward button
3. CD operation buttons
 - || : Pause button
 - ▶ : Play button
 - DISC : Disc button for CD changer
 - : Stop button
 - ◀◀ : Down button
 - ▶▶ : Up button
4. Tuner operation buttons
 - GROUP : Group or class selector button
 - PRESET : Preset memory
 - ▲ (up)/ ▼ (down) buttons
5. Volume control buttons
6. Audio muting button

* In order to use the buttons listed above in 2., 3. and 4., connect the units as shown on page 6-7.

Control positions and names

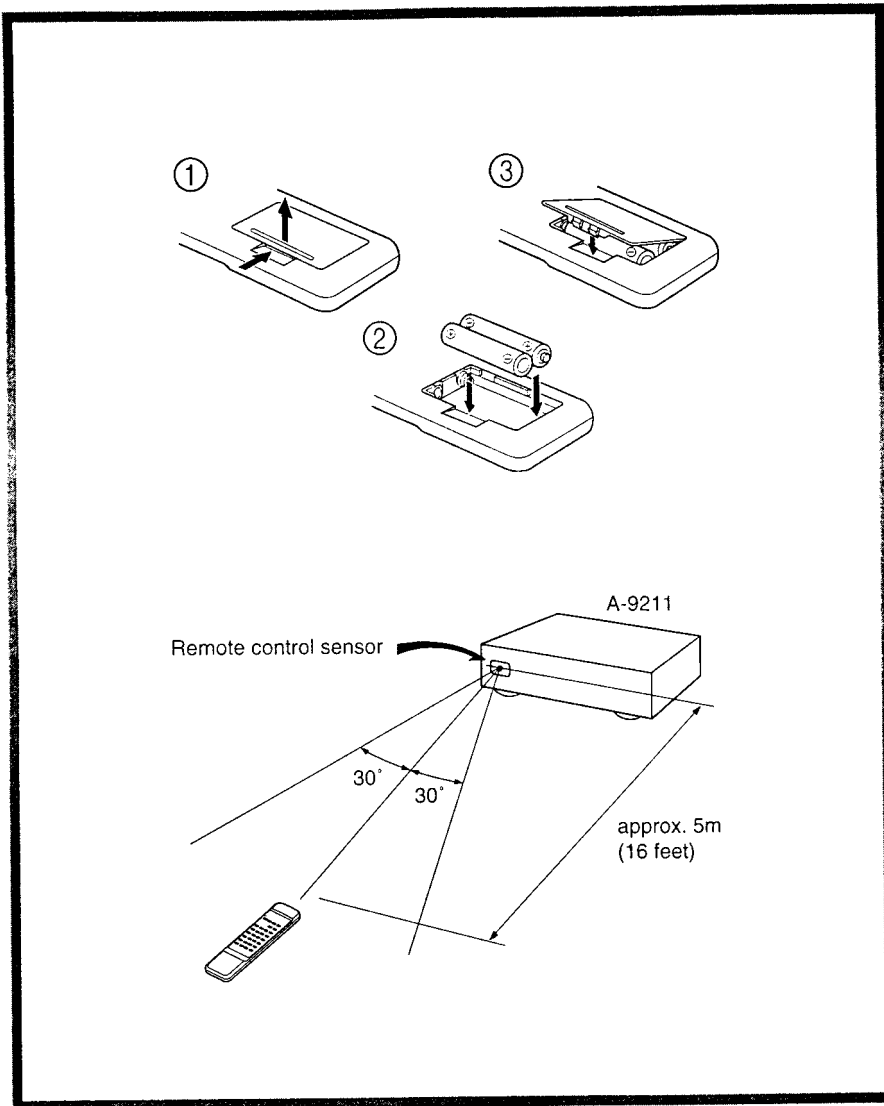

Loading the batteries

Remove the battery compartment cover by opening it as shown in the illustration. Load two R6 (UM-3) AA size batteries into the remote control with the plus (+) and minus (-) terminals positioned as indicated by the diagram inside the battery compartment and close the cover.

- Remove dead batteries immediately to avoid corrosion damage.
- To avoid potential corrosion damage, never mix old batteries with new ones.
- The manganese batteries supplied with this unit have a service life of approximately six months, depending on frequency of usage.
- This unit comes equipped with R6 (UM-3) AA manganese batteries, but we recommend that long-life alkaline batteries LR6 (AM-3) AA be used when replacing the batteries.

Using the remote control

The following information will help you get optimal use from the remote control.

- Place the A-9211 away from direct bright light, which can prevent proper operation of the remote control.
- Make sure audio rack doors do not have colored glass. If the A-9211 is placed behind such a door, this may prevent proper remote control operation.
- Using other remote controls in the same room as the A-9211 remote control may cause interference.

System connections

- Do not plug in the power cord until all connections have been made.
- On each pair of input jacks, the jack (marked R) corresponds to the right channel, and the jack (marked L) to the left channel.
- Please refer to the instruction manual of each component when making any connections.

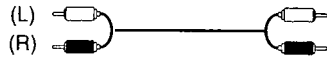

Connecting the speaker cables

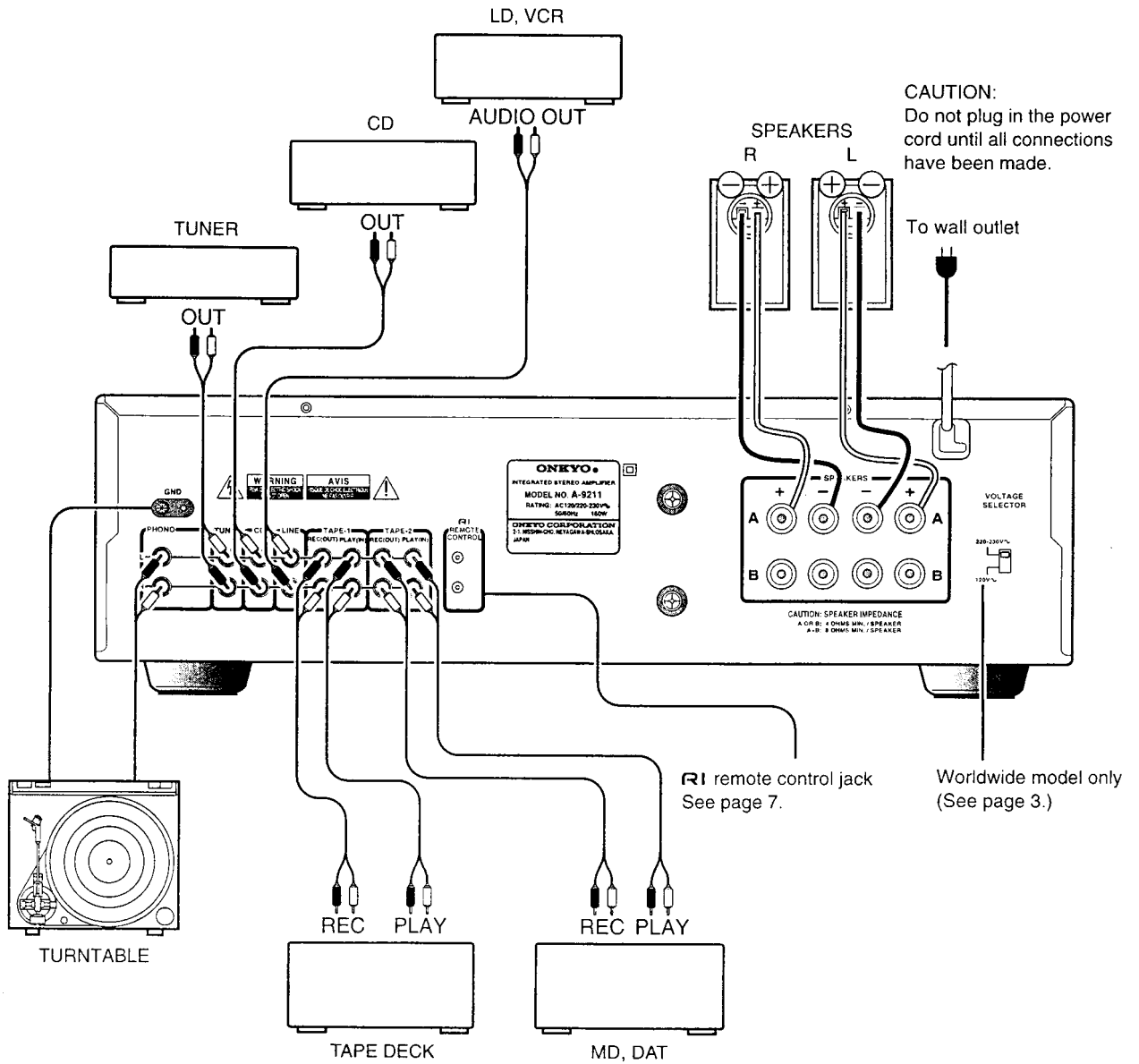
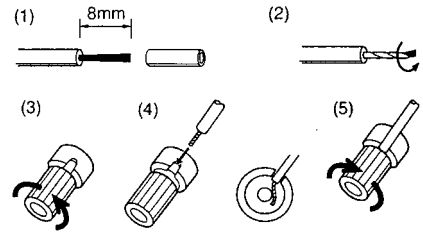

System connections

Connecting a turntable (PHONO)

Connect the output leads of the turntable to the PHONO jacks. Be sure to connect the ground (earth) lead wire from the turntable to the ground terminal (GND). Turntables not provided with GND wires do not need to be connected in this way. Place the turntable on a firm shelf or deck free from vibrations (especially those generated by the speaker system). If the turntable is permitted to pick up such unwanted vibrations, not only will the performance of the unit drop, but distortion in the bass frequencies and howling in the speakers may also occur.

Connecting a CD (CD)

Connect a compact disc player to the CD input jacks.

Connecting a tuner (TUNER)

Connect an FM/AM tuner to the TUNER input jacks.

Connecting additional components (LINE)

This unit is equipped with LINE input jacks for connection to a wide range of audio components such as an additional compact disc player, an additional tuner, a television set, a VCR, a 4-channel stereo adaptor and other similar components.

Connecting a tapedeck (TAPE-1, TAPE-2)

This unit has facilities for two tape decks. If you are using only one tape deck, connect it to the TAPE-1 jacks. If you have two tape decks, connect one to the TAPE-1 jacks and the other to the TAPE-2 jacks.

If you wish to use a graphic equalizer, as well as two tape decks, connect the graphic equalizer to the TAPE-2 jacks, and connect the second tape deck to the TAPE jacks on the graphic equalizer. (See the figure.)

(connect the OUTPUT jacks on the graphic equalizer to the TAPE-2 PLAY jacks on the A-9211, and the INPUT jacks to the TAPE-2 REC jacks as shown.)

Please also see page 11 on how to use a graphic equalizer.

Connecting the speakers

Two separate pairs of speaker systems can be connected to this unit at once.

Please connect each speaker according to the illustration, observing the correct connections for R, L, + and -.

- The load impedance of each speaker system connected to this unit must be at least 4 ohms. (If using only A or only B, 4 ohms min.; if A and B, 8 ohms min.)
- Do not use unnecessarily long or extremely thin speaker leads. If the DC resistance of the speaker leads is too high, the damping factor will decrease, adversely affecting the sound quality.
- When using only one speaker or when you wish to listen to monaural (mono), the single speaker should never be connected in parallel to both the right and left channel terminals at once.

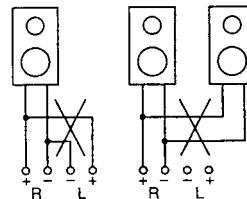

- When using banana plugs, make sure the speaker terminal screws are screwed in firmly before inserting the banana plugs.

Connections for remote control (RI)

A cassette tape deck, compact disc player and tuner that have the Onkyo RI remote control jack can be operated using the A-9211's accessory remote control.

1. To use the A-9211 with an Onkyo cassette tape deck, compact disc player and tuner with the RI remote control jack, connect the components together with RI remote control cables, plugged into the REMOTE CONTROL jacks.
2. As the exact connection sequence of the RI cable is unimportant, you can connect from the A-9211 to either the tuner, the cassette tape deck or to the compact disc player.
3. To operate correctly, the remote control must face towards the remote control sensor of the A-9211.

NOTE:

- The upper and lower RI remote control jacks have the same function.
- A tuner, cassette tape deck, and compact disc player that have the Onkyo RI remote control jack can be operated, using the accessory remote control unit. (RI: Remote Interactive)
- Remote control operation is not possible when only the remote control cable is connected - the audio connection cables must also be connected.
- An RI remote control cable equipped with a 1/8" (3.5mm) diameter miniature two-conductor phone plug is included with every tuner, compact disc player, or cassette tape deck with the RI remote control jack.

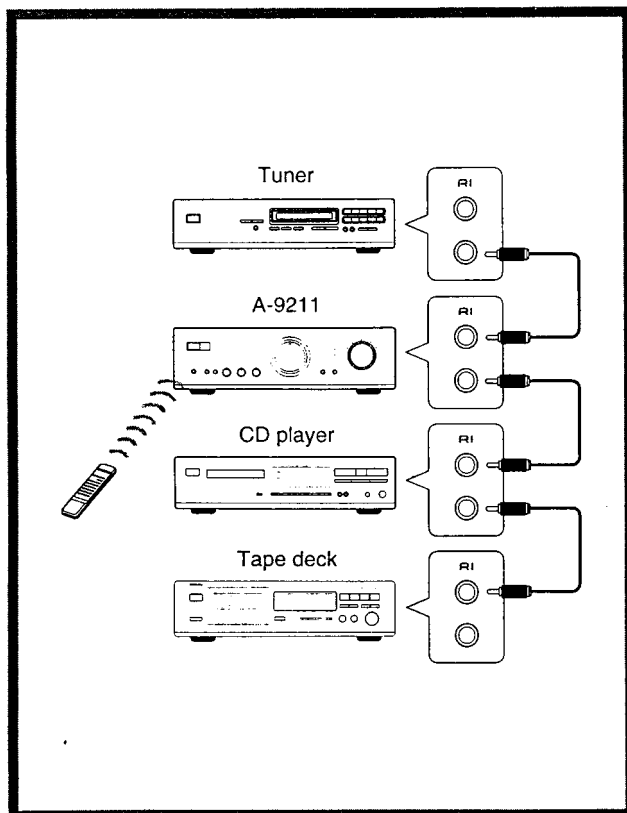

Operations

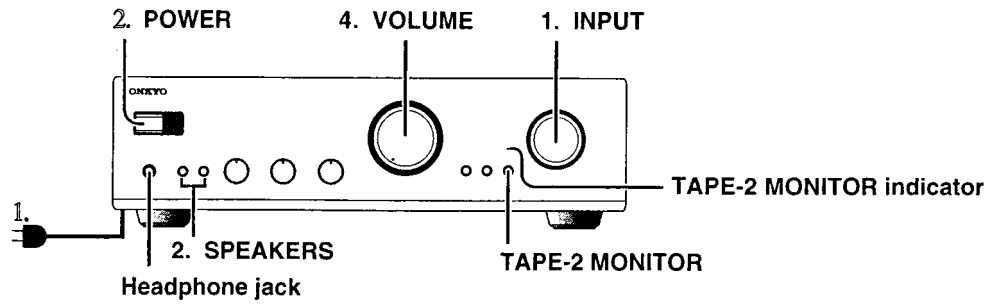

Connecting the power

Before plugging in the unit, confirm that all connections have been made properly.

1. Insert the AC power supply cord into the wall outlet.
2. Press the POWER switch.

Listening to your favorite source

1. Select your favorite source using the input selector (e.g. PHONO).

If you turn the INPUT knob to the right, the indicators will light up one at a time in a clockwise direction. Turning the knob to the left will reverse the direction.

2. Select the speakers.

Select and press the button for the speakers that you want to listen to (SPEAKERS A and/or SPEAKERS B). From now on you will be able to hear from the speakers any sound going through the A-9211. If both SPEAKERS A and B switches are set to OFF, no sound will come from the speakers.

3. Start the selected input source playing. Follow the operating instructions for that unit.

4. Adjust the level.

Turn the VOLUME knob clockwise or press the ▲(up) button on the remote control to increase the volume level. Turn counterclockwise or press the ▼(down) button on the remote control to decrease the volume level.

- Confirm the TAPE-2 MONITOR indicator does not illuminate. If the indicator illuminates, press the TAPE-2 MONITOR switch for SOURCE position.

Listening using the headphones

Stereo headphones with a standard binaural (stereo) plug can be connected here.

When the headphone plug is inserted, the speakers are not automatically muted but can be controlled with the SPEAKERS A/B buttons.

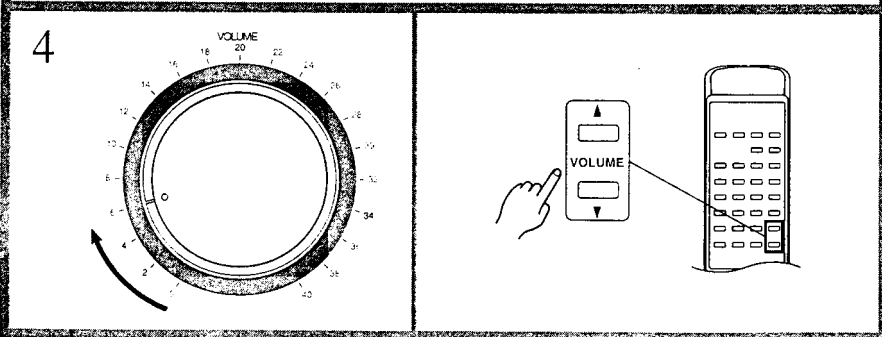
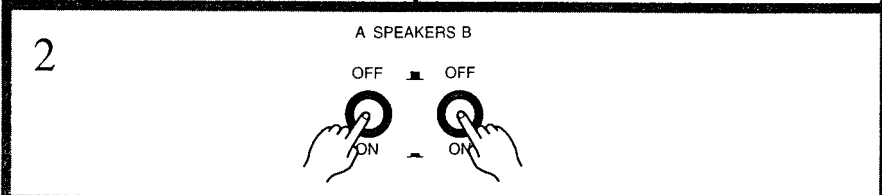
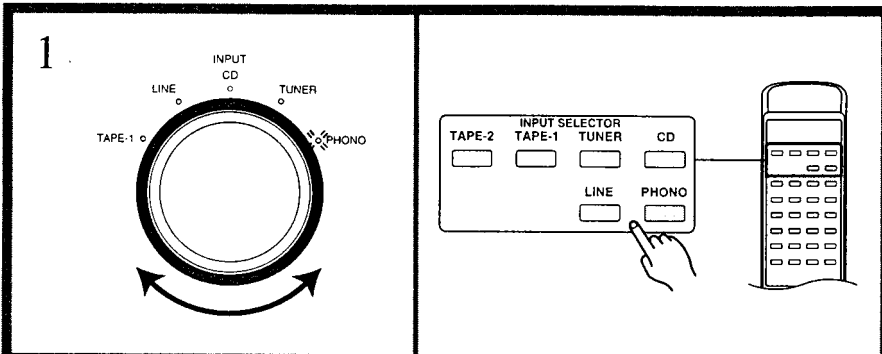
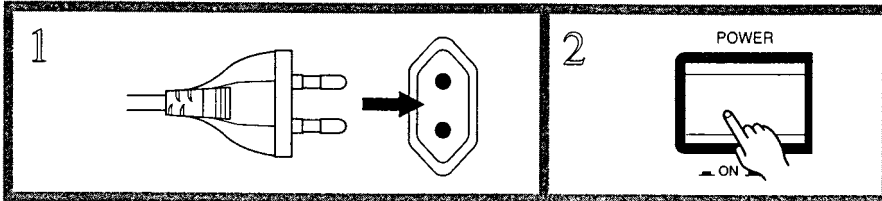

TAPE-2 MONITOR button

When operating the unit connected to tape-2, the TAPE-2 MONITOR switch must be turned on for TAPE-2 position. The TAPE-2 MONITOR indicator illuminates, indicating the monitoring state.

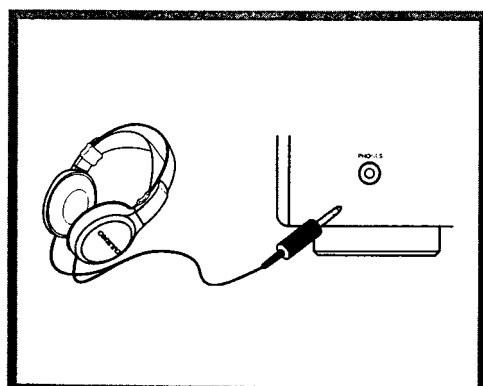

Operations

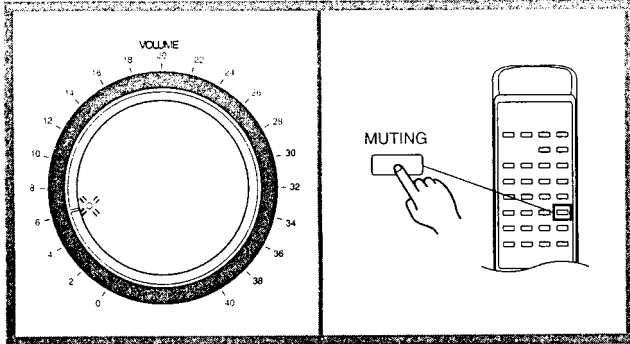
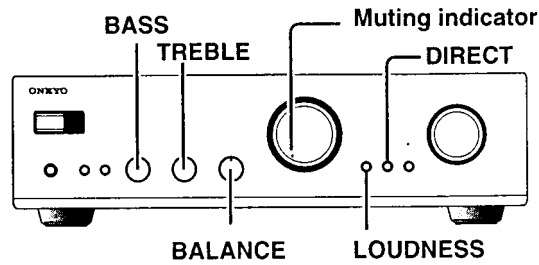

Temporary Muting (Only for the remote control)

Press the **MUTING** button on the remote control.

This button temporarily switches off the sound from the speakers or headphones. The **MUTING** indicator blinks.

To cancel,

- press the **MUTING** button again, *or*
- adjust the volume with the remote controller, *or*
- turn the power off, then on.

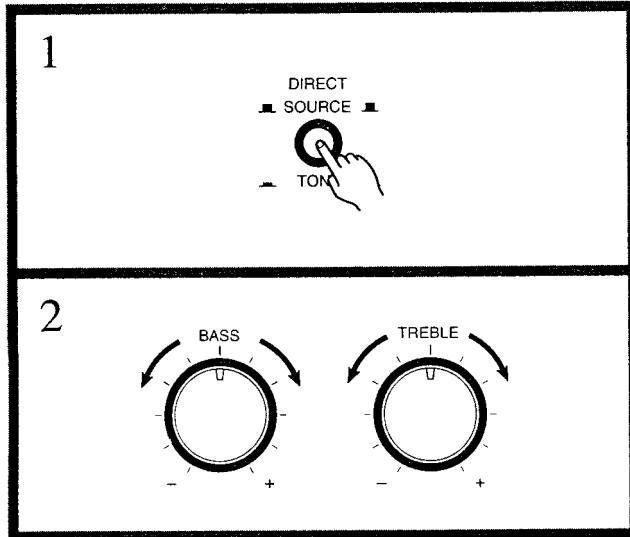

Adjusting the tone

1. Turn the **DIRECT** switch to the **TONE** position (—).
2. Adjust to your desired tone.

BASS : Turn this knob clockwise to boost or counterclockwise to attenuate the bass. When this knob is in the center position, the frequency response of the bass tone control is flat, i.e. the bass is neither boosted nor attenuated.

TREBLE: Turn this knob clockwise to boost or counterclockwise to attenuate the treble. When this knob is in the center position, the frequency response of treble tone control is flat, i.e. the treble is neither boosted nor attenuated.

When turned to the extreme left, the treble control acts as a high cut filter to eliminate scratches, hissing and other high frequency noise.

NOTE:

When the **DIRECT** switch is set to **DIRECT**, the bass and treble can not be adjusted.

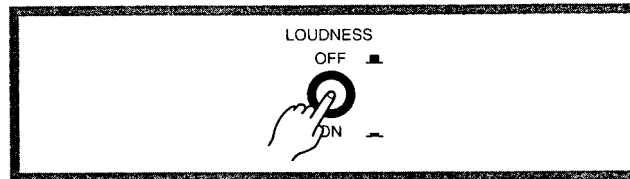

LOUDNESS control

By pressing the **LOUDNESS** button, both treble and bass are reinforced even when the volume is turned down low. Use this button according to the music source and according to the listening area. Its purpose is to enrich the natural sound effects of both the treble and bass.

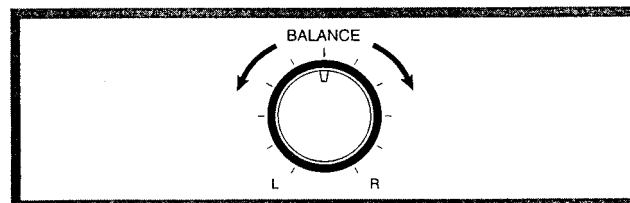

Adjusting the balance

The **BALANCE** knob is used to control the relative volume level of the left and right speaker systems or headphones.

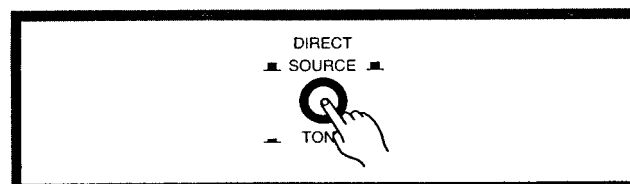

SOURCE DIRECT

By selecting **DIRECT**, you can obtain the purest possible sound reproduction, by bypassing the bass and treble controls. It is still possible to adjust the volume.

Recording

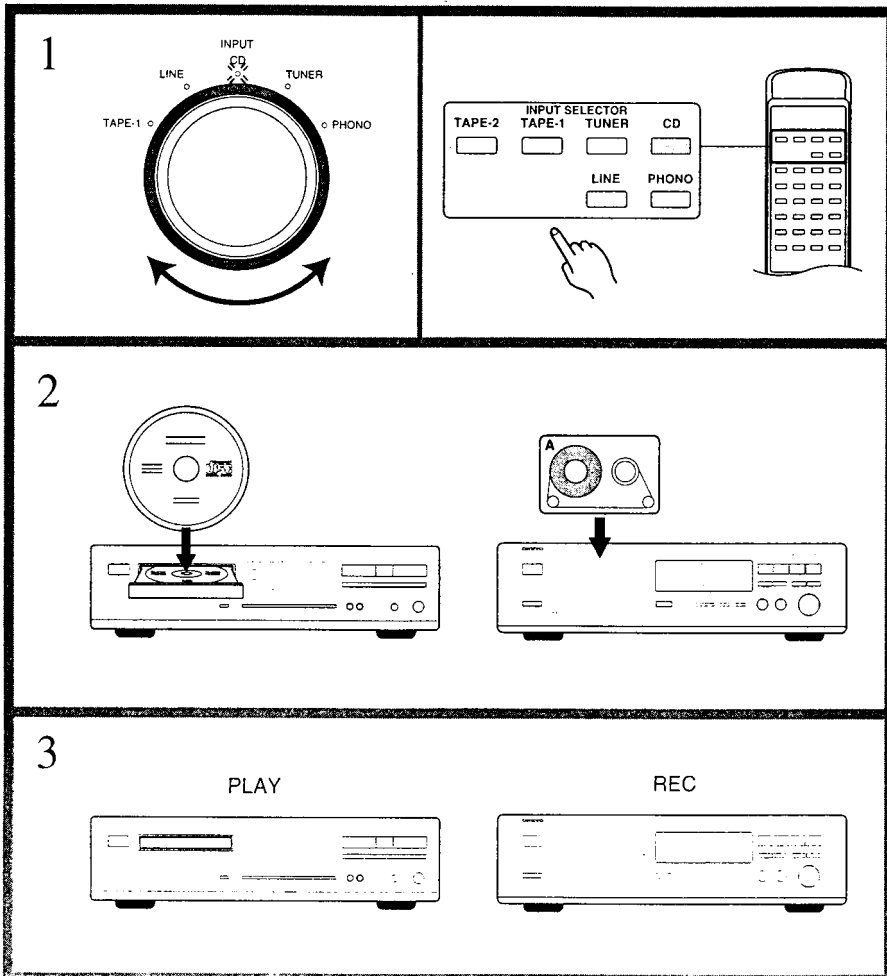
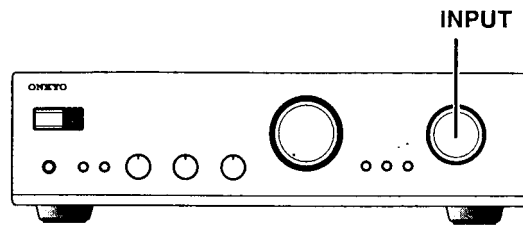

Recording

When recording the same source being listened to (e.g. when recording on TAPE-1 and/or TAPE-2 from a CD):

1. **Select CD with the input selector.**
If you turn the INPUT knob clockwise, the indicators will light up one at a time in a clockwise direction. Turning the knob counterclockwise will reverse the direction.
2. **Insert the CD that you want to record into the CD player. Insert into the tape deck(s) connected to TAPE-1 and/or TAPE-2 a blank tape to record onto.**
3. **Press the record button on the tape deck, then the play button on the CD player.**
 - When TAPE-1 is selected with the INPUT knob, it will record to the TAPE-2 REC jacks.
 - You are able to record the source selected with the INPUT knob onto TAPE-2 whether the TAPE-2 MONITOR switch is turned on or off.
 - When either PHONO, TUNER, CD or LINE is selected, you are able to record to both the TAPE-1 and TAPE-2 REC jacks.

NOTE:

Do not change the INPUT knob while recording.

Tape dubbing

Using two tape decks to copy one tape to another tape is called tape dubbing.

- Select the TAPE-1 on the INPUT knob.
- If a 3-headed deck is used and the TAPE-2 MONITOR switch is turned on, you will be able to listen to (monitor) the sound being recorded.

NOTE:

- You are only able to dub from TAPE-1 to TAPE-2.
- Do not change the INPUT knob while dubbing.

Connecting a graphic equalizer

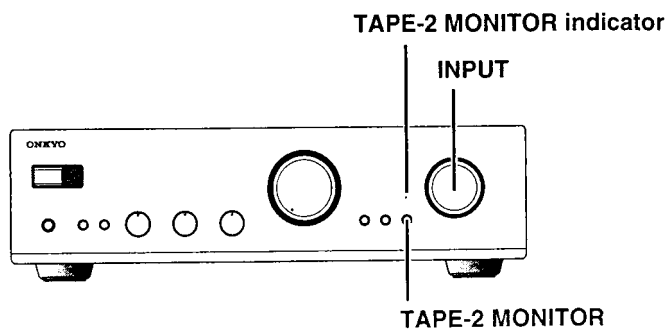

Graphic equalizer

When connecting the A-9211 to a graphic equalizer, connect the graphic equalizer's input jacks to the A-9211's TAPE-2 REC jacks. Also, connect the graphic equalizer's output terminals to the A-9211's TAPE-2 PLAY jacks.

1. Press the TAPE-2 MONITOR switch to the TAPE-2 position, and TAPE-2 MONITOR indicator will illuminate.
2. Select CD, TUNER, LINE, TAPE-1 or PHONO (whichever one you want to listen to) on the INPUT knob.
3. Operate the graphic equalizer.
4. Begin playing.
 - Depending on the particular graphic equalizer used, it may provide features such as muting and balance, as well as tone control (equalization).
 - For the equalization of a source other than a CD, tuner, or phono, connect the source device to the amplifier's CD, TUNER, or LINE input jacks. (If the device is connected to a jack other than the CD, TUNER, LINE or PHONO input jacks, equalization is not possible.)

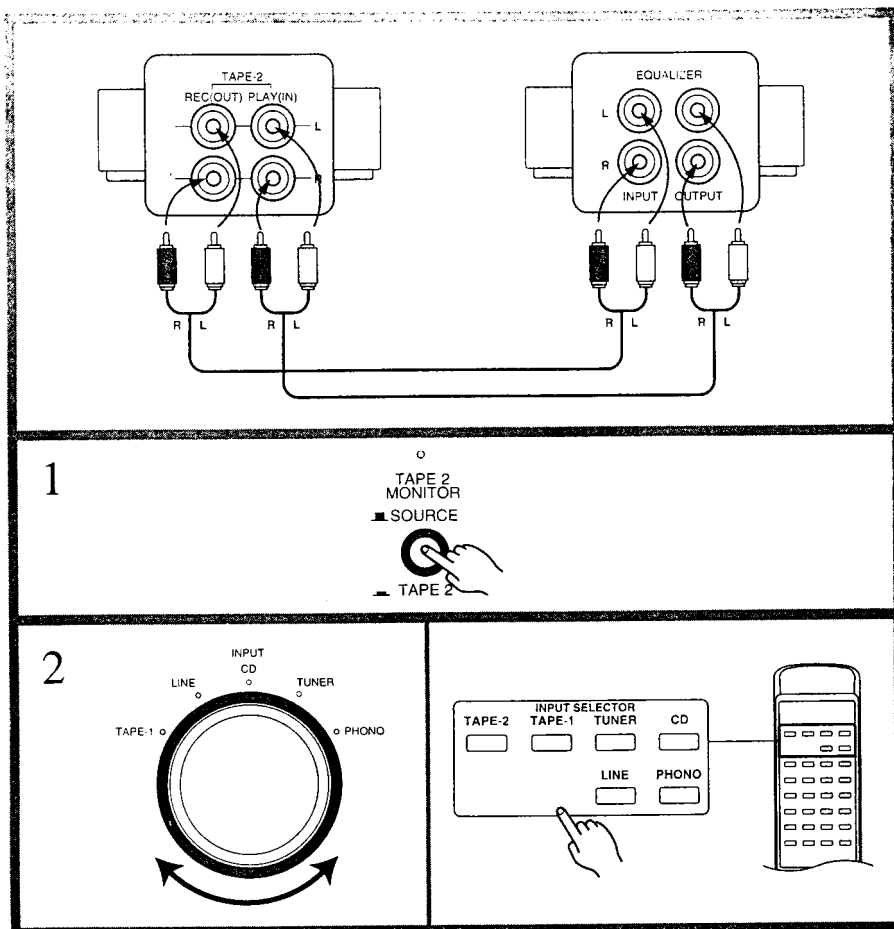

Troubleshooting guide

- **No power.**
Cause: The power cord is not plugged in.
Remedy: Plug in the power cord.
Cause: AC fuse blown.
Remedy: Contact Onkyo Service Center.
- **Power but no sound.**
Cause: Bad connections.
Remedy: Check input leads, pin plugs, etc.
- **Hum, low frequency noise.**
Cause: Poor or no input ground.
Remedy: Check outer conductor of input plugs.
Cause: Poor or no phono motor ground.
Remedy: Check for proper ground connection.
- **Howling when the volume is turned up.**
Cause: Turntable and speakers are too close together.
Remedy: Move them farther apart.
- **Rough or scratchy sound. High range is not clear.**
Cause: Stylus of pick-up is worn.
Remedy: Replace.
Cause: Stylus is dirty.
Remedy: Clean.
Cause: Treble control is too high.
Remedy: Turn treble control down.
- **Front panel controls function but remote control does not.**
Cause: No batteries in remote control.
Remedy: Insert batteries.
Cause: Batteries have worn out.
Remedy: Replace batteries.

Specifications

Power output:	40 watts per channel, min RMS, at 8 ohms, both channels driven from 20 Hz to 20 kHz, with no more than 0.08% THD. 2 × 60 watts at 4 ohms, 1 kHz (DIN) 2 × 45 watts at 8 ohms, 1 kHz (DIN)
Total Harmonic Distortion:	0.08% at rated power
IM Distortion:	0.1% at rated power
Damping Factor:	60 at 8 ohms
Frequency response:	15 Hz—50 kHz ±1 dB
Input sensitivity/impedance	
Phono:	2.5 mV/50 kohms
Tuner/CD/Line:	150 mV/25 kohms
Tape Play:	150 mV/25 kohms
Output sensitivity/impedance	
Tape Rec:	150 mV/25 kohms (phono)
Phono overload:	130 mV RMS at 1 kHz, 0.1% THD (REC)
Bass control:	±8 dB at 100 Hz
Treble control:	±8 dB at 10 kHz
Loudness control:	+8 dB at 100 Hz +2 dB at 10 kHz
Signal to noise ratio (IHF-A)	
Phono:	80 dB (5 mV input)
Direct:	102 dB (0.5 V input) (CD)
Muting:	-50 dB

General

Power supply:	AC 230 V, 50 Hz AC 120 V and 220-230 V switchable, 50 Hz/60 Hz
Dimensions:	435 (W) × 120 (H) × 331 (D) mm 17-1/8" × 4-3/4" × 13-1/16"
Weight:	6.7 kg, 14.8 lbs.

Remote control RC-286S

Transmitter:	Infrared
Signal range:	Approx. 5 meters, 16ft
Power supply:	Two "AA" batteries (1.5 V × 2)
Dimensions:	55 (W) × 18 (H) × 194 (D) mm 2-3/16" × 11/16" × 7-5/8"
Weight:	100 grams, 3.5 oz. (including batteries)

Specifications and features are subject to change without notice.

ONKYO CORPORATION

Sales & Product Planning Div. : 2-1, Nisshin-cho, Neyagawa-shi, OSAKA 572, JAPAN
Tel: 0720-31-8111 Fax: 0720-33-5222

ONKYO U.S.A. CORPORATION

200 Williams Drive, Ramsey, N.J. 07446, U.S.A.
Tel: 201-825-7950 Fax: 201-825-8150 E-mail: onkyo@onkyousa.com

ONKYO EUROPE ELECTRONICS GmbH

Industriestrasse 18-20, 82110 Germering, GERMANY
Tel: 089 84 93 20 Fax: 089 84 93 226

ONKYO FRANCE

Immeuble Le Diamant, Domaine Technologique de Saclay, 4 Rue René Razel,
91892 SACLAY, FRANCE Tel: (1) 69 33 14 00 Fax: (1) 69 41 35 84