

COMPACT  
**disc**  
DIGITAL AUDIO

*Artistry in Sound*  
**ONKYO**<sup>®</sup>

# ***DX-708/706***

**Compact Disc Player**

**Instruction Manual**

• *Congratulations on your purchase of the ONKYO DX-708/706 CD Player.* • *Please read this manual thoroughly before making connections and turning power on.* • *Following the instructions in this manual will enable you to obtain optimum performance and listening enjoyment from your new DX-708/706.* • *Please retain this manual for future reference.*

## CONTENTS

Features .....	1
Important safeguards .....	2
Precautions .....	3
Before using this unit .....	3
System connections .....	4
Control positions and names .....	5
Handling compact discs .....	6
Common modes of operation .....	7
Using the Memory function .....	9
Functions which can be operated only by using the remote control transmitter .....	11
Using the remote control transmitter .....	13
Troubleshooting guide .....	14
Specifications .....	14

### Features

- **ONKYO Single-Bit D/A Converters**

Instead of the "multi-bit" D/A converters employed in many CD players, the DX-708 and DX-706 use an innovative "single-bit" system. It does away with the ladder network required by conventional "high-bit" converters and, therefore, needs none of the delicate "trimming" which such networks require to achieve even adequate linearity. The operating principle of the single bit system assures far better linearity than conventional D/A converters can ever achieve.

- **Zero Shift Noise Shaper**

The noise attenuation characteristics produced by the digital feedback configurations used in conventional noise shapers are marked by a continuous reduction from the high frequency range down through the low frequencies. In contrast to this, ONKYO's new Zero Shift Noise Shaper employs a different feedback factor to produce not a continuous slope, but an attenuation pattern in which noise is reduced to zero in the middle of the frequency range.

The practical effect of this modification is a measurable reduction in residual noise in the audio frequency range, compared with conventional designs. The resulting improvement in the CD player's S/N ratio means more dynamic music reproduction, allowing the listener to hear delicate nuances which might have been missed otherwise. ONKYO's Zero Shift Noise Shaper heightens the small signal fidelity of the single-bit D/A conversion process for improved musicality with any program source.

- **Complementary Distortion Canceler**

- **AccuPulse Quartz System**

- **Center Mounted Disc Tray**

In the DX-708 and DX-706, the central location of the disc drive mechanism serves to divide the digital and analog circuit blocks into two discrete sections. The DX-708 is even equipped with separate power supplies for the two sections, offering further protection against mutual interference. This arrangement helps to prevent DSI (Digital Signal Interference) from leaking into the analog stage and also contributes to improved stability for the chassis as whole.

- **Dual AEI Power Transformers (DX-708)**

- **Newly Developed Linear Motor Actuator for Faster Access and Better Pickup Precision**

- **Diecast Aluminum Disc Tray**

- **Opto-Coupling (DX-708)**

- **Eight-Times Oversampling Digital Filter**

- **Peak Search Function Facilitates Making Recordings to Cassette Tape.**

- **Optical Digital Output**

- **Front Panel Dimmer Switch**

- **RI Compatible Remote Control Included**

- **Copper Plated Chassis (DX-708)**

### CAUTION

"TO REDUCE THE RISK OF ELECTRIC SHOCK, DO NOT REMOVE COVER (OR BACK). NO USER-SERVICEABLE PARTS INSIDE. REFER SERVICING TO QUALIFIED SERVICE PERSONNEL."



**CAUTION**  
RISK OF ELECTRIC SHOCK  
DO NOT OPEN



- The lightning flash with arrowhead symbol, within an equilateral triangle, is intended to alert the user to the presence of uninsulated "dangerous voltage" within the product's enclosure that may be of sufficient magnitude to constitute a risk of electric shock to persons.



- The exclamation point within an equilateral triangle is intended to alert the user to the presence of important operating and maintenance (servicing) instructions in the literature accompanying the appliance.

### "WARNING"

"TO REDUCE THE RISK OF FIRE OR ELECTRIC SHOCK, DO NOT EXPOSE THIS APPLIANCE TO RAIN OR MOISTURE."

- For models having power cords with a polarized plug.

**CAUTION:** TO PREVENT ELECTRIC SHOCK DO NOT USE THIS (POLARIZED) PLUG WITH AN EXTENSION CORD, RECEPTACLE OR OTHER OUTLET UNLESS THE BLADES CAN BE FULLY INSERTED TO PREVENT BLADE EXPOSURE.

- Sur les modèles dont la fiche est polarisée.

**ATTENTION:** POUR PRÉVENIR LES CHOCS ÉLECTRIQUES NE PAS UTILISER CETTE FICHE POLARISÉE AVEC UN PROLONGATEUR, UNE PRISE DE COURANT OU UNE AUTRE SORTIE DE COURANT, SAUF SI LES LAMES PEUVENT ÊTRE INSÉRÉES À FOND SANS EN LAISSER AUCUNE PARTIE À DÉCOUVERT.

## Important safeguards

1. **Read Instructions** – All the safety and operating instructions should be read before the appliance is operated.
  2. **Retain Instructions** – The safety and operating instructions should be retained for future reference.
  3. **Heed Warnings** – All warnings on the appliance and in the operating instructions should be adhered to.
  4. **Follow Instructions** – All operating and user instructions should be followed.
  5. **Water and Moisture** – The appliance should not be used near water – for example, near a bathtub, washbowl, kitchen sink, laundry tub, in a wet basement, or near a swimming pool, and the like.
  6. **Carts and Stands** – The appliance should be used only with a cart or stand that is recommended by the manufacturer.
- 6A. An appliance and cart combination should be moved with care. Quick stops, excessive force, and uneven surfaces may cause the appliance and cart combination to overturn.
- PORTABLE CART WARNING**



S3175A
7. **Wall or Ceiling Mounting** – The appliance should be mounted to a wall or ceiling only as recommended by the manufacturer.
  8. **Ventilation** – The appliance should be situated so that its location or position does not interfere with its proper ventilation. For example, the appliance should not be situated on a bed, sofa, rug, or similar surface that may block the ventilation openings; or, placed in a built-in installation, such as a bookcase or cabinet that may impede the flow of air through the ventilation openings.
  9. **Heat** – The appliance should be situated away from heat sources such as radiators, heat registers, stoves, or other appliances (including amplifiers) that produce heat.
  10. **Power Sources** – The appliance should be connected to a power supply only of the type described in the operating instructions or as marked on the appliance.
  11. **Polarization** – If the appliance is provided a polarized plug having on blade wider than the other, please read the following information; The polarization of the plug is a safety feature. The polarized plug will only fit the outlet one way. If the plug does not fit fully into the outlet, try reversing it. If there is still trouble, the user should seek the services of a qualified electrician. Under no circumstances should the user attempt to defeat the polarization of the plug.
  12. **Power-Cord Protection** – Power-supply cords should be routed so that they are not likely to be walked on or pinched by items placed upon or against them, paying particular attention to cords at plugs, convenience receptacles, and the point where they exit from the appliance.
  13. **Cleaning** – The appliance should be cleaned only as recommended by the manufacturer.
  14. **Nonuse Periods** – The power cord of the appliance should be unplugged from the outlet when left unused for a long period of time.
  15. **Object and Liquid Entry** – Care should be taken so that objects do not fall and liquids are not spilled into the enclosure through openings.
  16. **Damage Requiring Service** – The appliance should be serviced by qualified service personnel when:
    - A. The power-supply cord or the plug has been damaged; or
    - B. Objects have fallen, or liquid has been spilled into the appliance; or
    - C. The appliance has been exposed to rain; or
    - D. The appliance does not appear to operate normally or exhibits a marked change in performance; or
    - E. The appliance has been dropped or the enclosure damaged.
  17. **Service** – The user should not attempt to service the appliance beyond that described in the operating instructions. All other servicing should be referred to qualified service personnel.

## SPECIAL CAUTIONS FOR COMPACT DISC PLAYER

- This Compact Disc Player contains a semiconductor laser system and is classified as a "CLASS 1 LASER PRODUCT". So, to use this model properly, read this Owner's Manual carefully. In case of any trouble, please contact the store where you purchased the unit. To prevent being exposed to the laser beam, do not try to open the enclosure.
- The laser is covered by a housing which prevents exposure during operation or maintenance. However, this product is classified as a Laser Product by CDRH (Center for Devices and Radiological Health) which is a department of the Food and Drug Administration. According to their regulations 21 CFR section 1002.30, all manufacturers who sell Laser Products must maintain records of written communications between the manufacturer, dealers and customers concerning radiation safety. If you have any complaints about instructions or explanations affecting the use of this product, please feel free to write to the address on the back page of this manual. When you write us, please include the model number and serial number of your Compact Disc Player.
- In compliance with Federal Regulations, the certification, identification and the period of manufacture are indicated on the rear panel.
- **DANGER:**  
INVISIBLE LASER RADIATION WHEN OPEN AND INTERLOCK FAILED OR DEFEATED. AVOID DIRECT EXPOSURE TO BEAM.
- **CAUTION:**  
THIS PRODUCT UTILIZES A LASER. USE OF CONTROLS OR ADJUSTMENTS OR PERFORMANCE OF PROCEDURES OTHER THAN THOSE SPECIFIED HEREIN MAY RESULT IN HAZARDOUS RADIATION EXPOSURE.
- **Notice Concerning FCC Regulations**  
This equipment generates and uses radio frequency energy and, if not installed and used properly, that is, in strict accordance with the manufacturer's instructions, may cause interference to radio and television reception. It has been type tested and found to comply with the limits for a Class B computing device in accordance with the specifications in Subpart J of Part 15 of FCC Rules, which are designed to provide reasonable protection against such interference in a residential installation. However, there is no guarantee that interference will not occur in a particular installation. If this equipment does cause interference to radio and television reception, which can be determined by turning the equipment off and on, the user is encouraged to try to correct the interference by one or more of the following measures:
  - Reorient the receiving antenna.
  - Relocate the unit with respect to the receiver. Move the unit away from the receiver. Plug the unit into a different outlet so that the unit and receiver are on different branch circuits.If necessary, the user should consult the dealer or an experienced radio/television technician for additional suggestions. The user may find the following booklet prepared by the Federal Communications Commission helpful: "How to identify and Resolve Radio-TV interference problems."  
This booklet is available from the U.S. Government Printing Office, Washington, D.C. 20402, Stock No. 004-000-00345-4.
- THIS DIGITAL APPARATUS DOES NOT EXCEED THE CLASS B LIMITS FOR RADIO NOISE EMISSION FROM DIGITAL APPARATUS SET OUT IN THE RADIO INTERFERENCE REGULATIONS OF THE CANADIAN DEPARTMENT OF COMMUNICATIONS.
- L'INTERFERENCE, RADIOELECTRIQUE GENEREE PAR CET APPAREIL NUMERIQUE DE TYPE B NE DEPASSE PAS LES LIMITES ENONCEES DANS LE REGLEMENT SUL LES PERTURBATIONS RADIOELECTRIQUES, SECTION APPAREIL NUMERIQUE, DU MINISTERE DES COMMUNICATIONS.

## Precautions

### 1. Warranty Card

The serial number is written on the rear panel of this unit. Copy the serial number and model number onto your warranty card and keep it in a safe place.

### 2. Do Not Touch the Player with Wet Hands

Do not handle the player or power cord when your hands are wet or damp. If water or any other liquid enters the player cabinet, take the player to an authorized service station for inspection.

### 3. Location of the Player

- Place the Player in a Well-Ventilated Location.  
Take special care to provide plenty of ventilation on all sides of the player especially when it is placed in an audio rack. If ventilation is blocked, the player may overheat and malfunction.
- Do not expose the player to direct sunlight or heating units as the player's internal temperature may rise and shorten the life of the pickup.
- Avoid damp and dusty places and places directly affected by vibrations from the speakers. In particular, avoid placing the unit on or above one of the speakers.
- Be sure the player is placed in a horizontal position. Never place it on its side or on a slanted surface as it may malfunction.
- Do Not Place Near Tuners and TV Sets.  
If placed next to a TV or other tuner, it may cause reception interference resulting in some noise in the TV or tuner output.

### 4. Care

From time to time you should wipe off the front and rear panels and the cabinet with a silicon or other soft cloth. For heavier dirt, dampen a soft cloth in a weak solution of mild detergent and water, wring it out dry, and wipe away the dirt. Following this, dry immediately with a clean cloth. Do not use rough material, thinners, alcohol or other chemical solvents or cloths since these may damage the finish or remove the panel lettering.

### 5. Points to Remember

- If the player is brought from a cold environment to a warm one or is in a cold room that is quickly heated, dew may form on the pickup, preventing proper operation. In this case, remove the disc and leave the power ON for about one hour to remove the dew.
- Always close the disc tray when not loading or unloading discs to protect delicate internal parts from dust.
- When transporting the player, be careful not to bump it.

## Before using this unit

### How to Release the Transport Lock

To protect the optical assembly including the laser pickup from vibration related damage during shipping, this unit is equipped with a transport lock lever located on the base.

1. Loosen the screw with a Phillips screwdriver.
  2. Move the lock lever in the opposite direction to that shown by the arrow. Move the lever up to the position where it can move no farther.
  3. Then re-tighten the screw into lock lever screw hole.
- Tighten the screw to secure the lock lever.
    - For shipping, turn the lock lever to its position in the direction of the arrow, then tighten down the screw to secure the lock lever in that position.

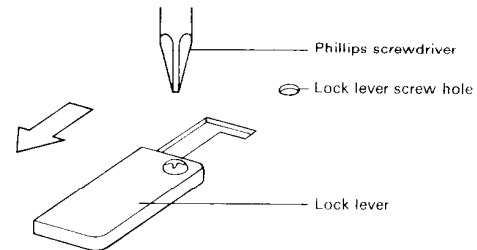

## Supplied accessories

Output signal cord × 1



RI remote control cable × 1



Remote control transmitter  
RC-217C (DX-706) × 1  
RC-218C (DX-708) × 1  
Battery × 2

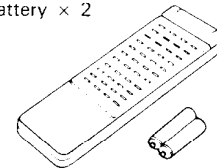

## System connections

- Do not plug in the power cord until all connections have been made.
- This unit has two sets of analog OUTPUT jacks and a DIGITAL OUTPUT jack.

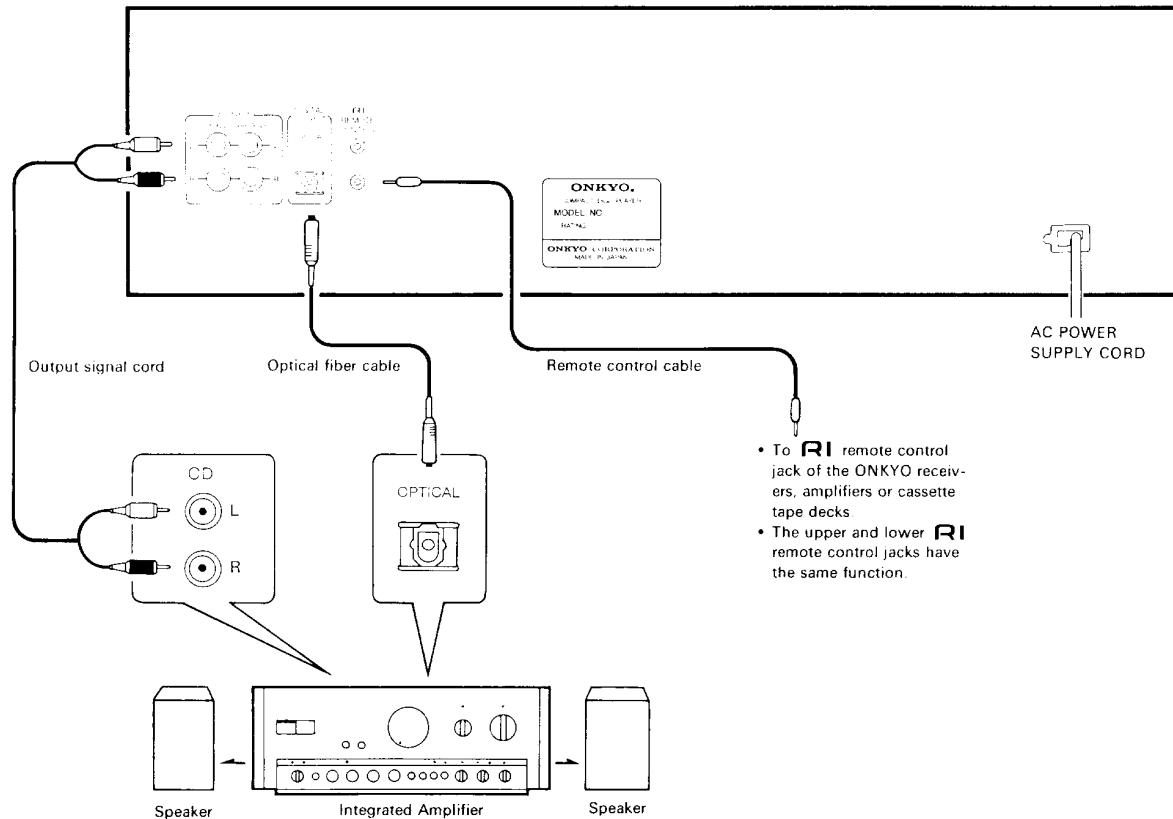

### Connecting to the analog OUTPUT jacks

- Connect the OUTPUT jacks of this unit to the AUX or CD input jacks of an amplifier. When making connections, be sure that the left and right channel connections are not crossed.
- This unit is equipped with two OUTPUT jacks, FIXED and VARIABLE. Use the one that matches your purpose.

### Connecting digital signals (DIGITAL OUTPUT)

- This unit has a digital audio interface format digital jacks for optical output.

#### NOTE:

The optical digital output jack has a protective cap. Remove this cap before using this jack. When not using this jack, always put this protective cap back on the jack.

### Remote Control jacks

The remote control jacks are used to connect ONKYO products bearing the "RI" mark via the accessory remote control cable. The cassette deck with the "RI" mark can be operated using the RC-217C/218C remote control transmitter provided as an accessory with the DX-706/708. When this unit is connected with ONKYO receivers or amplifiers bearing the "RI" mark, it can also be controlled by the remote control transmitter of that unit. (Refer to the operating instructions of your stereo receiver or amplifier for details.)

#### NOTE:

Do not connect the **RI** remote control jack to any unit that does not bear the ONKYO "RI" mark. Doing so may damage the unit.

## Using the timer during performance

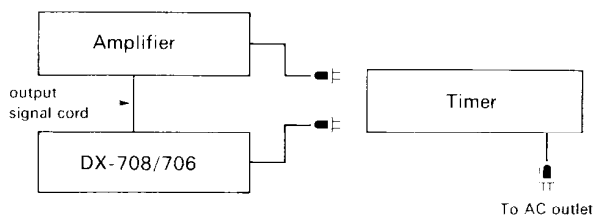

If you have an audio timer, it can be used to start a performance at any time you desire.

- ① Turn on the DX-708/706 and the amp which is connected to the DX-708/706.
- ② Insert a compact disc into the DX-708/706 disc tray.
- ③ Set the time on the timer.
  - For more details, please consult the section which explains the operations of the timer.
  - When the time specified arrives, the CD player's auto-play function will begin the performance automatically.

# Control positions and names

## Front panel

For more information about buttons or controls, turn to the page number listed in the [ ].

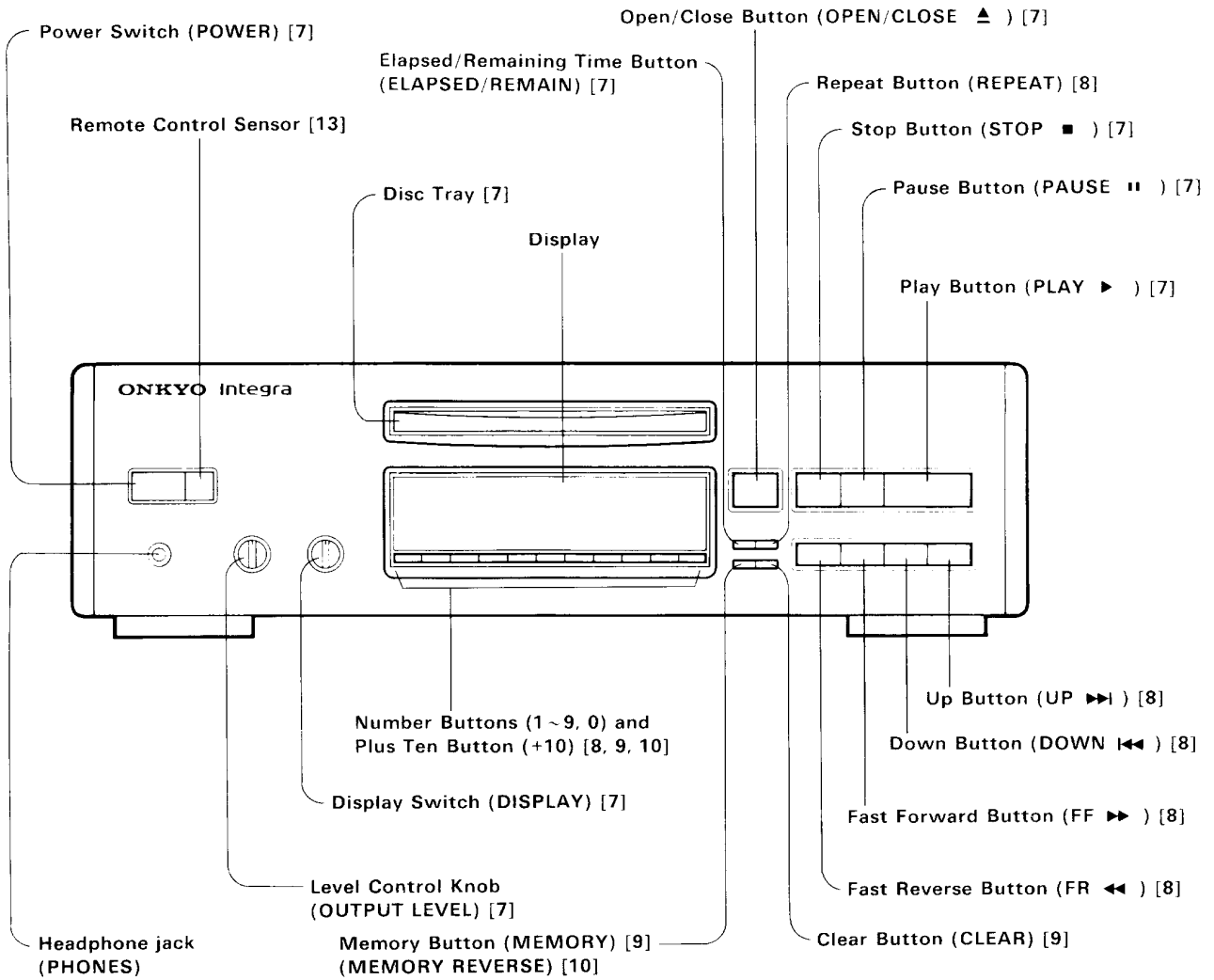

## Display

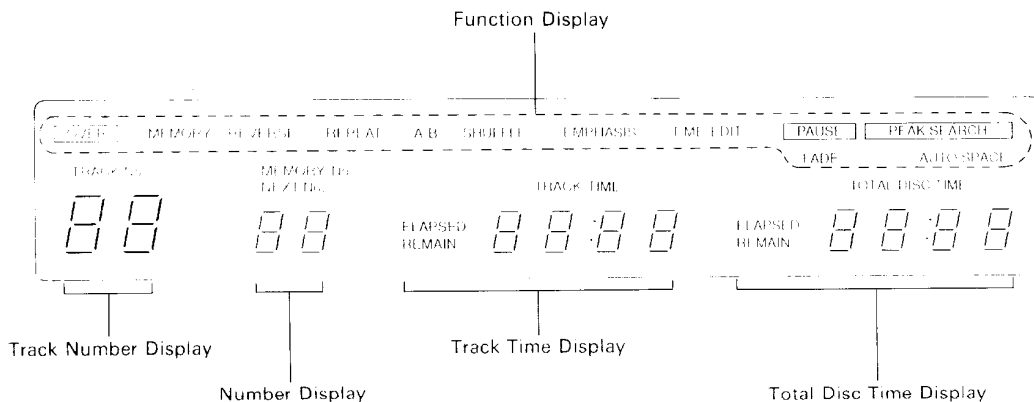

## Remote control transmitter RC-218C (RC-217C)

- Buttons not described below are operated in the same way as the buttons on the main unit.

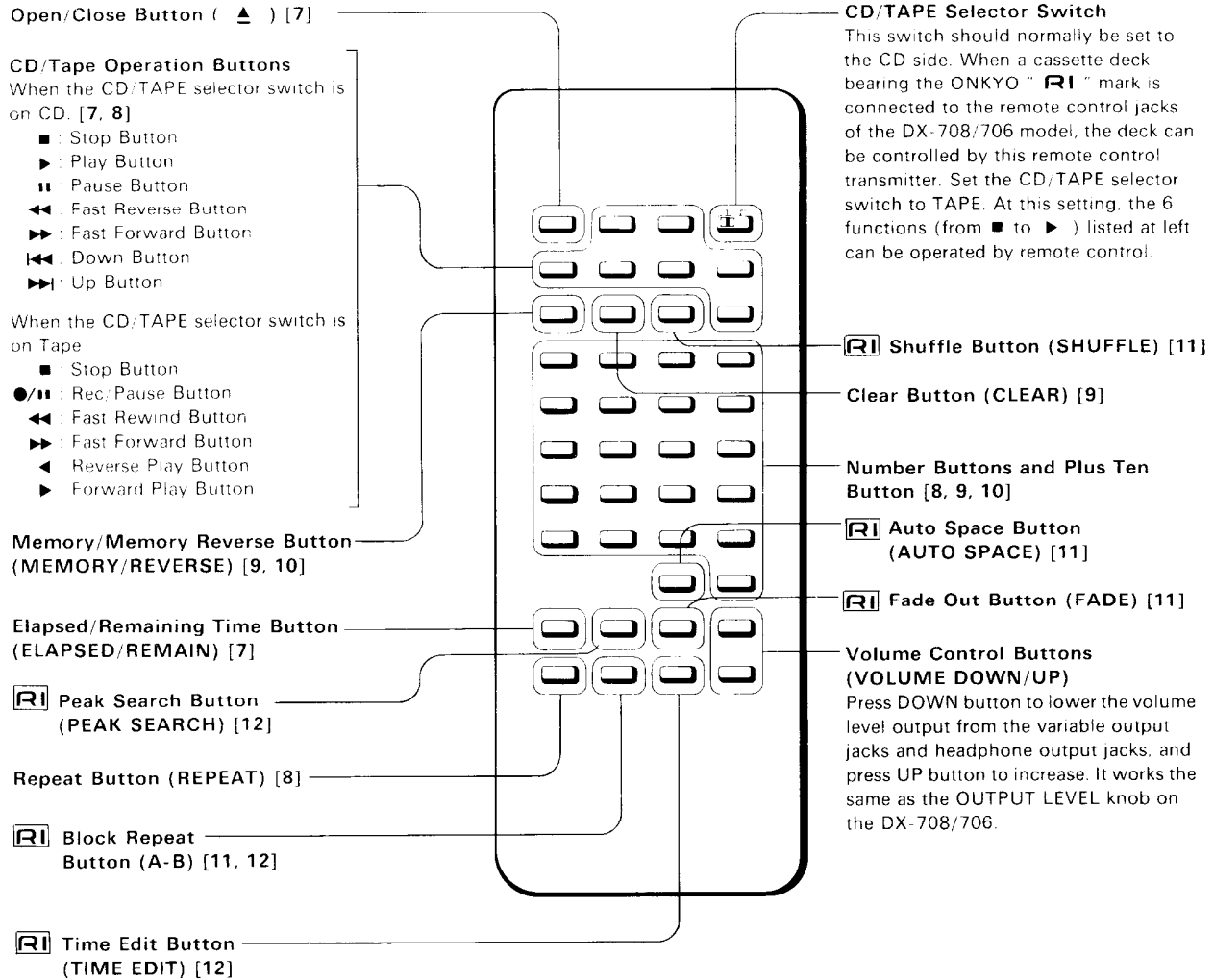

- The buttons shown with the **RI** mark in the illustration above control functions which can only be accessed using the remote control transmitter.
- The only difference between the RC-217C model and the RC-218C model is the Number Buttons. Both remote control transmitters can control the same functions.

## Handling Compact Discs

How to open a disc case and remove a disc.

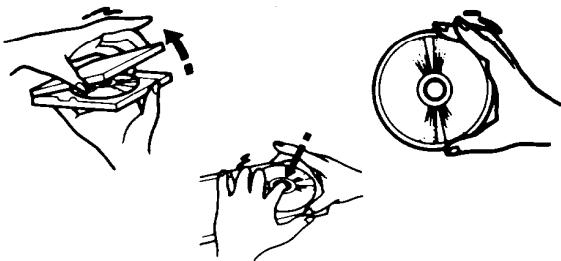

- Always handle compact discs with care so that they are not scratched, soiled or damaged.
- A dry soft cloth may be used to wipe dust, fingerprints, etc off the surface.
- Make absolutely sure not to use any type of volatile agent, such as thinner or benzine. Also avoid using a conventional record cleaner or antistatic agent.
- Avoid placing a disc in direct sunlight, and locations subject to extremely high humidity or low temperature.
- When a disc is going to be left unused for a long period of time, be sure not to leave it in the player but store it in the case.

## Common modes of operation

### To Load and Play a Disc (Normal Play)

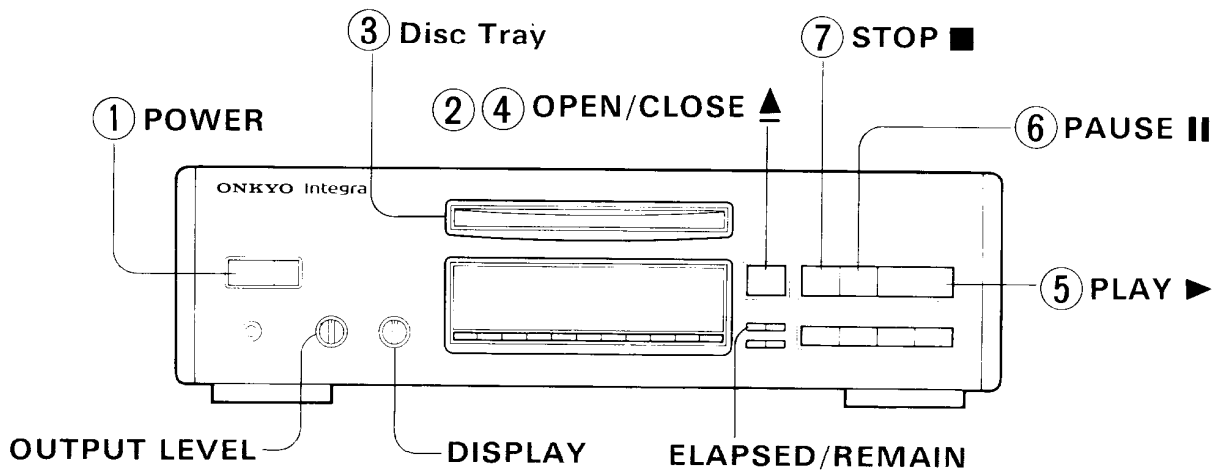

- ① Press the POWER switch to turn on the power.
- ② Press the OPEN/CLOSE ▲ button to open the Disc Tray.
- ③ Put the disc in the Disc Tray with its label facing up.
- ④ Press the OPEN/CLOSE ▲ button again to close the disc tray.
  - The disc is ready for play when the following indications appear on the display.

When the number of tracks exceeds 20, the **OVER** indicator lights

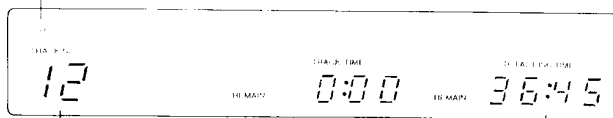

The total number of tracks on the disc

The total playing time of the disc

- If nothing is displayed, this may mean that the disc is upside down. If that is the case, take out the disc and put it in right side up.
- ⑤ Press the PLAY ► button.
    - The disc begins playing from the first track.
    - When you put the disc in the disc tray, if you press the PLAY ► button instead of the OPEN/CLOSE ▲ button, the tray is closed automatically and the first track begins to play.

Illuminated when playing the track which contains emphasis

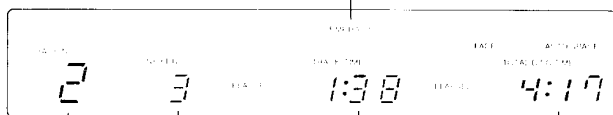

The current track number

Next track number

The total playing time which has elapsed from the start of play

The elapsed playing time for the track that is playing

- After a disc is played all the way to the end, the display resets to the initial condition when the disc is loaded.

- ⑥ Press the PAUSE ■■ button to stop the performance temporarily.
  - The PAUSE indicator lights and the playing stops temporarily.
  - To resume playing, press the PLAY ► button. The playing starts up again from exactly where it left off.
- ⑦ To stop the playing, press the STOP ■ button.

#### NOTE:

The DX-708/706 has an auto-play function. If a disc has already been inserted when the power is turned ON, performance will begin automatically.

#### ■ Volume adjustment

Use the OUTPUT LEVEL knob to adjust the output level (VARIABLE) and headphone output level.

#### ■ To change the display

Press the ELAPSED/REMAIN button to see the elapsed time (ELAPSED) on the TRACK TIME as well as the TOTAL DISC TIME. Press it again to see the remaining time (REMAIN) on both displays.

##### TRACK TIME

ELAPSED: Displays the elapsed time of the current track.

REMAIN: Displays the remaining time of the current track.

##### TOTAL DISC TIME

ELAPSED: Displays the total elapsed time from the beginning of play.

REMAIN: Displays the total remaining time until the end of play.

During memory play, this display shows the playing time remaining for the entire sequence of tracks programmed into memory.

#### NOTES:

- For a track beyond the 20th, TRACK TIME display shows "----:--".
- If the Total Remaining Time is more than 99 minutes 59 seconds, the TOTAL DISC TIME display shows "----:--".

#### ■ To change the brightness of the display

The DISPLAY switch can be used to change the brightness of the display.

- OFF: Turns the display completely OFF. When carrying out a button operation, the display will appear for a few seconds, then disappear again.
- NORMAL: Normal brightness
- DIM: Dimmer than normal...this can be used when the display is too bright relative to the lighting in the room



**To start from a specific track**

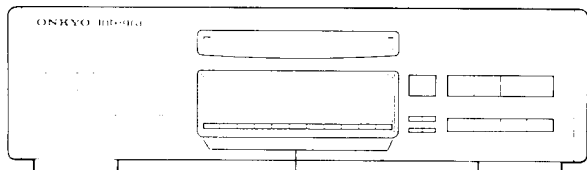

**Number Buttons  
and +10 Button**

Using the Number Buttons to select the desired track (Direct Play).

- Use +10 button to select a track with a track number of 10 or higher. For example, to select Track Number 30, press this button three times, and then press 0.

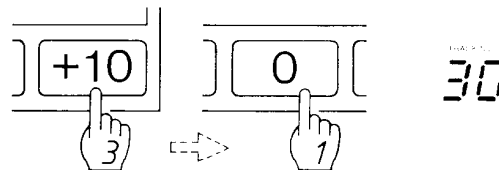

**To move forward or backward quickly during playing.**

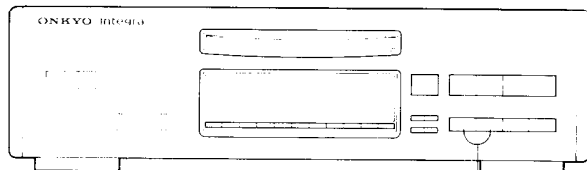

**FR ◀◀, FF ▶▶**

Press the FF ▶▶ button to fast forward.

Press the FR ◀◀ button to fast backward.

- The pickup continues to move rapidly forward or backward as long as you hold down the FF ▶▶ button or FR ◀◀ button.
- If you fast forward all the way to the end of the disc, the pickup stops.
- During memory play, when the pickup is forwarded to the end of the current track by pressing the FF ▶▶ button, the pickup comes to the next programmed track and normal playback begins. When the FR ◀◀ button is pressed, the pickup comes to the beginning of the current track and normal playback begins from this position.

**To return to the beginning of the track during playing or to skip to the next track**

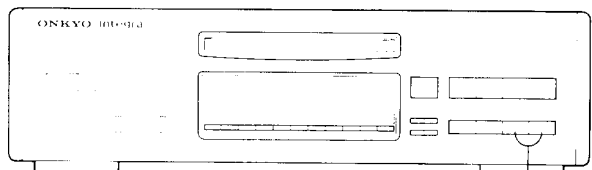

**DOWN ◀◀, UP ▶▶**

To skip to the next track, press the UP ▶▶ button.

- The playing of the current track is interrupted and the pickup moves to the beginning of the next track. During memory play the pickup moves to the beginning of the next track in memory.
- The pickup moves ahead one track each time you press the UP ▶▶ button.

To return to the beginning of the track during playing, press the DOWN ◀◀ button.

- The playing is interrupted and the pickup moves back to the beginning of the current track.
- If you press the DOWN ◀◀ button again before the pickup reaches the beginning of the current track or you press the DOWN ◀◀ button twice in a row, the pickup goes to the beginning of the previous track. During memory play the pickup goes to the beginning of the preceding track in memory.

**To listen to the tracks over and over**

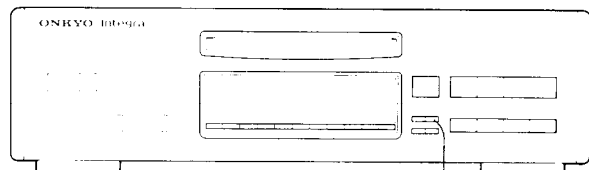

**REPEAT**

■ **To repeat performance of the disc being used**

Press the REPEAT button. (You can press this button before playing begins or in the middle of playing.)

- The REPEAT indicator lights and when the playing reaches the end of the disc, it starts again from the first track.
- During memory play when the performance reaches the end of the sequence of tracks programmed into memory it repeats that sequence.
- To stop the repeat play, press it again.

## Using the Memory function

To program and play the memory

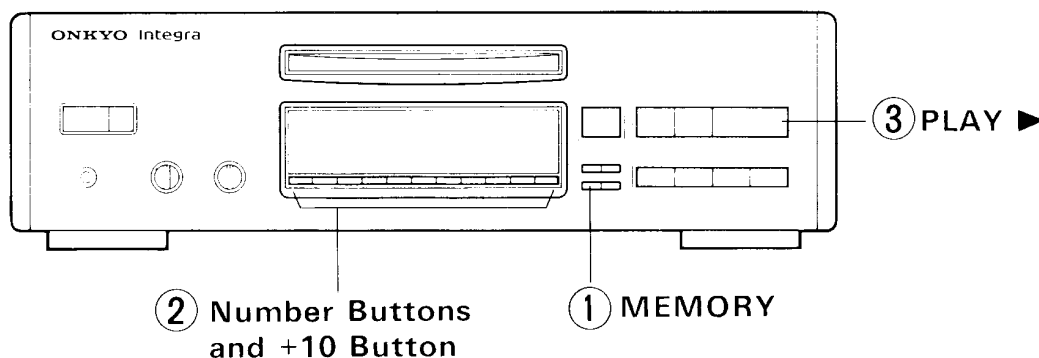

① Press the MEMORY button.

- The MEMORY indicator, MEMORY No. indicator will light. If the MEMORY button is pressed during play, the track being played is stored into memory and further tracks can be stored into memory with the operation in ② below.

② Select the track you want, using the Number Buttons and +10 Button.

Example: Memorizing track number 4 in memory channel 1

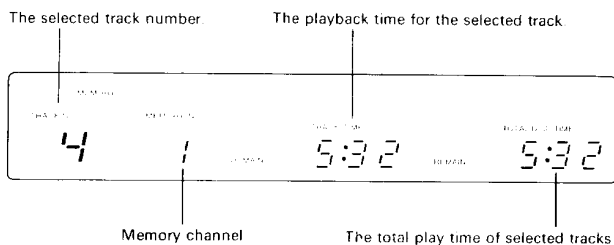

- To continue programming the memory, enter the number of the next selection to be programmed. Up to 20 tracks can be programmed in the memory by repeating this step. If attempting to program more than 20 tracks in the memory, *FL* will flash a few times on the MEMORY No. display to indicate that the memory is full.

③ Press the PLAY ► button.

- Play begins in the programmed order.

■ The display below is shown between tracks (or during the search process).

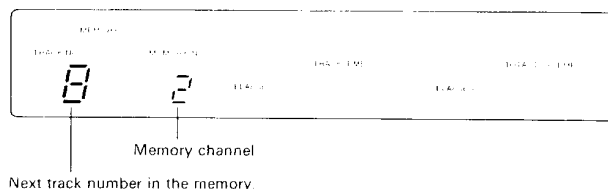

■ The display below is shown during playing.

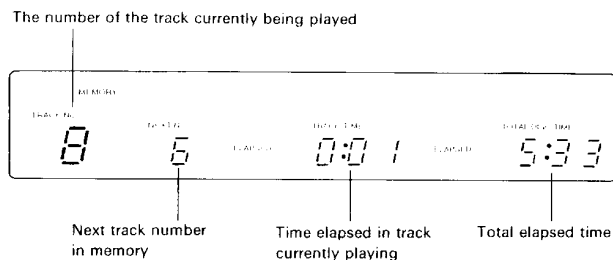

### To check the contents of the memory

1. If in memory play, press the STOP ■ button so that the play comes to a memory stop.
  - The last track number and its memory channel will appear on the TRACK No. display and the MEMORY No. display.
2. Press the FR ◀ or FF ▶ button.

### To cancel the contents of the memory

Press the CLEAR button.

- The last track in memory will be cancelled.
- During memory play, the current track in play and tracks previously programmed cannot be cancelled.
- Press the MEMORY button when the contents have been completely erased at one time. During memory play, however, normal play takes place, playing the current through the last tracks.

### To use the Memory Reverse Function

This function excludes the tracks from the memory, and programs other tracks on the disc. For example, if 10 out of 15 tracks on the disc are to be programmed in the memory, five unwanted tracks can be excluded, instead of programming 10 other tracks. The function is not activated during playback.

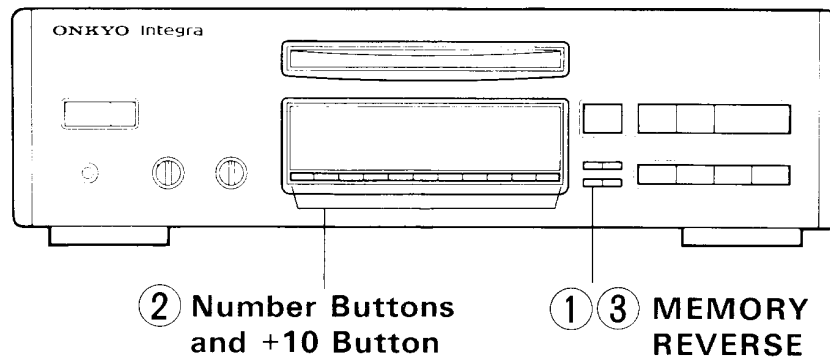

- ① Press the MEMORY button. (MEMORY indicator will light.)
- ② Program unwanted tracks by pressing the corresponding number buttons.
  - Five unwanted tracks, for example 3, 7, 12, 13 and 15 are programmed in the memory.

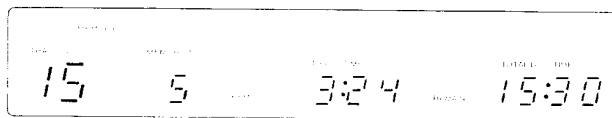

- ③ Press the MEMORY button again. (The REVERSE indicator, as well as the MEMORY indicator, will light.)
  - The tracks are stored into memory, except the ones which have already been programmed in step ②.



- 4 The tracks which have not been programmed will be memorized in numerical order automatically.

#### NOTES:

- If there are more than 20 tracks which have not been programmed, as many as 20 tracks will be memorized from the smaller number.
- To cancel the Memory Reverse mode, press the MEMORY button again. The first time the MEMORY button is pressed the MEMORY mode is initiated, the second time switches to MEMORY REVERSE and the third time cancels the memory mode.

## Functions which can be operated only by using the remote control transmitter

To playback in random order (Shuffle Play)

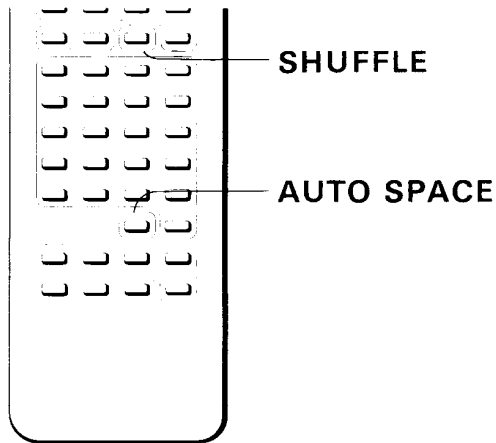

Press the SHUFFLE button.

- When this button is pressed, the SHUFFLE indicator lights up and the Auto Space function will insert 4 seconds of blank time between tracks during Shuffle play. Performance automatically begins.
- This function can be used in memory mode. In this case, the programmed tracks are played at random.

### NOTES:

- In the Shuffle Play Repeat mode, when all of the tracks have been played back once, the order will be changed and the playing will be repeated with a different track progression.
- The SHUFFLE mode will be cancelled when the SHUFFLE button is pressed again, or when all of the tracks have been played back and stopped.

Press the AUTO SPACE Button to switch the auto space function on and off. When the auto space function is operating, the AUTO SPACE indicator lights and a blank space lasting 4 seconds is inserted between tracks.

To use the Fade Out Function (FADE)

This function gradually decreases the volume. Set the volume knob to the maximum level first.

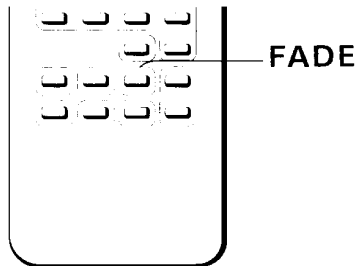

Press the FADE button during performance.

- Volume will decrease, with the FADE indicator flashing.
- The volume becomes minimum in approx. 10 seconds, and the performance will be stopped.
- This function is effective on the PHONES or VARIABLE OUTPUTS.

To repeat the block specified (Block Repeat)

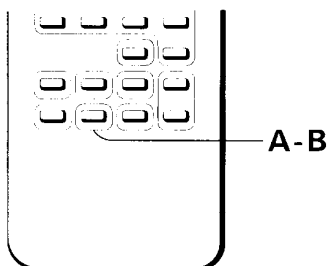

To set the beginning and ending points of the block, press the A-B button during playing. Press once at the beginning of the block repeat (point A) (block repeat indicator (A-B) flashes) and once again at the end of the block repeat (point B) (block repeat indicator remains lit). The section between A and B is played repeatedly. The ending point must be at a disc location after the starting point. To cancel the block repeat, press the A-B button once more. Disc play will then continue until the end of the disc.



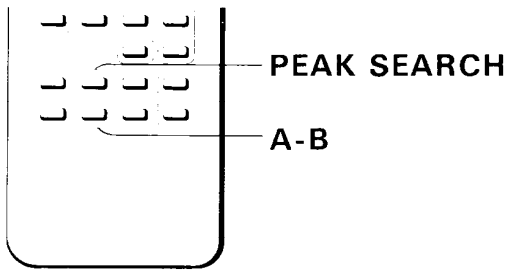

### NOTE:

- It is not possible to use the block repeat function during memory play, shuffle play, memory shuffle play and repeat play.

This function searches for the peak volume through the disc. (PEAK SEARCH)







Depending on the disc in play, memorizing of a level which is different from the maximum audible level could occur. This is due to the CD player's microprocessor memorizing inaccurate information because of flaws in the disc itself, or recording conditions. Under such circumstances, the recording level for the cassette tape may be entirely low, or else distortion or similar symptoms could arise on account of excessively high signal inputs. To avoid this, be sure to reset the recording level of the cassette deck in accordance with the symptoms.



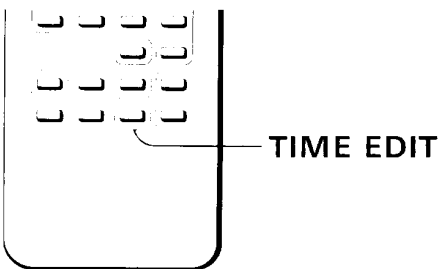



1. Press the PEAK SEARCH button.
  - The player checks the disc for level. The PEAK SEARCH indicator will flash during this operation. After checking, the indicator will light.
2. Press the A-B button.
  - The A-B indicator will light and  will flash on the MEMORY No., NEXT No. display.
3. Press the PLAY  button.
  - Part of the track with the largest volume on the disc will be played repeatedly for 6 seconds.
  - Refer to this level when recording the disc onto the cassette tape.
4. Press the STOP  button to stop performance. Repeat steps 2 and 3 to adjust the level again.
  - This level is memorized until the OPEN/CLOSE  button is pressed or the power is turned off.
  - Pressing the PEAK SEARCH button will turn off the indicator and the level will be released from the memory.
  - Pressing the A-B button after pressing the PLAY  button for performance will start the A-B repeat operation.

### To use the Time Edit Function

- This function is convenient for recording and editing tapes.
- Stop the playback, and cancel the memory, if necessary.



1. Press the TIME EDIT button.
  - TIME EDIT indicator will flash and the TRACK TIME will display C: --.
2. Specify the tape length on the "C: --" section using the +10 button and the Number buttons. For example, to input "46", press the +10 button 4 times and then press the Number button "6". Press the STOP  button and start the procedure from the beginning when the tape size has been input by mistake. Pressing the UP  or DOWN  button will carry out adjustment by one minute.
  - Automatic calculation of the number of tracks entered on the A and B sides begins. The order is the order in which the tracks are entered on the disc.
  - After calculating the recording track times, the MEMORY No. and NEXT No. display will be changed from (for example) A - 5, B - 5 to A - 6, B - 6. These illuminate in order. Also a number will be displayed to show how many tracks can be recorded on each side of the tape (A and B).

- When you want to add tracks, select one from either side by pressing the ELAPSED/REMAIN button and the track will be added at the end of the tracks which you have already selected. If no other tracks will fit on the tape, the **OVER** indicator will flash 3 - 4 times, indicating that no more tracks can be added.
  - Press the TIME EDIT button again to minimize the empty space on the tape. The TIME EDIT indicator will light and the micro computer will automatically arrange the order of the tracks. A total of up to 20 tracks can be recorded on side A and B. If a long tape is used, empty space may be left even after 20 tracks have been recorded. Checking the tape size and total disc time, and utilizing this function will optimize the edit conditions.
  - The contents of the TIME EDIT can be checked by pressing FR  or FF  buttons, following the same procedure as checking the contents of the memory. You can check which CD track number has been programmed in a certain tape track number, by pressing either FR  or FF  buttons. When the contents of the A side end, the contents of the B side will then be automatically displayed.
3. Press the PLAY  button. When playback of the last track on side A is completed, the pause mode is set automatically.
    - Press the PLAY  button to start playback again. The pause mode is canceled and side B plays.
    - TIME EDIT will be cancelled when recording on both sides has been finished or the STOP  button is pressed.

### NOTE:

The time edit mode does not function for discs with more than 20 tracks recorded on them, or when the first track is longer than half of the indicated time.

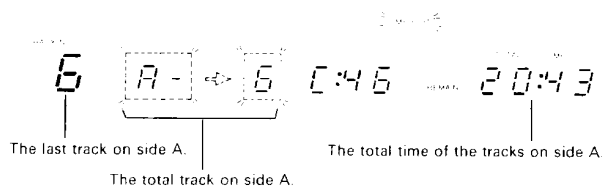

## Using the remote control transmitter

1. Remove the batteries if the remote control transmitter is not going to be used for a long time.
2. The batteries of the remote control transmitter must be replaced periodically.
3. This unit uses infrared rays. Therefore, commands may not be received properly if the front panel of this unit is exposed to bright light. To prevent this from occurring, place this unit so that it is not directly exposed to bright light.
4. If this unit is placed inside an audio rack behind a glass door, the door should not have colored glass or have any decorations on it, since this could shorten the range or prevent commands from being received.
5. Use of other infrared remote control devices in the same room may cause interference.
6. The transmitter operates up to a distance of about five meters (16 feet). The transmitting window must always be pointed at the reception window when a command is sent to the CD player.
7. If this remote control transmitter does not operate properly, confirm that the batteries are not dead. If the problem persists, contact your ONKYO Service Center.

### Transmitter Battery Insertion

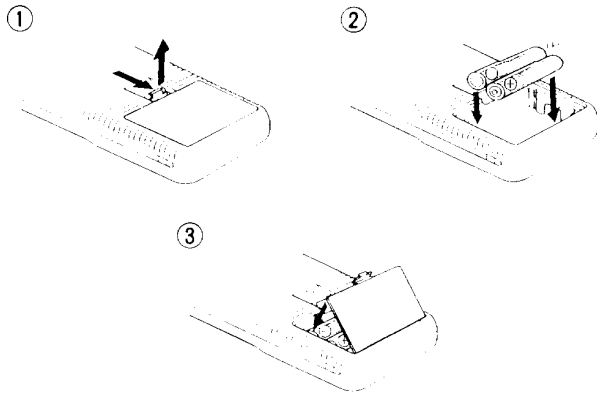

- ① Push the battery cover on the rear of the transmitter in the direction of the arrow and lift it up.
- ② Load the two batteries that came with the transmitter or two batteries listed in the table. Load them with the + and - ends facing as shown in the diagram.
- ③ Put the battery cover back in place.

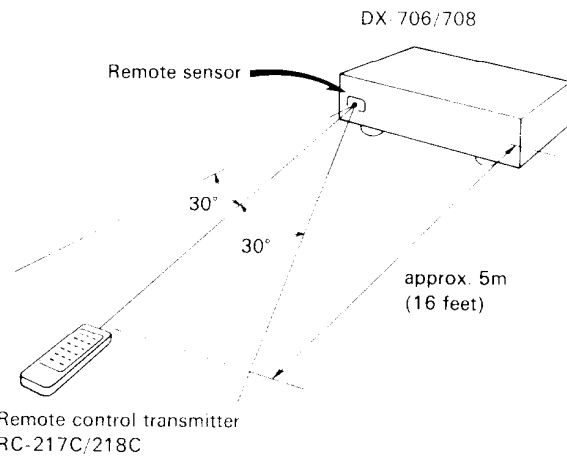

### Use of Batteries

- The remote control transmitter is powered by two batteries. Before using this unit for the first time, insert the two batteries (included) as shown in the diagram.
- Average battery life is about one year. This period may be shorter depending on the frequency of use and environment (temperature and humidity) in which the remote control transmitter is used.
- If the remote control transmitter does not operate even though front panel controls function normally, the batteries should be replaced. Use only batteries listed in the following chart.

Type	Voltage	Size
Manganese	1.5V	AA R6 UM-3

### NOTES:

1. Do not leave an expired battery in the case as it may leak or damage the battery case.
2. When inserting the batteries, be sure the (+) and (-) ends are properly aligned.
3. Do not use nickel-cadmium (rechargeable) batteries.
4. Do not use one specified (manganese) battery and one alkaline battery at the same time.
5. Replace both batteries at once; do not use one old and one new battery together.

## Troubleshooting guide

Trouble	Cause	Remedy
Power switch is pressed but power does not come on.	<ul style="list-style-type: none"> <li>● Power cord plug is not properly connected to AC outlet.</li> </ul>	<ul style="list-style-type: none"> <li>● Insert plug firmly.</li> </ul>
Disc loaded but play does not begin.	<ul style="list-style-type: none"> <li>● Disc is loaded upside-down.</li> <li>● Disc is dirty.</li> <li>● Dew on pickup.</li> </ul>	<ul style="list-style-type: none"> <li>● Load disc with the label side facing upward.</li> <li>● Clean the disc.</li> <li>● Place unit in warm place for about one hour.</li> </ul>
No sound.	<ul style="list-style-type: none"> <li>● Incomplete connections.</li> <li>● Improper input selector switch setting on amplifier.</li> </ul>	<ul style="list-style-type: none"> <li>● Insert all plugs firmly in jacks.</li> <li>● Set switch to proper position.</li> </ul>
Skipping.	<ul style="list-style-type: none"> <li>● Disc is dirty.</li> <li>● Disc is scratched.</li> <li>● Unit has been exposed to a strong bump.</li> </ul>	<ul style="list-style-type: none"> <li>● Clean the disc.</li> <li>● Use another disc.</li> <li>● Place the unit in a more stable location.</li> </ul>
Search time (when moving to a specific track) is extremely long.	<ul style="list-style-type: none"> <li>● Disc is dirty.</li> <li>● Disc is scratched.</li> </ul>	<ul style="list-style-type: none"> <li>● Clean the disc.</li> <li>● Use another disc.</li> </ul>
Track numbers cannot be stored in the memory.	<ul style="list-style-type: none"> <li>● A track number not on the disc is being used.</li> </ul>	<ul style="list-style-type: none"> <li>● Use only track numbers on the disc.</li> </ul>

## Specifications

### Compact Disc Player

### Model DX-708

Signal readout system: Optical non-contact  
 Reading rotation: About 500 - 200 r.p.m. (constant linear velocity)  
 Linear velocity: 1.2 - 1.4 m/s  
 Error correction system: Cross interleave Reed Solomon code  
 D/A converter: 1 BIT PWM × 2 AccuPulse Quarz System  
 Sampling frequency: 352.8 kHz (eight-times oversampling)  
 Number of channels: 2 (stereo)  
 Frequency response: 2 Hz - 20 kHz  
 Total harmonic distortion: 0.0020% (at 1 kHz)  
 Dynamic range: 100 dB  
 Signal to noise ratio: 110 dB  
 Channel separation: 110 dB (at 1 kHz)  
 Wow and Flutter: Below threshold of measurability  
 Output level: 2 volts r.m.s.

Power consumption: 21 watts  
 Power supply rating: AC 120V, 60Hz  
 Dimensions (W × H × D): 455 × 130 × 364 mm  
 17-15/16" × 5-1/8" × 14-5/16"  
 Weight: 8.8 kg, 19.4 lbs.

Supplied accessories:

- Output signal cord
- Remote control transmitter RC-218C
- UM-3/R6/AA
- **RI** remote control cable

### DX-706

Signal readout system: Optical non-contact  
 Reading rotation: About 500 - 200 r.p.m. (constant linear velocity)  
 Linear velocity: 1.2 - 1.4 m/s  
 Error correction system: Cross interleave Reed Solomon code  
 D/A converter: 1 BIT PWM × 2 AccuPulse Quarz System  
 Sampling frequency: 352.8 kHz (eight-times oversampling)  
 Number of channels: 2 (stereo)  
 Frequency response: 2 Hz - 20 kHz  
 Total harmonic distortion: 0.0020% (at 1 kHz)  
 Dynamic range: 100 dB  
 Signal to noise ratio: 110 dB  
 Channel separation: 110 dB (at 1 kHz)  
 Wow and Flutter: Below threshold of measurability  
 Output level: 2 volts r.m.s.

Power consumption: 21 watts  
 Power supply rating: AC 120V, 60Hz  
 Dimensions (W × H × D): 455 × 130 × 364 mm  
 17-15/16" × 5-1/8" × 14-5/16"  
 Weight: 8 kg, 17.6 lbs.

Supplied accessories:

- Output signal cord
- Remote control transmitter RC-217C
- UM-3/R6/AA
- **RI** remote control cable

Specifications and external appearance are subject to change without notice because of product improvements.

---

## **ONKYO CORPORATION**

International Division: Onarimon Yusen Bldg., 23-5, Nishi-Shimbashi 3-chome, Minato-ku,  
TOKYO 105, JAPAN Tel: 03-3432-6987 Fax: 03-3436-6979

### **ONKYO U.S.A CORPORATION**

200 Williams Drive, Ramsey, N.J. 07446, U.S.A.  
Tel: 201-825-7950 Fax: 201-825-8150

