

Stereo Cassette Tape Deck **K-505TX**

Instruction Manual

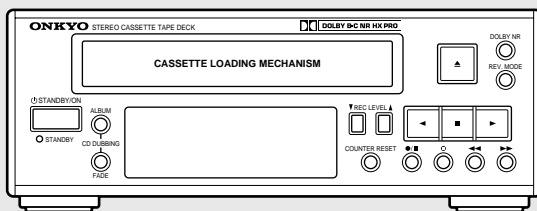

Before using

Connections

Operation

Other Information

Before using

Thank you for purchasing ...

Thank you for purchasing Onkyo K-505TX Stereo Cassette Tape Deck.

Please read this manual thoroughly before making connections and plugging in the unit.

Following the instructions in this manual will enable you to obtain optimum performance and listening enjoyment from your new K-505TX.

Please retain this manual for future reference.

Main Features

- Individually designed as the high-quality Separate Collection Series
- Digitalized counter
- Dolby* B NR and Dolby C NR systems that reduce tape background hiss
- Dolby HX Pro system that expands the dynamic range in higher frequencies and constantly adjusts recording conditions
- Manually adjustable recording levels with signal level indicator

Declaration of Conformity

We, ONKYO EUROPE
ELECTRONICS GmbH
INDUSTRIESTRASSE 20
82110 GERMERING,
GERMANY



declare in own responsibility, that the ONKYO product described in this instruction manual is in compliance with the corresponding technical standards such as EN60065, EN55013, EN55020 and EN61000-3-2, -3-3

GERMERING, GERMANY

A.HORIUCHI

ONKYO EUROPE ELECTRONICS GmbH

*Dolby noise reduction and HX Pro headroom extension manufactured under license from Dolby Laboratories Licensing Corporation. HX Pro originated by Bang and Olufsen.

"Dolby," the double-D symbol and "HX Pro" are trademarks of Dolby Laboratories Licensing Corporation.

WARNING:

TO REDUCE THE RISK OF FIRE OR ELECTRIC SHOCK, DO NOT EXPOSE THIS APPLIANCE TO RAIN OR MOISTURE.

CAUTION:

TO REDUCE THE RISK OF ELECTRIC SHOCK, DO NOT REMOVE COVER (OR BACK). NO USER-SERVICEABLE PARTS INSIDE. REFER SERVICING TO QUALIFIED SERVICE PERSONNEL.



WARNING
RISK OF ELECTRIC SHOCK
DO NOT OPEN

AVIS
RISQUE DE CHOC ELECTRIQUE
NE PAS OUVRIR



The lightning flash with arrowhead symbol, within an equilateral triangle, is intended to alert the user to the presence of uninsulated "dangerous voltage" within the product's enclosure that may be of sufficient magnitude to constitute a risk of electric shock to persons.

The exclamation point within an equilateral triangle is intended to alert the user to the presence of important operating and maintenance (servicing) instructions in the literature accompanying the appliance.

Important Safeguards

1. **Read Instructions** – All the safety and operating instructions should be read before the appliance is operated.
2. **Retain Instructions** – The safety and operating instructions should be retained for future reference.
3. **Heed Warnings** – All warnings on the appliance and in the operating instructions should be adhered to.
4. **Follow Instructions** – All operating and use instructions should be followed.
5. **Water and Moisture** – The appliance should not be used near water – for example, near a bathtub, washbowl, kitchen sink, laundry tub, in a wet basement, or near a swimming pool, and the like.
6. **Carts and Stands** – The appliance should be used only with a cart or stand that is recommended by the manufacturer.
- 6A. An appliance and cart combination should be moved with care. Quick stops, excessive force, and uneven surfaces may cause the appliance and cart combination to overturn.

**PORTABLE CART
WARNING**

S3125A
7. **Wall or Ceiling Mounting** – The appliance should be mounted to a wall or ceiling only as recommended by the manufacturer.
8. **Ventilation** – The appliance should be situated so that its location or position does not interfere with its proper ventilation. For example, the appliance should not be situated on a bed, sofa, rug, or similar surface that may block the ventilation openings; or if placed in a built-in installation, such as a bookcase or cabinet that may impede the flow of air through the ventilation openings, there should be at least 5 cm (2 in.) of free space behind the appliance.
9. **Heat** – The appliance should be situated away from heat sources such as radiators, heat registers, stoves, or other appliances (including amplifiers) that produce heat.
10. **Power Sources** – The appliance should be connected to a power supply only of the type described in the operating instructions or as marked on the appliance.
11. **Polarization** – If the appliance is provided with a polarized plug having one blade wider than the other, please read the following information: The polarization of the plug is a safety feature. The polarized plug will only fit the outlet one way. If the plug does not fit fully into the outlet, try reversing it. If there is still trouble, the user should seek the services of a qualified electrician. Under no circumstances should the user attempt to defeat the polarization of the plug.
12. **Power-Cord Protection** – Power-supply cords should be routed so that they are not likely to be walked on or pinched by items placed upon or against them, paying particular attention to the cords at plugs, convenience receptacles, and the point where they exit from the appliance.
13. **Cleaning** – The appliance should be cleaned only as recommended by the manufacturer.
14. **Nonuse Periods** – The power cord of the appliance should be unplugged from the outlet when left unused for a long period of time.
15. **Object and Liquid Entry** – Care should be taken so that objects do not fall and liquids are not spilled into the enclosure through openings.
16. **Damage Requiring Service** – The appliance should be serviced by qualified service personnel when:
 - A. The power-supply cord or the plug has been damaged; or
 - B. Objects have fallen or liquid has been spilled into the appliance; or
 - C. The appliance has been exposed to rain; or
 - D. The appliance does not appear to operate normally or exhibits a marked change in performance; or
 - E. The appliance has been dropped or the enclosure damaged.
17. **Servicing** – The user should not attempt to service the appliance beyond that described in the operating instructions. All other servicing should be referred to qualified service personnel.

Precautions

1. Warranty Claim

You can find the serial number on the rear panel. In case of warranty claim, please report this number.

2. Recording Copyright

Recording of copyrighted material for other than personal use is illegal without permission of the copyright holder.

3. Deck Location

- Do not use or leave in direct sunlight or in other places subject to high temperature and humidity. The unit should also not be left in potentially hot places such as near heating appliances. Excessive heat and moisture can lead to internal damage and serious malfunctions (this also applies to cassette tapes). The recommended ambient temperature range is 5°C to 35°C.
- Avoid damp and dusty places and locations prone to vibrations.
- Be extremely careful with the recording/playback heads. Clean and demagnetize them regularly, but under no circumstances should magnets or other metals be used anywhere near the heads.
- This unit is extremely sensitive to magnetic fields, so do not use near large speakers or other devices which generate magnetic fields.
- Hum may even be induced by magnetic flux leakage from the power transformer in certain amplifiers. Therefore, this unit should also be kept clear of the amplifier.
- Do not remove the cabinet case. If any of the internal parts are handled, there is a considerable danger of electric shock.

4. Cassettes to Avoid:

- Cassettes with poorly formed cases that rattle during rewind and fast forward.
- Low cost cassettes with no guide roller or pressure pad spring should never be used for stereo.
- C-120 cassettes because the tape and the coating are extremely thin, distortion levels are high. Also, even a slight stretching of the tape will make it susceptible to being caught up in the pinch roller and capstan.
- Endless tapes, if used for a long period of time, can overheat.

5. Care

From time to time you should wipe the front and rear panels and the cabinet with a soft cloth. For heavier dirt, dampen a soft cloth in a weak solution of mild detergent and water, wring it out dry, and wipe off the dirt. Following this, dry immediately with a clean cloth. Do not use rough material, thinners, alcohol or other chemical solvents or cloths since these could damage the finish or remove the panel lettering.

6. Power

WARNING

BEFORE PLUGGING IN THE UNIT FOR THE FIRST TIME, READ THE FOLLOWING SECTION CAREFULLY.

The voltage of the available power supply differs according to country or region. Be sure that the power supply voltage of the area where this unit will be used meets the required voltage (e.g., AC230V 50Hz or AC120V 60Hz) written on the rear panel.

For British Model

Replacement and mounting of an AC plug on the power supply cord of this unit should be performed only by qualified service personnel.

IMPORTANT:

The wires in the mains lead are coloured in accordance with the following code:

Blue: Neutral

Brown: Live

As the colours of the wires in the mains lead of this appliance may not correspond with the coloured markings identifying the terminals in your plug, proceed as follows:

The wire which is coloured BLUE must be connected to the terminal in the plug which is marked with the letter N or coloured BLACK.

The wire which is coloured BROWN must be connected to the terminal in the plug which is marked with the letter L or coloured RED.

IMPORTANT

A 5 ampere fuse is fitted in this plug. Should the fuse need to be replaced please ensure that the replacement fuse has a rating of 5 amperes and that it is approved by ASTA or BSI to BS 1362. Check for the ASTA mark or the BSI mark on the body of the fuse.

IF THE FITTED MOULDED PLUG IS UNSUITABLE FOR THE SOCKET OUTLET IN YOUR HOME THEN THE FUSE SHOULD BE REMOVED AND THE PLUG CUT OFF AND DISPOSED OF SAFELY. THERE IS A DANGER OF SEVERE ELECTRICAL SHOCK IF THE CUT OFF PLUG IS INSERTED INTO ANY 13 AMPERE SOCKET.

If in any doubt please consult a qualified electrician.

For Canadian model

For models having a power cord with a polarized plug:

CAUTION: TO PREVENT ELECTRIC SHOCK, MATCH WIDE BLADE OF PLUG TO WIDE SLOT, FULLY INSERT.

Modele pour les Canadien

Sur les modeles dont la fiche est polarisée:

ATTENTION: POUR ÉVITER LES CHOCS ÉLECTRIQUES, INTRODUIRE LA LAME LA PLUS LARGE DE LA FICHE DANS LA BORNE CORRESPONDANTE DE LA PRISE ET POUSSER JUSQU'AU FOND.

Table of contents

Before Using

Checking the supplied accessories Below

Connections

Connecting to the ONKYO Separate Collection Series components 6

Connecting to other components 7

Operation

Playing a tape 9

Recording 12

CD dubbing with ONKYO Separate Collection Series 16

CD/MD Synchro Recording with ONKYO Separate Collection Series . 20

Other Information

Handling cassette tapes/Maintenance 22

Troubleshooting 23

Specifications 25

Index to parts and controls 26

Checking the supplied accessories

Check that the following accessories are supplied with this unit.

- **RI remote control cable** × 1

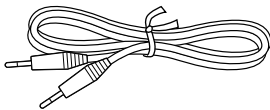

- **Audio connection cable** × 2

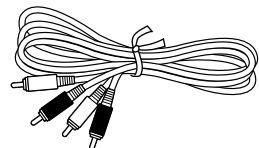
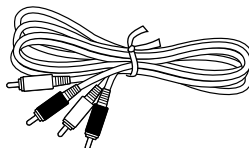

Connecting to the ONKYO Separate Collection Series components

This section introduces you to the other ONKYO Separate Collection Series system components and their convenient system functions. For the actual connecting instructions and detailed information, please refer to the Instruction Manual of the Integrated Stereo Amplifier A-905TX.

The following ONKYO Separate Collection Series components are commercially available:

- A-905TX Integrated Stereo Amplifier (Not available in U.S.A., Canada and Europe)
- T-405TX Stereo Tuner (Not available in U.S.A., Canada and Europe)
- C-705TX Compact Disc (CD) Player (Not available in U.S.A. and Canada)
- C-707CHX Compact Disc (CD) Changer (Only available in U.S.A. and Canada)
- MD-105TX Minidisc (MD) Recorder (Not available in U.S.A., Canada and Europe)
- R-805TX FM STEREO/AM TUNER AMPLIFIER (Not available in U.S.A. and Canada)
- CDR-205TX ... Compact Disc (CD) Recorder (Not available in U.S.A. and Canada)
The R-805TX (FM STEREO/AM TUNER AMPLIFIER) can be connected in substitution for the A-905TX and T-405TX.

Note that the available components may vary according to the area.

Combination use of the unit with the above system components enables you to operate the following convenient functions:

• **Auto Power On**

- You can turn on the amplifier by pressing the STANDBY/ON button on one of the system components. (The amplifier's POWER switch must be set to ON.)
- You can turn on all the system components at the same time by pressing the STANDBY/ON button on the amplifier. (The amplifier's POWER switch must be set to ON.)
You can turn off each component not in use independently afterwards.

• **Direct Change**

Press the following button on the component you want to operate to switch the amplifier's input selector automatically to that component:

- The play button on the unit, CD player, or MD recorder, or
- The PRESET ◀/▶ buttons on the tuner.

• **Remote Control Operation**

All the system components can be operated using the remote controller supplied with the A-905TX or R-805TX.

• **Program Timer**

You can operate timer playback and recording using T-405TX or R-805TX (refer to the Instruction Manual of the T-405TX or R-805TX).

• **Sleep Timer**

You can fall asleep to a music/radio program using the timer (refer to the Instruction Manual of the T-405TX or R-805TX).

• **CD Dubbing**

Simple CD dubbing with this unit is possible with the pressing of a single button (see page 16).

• **CD/MD Synchro Recording**

When using this unit to record a tape from the CD player or MD recorder, you can start recording automatically (while the unit is in recording standby) at the same time as you start playing a CD or MD (see page 20).

Note

When connected to the R-805TX, if the ENERGY SAVE function of the R-805TX is activated, even if the STANDBY/ON button of the main unit is pressed, the power will not be turned on. To turn on the power, the STANDBY/ON button of the R-805TX must be pressed. (For detailed information see the R-805TX Instruction Manual.)

Connecting to other components

Before connecting

- Do not connect the AC power cord (mains lead) until you have completed all the other connections including the **RI** connections on the next page.
- On each pair of connectors, a red connector (marked R) corresponds to the right channel, and a white connector (marked L) to the left channel. Connect white plugs of audio connection cables to L connectors and connect red plugs of audio connection cables to R connectors .

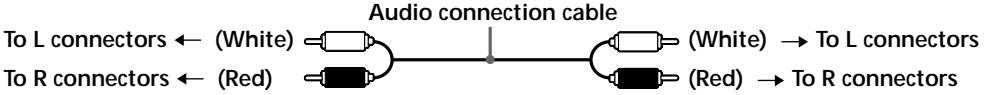

- Insert the plug securely. If the connection is incomplete, noise or malfunction may result.

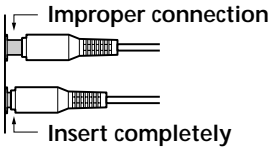

- Bundling an audio connection cable with the power cord or speaker cord may degrade the sound quality.
- To use the unit with the other ONKYO Separate Collection Series components, follow the connection diagram in the A-905TX or R-805TX instruction manual to connect the unit to the system.

Note:

The 230-240 V model is shown in the following illustrations.

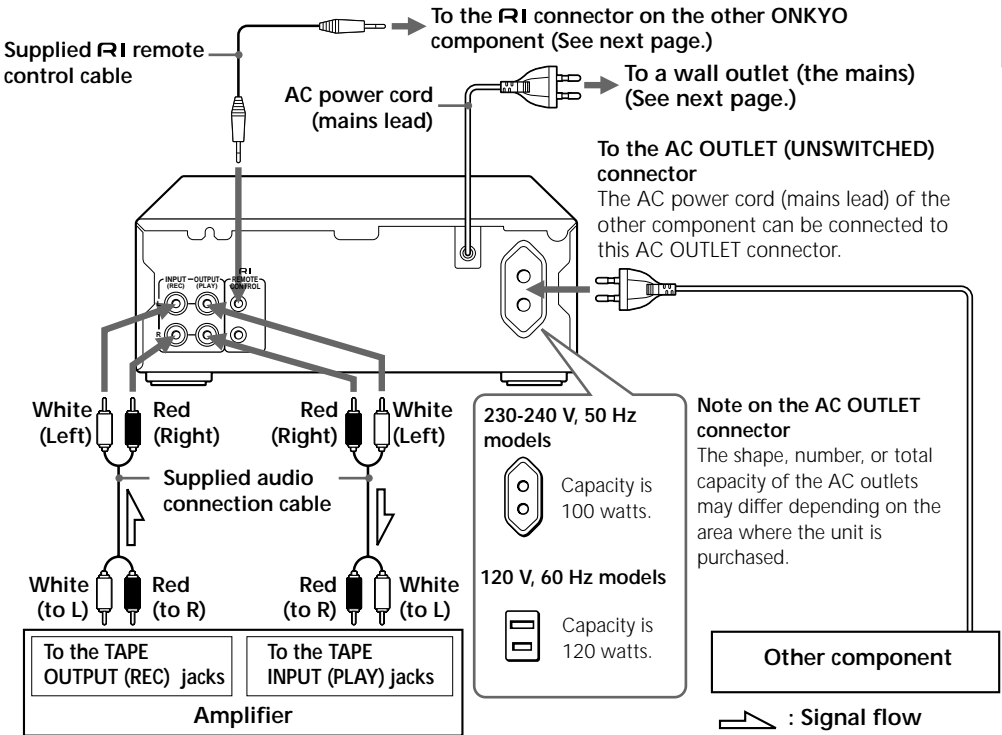

Connecting to other components (continued)

Connecting the **RI** connectors

If you are using other ONKYO components equipped with **RI** connectors, you can control these components using the amplifier's remote controller.

Before connecting

- The amplifier must be connected in the **RI** system hookups for **RI** control operations.
- Each component has two **RI** connectors. There is no difference between these connectors.
- The components may be connected in any order.
- The hookups on the previous page are necessary independently of the **RI** system hookups.

The illustration below is an example of a **RI** hookup. With these hookups, you can operate the CD Synchro Recording; when recording a tape with this unit from the CD player, you can start recording automatically (while the unit is in recording standby) at the same time as you play the CD (see "CD Synchro Recording" on page 14).

For CD Synchro Recording, at least the unit, amplifier, and CD player must be connected with the **RI** connectors.

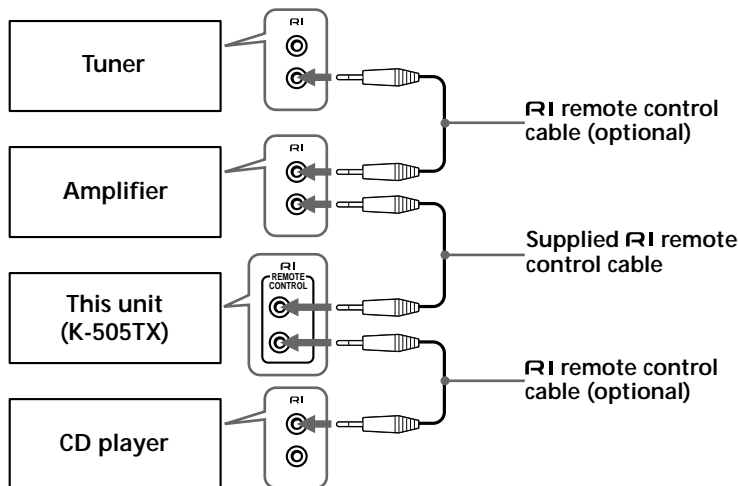

Note

An **RI** remote control cable equipped with a 1/8 in. (3.5mm) diameter miniature two-conductor phone plug is included with this unit and with every compact disc player and tuner that bears the **RI** mark.

Connecting the AC power cord (mains lead) to the wall outlet (the mains)

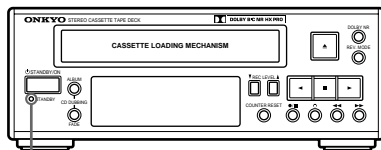
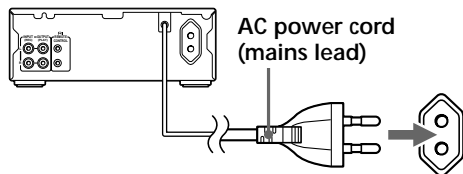

The **STANDBY** indicator lights

Note

If you connect the AC power cord (mains lead) to the AC outlet of another component, the component's AC power cord (mains lead) must be connected to the wall outlet (the mains) to supply power to the unit. If the component has a main power switch, it must be set to On.

Operation

Playing a tape

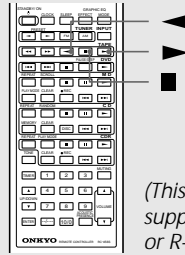
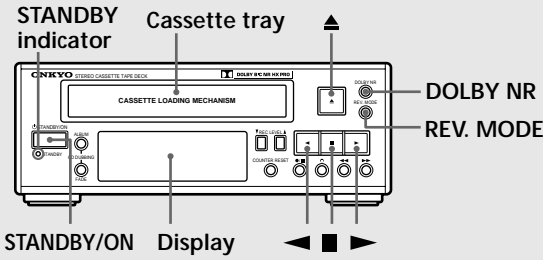

(This remote controller is supplied with A-905TX or R-805TX.)

1 Insert a recorded cassette.

- 1 Press ▲, to bring out the cassette tray.
The unit turns on automatically if it is in standby. (The STANDBY indicator goes out, then the display lights.)
- 2 Place the cassette on the tray with the tape side facing towards the unit.
The side of the cassette facing up is the forward side.
- 3 Press ▲ to close the tray.



Note
The tape side of the cassette must face the unit. Never turn it the other way when you put it on the tray.

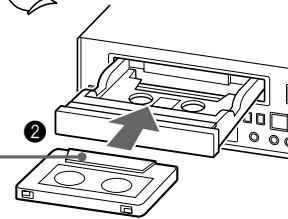

2 Press DOLBY NR until the proper Dolby NR mode lights in the display, matching the mode the tape is recorded in.

Each press changes the indicator in the display in the following order:

□□ B (Dolby B NR) → □□ C (Dolby C NR)

↑ The indicator goes off. ←

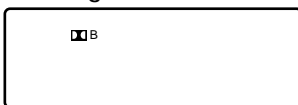

3 Press REV. MODE to select the reverse mode.

Each press changes the indicator in the display; ↻ or ↺.



- **When ↻ is lit**
The unit plays both sides of the tape eight times and stops.
- **When ↺ is lit**
The unit will stop playing when the playing side of the tape reaches its end.

4 Press ▶ to start playback (or ◀ to play the reverse side).

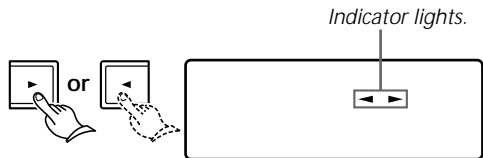

Note

No sound is reproduced while the unit is rotating the playing head for reverse side playback.

To stop playback

Press ■. (Press this button to stop whatever the tape operation is.)

To turn off the unit.

Press STANDBY/ON.

(Continued on the next page)

Playing a tape (continued)

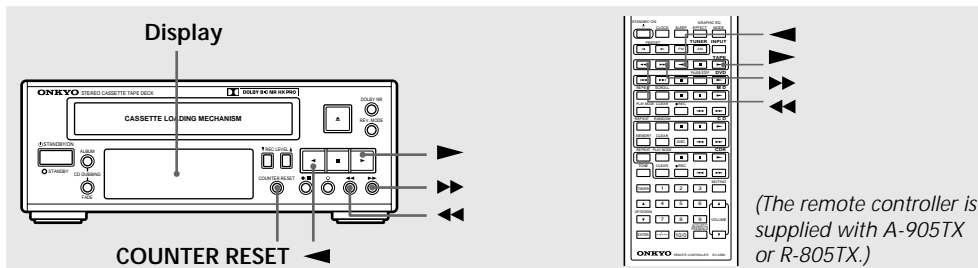

Starting playback in other ways – One-touch playback

Press ► to start playback (or ◀ to play the reverse side) after step 1-2 on the previous page, then the tray will close automatically and playback will start.

If the cassette is already in the unit

Simply press ► to start playback (or ◀ to play the reverse side).

- The unit turns on automatically if it is in standby.
- If the unit is connected to the amplifier A-905TX with the **RI** connectors, both the unit and amplifier turn on automatically. (The amplifier's POWER switch must be set to ON for this function.)

Checking the digital counter

At the point you want to start counting, press COUNTER RESET to set the counter to zero.

COUNTER RESET



Fast-forwarding the tape

When the following indicator is lit in the display



While the tape is stopped, press



Rewinding the tape

When the following indicator is lit in the display



While the tape is stopped, press



About Automatic Tape Type Detection

The unit automatically detects the type of the cassette, NORMAL (TYPE I), HIGH (TYPE II), or METAL TAPE (TYPE IV), and conforms to the tape type. The unit identifies the tape type by means of the detection holes of the cassette (see the illustration in "Preventing an accidental recording" on page 15).

Notes

Automatic Tape Type Detection doesn't operate, if:

- one or both of the detection holes are covered (e.g. with adhesive tape), or
- the cassette doesn't meet this tape standard.

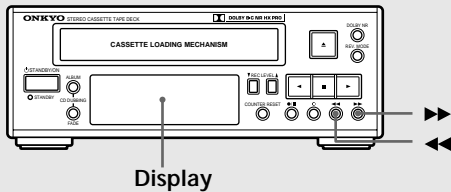

Display

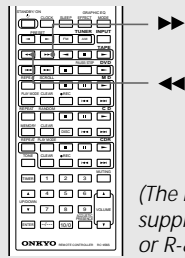

(The remote controller is supplied with A-905TX or R-805TX.)

Skipping to the track you want to listen to during playback - Skip Play

Playing the currently-playing track from the beginning

When the following indicator is lit in the display	During playback, press
▶	◀◀
◀	▶▶

To skip backward successively to the track you want

During playback, press ◀◀ or ▶▶ according to the above table repeatedly until the desired number (up to 15) appears in the display. The number indicates the relative position of the track from the current one.

e.g. When ▶ is lit

e.g. When ◀◀ is pressed three times.

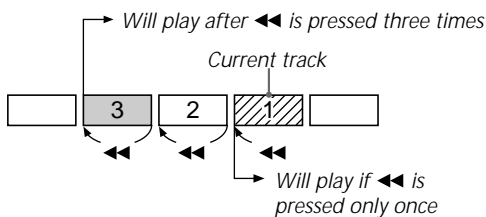
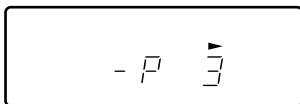

Note

The unit recognizes the position of the track from the current one by blank sections between tracks. Therefore, it may not operate properly, if:

- the blank section between the tracks is too short,

- the music is intermittent, or the recording is not music (e.g. narration),
- the blank section is filled with excessive noise, or
- a small sound suddenly follows a loud sound (in this case, the unit might recognize the small sound section as blank by mistake).

Skipping to the next track during playback

When the following indicator is lit in the display	During playback, press
▶	▶▶
◀	◀◀

To skip forward successively to the track you want

During playback, press ▶▶ or ◀◀ according to the above table repeatedly until the desired number (up to 15) appears in the display. The number indicates the relative position of the track from the current one.

e.g. When ▶ is lit.

e.g. When ▶▶ is pressed three times.

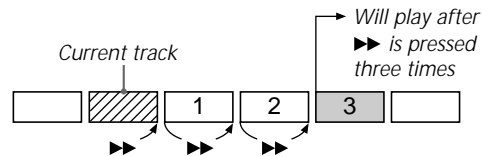
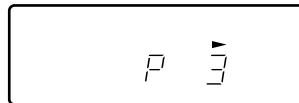

Note

See "Note" in "Playing the currently-playing track from the beginning."

Recording

STANDBY/ON

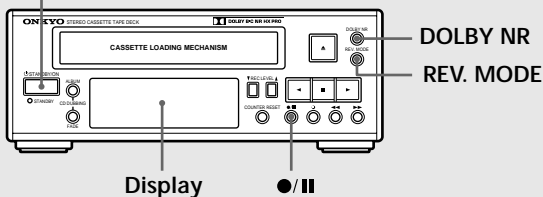

Before starting

The shadowed steps are operations with the other components.

1 Press STANDBY/ON, if the unit is not turned on.



2 Insert a cassette with its erasure prevention tabs in place, following step 1 in "Playing a tape" on page 9.

See "Preventing an accidental recording" on page 15.

3 Press REV. MODE to select the reverse mode.

Each press changes the indicator in the display: ↻ or ⇄.

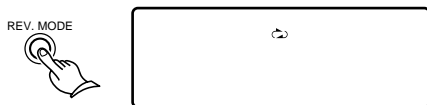

- **When ↻ is lit**

The unit records both sides of the tape and stops.

Note

If you start recording on the reverse side of the tape in step 11, the unit will record only the reverse side and then stop, even if the reverse mode is set to ↻.

- **When ⇄ is lit**

The unit stops after recording one side of the tape.

4 Prepare the source component you want to record from.

- **Tuner**
Tune into the station you want to record.
- **CD player/MD recorder**
Insert a CD (MD) into the CD player (MD recorder).
- **Cassette tape deck/DAT**
Insert a recorded cassette into the cassette tape deck or DAT.

5 Select the component you prepared in the above step with the input selector on the amplifier.

6 Start playing the source you prepared in step 4, for recording adjustment.

7 Press ●/|| to put the unit in recording pause.

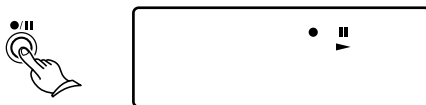

8 Press DOLBY NR until the Dolby NR mode you want to record with lights in the display.

See "Dolby Noise Reduction Systems" on page 15 for Dolby NR mode information. Each press changes the indicator in the display in the following order:

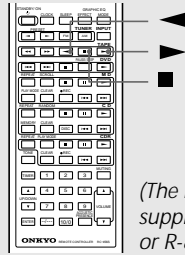
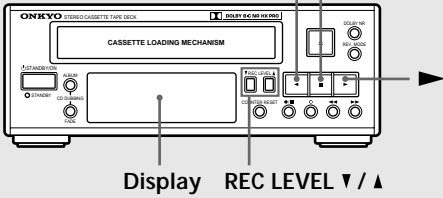

(The remote controller is supplied with A-905TX or R-805TX.)

□□ B (Dolby B NR) → □□ C (Dolby C NR)
 ↑ The indicator goes off. ↓

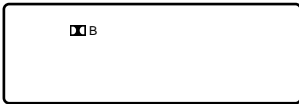

Note

- If you do not set the proper recording level for the tape type, the sound may be distorted.
- After setting the recording level, if the unit is unplugged, the recording level will revert to its default value (20).

Tip

To immediately set the recording level to "00," press and hold REC LEVEL ▼ and ▲ at the same time for more than two seconds. This is convenient when recording with "00" recording level to erase the recorded tape.

9 Press REC LEVEL ▼ / ▲ to adjust the recording levels (0 to 50).

The recording level indication appears in the display instead of the digital counter. The level between 14 and 24 should suit most recording cases.



Recording level indication



Incoming signal level indicator

- **When using NORMAL (TYPE I) or HIGH (TYPE II) type cassette**
 Check the incoming signal level indicator. The bottom red bar should light constantly, and the second red bar from the bottom should light occasionally.
- **When using METAL TAPE (TYPE IV) cassette**
 Check the incoming signal level indicator. The second red bar from the bottom should light constantly, and the third red bar from the bottom should light occasionally.

10 Set the source component to start playing at the point you want to start recording from.

11 Press ► to start recording (or ◀ to record on the reverse side).

Let the tape run for a while if you are starting recording from the beginning of the tape. This is because no sound will be recorded on the leader.

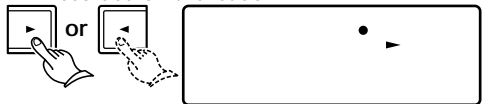

12 Start playing the source.

To stop recording
 Press ■.

Recording (continued)

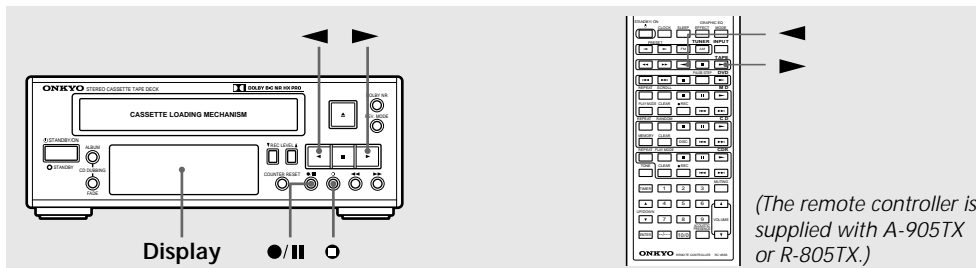

Inserting a blank section between tracks – *Auto Space*

To use Skip Play on page 11, there must be sufficient blank sections between tracks. If the recording source doesn't have enough blank sections between tracks, or if you are recording from various sources onto one tape, you need to make proper blank sections between tracks.

1 While recording or recording pause, press **○** at the point when one track has finished.

Pause the playing source at the same time.

After the unit has completed making a blank section of about five seconds, it enters recording pause automatically.

The recording side indicator flashes while the unit is making the blank section.

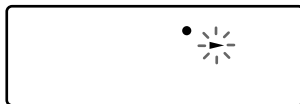

2 Press **▶** or **◀** (the button indicated in the display) to restart recording.

Restart playing the source at the same time.

To make the blank section less than five seconds

Press **●/||** to enter the unit into recording pause, or **▶** or **◀** (the button indicated in the display) to start recording before five seconds elapse after you press **○** in step **1** above.

To make the blank section longer than five seconds

Press and hold **○** in step **1** above until the desired time has elapsed. The unit enters recording pause immediately after you release the button.

CD Synchro Recording

The **RI** hookups are necessary for these operations. See "Connecting to the **RI** connectors" on page 8.

Operations

The operations for CD Synchro Recording are almost the same as the recording operations starting from page 12.

The differences are follows:

- Skip step **11** and go to step **12**.
When you start playing the CD in step **12**, CD recording will start at the same time.
- Recording starts in the direction retained in the unit memory in step **11**. If the tape side you want to record on doesn't match the tape transport direction indicated in the display, press and hold **●/||**, then press **▶** or **◀** to change the starting direction in step **7**.

To interrupt CD Synchro Recording

- If you press **■** on the CD player to stop the CD, the unit will stop recording and enter recording pause.

Note

Even if the CD player completes playing the CD while the unit is still recording, the unit will continue recording.

Additional information for recording

Dolby Noise Reduction Systems

Dolby NR (Noise Reduction) systems are to reduce background hiss noise on the tape, and applied to all types of cassettes.

This unit is equipped with the Dolby B NR and Dolby C NR systems.

- Dolby B NR is most commonly applied to commercially available stereo cassette tape decks.
- Dolby C NR was further developed from Dolby B NR to satisfy the demand for wider dynamic range sound reproduction, and is more effective in reducing tape noise than Dolby B NR.

It is recommended that a note be made on the cassette label as to which Dolby NR mode the tape was recorded in, since the tape must be played in the same Dolby NR mode.

Dolby HX Pro System

The unit is also equipped with the Dolby HX Pro system.

Dolby HX Pro is a system that constantly adjusts the recording bias current to the most suitable level. With this system, even music sources consisting mostly of high frequency sounds can be recorded in good condition because the dynamic range in higher frequencies can be expanded.

The system operates while recording regardless of the Dolby NR mode setting.

Preventing an accidental recording

- Cassettes have two erasure prevention tabs; one is for side A and the other is for side B as you see in the illustration below. By removing one or both of the tabs, you can prevent accidental recording over the recorded tape.
- After you remove the erasure prevention tabs, you can cover them with adhesive tape for recording. When you do this, avoid covering the tape type detection holes (see "About Automatic Tape Type Detection" on page 10).

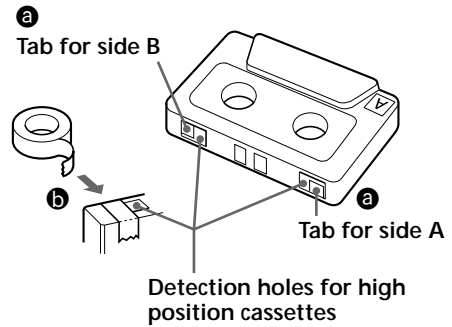

CD dubbing with ONKYO Separate Collection Series

K-505TX (This unit)

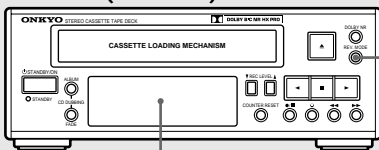

Display

A-905TX (Amplifier)

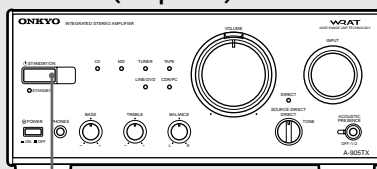

STANDBY/ON

The unit must be connected to A-905TX (Integrated Stereo Amplifier) and C-705TX (CD Player) for these operations. (See "Connecting to the ONKYO Separate Collection Series components" on page 6.)

For CD dubbing, the following two modes are provided:

• ALBUM (Album dubbing)

If a track is not completely recorded because the end of the tape was reached during CD dubbing, the unit will rewind the tape to the beginning of the incompletely recorded track and erase it. If the unit is in the reverse mode (↶), it will continue recording on the other side of the tape starting from the erased track.

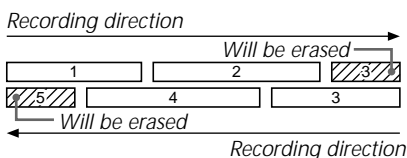

• FADE OUT (Fade out dubbing)

If a track is not completely recorded because the end of the tape was reached during CD dubbing, the unit will fade it out. If the unit is in the reverse mode (↶), it will continue recording on the other side of the tape starting from the beginning of the track that was faded out.

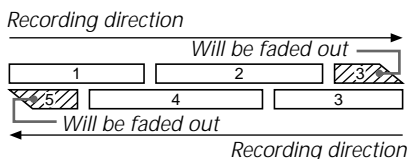

Before starting

The shadowed steps are the operations with the CD player or amplifier.

1 Press STANDBY/ON on the amplifier, if the unit is not turned on.

All the system components will be turned on.



2 Insert a cassette with its erase prevention tabs in place, following step 1 in "Playing a tape" on page 9.

See "Preventing an accidental recording" on page 15.

Be sure to lay the recording side of the cassette face up.

3 Press REV. MODE to select the reverse mode.

Each press changes the indicator in the display; ↶ or ↷.



• When ↶ is lit

The unit records both sides of the tape and stops.

• When ↷ is lit

The unit stops after recording the forwarding side of the tape.

K-505TX (This unit)
REC LEVEL ▼ / ▲

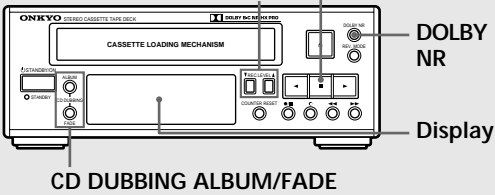

C-705TX (CD player)

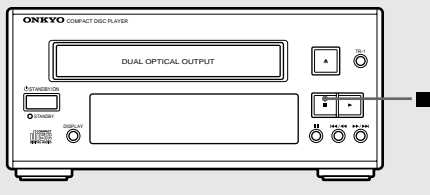

4 Insert a CD into the CD player.

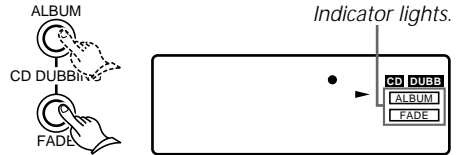
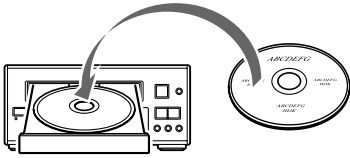

Tip

If you need further fine adjustment to the recording level, use the REC LEVEL ▼ / ▲ buttons (you can adjust the level from -6 to 6).

5 Press DOLBY NR until the Dolby NR mode you want to record with lights in the display.

See "Dolby Noise Reduction Systems" on page 15 for Dolby NR mode information. Each press changes the indicator in the display in the following order:

□□ B (Dolby B NR) → □□ C (Dolby C NR)

↙ The indicator goes off. ↘

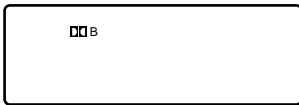

6 Press CD DUBBING ALBUM for Album dubbing or CD DUBBING FADE for Fade out dubbing.

- CD dubbing starts after the unit has completed the following operations:
- The unit rewinds the tape if the tape is not completely rewound to the beginning.
 - The unit adjusts the recording level to its optimum level.

For the dubbing mode, refer to the introduction on the previous page.

Note

If the initial track on the CD is very long and is not completely recorded on one side of the tape, Album dubbing or Fade out dubbing will not operate. If the unit is in the reverse mode (↶), the rest of the CD will be kept recording on the other side of the tape continuously.

To stop CD dubbing

Press ■ on the unit or CD player.

CD dubbing with ONKYO Separate Collection Series (continued)

K-505TX (This unit)

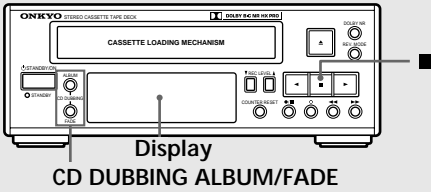

C-705TX (CD player)

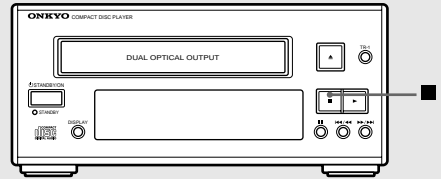

Dubbing from more than two CDs continuously - *Continuous Dubbing*

Before starting

The shadowed steps are operations with the CD player or amplifier.

1 Follow steps 1 to 6 starting from page 16.

2 Press ■ on the unit or CD player, at the point when the track you are dubbing is finished.

CD dubbing stops.



Note

Do not touch any buttons on the unit after CD dubbing stops, otherwise Continuous Dubbing will be cancelled.

3 Replace the CD with the next one.

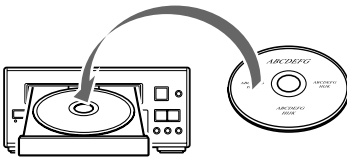

4 Press CD DUBBING ALBUM for Album dubbing or CD DUBBING FADE for Fade out dubbing.

After the insertion of a five-second blank section, the unit starts dubbing the new CD without rewinding the tape.

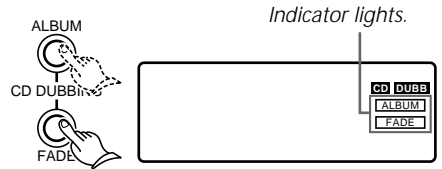

K-505TX (This unit)

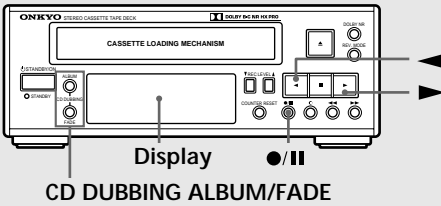

Starting dubbing CD without rewinding the tape

1 Follow steps 1 to 5 starting from page 16.

2 Press and hold ●/||, then press ► or ◀ (to record on the reverse side) to decide the recording direction.

The unit is set to recording pause.

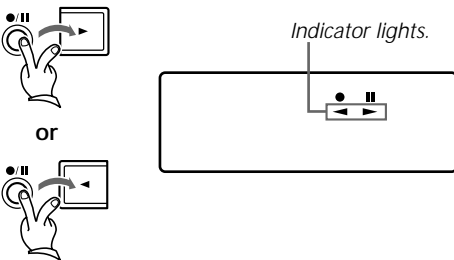

3 Press CD DUBBING ALBUM for Album dubbing or CD DUBBING FADE for Fade out dubbing.

The unit starts dubbing the CD without rewinding the tape.

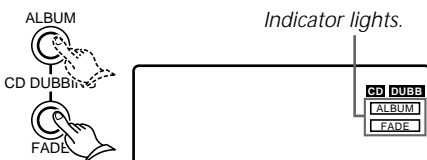

CD/MD Synchro Recording with ONKYO Separate Collection Series

K-505TX (This unit)

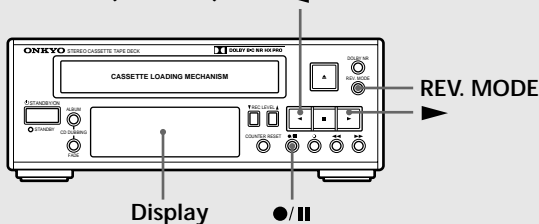

C-705TX (CD player) is used for the illustration example.

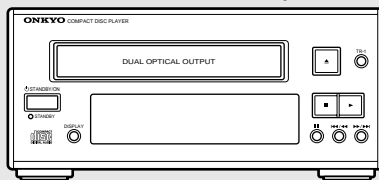

Before starting

The shadowed steps are operations with the CD player or MD recorder, or amplifier.

The unit must be connected to A-905TX (Integrated Stereo Amplifier), and C-705TX (CD Player) or MD-105TX (MD recorder) for these operations. (See "Connecting to the ONKYO Separate Collection Series components" on page 6.)

1 Press **STANDBY/ON** on the amplifier, if the unit is not turned on.

All the system components will be turned on.



2 Insert a cassette with its erasure prevention tabs in place, following step 1 in "Playing a tape" on page 9.

See "Preventing an accidental recording" on page 15.

Note

If you start recording the tape from the beginning, wind the tape slightly forward with a pencil (see page 22 for illustration) before inserting the cassette. This is because the sound cannot be recorded on the leader.

3 Press **REV. MODE** to select the reverse mode.

Each press changes the indicator in the display: ↺ or ↻.

REV. MODE



- *When ↺ is lit*
The unit records both sides of the tape and stops.
- *When ↻ is lit*
The unit stops after recording one side of the tape.

4 Insert a CD into the CD player or insert an MD into the MD recorder, and start playing for recording adjustment.

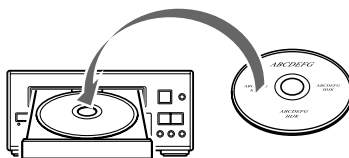

5 Press and hold **●/II**, then press ▶ or ◀ (to record on the reverse side) to decide the recording direction.

The unit is set to recording pause.

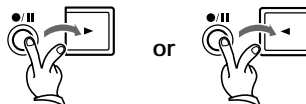

K-505TX (This unit)

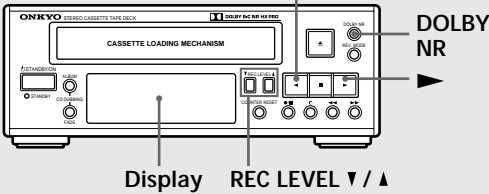

C-705TX (CD player) is used for the illustration example.

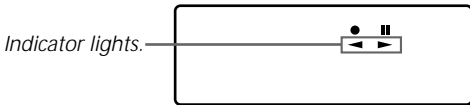
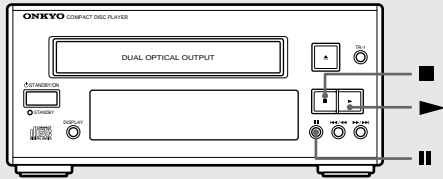

6 Press DOLBY NR until the Dolby NR mode you want to record with lights in the display.

See "Dolby Noise Reduction Systems" on page 15 for Dolby NR mode information. Each press changes the indicator in the display in the following order:

□□ B (Dolby B NR) → □□ C (Dolby C NR)

↑ The indicator goes off. ↙



7 Press REC LEVEL ▼ / ▲ to adjust the recording levels (0 to 50).

The recording level indication appears in the display instead of the digital counter. The level between 14 and 24 should suit most recording cases.

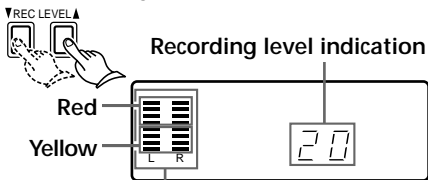

Incoming signal level indicator

- **When using NORMAL (TYPE I) or HIGH (TYPE II) type cassette**

Check the incoming signal level indicator. The bottom red bar should light constantly, and the second red bar from the bottom should light occasionally.

- **When using METAL TAPE (TYPE IV) cassette**

Check the incoming signal level indicator. The second red bar from the bottom should light constantly, and the third red bar from the bottom should light occasionally.

Note

If you do not set the proper recording level for the tape type, the sound may be distorted.

8 Set the CD player or MD recorder to start playing at the point you want to start recording from.

9 Press ► on the CD player or MD recorder.

CD or MD recording starts.



Note

Even if CD playback is stopped before dubbing is complete, the unit continues recording.

To stop recording

Press ■ on the unit. (The CD player or MD recorder continues playing.)

To interrupt synchro dubbing

Press || or ■ on the CD player or MD recorder.

The unit enters recording pause.

To continue recording, press ► or ◀ on the unit (the button indicated in the display).

If the tape is loose and hanging out of the cassette

If you try to play the cassette when the tape is loose and hanging out, the tape won't be picked up properly between the capstan and the pinch roller and may be jammed inside, this will result in damage to the tape. Tighten the loose tape as shown in the illustration below.

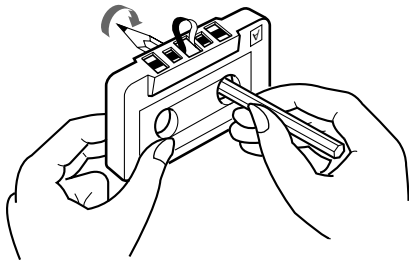

Caution

- Do not touch the tape surface.
- Do not put thick paper or cardboard labels in the cassette holder.
- Do not put cassettes near magnetic sources like speakers, amplifiers, TVs, etc. Your important recording might be erased or damaged.
- Do not expose cassettes to direct sunlight.

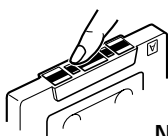

NO!

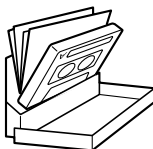

NO!

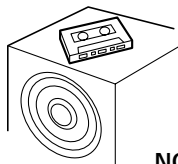

NO!



NO!

Cassettes not recommended

- **C120 cassettes**
C120 tape is thin and therefore more liable to break. There is a possibility that tape could get caught in the pinch roller or capstan.
- **Continuous loop (endless) tapes**
Do not use continuous loop (endless) tapes.

Cleaning the tape heads

Clean the (recording/playback/erasure) heads, capstan, and pinch roller before recording/playing in order to enjoy the best sound. Normally clean it at least after every ten hours of use.

Use a commercially available wet-type head cleaning cassette.

Refer to the operation manual of the head cleaning cassette for details.

Caution

- Turn the amplifier volume down to the minimum before cleaning.
- Do not use any dry-type head cleaning cassette.
- Wait a few minutes after cleaning until the heads are completely dried before inserting a cassette.

De-magnetizing the tape heads

When the cassette deck is used for a long time, magnetism will build up on the head. This causes noise or a loss of high sound range on important recorded tapes. De-magnetize the head after every 50 hours of use with a commercial de-magnetizer suited to this cassette deck. Refer to the operation manual of the de-magnetizer for details.

Caution

Turn the amplifier volume down to the minimum before de-magnetizing.



Troubleshooting

If you have any problems with the unit, please check the troubleshooting table below first. For any problems not covered in the table, please consult your nearest ONKYO authorized service center.

Symptom	Cause	Remedy
The unit doesn't turn on.	<ul style="list-style-type: none"> The AC power cord is not inserted in the wall outlet securely. The R-805TX ENERGY SAVE function is activated. (If connected to the R-805TX) 	<ul style="list-style-type: none"> Insert the AC power cord (mains lead) plug into the wall outlet (the mains) securely. Please push the R-805TX STANDBY/ON button. The power in the main unit will be turned on.
No sound is heard even when playback starts.	<ul style="list-style-type: none"> Hookups are incorrect. The stereo amplifier's input selector is set to the wrong position. 	<ul style="list-style-type: none"> Check the hookup and connect the unit correctly (see page 7). Set the amplifier's input selector to the position the unit is connected to.
Tape transport doesn't operate.	A slack tape is wound around the pinch roller.	Tighten the tape with a pencil (see previous page).
The REC button doesn't operate.	<ul style="list-style-type: none"> No cassette is inserted in the unit. One or both of the erasure prevention tabs have been removed. 	<ul style="list-style-type: none"> Insert a cassette (see page 9). Use a new cassette or cover the erasure prevention tabs with adhesive tape (see page 15).
Sound is hoarse, or the left and right sounds are unbalanced.	<ul style="list-style-type: none"> The playback head is dirty. The tape is stretched. 	<ul style="list-style-type: none"> Clean the tape head (see previous page). Use a new cassette.
Excessive tape hiss or noise is heard.	<ul style="list-style-type: none"> The playback head is magnetized. The tape is worn out or recorded with high noise level. 	<ul style="list-style-type: none"> Demagnetize the head (see previous page). Use a new cassette.
Sound is distorted.	The tape is worn out, or distorted sound is recorded.	Use a new tape. (Play another tape to make sure the cause is not malfunction of the unit.)
Recorded sounds are distorted.	The tape was recorded with too high a recording level.	Adjust the recording level (see page 13) before you start recording.
The tape squeals or skips the sound.	<ul style="list-style-type: none"> The heads, pinch rollers, or capstan shafts are dirty. The cassette shell is binding the tape or the tape is stretched. 	<ul style="list-style-type: none"> Clean the tape head (see previous page). Try to release the bound tape by fast-forwarding and rewinding. If the tape is damaged, use a new cassette.
Excessive hum is heard while playing a tape.	<ul style="list-style-type: none"> The audio cables are not inserted firmly. External flux leakage from an amplifier or TV set is affecting to the sound. 	<ul style="list-style-type: none"> Insert the cable plugs firmly. Put more distance between the unit and appliance affecting to the unit.

(Continued on the next page)

Troubleshooting (continued)

Symptom	Cause	Remedy
High frequencies are too strong.	<ul style="list-style-type: none"> The Dolby NR mode setting is not matched to the one the tape was recorded with. Automatic tape-type detection is not operating properly. 	<ul style="list-style-type: none"> Set the proper Dolby NR mode (see pages 9 and 15) before you start playing the tape. Check the detection holes are not covered, and that you are using a cassette which meets the tape standard (see page 10).
No high frequency sounds are heard.	<ul style="list-style-type: none"> The Dolby NR mode setting is not matched to the one the tape was recorded with. The tape head is dirty. 	<ul style="list-style-type: none"> Set the proper Dolby NR mode (see pages 9 and 15) before you start playing the tape. Clean the tape head (see page 22).
The skip function doesn't operate properly.	The blank section between tracks is too short or noisy.	Insert the blank section properly (see page 14).
Auto Reverse doesn't operate properly.	<ul style="list-style-type: none"> The reverse mode is not set to . The cassette has no leader or the leader is not transparent. 	<ul style="list-style-type: none"> Set the reverse mode to  (see page 9). Use a cassette with suitable leader.
Auto Reverse operates even though the tape has not reached the end.	The tape is creased, wrinkled, or scratched.	<ul style="list-style-type: none"> Use a new cassette. Set the one-way playback mode () (see page 9).
The unit doesn't operate properly.	The internal microcomputer of the unit is being affected by the power supply or static electricity.	<p>Turn off the unit for more than ten seconds, and turn it on again.</p> <p>If the unit still remains inoperable, disconnect the AC power cord (mains lead) from the wall outlet (the mains) and connect it again.</p>

Specifications

Track format

4-tracks, 2-channels

Erasing system

AC erase

Tape speed

4.8 cm/sec.

Wow and flutter

0.1 % (WRMS)

0.2 % (DIN)

Frequency response

Metal position tape

30 to 15,000 Hz \pm 3 dB

High position tape

30 to 14,000 Hz \pm 3 dB

Normal position tape

30 to 13,000 Hz \pm 3 dB

Signal to noise ratio

- 54 dB (metal position tape, Dolby NR off)
- Noise reduction of 10 dB above 5 kHz and 5 dB at 1 kHz is possible with Dolby B NR.
- Noise reduction of 20 dB at 5 kHz is possible with Dolby C NR.

Input Jacks

LINE IN: 2

Input sensitivity: 80 mV

Input impedance: 50 kohms

Output Jacks

LINE OUT: 2

Standard output level: 500 mV

Output load impedance:
over 50 kohms

Motors

DC servo motor: 1

Heads

REC/PB: Special Hard Permalloy: 1

Erase head: Ferrite: 1

Power supply rating

AC 230-240 V, 50 Hz

AC 120 V, 60 Hz

Power consumption

12 W (230-240 V, 50 Hz)

14 W (120 V, 60 Hz)

Dimensions

205 mm \times 76 mm \times 278 mm

(Width \times Height \times Depth)

Weight

2.6 kg

Specifications and external appearance are subject to change without notice as a result of product improvement.

Index to parts and controls

For operational instructions, refer to the page indicated in square parentheses.

Front panel

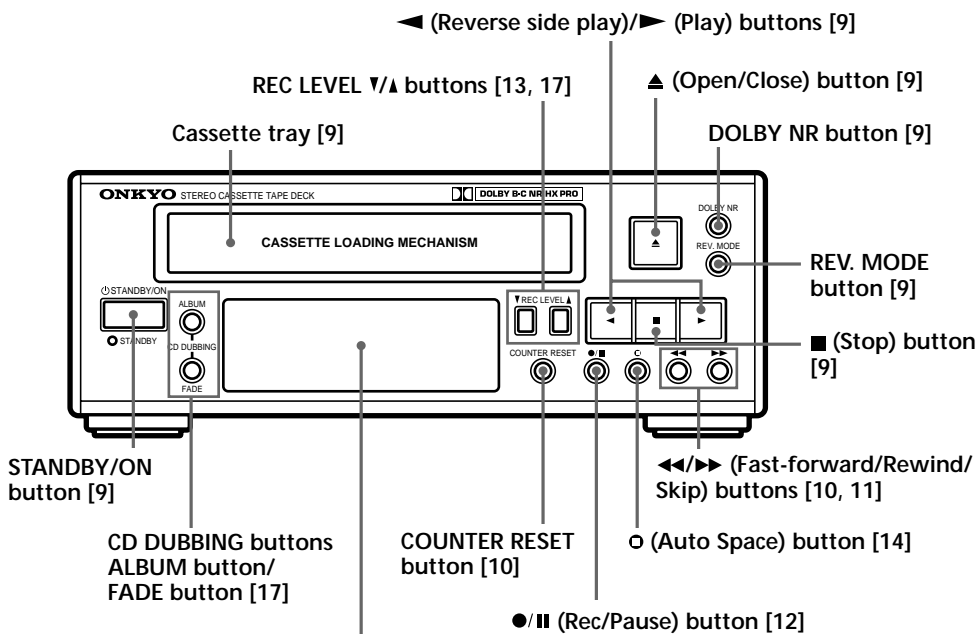

Display

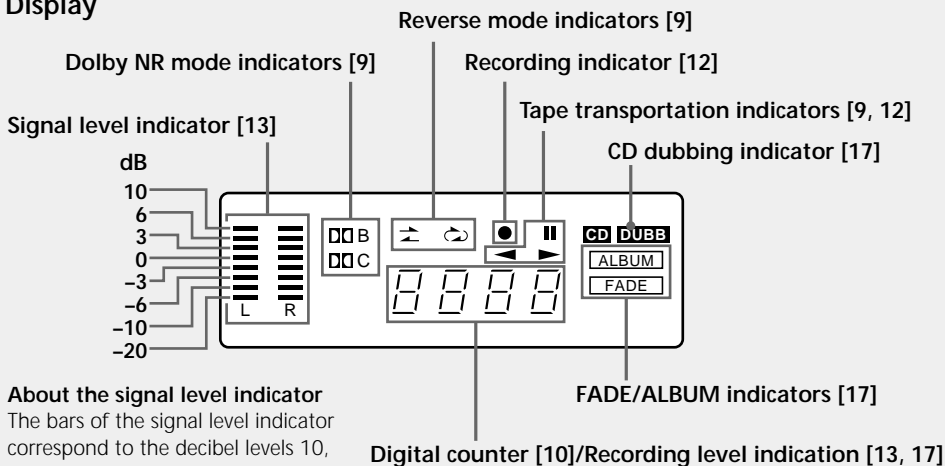

About the signal level indicator

The bars of the signal level indicator correspond to the decibel levels 10, 6, 3, 0, -3, -6, -10, and -20 from the top as indicated in the display illustration.

Remote controller supplied with the A-905TX or R-805TX (RC-456S).

To operate the supplied remote controller, make the appropriate connection to the **RI** remote connectors.

Remote controller

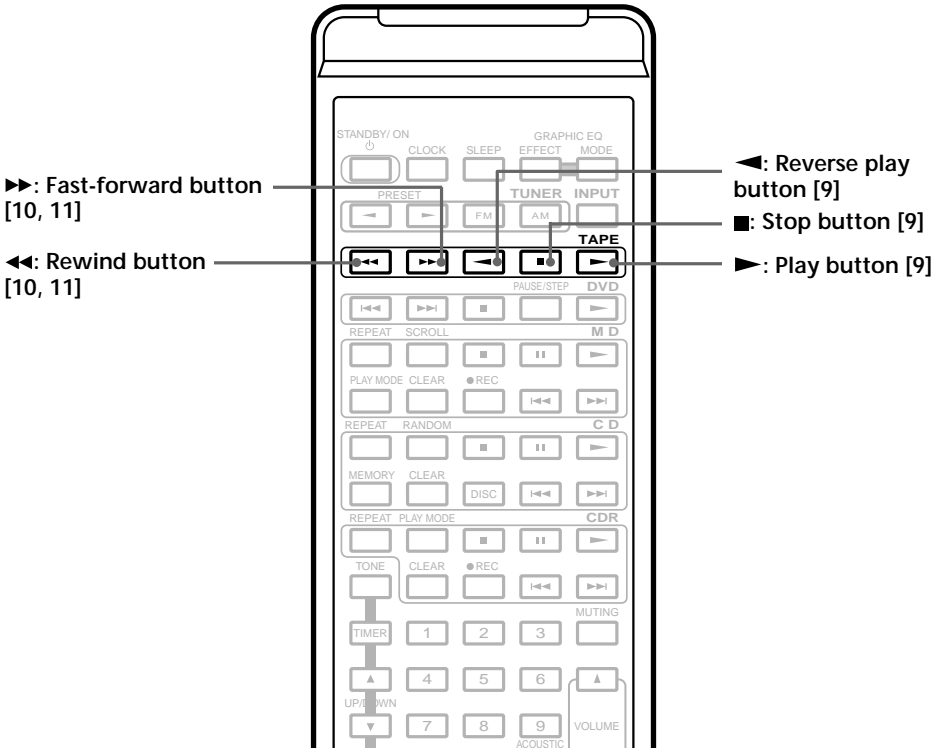

ONKYO CORPORATION

Sales & Product Planning Div. : 2-1, Nisshin-cho, Neyagawa-shi, OSAKA 572-8540, JAPAN
Tel: 072-831-8111 Fax: 072-833-5222

ONKYO U.S.A. CORPORATION

18 Park Way, Upper Saddle River, N.J. 07458, U.S.A.
Tel: 201-785-2600 Fax: 201-785-2650 E-mail: onkyo@onkyousa.com

ONKYO EUROPE ELECTRONICS GmbH

Industriestrasse 20, 82110 Germering, GERMANY
Tel: 089-849-320 Fax: 089-849-3265 E-mail: info@onkyo.de

ONKYO CHINA LIMITED

Units 2102-2107, Metroplaza Tower I, 223 Hing Fong Road, Kwai Chung,
N.T., HONG KONG Tel: 852-2429-3118 Fax: 852-2428-9039

SN 29343076



Printed in Japan
T0103-1

