

Docking Entertainment System

DC910

Register your product and get support at
www.philips.com/welcome

User manual



PHILIPS

Important notes for users in the U.K.

Mains plug

This apparatus is fitted with an approved 13 Amp plug. To change a fuse in this type of plug proceed as follows:

- 1 Remove fuse cover and fuse.
- 2 Fix new fuse which should be a BS1362 3 Amp, A.S.T.A. or BSI approved type.
- 3 Refit the fuse cover:

If the fitted plug is not suitable for your socket outlets, it should be cut off and an appropriate plug fitted in its place.

If the mains plug contains a fuse, this should have a value of 3 Amp. If a plug without a fuse is used, the fuse at the distribution board should not be greater than 3 Amp.

Note: The severed plug must be disposed of to avoid a possible shock hazard should it be inserted into a 13 Amp socket elsewhere.

How to connect a plug

The wires in the mains lead are coloured with the following code: blue = neutral (N), brown = live (L).

- As these colours may not correspond with the colour markings identifying the terminals in your plug, proceed as follows:
 - Connect the blue wire to the terminal marked N or coloured black.
 - Connect the brown wire to the terminal marked L or coloured red.
 - Do not connect either wire to the earth terminal in the plug, marked E (or \perp) or coloured green (or green and yellow).

Before replacing the plug cover, make certain that the cord grip is clamped over the sheath of the lead - not simply over the two wires.

Copyright in the U.K.

Recording and playback of material may require consent. See Copyright Act 1956 and The Performer's Protection Acts 1958 to 1972.

CAUTION

Use of controls or adjustments or performance of procedures other than herein may result in hazardous radiation exposure or other unsafe operation.

General Information

Supplied accessories	4
Environmental information	4
Safety Information	4~5
Hearing Safety	5

Preparations

Connections	6~7
Power	
Antenna connection	
Optional connection	
Mounting the set onto wall	7
Using Remote Control	7

Controls

Controls on the system	8
Controls on the remote control	9

Basic Functions

Switching the system on	10
Switching the system to standby mode	10
Switching the system to Eco Power Standby mode	10
Power Saving Automatic Standby	10
Adjusting volume and sound	10

Radio Reception

Tuning to radio stations	11
Programming radio stations	11
Automatic programming	
Manual programming	
Tuning to preset radio stations	11

USB/Card

Using a USB mass storage device/SD/MMC memory card	12~13
Using playback features	13~14
Basic playback controls	
Different play modes: SHUFFLE and REPEAT	
Programming audio files	

Dock for iPod

Playing Apple iPod using DC910	15
Compatible iPod player	
Dock adaptor	
Playing Apple iPod	
Charging iPod battery using the dock	15

AUX

Listening to an external source	16
---------------------------------------	----

Clock/Timer

Clock setting	17
Timer setting	17
Sleep timer setting	18

Specifications

Maintenance

Troubleshooting

General Information

Congratulations on your purchase and welcome to Philips!

To fully benefit from the support that Philips offers, register your product at www.philips.com/welcome.

This product complies with the radio interference requirements of the European Community.

Supplied accessories

- remote control with 1 CR2025 battery
- 3 X iPod dock adaptors
- 1 X certified AC/DC adapter
(Input: 100- 240V~, 50/60Hz 1.4 A, Output: 24V  2.5A; manufacturer: Philips; model No.: GFP651DA-2425/OH-1065A2402500U)
- 1 x AUX cable
- Mounting kit (2 dowels and 2 screws)

Environmental information

All unnecessary packaging has been omitted. We have tried to make the packaging easy to separate into three materials: cardboard (box), polystyrene foam (buffer) and polyethylene (bags, protective foam sheet).

Your system consists of materials which can be recycled and reused if disassembled by a specialised company. Please observe the local regulations regarding the disposal of packaging materials, exhausted batteries and old equipment.

Disposal of your old product

Your product is designed and manufactured with high quality materials and components, which can be recycled and reused.

When this crossed-out wheeled bin symbol is attached to a product it means the product is covered by the European Directive 2002/96/EC

Please inform yourself about the local separate collection system for electrical and electronic products.



Please act according to your local rules and do not dispose of your old products with your normal household waste. The correct disposal of your old product will help prevent potential negative consequences for the environment and human health.

Safety Information

- Before operating the system, check that the operating voltage indicated on the typeplate of your system is identical with the voltage of your local power supply. If not, please consult your dealer.
- Where the MAINS plug or an appliance coupler is used as the disconnection device, the disconnection device shall remain readily operable.
- Place the system on a flat, hard and stable surface.
- Place the system in a location with adequate ventilation to prevent internal heat build-up in your system. Allow at least 10 cm (4 inches) clearance from the rear and the top of the unit and 5 cm (2 inches) from each side.
- The ventilation should not be impeded by covering the ventilation openings with items, such as newspapers, table-cloths, curtains, etc.
- Do not expose the system, batteries or discs to excessive moisture, rain, sand or heat sources caused by heating equipment or direct sunlight.
- No naked flame sources, such as lighted candles, should be placed on the apparatus.
- No objects filled with liquids, such as vases, shall be placed on the apparatus.
- Install this unit near the AC outlet and where the AC power plug can be reached easily.
- The apparatus shall not be exposed to dripping or splashing.
- Excessive sound pressure from earphones and headphones can cause hearing loss.
- Battery shall not be exposed to excessive heat such as sunshine, fire or the like.
- If the system is brought directly from a cold to a warm location, or is placed in a very damp room, moisture may condense on the lens of the disc unit inside the system. Should this occur, the CD player would not operate normally. Leave the power on for about one hour with no disc in the system until normal playback is possible.

- The mechanical parts of the set contain self-lubricating bearings and must not be oiled or lubricated.
- Batteries (battery pack or batteries installed) shall not be exposed to excessive heat such as sunshine, fire or the like.
- **When the system is switched to Standby mode, it is still consuming some power.**
To disconnect the system from the power supply completely, remove the AC power plug from the wall socket.

Hearing Safety

Listen at a moderate volume.

- Using headphones at a high volume can impair your hearing. This product can produce sounds in decibel ranges that may cause hearing loss for a normal person, even for exposure less than a minute. The higher decibel ranges are offered for those that may have already experienced some hearing loss.
- Sound can be deceiving. Over time your hearing "comfort level" adapts to higher volumes of sound. So after prolonged listening, what sounds "normal" can actually be loud and harmful to your hearing. To guard against this, set your volume to a safe level before your hearing adapts and leave it there.

To establish a safe volume level:

- Set your volume control at a low setting.
- Slowly increase the sound until you can hear it comfortably and clearly, without distortion.

Listen for reasonable periods of time:

- Prolonged exposure to sound, even at normally "safe" levels, can also cause hearing loss.
- Be sure to use your equipment reasonably and take appropriate breaks.

Be sure to observe the following guidelines when using your headphones.

- Listen at reasonable volumes for reasonable periods of time.
- Be careful not to adjust the volume as your hearing adapts.
- Do not turn up the volume so high that you can't hear what's around you.
- You should use caution or temporarily discontinue use in potentially hazardous situations.
- Do not use headphones while operating a motorized vehicle, cycling, skateboarding, etc.; it may create a traffic hazard and is illegal in many areas.

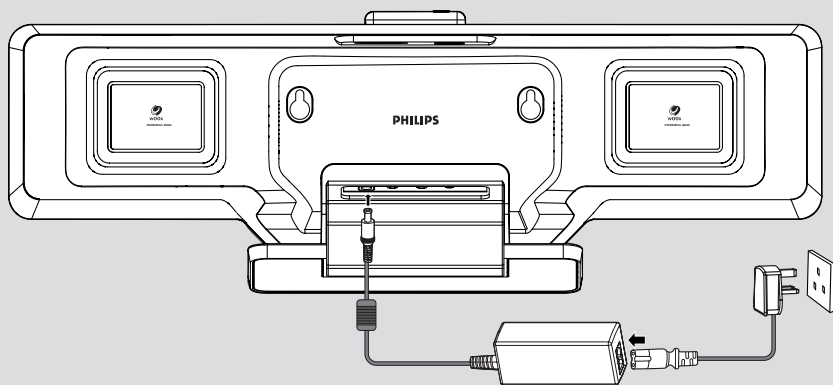

Connections

The type plate is located at the bottom of the system.

For users in the U.K.: please follow the instructions on page 2.

A Power

- Before connecting the AC power adaptor to the wall outlet, ensure that all other connections have been made.
- DC jack is located at the bottom panel of the set.

WARNING!

- **Use the supplied AC power adaptor only! Using any other power connection device may damage your main set!**
- **For optimal performance, use only the original AC power adaptor.**
- **Never make or change connections with the power switched on.**

To avoid overheating of the system, a safety circuit has been built in. Therefore, your system may switch to Standby mode automatically under extreme conditions. If this happens, let the system cool down before reusing it (not available for all versions).

B Antenna Connection

FM Antenna

It is unnecessary to connect the FM pigtail antenna since it is fixed to the main unit.

- Adjust the FM antenna for optimal FM stereo reception.

C Optional connection

The optional equipment and connecting cords are not supplied. Refer to the operating instructions of the connected equipment for details.

Connecting a USB mass storage device or SD/MMC memory card

By connecting a USB mass storage device or SD/MMC memory card to the Hi-Fi system, you can enjoy the device's or card's stored music through the powerful speakers of the Hi-Fi system.

- Insert the USB device's USB plug into the  socket on the set.

OR

for the devices with USB cables:

- 1 Insert one plug of the USB cable (not supplied) to the  socket on the set.
- 2 Insert the other plug of the USB cable to the USB output terminal of the USB device.

OR

for the memory card:

- Fully insert the memory card (metal contact facing left) into the **SD / MMC** slot on the top of the system.

Connecting other equipment to your system

This feature allows you to listen to music from the external equipment through the powerful speakers of the Hi-Fi system.

- Use an Aux-in cable (supplied) to connect the AUX IN-1 or AUX-2 jack (3.5mm, located on the bottom panel) to an AUDIO OUT or headphone jack on an external device (such as TV, Laser Disc player, DVD player or CD recorder).

Note:

- Refer to the operating instructions for the connected equipment for details.

Mounting the set onto wall

See the separate sheet of Wall Mounting instructions on how to mount the set onto wall.

Note:

- To secure the mounting on wall, cement wall is required.

Using Remote Control

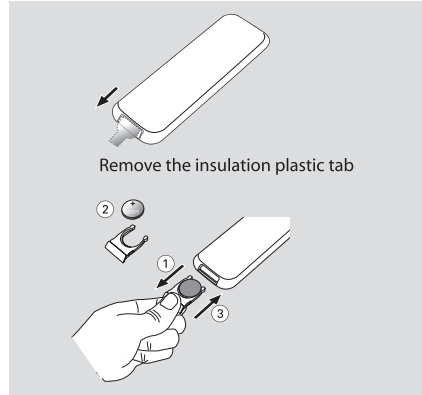

IMPORTANT!

- Before using the remote control, remove the insulation plastic tab as shown in the picture below.
- If the remote control does not function correctly or the operating range is reduced, replace the battery with a new (CR2025) battery.



- 1 Push to open the battery tray.
- 2 Replace a new battery according to the indicated polarity.
- 3 Push the battery tray back to close it.

Using the Remote Control to operate the Player

- 1 Aim the Remote Control directly at the remote sensor (IR) on the front panel.
- 2 Select the source you wish to control by pressing one of the source select buttons on the remote.
- 3 Then select the desired function (for example, ,  or .

CAUTION!

- Remove the battery if it is exhausted or if the Remote Control is not being used for a long time.
- Batteries contain chemical substances, so they should be disposed of properly.

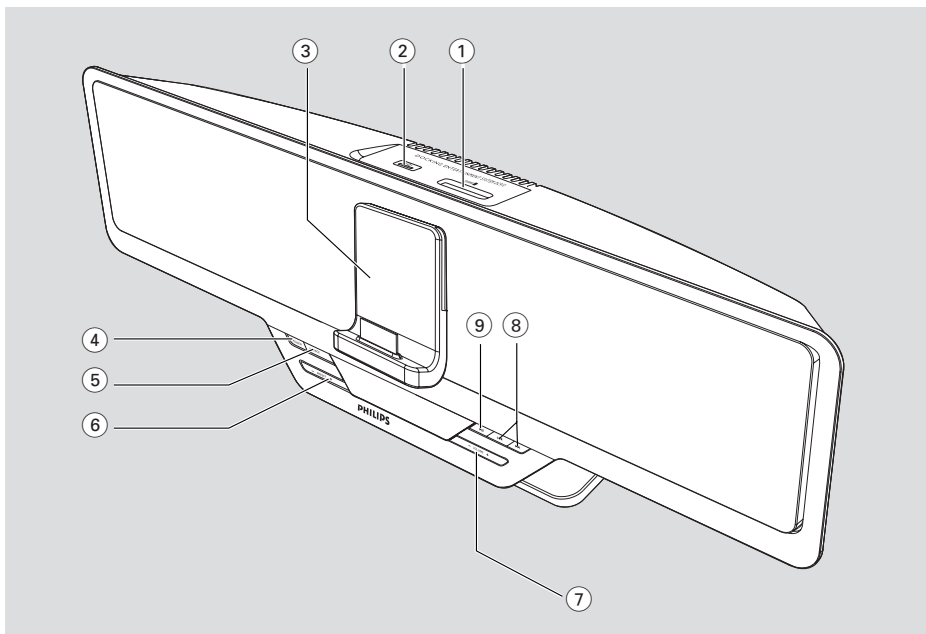

Controls on the system

① SD / MMC

- is the slot used to insert an SD/MMC memory card.

② USB port

- jack for the external USB mass storage device.

③ iPod dock

- is used to dock your iPod player for playback or recharging through this system.

④ POWER

- switches the system on or to Eco Power standby/normal standby with clock display.

⑤ SOURCE

- selects the respective sound source for TUNER (FM)/iPod/USB/CARD (SD/MMC)/AUX.

⑥ PRESET +/-

- (for USB/CARD) skips to the beginning of a current/previous/subsequent album.
- selects a preset radio station.

DBB (Dynamic Bass Boost)

- enables or disables bass enhancement. (in USB/Tuner mode, hold down then release to select)

DSC (Digital Sound Control)

- selects different types of preset sound equalizer settings. (in USB/Tuner mode, hold down then release to select)

⑦ VOLUME +/-

- adjusts the volume level.
- adjusts the hours and minutes for the clock/timer function.
- switches between 12 hour and 24 hour display.

⑧

for USB/CARD/iPod

- fast searches back and forward within a track (press and hold).
- skips to the beginning of a current/previous/subsequent track.

for TUNER tunes to radio stations (down/up).

⑨

- starts or interrupts playback.

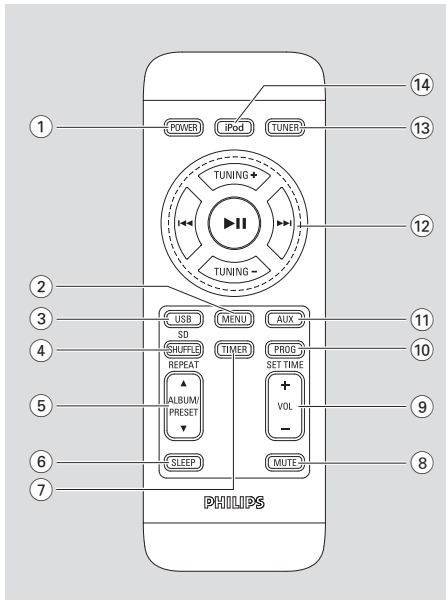

Controls on the remote control

- ① POWER**
 - switches the system on or to Eco Power standby/normal standby with clock display.
- ② MENU**
 - is equivalent to the MENU button on your iPod player.
- ③ USB/SD**
 - switches between USB and SD mode.
- ④ SHUFFLE/REPEAT**
 - for USB/CARD
 - plays USB/CARD tracks randomly.
 - selects a repeat playback mode.
- ⑤ ALBUM/PRESET ▲ / ▼**
 - (for USB/CARD) skips to the beginning of a current/previous/subsequent album.
 - selects a preset radio station.
- ⑥ SLEEP**
 - selects the sleeper time.
- ⑦ TIMER**
 - sets the timer function.
- ⑧ MUTE**
 - interrupts and resumes sound production.

- ⑨ VOL + / -**
 - adjusts the volume level.
 - adjusts the hours and minutes for the clock/timer function.
 - switches between 12 hour and 24 hour display.
- ⑩ PROG/SET TIME**
 - (for USB/CARD) programs tracks.
 - (for TUNER) programs radio stations.
 - sets the clock function.
- ⑪ AUX**
 - selects AUX mode.
- ⑫ ► ||**
 - starts or interrupts playback.
 - confirms a selection (for iPod menu operation only).

TUNING + / -

for TUNER tunes to radio stations (down/up).
 navigates the iPod menu.



for USB/CARD/iPod

..... fast searches back and forward within a track (press and hold).
 skips to the beginning of a current/previous/subsequent track.

- ⑬ TUNER**
 - selects the tuner source
- ⑭ iPod**
 - selects the iPod source.

Notes for remote control:

- First select the source you wish to control by pressing one of the source select keys on the remote control (for example iPod, TUNER).
- Then select the desired function (for example ► ||, <<<, >>>).

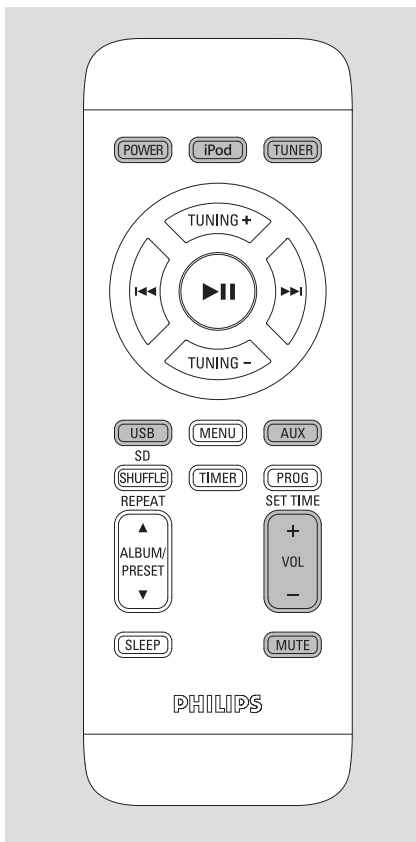

IMPORTANT:

Before you operate the system, complete the preparation procedures.

Switching the system on

- Press **POWER**.
→ The system will switch to the last selected source.
- Press **SOURCE** on the set or **iPod, TUNER, USB/CARD** or **AUX** on the remote control.
→ The system will switch to the selected source.

Switching the system to standby mode

- Press **POWER**.
→ The backlight for clock display is off in standby.

→ The display displays clock time, or ---: --- is displayed if clock time is not set.

→ The volume level (up to a maximum volume level of 12), interactive sound settings, last selected mode (ECO Power Standby or normal standby), source and tuner presets will be retained in the player's memory.

Switching the system to Eco Power Standby mode

- Press and hold **POWER** for more than 2 seconds.
→ The backlight will go blank.

Power Saving Automatic Standby

As a power-saving feature, the system automatically switches to Eco Power/ Standby 15 minutes after playback has reached the end and no control is operated.

Adjusting volume and sound

- 1 Press **VOLUME +/-** on the system (or **VOL +/-** on the remote control) to decrease or increase the volume.
→ Display shows the volume level VOL and a number from 0, 1, 2, ...32.
- 2 In USB/Tuner mode, press and hold **DSC** on the set, then release to select a sound effect: **ROCK/POP/JAZZ/CLASSIC**.
- In iPod /AUX mode, simply press **DSC** on the set to select the desired sound effect.
- 3 In USB/Tuner mode, press and hold **DBB** on the set, then release to switch bass enhancement on or off.
- In iPod /AUX mode, simply press **DBB** on the set to switch bass enhancement on or off.
→ If the DBB is activated, **DBB ON** is shown.
→ If the DBB is deactivated, **DBB OFF** is shown.
- 4 Press **MUTE** on the remote control to interrupt sound reproduction instantly.
→ Playback will continue without sound and **MUTE** will flash on the display.
- To activate sound reproduction you can:
 - press **MUTE** on the remote control again;
 - adjust the volume controls;
 - change source.

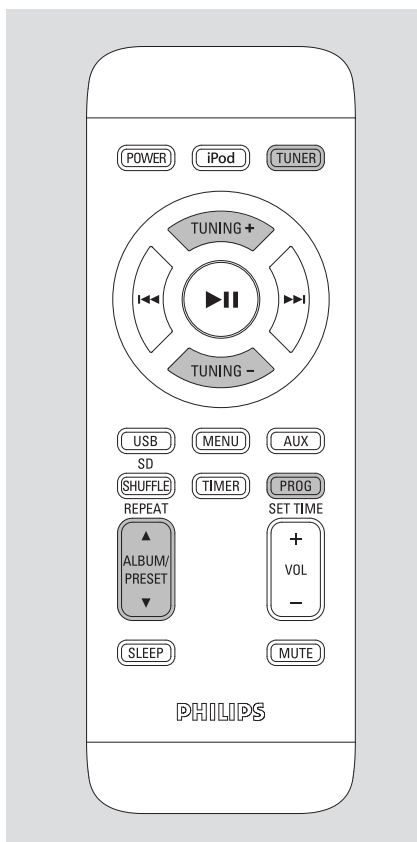

Tuning to radio stations

- 1 Press **SOURCE** repeatedly (or **TUNER** on the remote control) to select the tuner source (FM).
- 2 Hold **◀◀/▶▶** on the system (or **TUNING +/-** on the remote control) and then release the button.
→ The system will start searching for a radio station with sufficient signal strength.
- 3 Repeat step 2 if necessary until you find the desired station.
- To tune to a weak station, press **◀◀/▶▶** on the system (or **TUNING +/-** on the remote control) briefly and repeatedly until you have found optimal reception.

Programming radio stations

You can store up to a total of 40 radio stations (40 FM) in the memory.

Automatic programming

Autostore automatically starts programming radio stations from preset 1. Any previous presets e.g. manually programmed will be erased.

- Press **PROG** on the remote control for more than two seconds to activate programming.
→ All available stations are programmed.

Manual programming

- 1 Tune to your desired station (refer to "Tuning to radio stations").
- 2 Press **PROG** on the remote control to activate programming.
→ **PROG** appears in the display.
- 3 Press **PRESET +/-** on the system (or **ALBUM/PRESET ▲/▼** on the remote control) to allocate a number from 1 to 40 to this station.
- 4 Press **PROG** on the remote control again to confirm the setting.
→ **PROG** disappears, the preset number and the frequency of the preset station are shown.
- 5 Repeat the above four steps to store other stations.
- You can override a preset station by storing another frequency in its place.

Tuning to preset radio stations

- Press **PRESET +/-** on the system (or **ALBUM/PRESET ▲/▼** on the remote control) until the desired preset station is displayed.

Using a USB mass storage device/SD/MMC memory card

By connecting a USB mass storage device or SD/MMC memory card to the Hi-Fi system, you can enjoy the device's or card's stored music through the powerful speakers of Hi-Fi system.

Playing a USB mass storage device/SD/MMC memory card

Compatible mass storage devices/cards

With the Hi-Fi system, you can use:

- USB flash memory (USB 2.0 or USB1.1)
- USB flash players (USB 2.0 or USB1.1)
- SD/MMC memory cards

Notes:

– *In some USB flash players (or memory devices), the stored contents are recorded using copyright protection technology. Such protected contents will be unplayable on any other devices (such as this Hi-Fi system).*

– *Compatibility of the USB connection on this product:*

a) *This product supports most USB Mass storage devices (MSD) that are compliant to the USB MSD standards.*

i) *Most common Mass storage class devices are flash drives, memory sticks, jump drives and etc.*

ii) *If you see a "Disc Drive" show up on your computer after you plugged the mass storage device into your computer, most likely it is MSD compliant and it will work with this product.*

b) *If your Mass storage device required a battery/power source. Please make sure you have a fresh battery in it or charge the USB device first and then plug it into the product again.*

– *Supported Music type:*

a) *This device only supports unprotected music with the following file extension:*

.mp3

.wma

b) *Music bought from on-line music stores are not supported because they are secured by Digital Rights Management protection (DRM).*

c) *File name extensions that end with the following are not supported:*

.wav; .m4a; .m4p; mp4; .aac and etc.

– *No Direct connection can be made from Computer USB port to the product even you have either or both mp3 or wma files in your computer.*

Supported formats:

- USB or memory file format FAT12, FAT16, FAT32 (sector size: 512 bytes)
- MP3 bit rate (data rate): 32-320 Kbps and variable bit rate
- WMA v9 or earlier
- Directory nesting up to a maximum of 8 levels
- Number of albums/ folders: maximum 99
- Number of tracks/titles: maximum 400
- ID3 tag v2.0 or later
- File name in Unicode UTF8 (maximum length: 128 bytes)

The system will not play or support the following:

- Empty albums: an empty album is an album that does not contain MP3/WMA files, and will not be shown in the display.
- Non-supported file formats are skipped. This means that e.g.: Word documents .doc or MP3 files with extension .dlf are ignored and will not be played.
- AAC, WAV, PCM audio files
- DRM protected WMA files
- WMA files in Lossless format

How to transfer music files from PC to a USB mass storage device/SD/MMC memory card

By dragging and dropping music files, you can easily transfer your favorite music from PC to a USB mass storage device/SD/MMC memory card.

For a flash player, you can also use its music management software for the music transfer.

However, those WMA files may be unplayable for compatibility reasons.

How to organize your MP3/WMA files on the USB mass storage device/SD/MMC memory card

This Hi-Fi system will browse the MP3/WMA files in the folders/sub-folders/titles order.
Example:

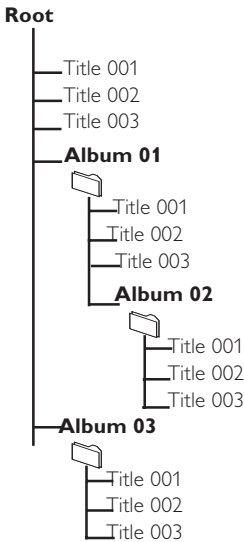

Organize your MP3/WMA files in different folders or subfolders as required.

Notes:

- If you have not organized MP3/WMA files into any albums on your disc, an album "01" will be automatically assigned for all those files.
- Make sure that the file names of MP3 files end with .mp3. and the file names of WMA files end with .wma.

– For DRM protected WMA files, use Windows Media Player 10 (or later) for conversion. Visit www.microsoft.com for details about Windows Media Player and WM DRM (Windows Media Digital Rights Management).

- 1 Check the USB device/SD/MMC memory card has been properly connected. (See "Preparations: Connecting a USB mass storage device or SD/MMC memory card").
- 2 Press **SOURCE** on the system (**USB/CARD** on the remote) once or more to select USB/CARD.
→ **NO AUDIO** appears if no audio file is found in the USB device/SD/MMC memory card.
- 3 Play the available audio files using playback buttons on the set or remote control (such as **▶||**, **◀◀/▶▶**).

Using playback features

Basic playback controls

To play audio file

- Press **▶ ||** to start playback.

To interrupt playback

- Press **▶||** during playback.
→ To resume, press **▶||** again.

To select a different track

- Press **◀◀/▶▶** once or repeatedly until the desired track number appears in the display.
- For MP3/WMA, you may press **PRESET +/-** on the system (or **ALBUM/PRESET ▲/▼** on the remote control) to select a desired album, then select your desired track.

To find a passage within a track

- Press and hold down on **◀◀/▶▶**.
→ The file is played at high speed and low volume.

Different play modes: SHUFFLE and REPEAT

You can select and change the various play modes before or during playback. The REPEAT modes can also be combined with PROGRAMME.

SHUFall the audio files are played in random order

REP ALLrepeats all the audio files/ programme

REPplays the current audio file continuously

- 1 To select your play mode, press **SHUFFLE/ REPEAT** on the remote control before or during playback until the display shows the desired function.
- 2 Press **▶II** to start playback if in the STOP position.
- 3 To return to normal playback, press **SHUFFLE/ REPEAT** on the remote control until the various SHUFFLE/ REPEAT modes are no longer displayed.

Note:

–The *SHUFFLE* and *REPEAT* functions cannot be used simultaneously.

Programming audio files

You may store up to 40 audio files in the desired sequence. If you like, store any track more than once.

- 1 Press and hold **PROG** on the remote control to store.
→ **PROG** flashes, and *PR* □ *I* is displayed.
- 2 Press **◀◀/▶▶** to select your desired track number.
- 3 For MP3/WMA, you may press **PRESET +/-** on the system (or **ALBUM/PRESET ▲/▼** on the remote control) to select a desired album, then select your desired track.
- 3 Repeat **steps 1-2** to select and store all desired tracks.
→ *PROGRAM FULL* is displayed if you attempt to programme more than 40 tracks.
- 4 To start playback of your programme, press **▶II**.
- 5 To stop playback, press and hold **PROG**.

To review the programme

- Press and hold **PROG** to stop playback, then press **◀◀/▶▶**.

To delete the programme

- Press and hold **PROG** once in the STOP mode;
- Press **PROG** twice during playback.
→ **PROG** disappears from the display.

Note:

– For compatibility reasons, the album/track information may differ from what it is displayed through flash players' music management software.

Playing Apple iPod using DC910

The set is equipped with a dock for iPod. By connecting Apple iPod to the set, you can listen to the sound of the docked iPod through the powerful speakers of the Hi-Fi system and view the iPod video (if available).

Compatible iPod player

- Apple iPod models with 30-pin dock connector as follows:
20GB, 40GB, 20/30GB Photo, 40/60GB Photo, 30GB Video, 60GB/80 Video, Mini, Nano 1st / 2nd/3rd generation, iPod 5th generation (video), iPod touch and iPod classic.
- iPod Shuffle is not supported.

Dock adaptor

Before plugging your player in the dock, snap the suitable dock adaptor (supplied) into the dock to provide a snug fit for the player to be docked.

Selecting the correct dock adaptor

- 3 iPod dock adaptors are included. Each adaptor has indication to match different iPod types.

Installing the dock adaptor

- As shown below, align the slots of the dock and latches of the adaptor; then slide in the adaptor.

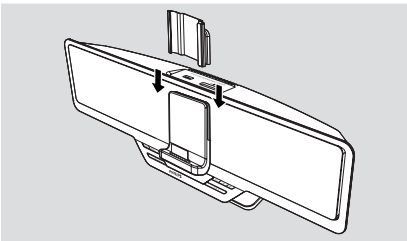

Removing the dock adaptor

- As shown, slide the adaptor up to take it out.

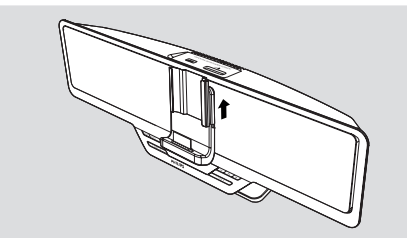

Playing Apple iPod

- 1 Correctly place the iPod in the dock.

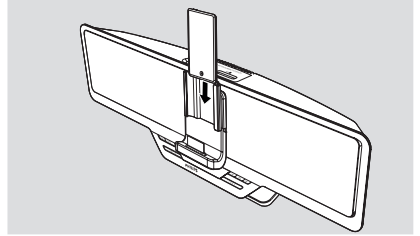

- 2 Press repeatedly **SOURCE** on the main unit to select iPod mode (or **iPod** on the remote control).
- 3 Power on your iPod.
- 4 Select and playback your favourite song/video/photo on the iPod.

Notes:

– Using the following buttons only (▶||, ◀◀/▶▶, **VOLUME** and **MUTE**) on the DC910 and its remote control, you can control some iPod playback features, such as, Play/Pause, selecting next/previous track, fast forwarding/rewinding and changing volume.

– You may also use **TUNING +/-** and ▶ || on the remote control to navigate the iPod menu and confirm a selection.

Charging iPod battery using the dock

In normal standby or power-on mode, you can charge the iPod while docking.

Note:

– iPod charging is not available in **ECO** power standby mode.

Listening to an external source

This feature allows you to listen to music from the external equipment through the powerful speakers of the Hi-Fi system.

- 1 Use an Aux-in cable (supplied) to connect the AUX 1 or AUX 2 jack (3.5mm, located on the bottom panel) to an AUDIO OUT or headphone jack on an external device (such as TV, Laser Disc player; DVD player or CD recorder).
- 2 Press **SOURCE** on the system repeatedly (or **AUX** on the remote control) to select "AUX 1" or "AUX 2".

Note:

- *Refer to the operating instructions for the connected equipment for details.*

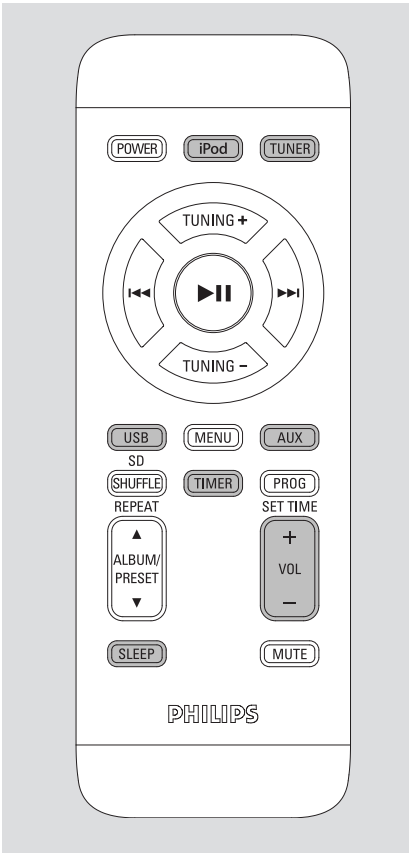

Clock setting

The clock can be set in either 12-hour or 24-hour mode (12HR or 24HR for example).

- 1 In standby mode, press and hold **PROG/SET TIME** on the remote control.
- 2 Press **VOLUME +/-** on the system (or **VOL +/-** on the remote control) to switch between 12 hour and 24 hour display.
- 3 Press **PROG/SET TIME** on the remote control again to confirm.
→ The clock digits flash on the display panel.
- 4 Press **VOLUME +/-** on the system (or **VOL +/-** on the remote control) to set the hours.
- 5 Press **PROG/SET TIME** on the remote control again.
→ The clock digits for the minutes flash.

- 6 Press **VOLUME +/-** on the system (or **VOL +/-** on the remote control) to set the minutes.
- 7 Press **PROG/SET TIME** on the remote control to confirm the time.

Timer setting

- The system can be used as an alarm clock, whereby the TUNER (FM)/iPod/USB/CARD (SD/MMC) is switched on at a set time (one time operation). The clock time needs to be set first before the timer can be used.
 - During setting, if no button is pressed within 30 seconds, the system will exit timer setting mode automatically.
- 1 In standby mode, press **TIMER** for more than two seconds.
 - 2 Press **SOURCE** on the system repeatedly (or the respective source keys on the remote control) to select the sound source.
 - 3 Press **TIMER** to confirm your desired mode.
→ The clock digits for the hours flash.
 - 4 Press **VOLUME +/-** on the system (or **VOL +/-** on the remote control) to set the hours.
 - 5 Press **TIMER** again.
→ The clock digits for the minutes flash.
 - 6 Press **VOLUME +/-** on the system (or **VOL +/-** on the remote control) to set the minutes.
 - 7 Press **TIMER** to confirm the time.
→ The timer is now set and activated.

Activating and deactivating timer

- In standby or during playback, press **TIMER once** on the remote control.
→ Display shows  if activated, and disappears if deactivated.

Notes:

- Timer is not available in AUX mode.
- If USB/SD/MMC source is selected and no compatible USB/SD/MMC device is plugged, TUNER will be selected automatically.

Sleep timer setting

The sleep timer enables the system to switch off by itself after a set period of time.

- 1 In power on mode, press **SLEEP** on the remote control repeatedly to select a preset time.
→ The selections are as follows (time in minutes):
120 → 90 → 60 → 45 → 30 → 15 → OFF → 120 ...
→ "SLEEP xx" is displayed. "xx" is the time in minutes.
→ "SLEEP" is displayed if the sleep time you have selected is not **OFF**.
- 2 When you reach the desired length of time, stop pressing the **SLEEP** button.

To deactivate the sleep timer

- Press **SLEEP** repeatedly until "OFF" is displayed, or press **POWER**.

AMPLIFIER

Output power	2 x 15 W RMS
Signal-to-noise ratio	≥ 70 dBA
Frequency response	20 Hz – 20 KHz, ± 3 dB
Input sensitivity AUX	0.5 V (max. 2 V)
Impedance loudspeakers	4 Ω

TUNER

FM wave range	87.5 – 108 MHz
Antenna	
FM	75 Ω wire

USB PLAYER/SD/MMC CARD

USB	12Mb/s, V1.1
.....	support MP3 and WMA files
Number of albums/folders	maximum 99
Number of tracks/titles	maximum 400

GENERAL INFORMATION

AC Power	100 – 240 V, 50/60 Hz
Dimensions (w x h x d).....	500 x 165 x 120.7 (mm)
Weight	3 kg
Standby power consumption	<2 W
Eco power standby	<1 W

Specifications and external appearance are subject to change without notice.

Maintenance

Cleaning the Cabinet

- Use a soft cloth slightly moistened with a mild detergent solution. Do not use a solution containing alcohol, spirits, ammonia or abrasives.

Troubleshooting

WARNING

Under no circumstances should you try to repair the system yourself, as this will invalidate the warranty. Do not open the system as there is a risk of electric shock.

If a fault occurs, first check the points listed below before taking the system for repair. If you are unable to remedy a problem by following these hints, consult your dealer or Philips for help.

Problem	Solution
Radio reception is poor.	<ul style="list-style-type: none">✓ If the signal is too weak, adjust the antenna.✓ Increase the distance between the Micro HiFi System and your TV or VCR.
The system does not react when buttons are pressed.	<ul style="list-style-type: none">✓ Remove and reconnect the AC power plug and switch on the system again.
Sound cannot be heard or is of poor quality.	<ul style="list-style-type: none">✓ Adjust the volume.
The remote control does not function properly.	<ul style="list-style-type: none">✓ Select the source (iPod or TUNER, for example) before pressing the function button (▶ , ◀◀/▶▶).✓ Reduce the distance between the remote control and the system.✓ Insert the battery with its polarities (+/- signs) aligned as indicated.✓ Replace the battery.✓ Point the remote control directly toward IR sensor on the front of the system.
The timer is not working.	<ul style="list-style-type: none">✓ Set the clock correctly.✓ Switch on the timer.
The Clock/Timer setting is erased.	<ul style="list-style-type: none">✓ Power has been interrupted or the power cord has been disconnected. Reset the clock/timer.
Some files on the USB device are not displayed.	<ul style="list-style-type: none">✓ Check if the number of folders exceeds 99 or the number of titles exceeds 400.
“DEVICE NOT SUPPORTED” scrolls on the display.	<ul style="list-style-type: none">✓ Remove the USB mass storage device or select another source.

Meet Philips at the Internet
<http://www.philips.com>

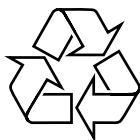

DC910

