

23

PIONEER

Service Manual

REPAIR & ADJUSTMENTS

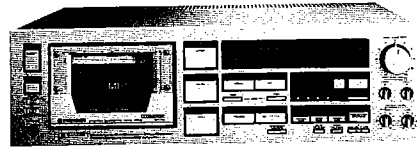

**ORDER NO.
ARP-449-0**

STEREO CASSETTE TAPE DECK

CT-A9

MODEL CT-A9 COMES IN SEVEN VERSIONS DISTINGUISHED AS FOLLOWS:

Type	Voltage	Remarks
KU	AC120V only	U.S.A. model
KC	AC120V only	Canada model
HEM	AC220V (240V)	European continent model
HB	AC240V (220V)	United Kingdom model
HP	AC240V (220V)	Australia model
D	AC120V, 220V, 240V (switchable)	General export model
D/G	AC120V, 220V, 240V (switchable)	U.S. Military model

- This service manual is applicable to the KU type. For servicing of the other types, please refer to pp. 72~79.
- For the circuit and mechanism descriptions, please refer to the CT-A9 service manual (ARP-462-0).
- Ce manuel d'instruction se réfère au mode de réglage, en français.
- Este manual de servicio trata del método de ajuste escrito en español.

CONTENTS

1. SAFETY INFORMATION	2	9. ELECTRICAL PARTS LIST	29
2. SPECIFICATIONS	3	10. SCHEMATIC DIAGRAM	37
3. FRONT PANEL FACILITIES	4	11. ADJUSTMENTS	45
4. DISASSEMBLY	8	RÉGLAGE	54
5. PARTS LOCATION	9	AJUSTE	63
6. EXPLODED VIEW	11	12. SUPPLEMENT FOR KC, D, HEM, HB AND	
7. PACKING	19	HP TYPES	72
8. P.C. BOARDS CONNECTION DIAGRAM	21		

PIONEER ELECTRONIC CORPORATION 4-1, Meguro 1-Chome, Meguro-ku, Tokyo 153, Japan
PIONEER ELECTRONICS [USA] INC. P.O. Box 1760, Long Beach, California 90801 U.S.A.
PIONEER ELECTRONIC [EUROPE] N.V. Keetberglaan 1, 2740 Beveren, Belgium
PIONEER ELECTRONICS AUSTRALIA PTY. LTD. 17B-1B4 Boundary Road, Braeside, Victoria 3195, Australia

1. SAFETY INFORMATION

1. SAFETY PRECAUTIONS

The following check should be performed for the continued protection of the customer and service technician.

LEAKAGE CURRENT CHECK

Measure leakage current to a known earth ground (water pipe, conduit, etc.) by connecting a leakage current tester such as Simpson Model 229-2 or equivalent between the earth ground and all exposed metal parts of the appliance (input/output terminals, screwheads, metal overlays, control shaft, etc.). Plug the AC line cord of the appliance directly into a 120V AC 60Hz outlet and turn the AC power switch on. Any current measured must not exceed 0.5mA.

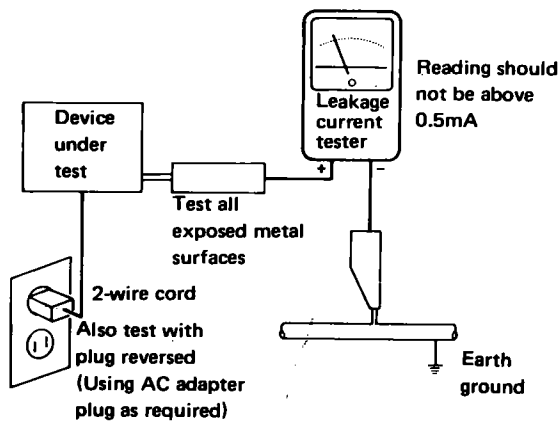

AC Leakage Test

ANY MEASUREMENTS NOT WITHIN THE LIMITS OUTLINED ABOVE ARE INDICATIVE OF A POTENTIAL SHOCK HAZARD AND MUST BE CORRECTED BEFORE RETURNING THE APPLIANCE TO THE CUSTOMER.

2. PRODUCT SAFETY NOTICE

Many electrical and mechanical parts in the appliance have special safety related characteristics. These are often not evident from visual inspection nor the protection afforded by them necessarily can be obtained by using replacement components rated for voltage, wattage, etc. Replacement parts which have these special safety characteristics are identified in this Service Manual.

Electrical components having such features are identified by marking with a Δ on the schematics and on the parts list in this Service Manual.

The use of a substitute replacement component which does not have the same safety characteristics as the PIONEER recommended replacement one, shown in the parts list in this Service Manual, may create shock, fire, or other hazards.

Product Safety is continuously under review and new instructions are issued from time to time. For the latest information, always consult the current PIONEER Service Manual. A subscription to, or additional copies of, PIONEER Service Manual may be obtained at a nominal charge from PIONEER.

2. SPECIFICATIONS

System	4 track, 2 channel stereo
Heads	"Ribbon Sendust" recording/playback combination head x 1, Erasing head x 1
Motor	Quartz PLL D.D. capstan motor x 1 Coreless reel motor x 1
Wow/Flutter	No more than 0.018% (WRMS) No more than $\pm 0.048\%$ (DIN)
Fast Winding Time	Approx. 80 seconds (C-60 tape)
Frequency Response	
-20 dB recording:	
Normal tape	20 to 21,000 Hz (30 to 19,000 Hz ± 3 dB)
Chrome tape	20 to 22,000 Hz (25 to 20,000 Hz ± 3 dB)
Metal tape	20 to 23,000 Hz (25 to 21,000 Hz ± 3 dB)
0 dB recording:	
Chrome tape	20 to 11,000 Hz
Metal tape	20 to 16,000 Hz
Signal-to-Noise Ratio	
Dolby NR OFF	More than 58 dB
Noise Reduction Effect	
Dolby type B NR ON	More than 10 dB (at 5 kHz)
Dolby type C NR ON	More than 19 dB (at 5 kHz)
Harmonic Distortion	No more than 0.8% (0 dB)
Input (Sensitivity)	
LINE (INPUT)	63 mV (Input impedance 100 k Ω)
Output (Reference level)	
LINE (OUTPUT)	0,63 V (Output impedance 7 k Ω)
Headphone	0,45 mW (Load impedance 8 Ω)

MISCELLANEOUS

Power Requirements	
KU, KC models	AC 120 V, 60 Hz
HEM model	AC 220 V, 50/60 Hz
HB, HP models	AC 240 V, 50/60 Hz
D, D/G models	AC 120/220/240V, 50/60 Hz (switchable)
Power Consumption	
KU, KC models	52 watts
HEM, HB, HP models	57 watts
D, D/G models	46 watts
Dimensions	420 (W) x 130 (H) x 374 (D) mm 16-9/16 (W) x 5-1/8 (H) x 14-12/16 (D) in
Weight (without packaging)	10 Kg (22 lb 1 oz)

FURNISHED PARTS

Operating instructions	1
Connection cord with pin plug	2

SUBFUNCTIONS

- MOL balance control type AUTO BLE
- Dolby NR system (type B and C)
- Quartz PLL D.D. capstan motor
- Closed loop dual capstan
- One touch MS, one touch tape return
- Auto monitor
- Auto tape selector function
- Dual mode counter
- Auto rec mute
- Recording level warning zone switch
- Auto loading/power eject
- Timer standby function

NOTES:

1. Reference Tapes:
Normal and LH: DIN 45513/BLATT6 or equiv.
CrO₂ DIN 45513/BLATT7 (CrO₂) or equiv.
2. Reference Recording Level: Meter 0 dB indicating level (160 nwb/m magnetic level = Philips cassette reference level)
3. Reference Signal: 315 Hz
4. Wow and Flutter: • JIS (3 kHz, with acoustic compensation (weighted) rms value); DIN 3,150Hz with acoustic compensation (weighted) PEAK value DIN 45507
5. Frequency Response: • Measured at -20 dB level, DOLBY NR OFF, level deviation is ± 6 dB without indication.
6. Signal-to-Noise Ratio: • Measured at 3rd harmonic distortion 3% level, weighted (DIN 45513/BLATT7)
7. Sensitivity: Input level (mV) required for reference recording level with input (REC) level control set to maximum
8. Maximum Allowable Input: While decreasing settings of input (REC) level controls and increasing level at input jacks, this is the maximum input level (mV) at the point where recording amplifier OUTPUT waveform becomes clipped.
9. Reference Output Level: Playback output level when meter indicates 0 dB.
10. This model does not employ a recording/playback connector (DIN-type).

NOTE:

Specifications and the design are subject to possible modifications without notice due to improvements.

3. FRONT PANEL FACILITIES

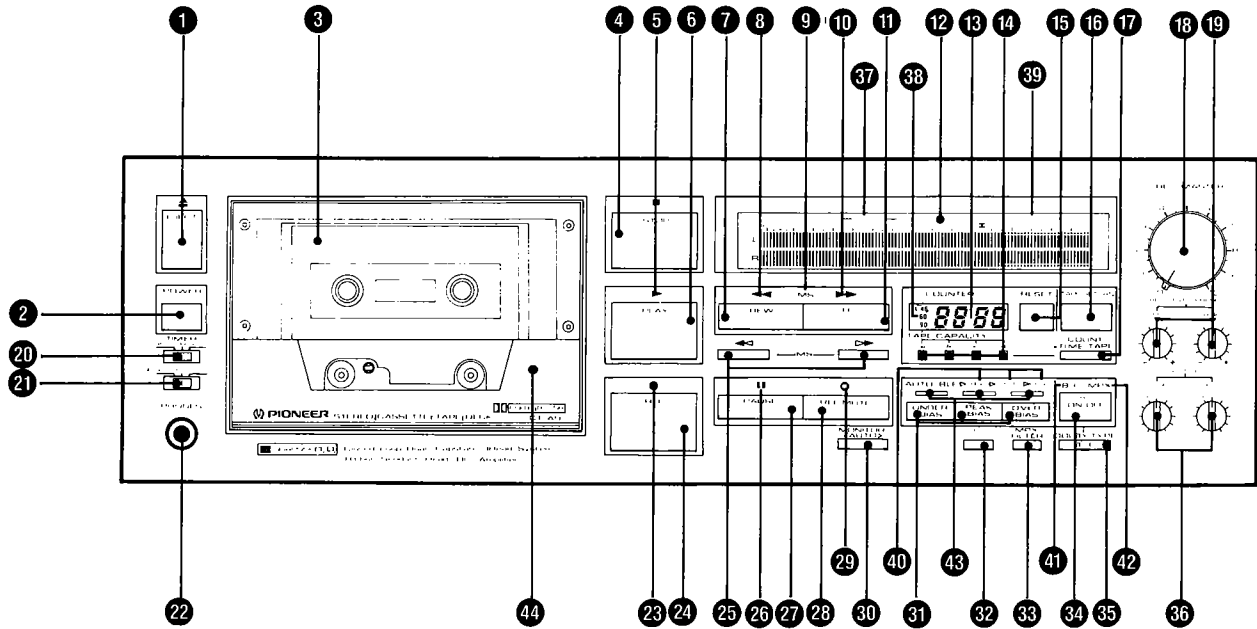

1 EJECT BUTTON

Press this button to open the cassette door. Whenever inserting or removing a cassette tape, be sure that the power is turned ON.

2 POWER SWITCH

When this switch is depressed power is turned ON, and when it is depressed again, power is turned OFF. After the power is turned ON, the unit will not operate for a duration of 4 seconds which is the necessary time for the unit to become stable.

3 CASSETTE DOOR

This door opens when the EJECT button is pressed. Insert cassette tapes with the visible part of the tape downward. When a cassette tape is inserted, the cassette door will automatically close. The cassette door will also close if it is lightly pressed. Unless the unit is powered, the door can not be opened.

NOTE:

If the cassette door is closed after turning the power off, the next time the power is turned ON and an operating switch is pressed, the cassette door will open and close once. This is in order to reset the microprocessor to the correct condition, and is not a malfunction.

4 STOP SWITCH

Depress this switch to stop the tape travel and to release the operating switches.

5 PLAY INDICATOR (▶)

This indicator lights when the PLAY switch is pressed. It also lights when the REC switch is pressed to set the unit in the recording mode.

6 PLAY SWITCH

Depress this switch to playback a tape.

7 REW SWITCH

Depress this switch to rewind the tape. (The tape will travel from right to left.)

8 REWIND INDICATOR (◀◀)

This indicator lights when the rewind switch (REW) is pressed. The indicator lights also when the music search (MS) ◀◀ switch is pressed.

9 MUSIC SEARCH INDICATOR (MS)

This indicator lights when either of the music search switches (◀◀ or ▶▶) is pressed.

10 FAST FORWARD INDICATOR (▶▶)

This lights when the fast forward (FF) switch is pressed. When the music search (MS) switch ▶▶ is pressed, the indicator also lights.

11 FF SWITCH

Depress this switch to send the tape forward. (The tape will travel from left to right.)

12 LEVEL METER

This indicates the recording level during recording and the output level during playback. The top part is for the left (L) channel and the bottom part for the right (R) channel.

13 DUAL MODE COUNTER (COUNTER)

This counter has two functions, "tape counter" and "real time counter," depending on the position of the counter mode switch (● TIME/TAPE).

When used as a "tape counter," the figures change as the tape travels and its transport position is indicated by a 4-digit number. When the RESET button is pressed, the counter is reset to "0000."

When the power is switched on, the counter functions as a "tape counter."

When used as a "real time counter," the remaining time on the tape during recording or playback is indicated. Set the TAPE CAPACITY switch to the position corresponding to the type of tape (length, hub diameter) being used.

14 TAPE CAPACITY SWITCH (TAPE CAPACITY)

When the dual mode counter is used as a real time counter, this switch is set in accordance with the tape type (tape length, hub diameter).

L46 For C-46 large hub diameter tapes.

46 For C-46 tapes.

60 For C-60 tapes.

90 For C-90 tapes.

NOTE:

For tapes other than those listed above, set to the position nearest to the actual length of the tape used. In those cases, there may be some difference in the time displayed.

15 RESET BUTTON (RESET)

Press this to reset the tape counter to "0000." Before recording or playback, press this button to reset the tape counter to "0000." It will then be easy to find programs on the tape if a note is made of the tape counter numbers and of the recording or playback contents. The numbers provide you with a guideline for finding programs afterward which you want to listen to. The tape counter can be reset while being used as a real time counter, however "0000" is displayed only while the RESET button is depressed.

16 TAPE RETURN SWITCH (TAPE RETURN)

When this switch is pressed, the fast forward or rewind functions will begin, sending the tape to the "0000" position, where it will automatically stop. This is a convenient function when you wish to listen immediately to a program you have just recorded, or when you wish to perform repeat play of a certain program.

17 COUNTER MODE SWITCH (● TIME/TAPE)

Push this switch to select the dual mode counter function.

18 REC MASTER VOLUME CONTROL (REC MASTER)

This control is for adjusting general recording levels. The recording level increases when the control is turned clockwise, and decreases when turned counter-clockwise. The control is equipped with a memory marker useful for remembering a predetermined volume level, for example when performing fade-in.

19 REC LEVEL PRESET VOLUME CONTROLS (REC LEVEL PRESET)

These are normally set in the click position (▼). After setting the general recording level with the recording master volume control, these controls can be used to finely tune the R and L channels' volume levels. The recording level is increased when the controls are turned in the (+) direction, and reduced when the controls are turned in the (-) direction.

20 TIMER SWITCH (TIMER)

This switch is used when an optional audio timer is utilized for unattended recording or wakeup playback.

NOTE:

The timer switch should always be in the OFF position when not performing timer recording or playback. If a cassette tape is inserted and the switch is set to the REC or PLAY position, the unit will automatically enter the recording or playback mode whenever the power switch is turned on.

21 BIAS SWITCH (Connected to TIMER SWITCH)

Depending on the program source to be recorded, this switch can be set in 3 positions to adjust the peak bias in a $\pm 15\%$ range. When you wish to emphasize high ranges or low ranges, you can choose a setting with deeper (more) or shallower (less) bias. When bias is shallow, the high ranges are extended, but distortion increases in proportion. Conversely when bias is deepened, the high ranges fall off, but distortion is lessened.

UNDER : Set to this position for recording music such as rock music with wide dynamic range in the high ranges, and substantial modulation of sounds.

PEAK : For recording most general kinds of music.

OVER : Set to this position when you wish to record classic and other similar music with increased middle and low range MOL, and low distortion.

NOTE:

This switch operates when the TIMER switch is set to the REC position.

22 PHONES JACK

This is the output jack for the stereo headphones.

23 RECORDING INDICATOR (●)

This lights when the unit is set to the recording mode.

24 REC SWITCH

This switch is pressed for recording. When the switch is pressed, the tape deck is placed in the recording standby mode, and the pause indicator (■ ■), play indicator (▶) and recording indicator (●) will light. To begin recording, press the PAUSE switch to release from the recording standby mode.

NOTE:

- *The switch cannot be placed in the ON position if the accidental erasure prevention tab on the cassette have been broken off, or if no cassette is in the unit.*
- *To release the tape deck from the recording mode, press the STOP switch.*

25 MUSIC SEARCH SWITCH (MS)

This switch is pressed when searching for the beginning of programs.

26 PAUSE INDICATOR (■ ■)

This indicator lights when the PAUSE switch is pressed. It also lights when the REC switch is pressed.

27 PAUSE SWITCH

Depress this switch to stop the tape travel temporarily during recording or playback. Depress this switch again to allow the tape to continue to travel.

The tape does not stop during fast forward or rewind operations even when the PAUSE switch is depressed.

28 REC MUTE SWITCH (REC MUTE)

When the unit is in the recording mode, if this switch is pressed, 4 seconds of non-recorded interval will be created automatically. This can be used for eliminating unwanted portions during recording, or for producing an appropriate non-recorded interval between programs.

Be careful not to press this switch except when necessary.

29 RECORDING MUTE INDICATOR (○)

This indicator flashes when the REC MUTE switch is pressed to create an automatic 4 second non-recorded portion. When a non-recorded portion longer than 4 seconds is created, the indicator changes from flashing to steadily lighted.

30 AUTO MONITOR SWITCH (AUTO MONITOR)

This unit is equipped with an automatic monitor function. This means that when the unit is in the recording standby mode, SOURCE MONITOR, or when in the playback mode, TAPE MONITOR is automatically selected. However, when you wish to select TAPE/SOURCE monitoring manually, this switch can be pressed. When the switch is pressed, the unit will switch to the mode opposite to that of prior to pressing the switch. For example, if the unit is in the TAPE MONITOR mode before the switch is pressed, it will switch to the SOURCE MONITOR.

The **TAPE**—MONITOR—**SOURCE** indicators in the level meter will light to show the monitoring mode.

31 BIAS SWITCHES (UNDER BIAS, PEAK BIAS, OVER BIAS)

These switches are used when adjusting the AUTO BLE to choose an under, peak, or over bias point. When these switches are pressed, the AUTO BLE operation begins. During BLE adjustment, the indicators above the switches flash as appropriate. When BLE adjustment is completed, the indicator for the appropriate switch lights steadily.

In order to protect against mistaken operation, the BLE operation will not start even if the switches are pressed unless the unit is in the stop condition.

32 AUTO BLE CLEAR SWITCH (CLEAR)

When this switch is pressed, the data set by the AUTO BLE system are cleared. After clearing, the bias, level and equalization are all set to the standard values selected by the auto tape selector.

NOTE:

When the unit is in the recording, playback, recording standby, or playback standby mode, data will not be cleared even if the clear switch is pressed. To clear data, perform this operation with the unit in the stop mode.

33 MULTIPLEX FILTER SWITCH (MPX FILTER)

Push this switch when recording FM stereo broadcasts or TV programs using the Dolby noise reduction system.

Contained among the FM stereo signals are a 19 kHz pilot signal and the 38 kHz subcarrier. The MPX FILTER switch is pressed in order to safeguard against incorrect operation of the Dolby circuit due to these signals. Release the switch for any other recording. The switch does not function during playback.

34 DOLBY NR SWITCH (DOLBY NR ON/OFF)

Press this switch ON when using the Dolby NR system for recording or playback. When the Dolby NR system is ON, the Dolby indicator B or C lights.

~~~~~  
 "Dolby" and the double-D symbol are trademarks of Dolby Laboratories Licensing Corporation.  
 Noise Reduction manufactured under license from Dolby Laboratories Licensing Corporation.  
 ~~~~~

35 DOLBY B/C SELECTOR SWITCH (DOLBY NR B/C)

This deck is equipped both type B and type C Dolby noise reduction systems. After the DOLBY NR ON/OFF switch is pressed, select type B or C using this switch. The Dolby indicator corresponding to the switch position lights.

36 OUTPUT LEVEL VOLUME CONTROLS (OUTPUT LEVEL)

These controls are for adjusting the deck's output level. When the controls are turned clockwise, output level is increased.

PHONES ... Adjusts output level at headphones jack.

LINE OUT ... Adjusts output level at LINE OUTPUT (PLAY) terminals on the rear panel.

NOTE:

- The movement of the level meters is not affected by rotation of the output level volume controls.
- If the output level control is set at the minimum "0" position, no sound will be heard, even if the amplifier's volume control is rotated.
- If the PHONES volume control is set at the minimum "0" position, no sound will be heard from headphones.

37 MONITOR INDICATOR (MONITOR)

This indicator shows the monitoring mode selected by the automatic monitoring function.

38 TAPE CAPACITY INDICATOR

This indicator shows the type of tape selected with the TAPE CAPACITY switch.

39 TAPE INDICATORS (NORM/CrO₂/METAL)

This mechanism uses the sensor holes on the cassette to detect the type of tape being used. It then automatically adjusts the proper recording bias and equalization for the tape. The type of tape is then shown on the tape indicator.

NORM: This indicator lights when normal tapes are used.

CrO₂: This indicator lights when CrO₂ tapes are used.

METAL: This indicator lights when metal tapes are used.

NOTE:

When using metal tapes without sensor holes, the tape selector will be set on the CrO₂ position. In this case, optimum recording and erasure may not be possible. We thus recommend that you use metal tapes with sensor holes. Pre-recorded metal tapes can be played as is on this unit.

40 BIAS, LEVEL, EQ ADJUSTMENT INDICATORS

The AUTO BLE performs adjustments in the order bias → level → equalizer. The BIAS, LEVEL, and EQ indicators light in order together with the adjustment process. When the equalizer adjustment is completed, the indicators go out:

41 DOLBY INDICATORS (DOLBY NR)

These light when the DOLBY NR switch is set to ON.

[B]: This lights when the B type Dolby noise reduction system is operating.

[C]: This lights when the C type Dolby noise reduction system is operating.

42 MULTIPLEX INDICATOR (MPX)

This indicator lights when the Multiplex filter (MPX FILTER) switch is pressed ON.

43 BIAS INDICATORS

In accordance with the setting of the bias switches, these indicators flash during AUTO BLE adjustment, and light steadily when adjustment is completed.

44 HEAD CLEANING ACCESS PORT

About Transparent Tape Cassettes

This unit is equipped with an automatic loading device which optically detects the presence of a tape cassette in the cassette holder, thus causing the cassette door to automatically close.

- Some tape cassettes are made from a transparent plastic material. The unit's auto loading device may not operate properly when these transparent tape cassettes are used.
- In this event, press the cassette door slightly with your finger, or use one of the direct operating switches (recording switch or playback switch) to close the cassette door.

4. DISASSEMBLY

● Tape Transport Mechanism
Remove screws (I) (front side) and (J) (upper side).

● Bonnet Case
Remove screws (A) (rear side) and (B).

● Panel Stay
Remove Nylon rivets (F) (upper side), and remove screws (H) (left and right side), (G) and (I) (front side).

● Bottom Plate
Remove screws (C).

● Front Panel
Pull off the knob (D), and remove screws (E) (upper and bottom side), and remove the upper and lower retaining hooks.

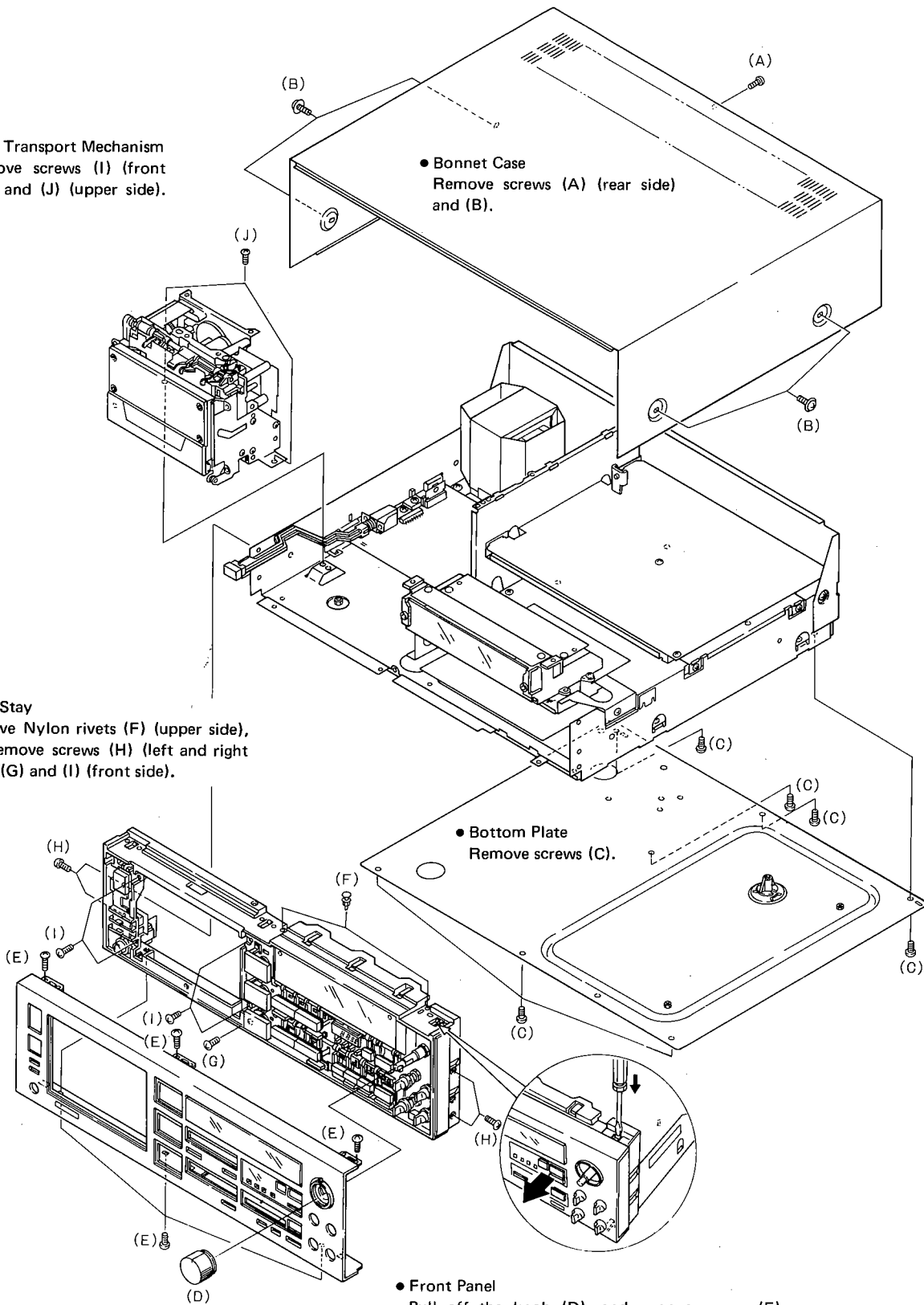

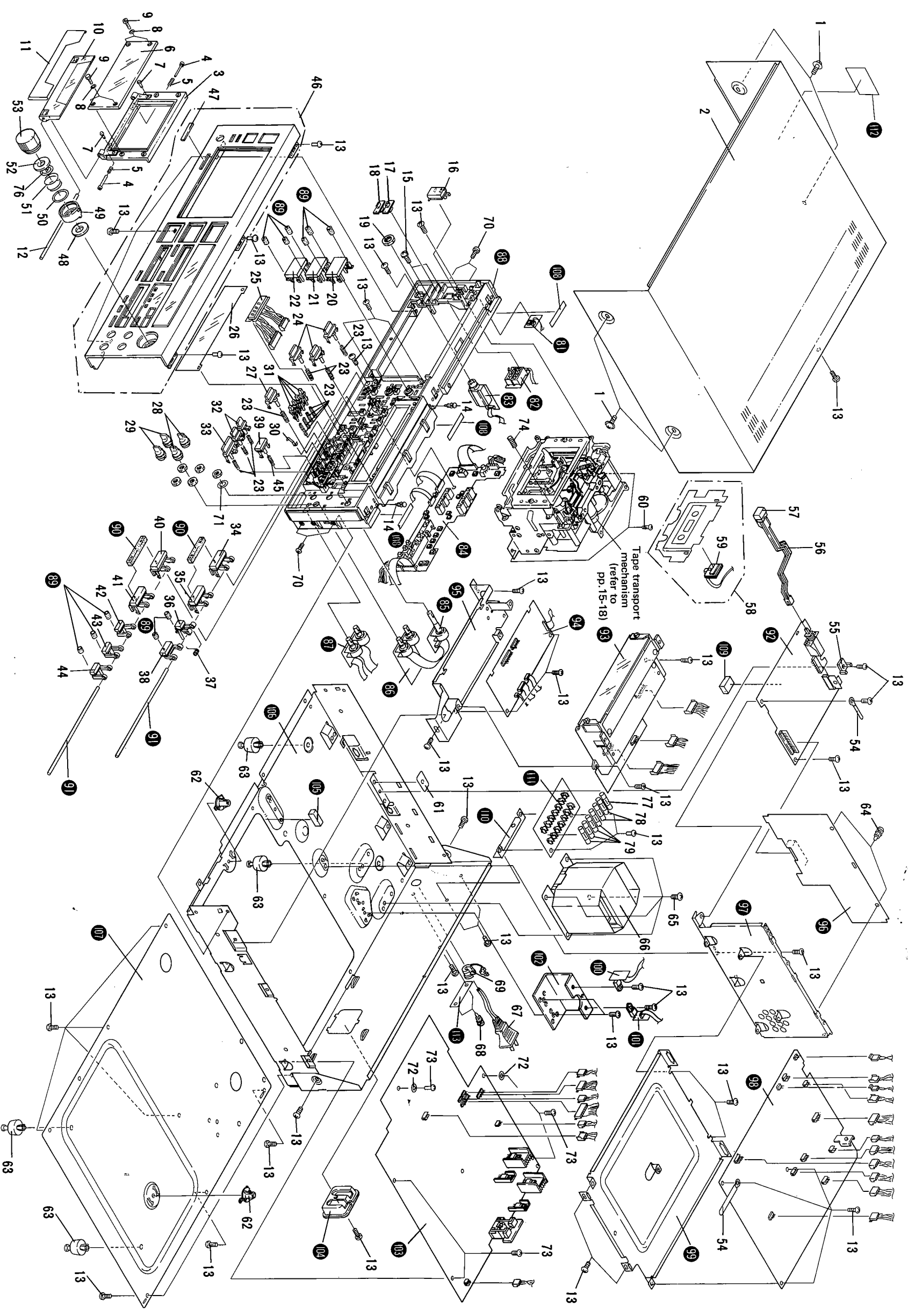

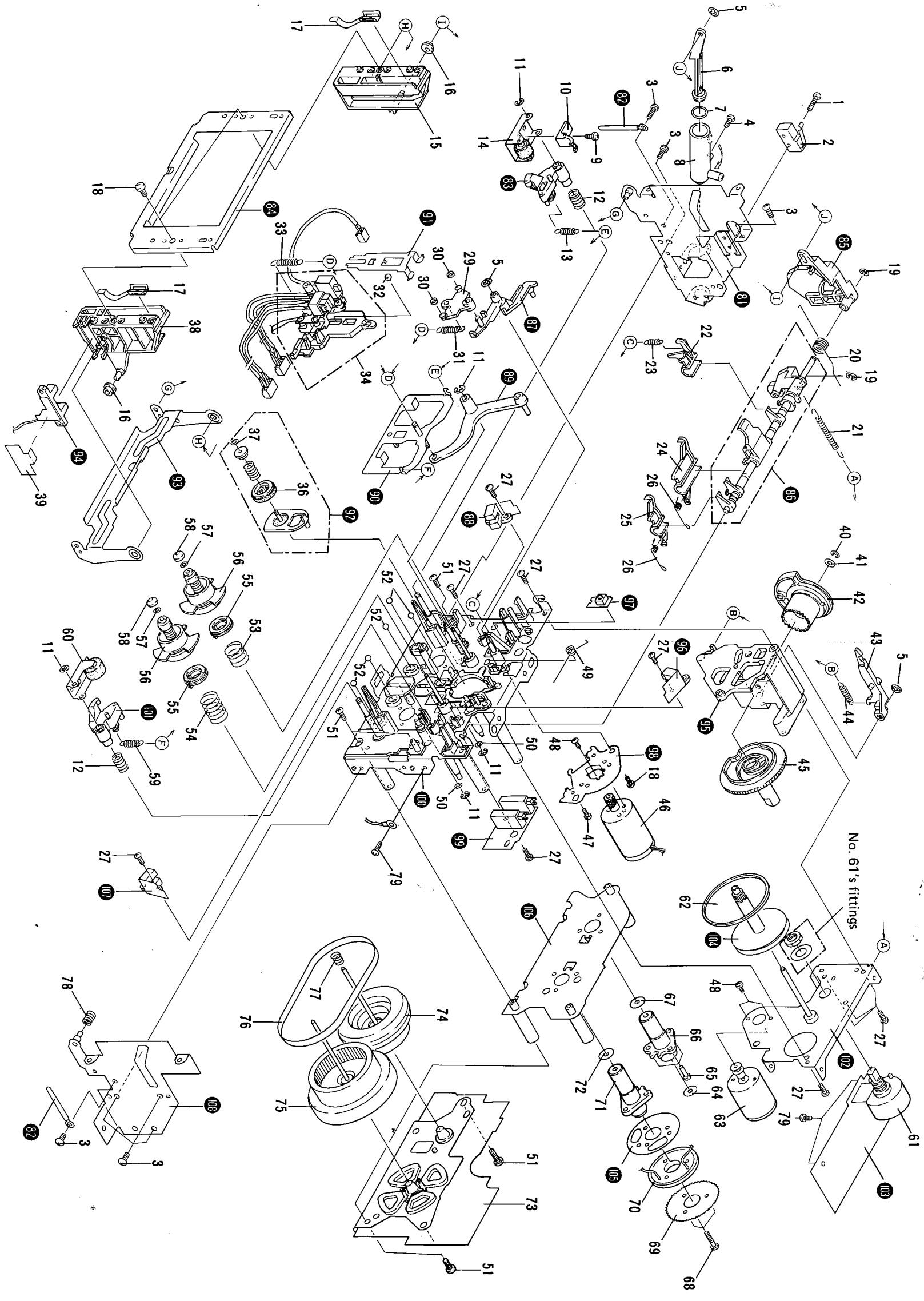

1 | 2 | 3 | 4 | 5 | 6

1 | 2 | 3 | 4 | 5 | 6

A | B | C | D

5. PARTS LOCATION

- NOTES:**
- Parts without part number cannot be supplied.
 - The Δ mark found on some component parts indicates the importance of the safety factor of the part. Therefore, when replacing, be sure to use parts of identical designation.
 - For your Parts Stock Control, the fast moving items are indicated with the marks **★★** and **★**.
 - **★★ GENERALLY MOVES FASTER THAN ★.**
- This classification shall be adjusted by each distributor because it depends on model number, temperature, humidity, etc.*

Front Panel View

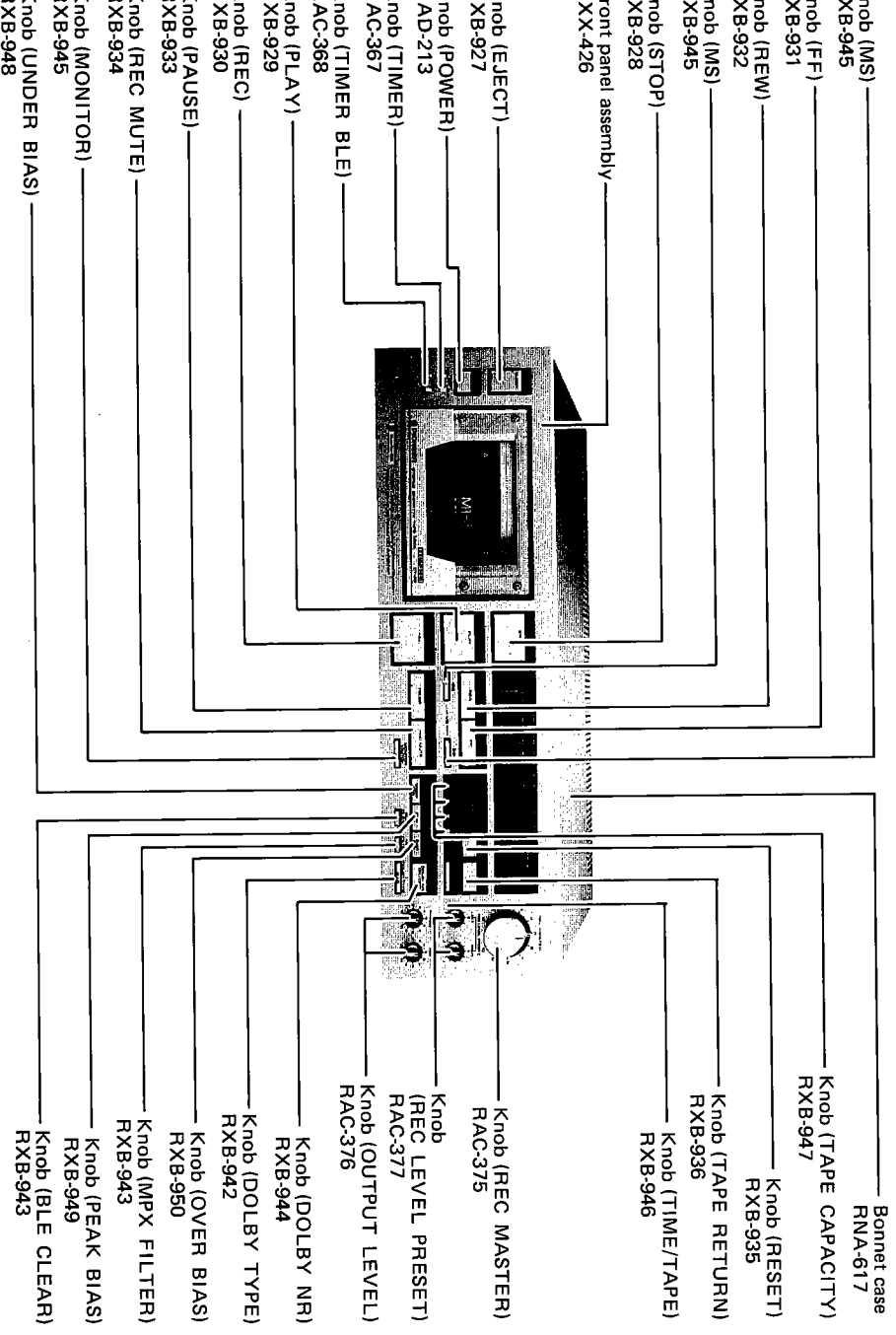

Front View with Panel Removed

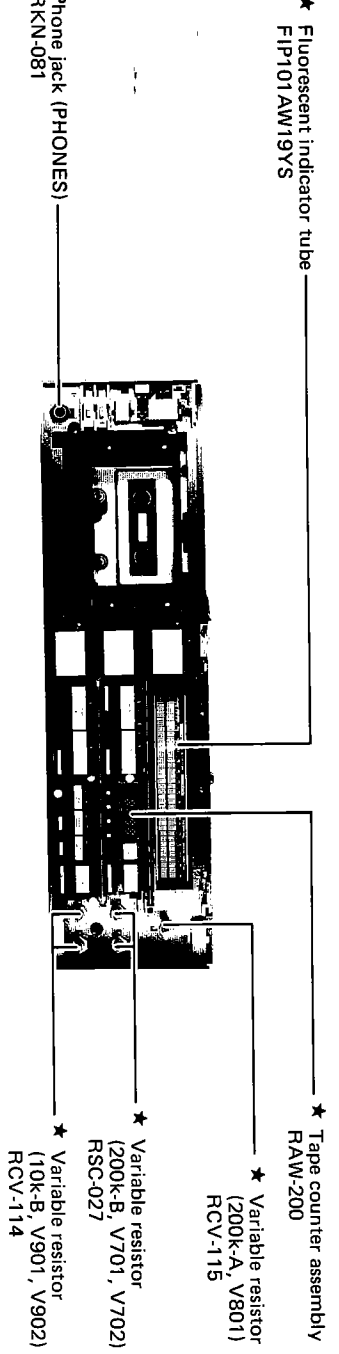

Top View

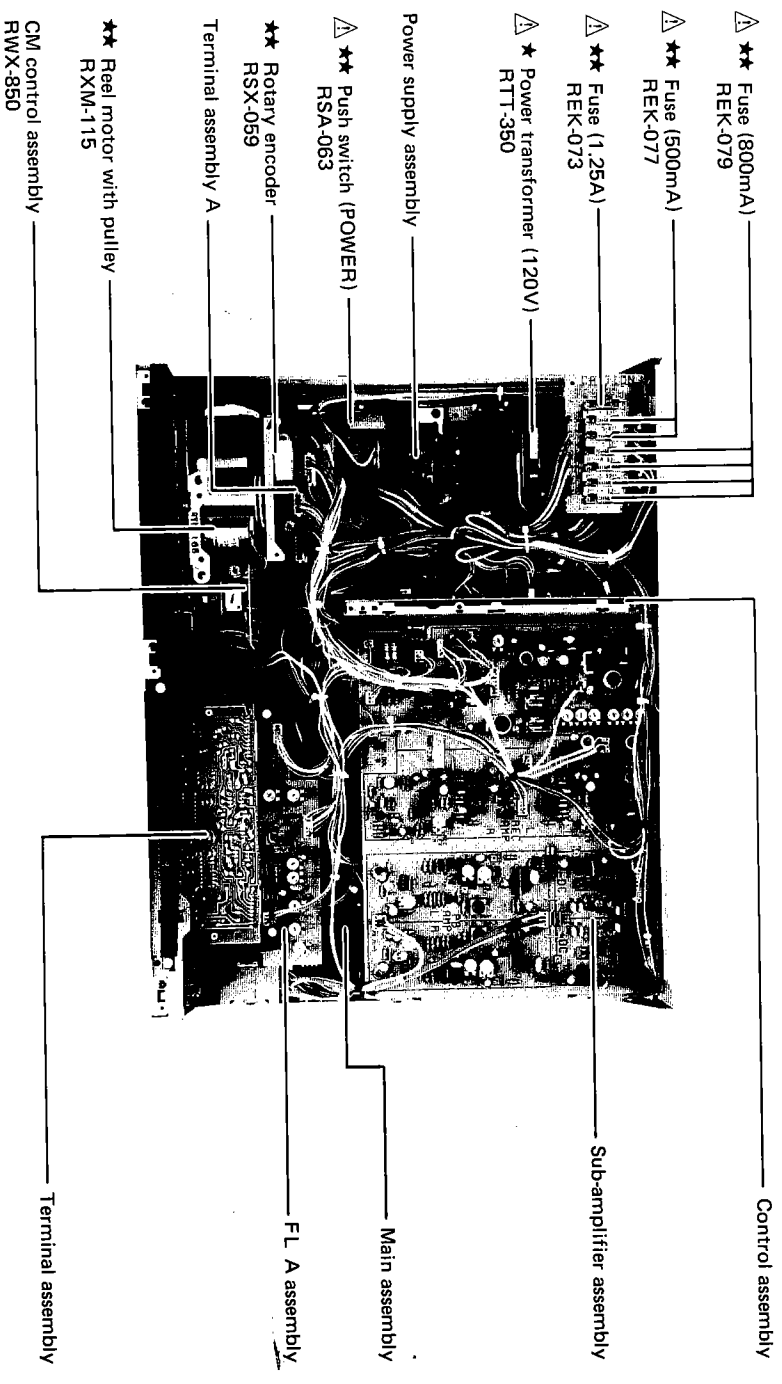

EXPLODED VIEWS

- Parts without part number cannot be supplied.
 - The Δ mark found on some component parts indicates the importance of the safety factor of the part. Therefore, when replacing, be sure to use parts of identical designation.
 - For your Parts Stock Control, the fast moving items are indicated with the marks **★** and **★**.
 - **★★ GENERALLY MOVES FASTER THAN ★**
- This classification shall be adjusted by each distributor because it depends on model number, temperature, humidity, etc.*

No.	Part No.	Description	Mark	No.	Part No.	Description
1	FBT40P080FNI	Screw 4 x 8		41	RXB-934	Knob (REC MUTE)
2	RNA-617	Bonnet case		42	RXB-948	Knob (UNDER BIAS)
3	RAH-488	Door frame		43	RXB-949	Knob (PEAK BIAS)
4	RNL-794	Door shaft		44	RXB-950	Knob (OVER BIAS)
5	RBL-058	Door spring		45	RBL-060	Knob spring B
6	RNL-762	Door A		46	RXX-426	Front panel assembly
7	REB-423	Door cushion		47	RAH-482	Name plate
8	RBF-074	Washer		48	RED-203	Friction felt
9	RBA-086	Dressing screw		49	RAC-371	Marker ring
10	RNL-763	Door B		50	RBF-072	Marker washer
11	RAH-491	Inscription plate		51	RBL-054	Marker spring
12	RLB-539	Door shaft		52	RNL-764	Ring with hook
13	BBZ30P080FZK	Screw 3 x 8		53	RAC-375	Knob (REC MASTER)
14	RBM-002	Nylon rivet 3 x 8		54	RNH-184	Cord fixer
15	PMZ26P060FMC	Screw 2.6 x 6		55	RNK-511	Upper guide
16	RXB-927	Knob (EJECT)		56	RNL-766	Rod
17	RAC-367	Knob (TIMER)		57	RAD-213	Knob (POWER)
18	RAC-368	Knob (TIMER BLE)		58	RXX-427	Cassette plate assembly
19	RBN-006	Nut	★	59	SLE-201C	LED
20	RXB-928	Knob (SOTP)		60	VBT30P060FMC	Screw 3 x 6
21	RXB-929	Knob (PLAY)		61	REB-508	Insulator
22	RXB-930	Knob (REC)		62	RNL-792	Stud
23	RBL-056	Knob spring A		63	REC-369	Foot assembly
24	RXB-945	Knob (MS, MONITOR)		64	RBM-003	Nylon rivet 3 x 4.5
25	RAW-200	Tape counter assembly		65	VBZ40P080FMC	Screw 4 x 8
26	RNL-798	Meter screen	★	66	RTT-350	Power transformer (120V)
27	RXB-955	Knob (COUNTER)	Δ	67	RDG-048	AC power cord
28	RAC-377	Knob (REC LEVEL PRESET)	Δ	68	RBM-001	Plastic rivet
29	RAC-376	Knob (OUTPUT LEVEL)	Δ	69	REC-395	Strain relief
30	RNH-321	Ground spring		70	BBZ30P060FMC	Screw 3 x 6
31	RXB-947	Knob (TAPE CAPACITY)		71	RBF-078	VR washer
32	RXB-943	Knob (BLE CLEAR, MPX FILTER)		72	WA30W120R100	Washer
33	RXB-942	Knob (DOLBY TYPE)		73	ATZ30P080FMC	Screw 3 x 8
34	RXB-932	Knob (REW)		74	RBL-059	Grounding spring
35	RXB-931	Knob (FF)		75	
36	RXB-935	Knob (RESET)	Δ ★★	76	RBF-080	Washer
37	RBL-055	Grounding spring	Δ ★★	77	REK-073	Fuse (1.25A)
38	RXB-936	Knob (TAPE RETURN)	Δ ★★	78	REK-077	Fuse (500mA)
39	-RXB-944	Knob (DOLBY NR)	Δ ★★	79	REK-079	Fuse (800mA)
40	RXB-933	Knob (PAUSE)	★★	80	

Mark	No.	Part No.	Description
	81		Eject switch assembly
	82		Timer switch assembly
	83		Headphones jack assembly
	84		Operation switch assembly
	85		Master VR assembly
	86		Preset VR assembly
	87		Output VR assembly
	88		Panel stay assembly
	89		Knob cushion A
	90		Knob cushion B
	91		Main shaft
	92		Power supply assembly
	93		F.L full assembly (F.L A, F.L, Terminal)
	94		Counter driver assembly
	95		Shield plate
	96		Control assembly
	97		P.C. board holder
	98		Sub-amplifier assembly
	99		Shield plate A
	100		Transistor A assembly
	101		Transistor B assembly
	102		Heat sink
	103		Main assembly
	104		Phono jack spacer
	105		Cushion
	106		Chassis
	107		Bottom plate
	108		Cushion
	109		Cushion D
	110		P.C. board holder
	111		Fuse A assembly
	112		Caution label
	113		Serial number plate

10. Metal Erasure Current Adjustment						
	Mode	Input signal & test tape	Adjustment location	Measuring location	Adjustment value	Remarks
	REC	No input, STD-604 test tape	V303	TP11-GND	175mV AC	
11. Bias Trap Adjustment						
	Mode	Input signal & test tape	Adjustment location	Measuring location	Adjustment value	Remarks
	REC	No input, STD-604 test tape	L101 (left channel) L201 (right channel)	Left and right OUTPUT terminals	Minimum bias leak	Measure with AC voltmeter and oscilloscope
12. Recording Bias Adjustment						
<ul style="list-style-type: none"> Set the MONITOR switch to the SOURCE position, and adjust the OUTPUT level control to maximum level. 						
	Mode	Input signal & test tape	Adjustment location	Measuring location	Adjustment value	Remarks
1	REC-PAUSE	Apply a 6.3kHz/-20dBv (100mV) signal to the INPUT terminals	MASTER REC level control	Left and right OUTPUT terminals	-13.5dBv (211.3mV)	REC LEVEL PRESET control at click stop position
2	REC	Record the above signal onto the STD-608A test tape, and monitor playback simultaneously	V306 (left channel) V309 (right channel)	Left and right OUTPUT terminals (and MONITOR in the TAPE position)	After first turning V306 and V309 fully counter-clockwise, turn back clockwise and stop at a position where the level drops 3dB below the maximum playback level after passing through that maximum level position.	
3	REC	Record the above signal onto the STD-603 test tape, and monitor playback simultaneously	V304 (left channel) V307 (right channel)			
4	REC	Record the above signal onto the STD-604 test tape, and monitor playback simultaneously	V305 (left channel) V308 (right channel)			
After first turning V304 and V307 fully counter-clockwise, turn back clockwise and stop at a position where the level drops 2.5dB below the maximum playback level after passing through that maximum level position.						
13. Recording Level Adjustment <ul style="list-style-type: none"> Leave the DOLBY NR switch off. 						
	Mode	Input signal & test tape	Adjustment location	Measuring location	Adjustment value	Remarks
1	REC-PAUSE	Apply a 315Hz/-10dBv (316mV) signal to the INPUT terminals	MASTER REC level control	REC.DOL-L REC.DOL-R	-7.7dBv (412.1mV)	REC LEVEL PRESET control at click stop position
2	REC	Record the above signal onto the STD-608A test tape, and monitor playback simultaneously	V104 (left channel) V204 (right channel)	PBO.DOL-L PBO.DOL-R	-7.7dBv (412.1mV)	
3	Repeat the above steps using the STD-603 and STD-604 test tapes, adjusting to -7.7 ± 1.5 dBv.					

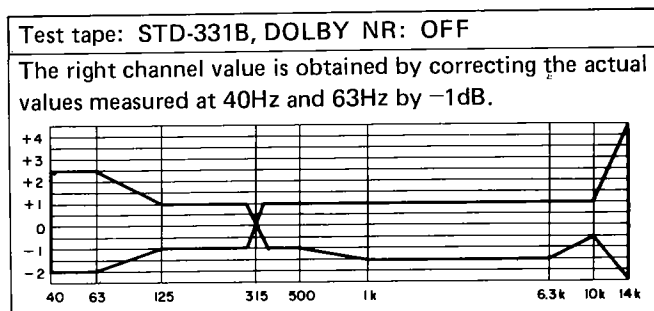

Fig. 11-9 Allowable playback frequency response zone

14. Recording and Playback Frequency Response Adjustment						
<ul style="list-style-type: none"> Leave the DOLBY NR switch off, and set the OUTPUT level control to maximum level. 						
	Mode	Input signal & test tape	Adjustment location	Measuring location	Adjustment value	Remarks
1	REC-PAUSE	Apply a 315Hz/-30dBv (31.6mV) signal to the INPUT terminals	MASTER REC level control	Left and right OUTPUT terminals	-23.5dBv (66.8mV)	REC LEVEL PRESET control is at click-stop position
2	REC	Record the 315Hz and 10kHz signals onto the STD-608A test tape at the above level and monitor the playback simultaneously	V306 (left channel) V309 (right channel)	Left and right OUTPUT terminals	Adjust the 10kHz playback level to +0.5dB higher than the 315Hz level	
3	Record and playback signals up to 15kHz onto the STD-608A test tape, and check that the allowable frequency response zone shown in Fig. 11-10 is satisfied (for DOLBY NR OFF, and B and C).					
4	REC	Likewise, record and playback the same signal onto the STD-603 test tape	V304 (left channel) V307 (right channel)	Left and right OUTPUT terminals	Adjust the 10kHz playback level to +0.5dB in respect to the 315Hz level	
5	Record and playback signals up to 15Hz onto the STD-603 test tape, and check that the allowable frequency response zone shown in Fig. 11-12 is satisfied (for DOLBY NR OFF, and B and C).					
6	REC	Likewise, record and playback the same signal onto the STD-604 test tape	V305 (left channel) V308 (right channel)	Left and right OUTPUT terminals	Adjust the 10kHz playback level to +0.5dB in respect to the 315Hz level	
7	Record and playback signals up to 15kHz onto the STD-604 test tape, and check that the allowable frequency response zone shown in Fig. 11-11 is satisfied (for DOLBY NR OFF, and B and C).					
15. AUTO-BLE Adjustment						
	Mode	Input signal & test tape	Adjustment location	Measuring location	Adjustment value	Remarks
1	STOP (REC)	Load the STD-608A tape, and short TP14 momentarily to GND	V601 (FL ADJ)	Adjust so that the AUTO-BLE indicator "LEVEL" lights up (level measurement at PBO.DOL-R)		Shorting TP14 to GND activates AUTO-BLE test mode
2	Press the STOP button to put tape transport into STOP mode, and then press the PEAK BIAS button.					
3	(REC)	Load the STD-608A tape	V602 (FH ADJ.)	Adjust so that the AUTO-BLE indicator "LEVEL" blinks.		
4	Press the DATA CLEAR button with the deck in STOP mode. Then load the STD-608A tape and press the PEAK BIAS button (Proceed to step 5 after completion of AUTO-BLE operation).					
5	REC	Record a 1kHz signal at 0VU onto the STD-608A tape, and monitor the playback simultaneously	Check	PBO.DOL-R	-7.7dBv±0.3dB	
			If the above specifications are not met, return to step 1 and compensate for level deviation by adjusting V601.			
6	Press the DATA CLEAR button with the deck in STOP mode. Then load the STD-608A tape and press the PEAK BIAS button (Proceed to step 7 after completion of AUTO-BLE operation).					
7	REC	Record signals from 315Hz to 10kHz at -20VU onto the STD-608A tape, and monitor the playback simultaneously	Check	Left and right OUTPUT terminals	Check that the zone specifications shown in Fig. 11-13 are satisfied for DOLBY NR OFF/B/C.	
8	Repeat steps 6 and 7 with STD-603 and STD-604 test tapes, and check that the Fig. 11-13 specifications are satisfied.					
9	Press the DATA CLEAR button with the deck in STOP mode.					
10	Repeat the above procedure for UNDER BIAS and OVER BIAS, and again check that the zone specifications shown in Fig. 11-13 are satisfied.					

