

**S.A.E. MARK VIII  
Stereo FM Digital Tuner**

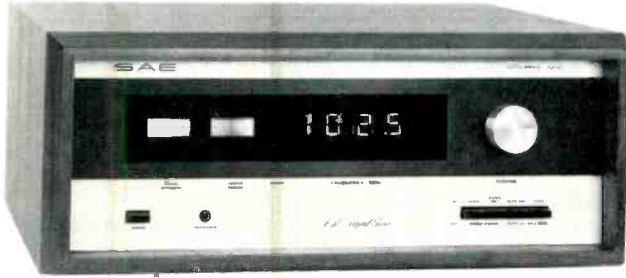

**MANUFACTURER'S SPECIFICATIONS**

**IHF Usable Sensitivity:** Mono, 1.6  $\mu$ V; stereo, 3.0  $\mu$ V. **50-dB Quieting:** Mono, 3.0  $\mu$ V; stereo, 30  $\mu$ V. **THD:** Mono, 0.15%; stereo, 0.20%. **S/N:** Mono, 70 dB. **Capture Ratio:** 1.5 dB. **AM Suppression:** 100 dB. **Image Rejection:** 100 dB. **Alternate-Channel Selectivity:** 120 dB. **Spurious Rejection:** 100 dB. **Frequency Response:** 20 Hz to 15 kHz  $\pm$ 0.5 dB. **Stereo Separation:** 1 kHz, 45 dB; 10 kHz, 35 dB. **Drift:** 15 kHz. **Rated Output Voltage:** 1.0 V rms.

**General Specifications**

**Power Requirements:** 110-125 V 50/60 Hz, 25 watts. **Dimensions:** 17 in. W x 5  $\frac{3}{4}$  in. H x 10  $\frac{1}{2}$  in. D. **Weight:** 23 lbs. **Price:** \$650.00.

The term "digital" as applied to an FM tuner may mean one of two things. Either the tuner employs crystal-controlled operation of a frequency-synthesis scheme, which insures absolute tuning accuracy and which readily lends itself to digital display of tuned frequencies, or the tuner employs conventional continuously variable tuning and has added digital "counting circuitry" and displays to replace the conventional tuning dial pointer and printed frequency scale. The SAE Mark VIII tuner falls in the latter category, which means that additional money is being spent on those attractive numeric readouts and associated circuits, and if LED readouts were all the SAE tuner had to commend it, we would have had to think twice about extolling its virtues. However, this particular "digital readout tuner" is such an excellent one in so many other respects that it is possible to overlook the extra cost on the premise that even without this digital display, the Mark 8 tuner would still be worth its price.

The front panel of the tuner has a long blacked-out section which becomes illuminated with giant numerals and a pair of meters when power is applied. Numbers change in increments of 0.2 MHz, and we were able to tune down to 87.5 and up to 108.5 MHz by turning the large tuning knob which is flywheel-coupled and behaves for all the world just like any other FM tuning knob. Four pushbuttons at the

lower left turn on power, select one of two muting threshold levels, activate the muting circuit, and select one of two output levels which are set 10 dB apart. A symmetrically positioned array of four more pushbuttons at the lower right activate a stereo noise filter, change de-emphasis from 75 microseconds to 25 microseconds, switch from mono to stereo, and select stereo-only reception. At the lower center of the panel is a tape-out jack (of the two-circuit variety similar to a headphone jack) to which a tape deck can be connected for recording purposes. High-impedance phones may also be connected at this point for direct listening to the tuner, bypassing the need for an amplifier. Between the signal-strength and center-of-channel tuning meters and the digital display areas is a stereo indicator light.

The rear panel of the SAE Mark VIII contains a pair of output jacks, vertical and horizontal 'scope jacks (for 'scope observation of multipath), a four-channel (detector) output jack, and a barrier-type terminal strip for connection of other 75-ohm or 300-ohm antenna transmission lines. A fuseholder containing a half-ampere line fuse is also accessible from the rear panel.

**Circuit Description**

Aside from the sealed front-end, the internal layout of the chassis contains two major circuit boards, both of glass-epoxy material. (See Fig. 2). The lower p.c. board contains i.f. and MPX circuitry, while the upper board contains the necessary IC logic circuits to activate the digital display. A block diagram of the tuner is shown in Fig. 3. A 5-ganged, capacitor-tuned front-end uses 3 MOS-FETs, two of which are used in a cascode-type r.f. amplifier. Five double-pole, monolithic, fixed tuned-resonance, pass-band filters are used in the i.f. section, coupled with seven symmetrically limiting differential-amplifier, IC limiter stages followed by a wideband ratio detector. Five of these limiter amplifiers have their output coupled to amplitude detectors which are connected to a summing amplifier to activate the logarithmically calibrated signal-strength meter.

A phase-locked-loop IC is used for MPX detection, followed by separate 19-kHz and 38-kHz, double-tuned, low-pass filters. Complementary d.c.-coupled, feedback pair amplifiers are used in the audio amplification chain.

A 4-digit readout system is coupled to the local r.f. oscillator. Readout is indicated by four seven-segment displays, which use a total of 56 LEDs. Fourteen digital ICs referenced to a quartz crystal having 0.004% accuracy, are used in the divide-down and frequency-counter logic system.



Fig. 1—Back panel view.

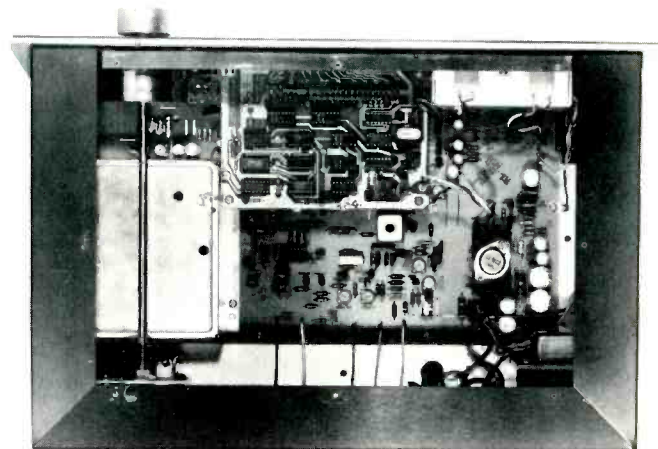

Fig. 2—Interior view.

## Laboratory Measurements

Noise and THD curves for mono and stereo operation of the Mark VIII tuner are plotted in Fig. 4. IHF Usable sensitivity in mono measured  $1.8 \mu\text{V}$  (10.5 dBf), while in stereo,  $4.2 \mu\text{V}$  (17.9 dBf) of signal was required to achieve the same noise-plus-THD level of 3%. The 50-dB quieting mark in mono was achieved with a signal input of only  $2.2 \mu\text{V}$  (12.2 dBf), about the lowest we have ever measured since this important new specification became a required disclosure. In stereo,  $25 \mu\text{V}$  (33.35 dBf) was needed to achieve 50 dB of quieting—again, much better than average. Ultimate S/N in mono measured 75 dB, while in stereo the best signal-to-noise reading was 73 dB, remarkably low compared with even higher priced tuners we have measured.

Harmonic distortion in mono was 0.13% at mid-frequencies; 0.15% in stereo. At the more difficult test frequencies of 100 Hz and 6 kHz, THD was 0.19% for both mono and stereo operating modes at 100 Hz, and 0.11% and 0.35% for the 6-kHz tests. Distortion versus frequency for the entire FM audio band is plotted along with stereo FM separation characteristics in Fig. 5.

Rejection ratios (image, i.f., and spurious) were all better than 100 dB—the limit of our test equipment. Capture ratio measured 1.4 dB, and AM suppression was an outstanding 97 dB, though some degree of error may have been introduced when trying to measure such high suppression ra-

tios. Alternate-channel selectivity was outstanding and well above 110 dB (again, our limit of measurement). Stereo separation was outstanding, with readings above 50 dB obtained for mid frequencies and 36 dB at 10 kHz. The two muting-threshold levels were set at the factory for  $3 \mu\text{V}$  (14.9 dBf) and  $13.0 \mu\text{V}$  (27.7 dBf), while stereo switching took place at  $4 \mu\text{V}$ , by which time S/N was already 35 dB below full output and THD was precisely at the 3% point deemed least usable. The 19-kHz and 38-kHz sub-carrier products at the output were filtered out to a level of -65 dB with respect to full modulation. What's more, this effective filtering is accomplished without significant alteration of frequency response, which remains true to the appropriate de-emphasis curve selected within 0.3 dB from 30 Hz to 15 kHz. That's really good low-pass filter design!

## Use and Listening Tests

It goes almost without saying that any tuner having such superb measured performance will be limited in practical use by the quality of signals broadcast in your area. Unfortunately, in the metropolitan New York area, where we perform our laboratory measurements and listening tests, there are but one or two really good FM signals, and even those don't measure up to the ability of this tuner to reproduce clean, quiet signals. We have learned that one station is about to undergo what amounts to a transmitter overhaul in an attempt to bring its broadcast signal quality up to that of

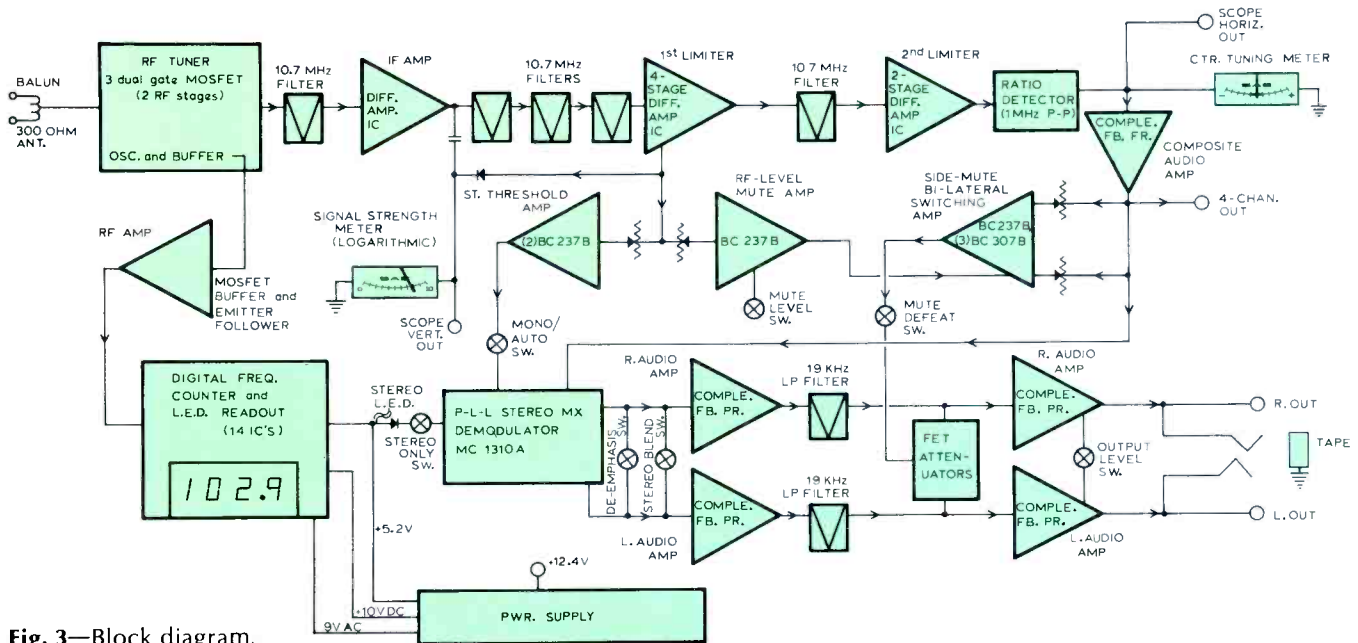

Fig. 3—Block diagram.

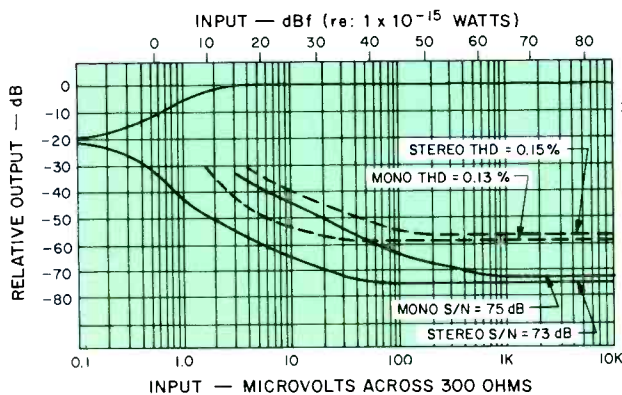

Fig. 4—FM quieting and distortion characteristics.

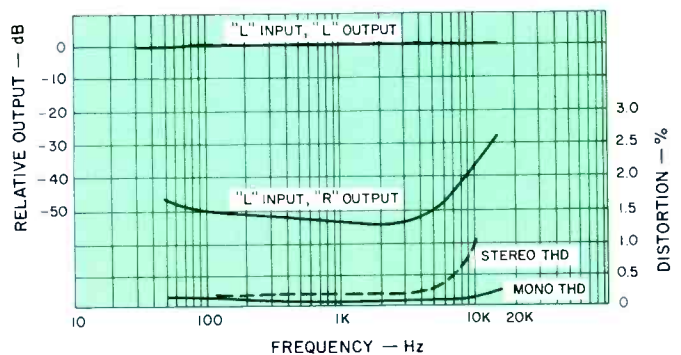

Fig. 5—Separation and distortion versus frequency.

some of the state-of-the-art tuners available. SAE's Mark VIII certainly is a tuner we will be most anxious to hear again when that station's signal has been refined—especially since the man who has been charged with the task is none other than Richard Sequerra, whose latest tuner design abilities are familiar to readers who follow *Audio's* test reports.

The only negative note I can sound is a personal expression that I find the giant digital readout somewhat splashy despite its high visibility from across the room. However, I have to admit that many people, if not the majority of po-

tential buyers, will find the display attractive. Since the performance would have been exactly the same if a conventional dial pointer and frequency scale had been used instead of the digital display, I wonder how much lower the price would have been without the display. And whether those who could then afford and would purchase the tuner wouldn't offset the number who were purchasing it simply because of the digital display. All this is, of course, idle speculation since taste is a rather unpredictable item.

Leonard Feldman

Check No. 92 on Reader Service Card

## Dynaco PAT-5 Preamplifier



### MANUFACTURER'S SPECIFICATIONS

**Frequency Response:** 10 to 50,000 Hz  $\pm$  1dB. **Rated Output:** 2 volts. **THD at Rated Output:** 0.05 per cent. **IM at Rated Output:** 0.05 per cent. **Signal-to-Noise Ratio:** 70 dB re 10 mV phono input. **Phono Sensitivity:** 2.7 mV. **Dimensions:** 13 1/2 in. W  $\times$  11 1/4 in. D  $\times$  4 1/4 in. H. **Weight:** 13 lbs. **Price:** \$369.00 wired, \$219.00 kit.

Dynaco's PAT-5 is a new solid-state design that supercedes as top of the line their first transistor preamp, the PAT-4 which is still being made. Physically, the PAT-5 is quite similar to the PAT-4 but is deeper and uses push-button switches instead of rocker switches. The chassis is made up of three pieces: front subpanel, bottom plate, and rear panel. The top cover is a U-shaped piece which encloses the top and sides. Active circuitry is distributed among five PC boards: power supply, two output section amps, and two phono preamps. There is considerable hard wiring that interconnects back panel input and outputs to the selector switch, PC boards, and front-panel controls. An internal shield runs from front to back, separating the speaker selector switch, power supply, speaker input and outputs, and a.c. wiring from the rest of the unit. Rotary controls on the front panel are used for the selector switch, volume, balance, tone controls, and speaker selector switch. Push-button switches handle the tape monitor functions, mode, filters, tone control in/out, and "EPL" function. (EPL stands for External Processor Loop.)

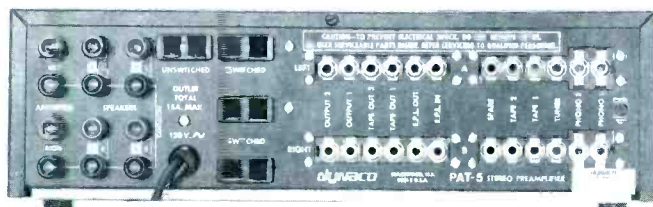

Fig. 1—Back panel view of the Dynaco PAT-5.

On the rear panel are the signal input and output connectors, a.c. line cord, and convenience outlets, and six pairs of five-way binding posts for connection of the system power amp outputs and two pairs of speakers.

### Circuit Description

As is fairly easy to see in Figs. 3 & 4, the PAT-5 has four amplifier blocks per channel: phono preamp, high-level-input voltage follower, high-cut filter amp, and tone control/output amp. The high-cut filter stage is completely bypassed when switched out. The high-level-input voltage follower, hereafter called the voltage follower, serves to present a constant input impedance (50 kOhms) for high-level inputs and to present a low output impedance to drive the parallel combination of the balance and volume control (10 kOhms).

From a signal flow standpoint, the input signal selected comes off of the selector switch and passes through the tape monitor and EPL switches to the input of the voltage follower. The EPL switch permits an external device, such as a frequency equalizer, to be switched in or out of the signal path at the input to the voltage follower. Coming out of the voltage follower, the signal passes in turn through the mode switch; low-cut filter, volume, and balance controls; high cut filter, and finally arrives at the input of the tone control/output amplifier. After passage through the output amp, the signal emerges at the main preamp outputs. From the foregoing, it is evident that a minimum of three amplifiers are in the signal chain when using the phono function.

The phono preamp is a two-stage common-emitter circuit, with RIAA equalization accomplished in the feedback

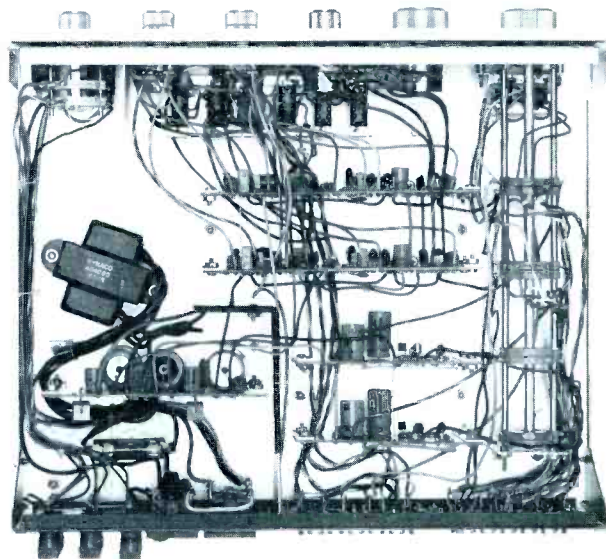

Fig. 2—Interior view.

loop from second-stage collector to first-stage emitter. Nominal 1-kHz equalized gain is 37 dB, although Dyna gives instructions in their manual for setting the gain from 34 to 43 dB in three dB steps. Further, one can wire the unit to have different gains for the *phono 1* and *phono 2* functions so that two different pickups can be used and have about the same output from the phono preamp.

The voltage follower is composed of a compound connection of opposite polarity transistors. The collector signal of Q301 drives the base of Q302, whose collector signal is all fed back to the emitter of Q301, thus forming a resultant emitter-follower with a voltage gain of about 1X.

High-cut filter action is accomplished with an active low-pass filter. Input emitter-follower Q303 presents a high-input impedance to the volume control and a low output impedance to the actual filter, which is a three-pole (three resistors and three capacitors) circuit involving emitter-follower Q304. Overall gain of the filter amp is slightly less than one.

The final 20 dB of total preamp gain is generated by the output/tone control amp. This output amp is a LM301 operational amplifier connected in a tone-control circuit that so far has been used in three other firms in two preamps and an integrated amplifier. It has the advantage that output-amplifier gain and tone-control action is accomplished in one circuit block, rather than two as is the common prac-

tice. Further, the circuit is noninverting and has high input impedance, allowing it to be driven directly from the volume control. The circuit arrangement of resistors, capacitors, and bass and treble control potentiometers is similar to the Baxandahl circuit used in many preamps but is different in two major respects. First, the control potentiometers are log taper, having 10 per cent of total resistance from end to wiper at 50 per cent mechanical rotation, and second, one of the two ends of the control pot divider string is grounded rather than being the signal input. The signal input for this circuit is the noninverting input of the op amp.

With the control pots at 50 per cent rotation, these pots and associated resistors and capacitors form two frequency-insensitive, 10/1 voltage dividers off of the amplifier output, with the wipers resistively summed into the inverting input of the op amp. This forms a closed-loop, noninverting, flat gain of 10X. Rotating either pot from center unbalances the frequency insensitivity of the associated divider and results in the closed-loop gain of the circuit giving a boost or cut in the associated frequency range. The tone control in/out switch, when out, substitutes a flat-resistive 10/1 divider for the feedback network around the output amplifier. An overall d.c. feedback loop is around the op amp, causing it to have a d.c. gain of one for good d.c. operating stability.

The power supply delivers Zener-regulated plus and minus 15 volts to the output amp and voltage follower and

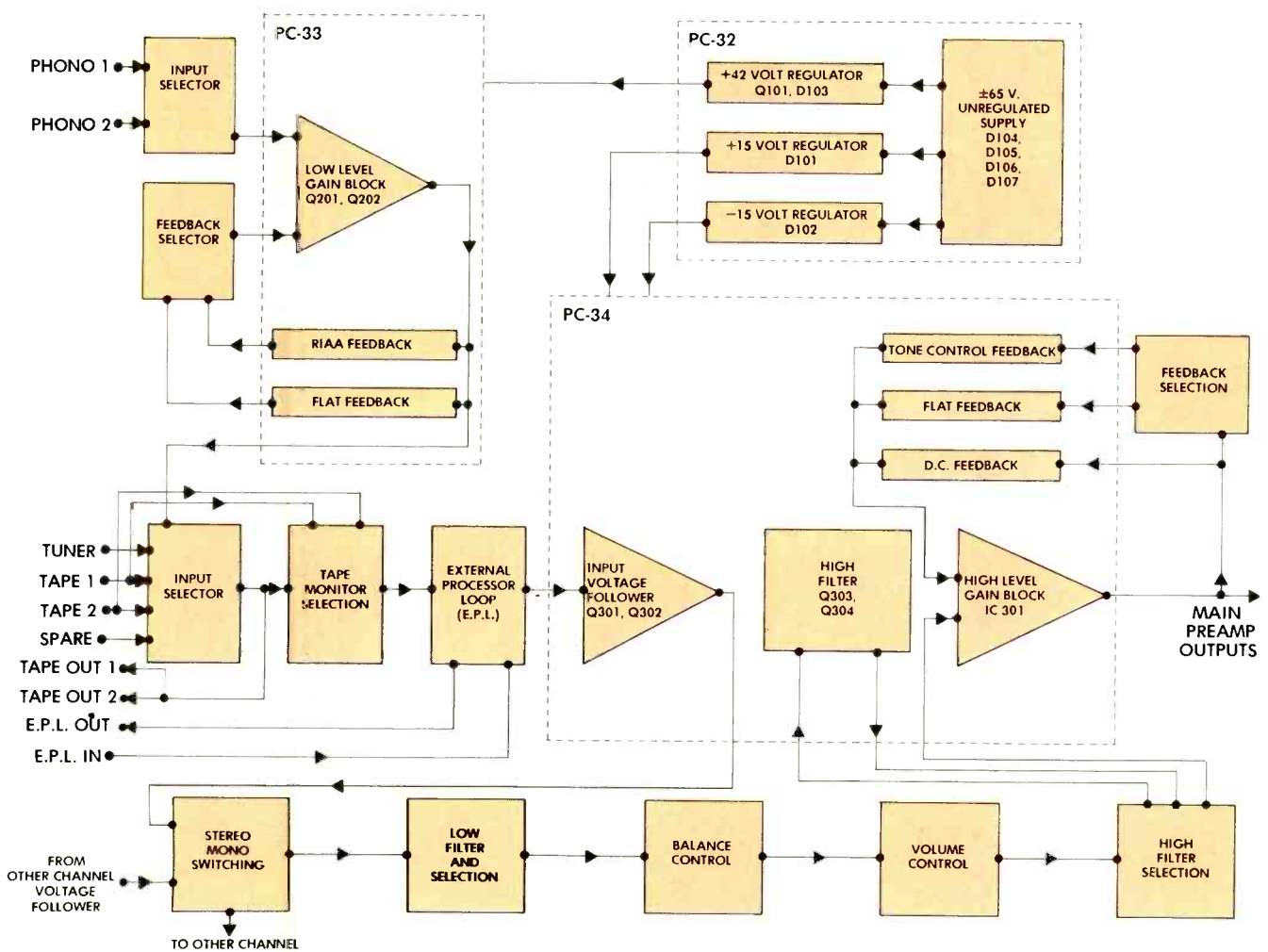

Fig. 3—Block diagram.

decoupled plus 15V to the filter amp. The raw, rectified plus d.c. is regulated by a Zener diode and emitter-follower to provide plus 42.5 volts to the phono preamps.

An interesting departure from conventional practice is used in the primary a.c. wiring of this unit. The circuit is always powered when plugged in, and the power switch merely controls the switched a.c. outlets. This makes good sense as the unit draws about 12 watts and, being continuously on, keeps the internal environment of the unit at a reasonably constant temperature, extending the life of components. Further, no annoying and potentially speaker damaging thumps occur when the entire system is powered on and off. Dynaco makes a concession to energy conservation purists by giving instructions for wiring the unit so that the preamp power is also switched by the power switch!

### Listening Tests

The PAT-5 was first listened to as a phono preamp only, with output signal taken at the tape-out jacks, followed by a dual 50K volume control directly into the power amp. A Supex SD-900 and Fidelity Research FR-1 MK II were the cartridges used through the reviewer's own pre-preamp and into the phono 1 inputs of the preamp. Listening was done with Dahlquist DQ-10 loudspeakers on loan from the maker for these tests and Stax SRX MK2 phones.

This preamp has an open sound with good overall definition, though, like other transistor preamps, it has some high frequency edginess and irritation. Bass reproduction is solid and well defined and generally on a par with other top-quality solid-state preamps. Switching in the output section of the PAT-5 caused a noticeable decrease in definition and some increase in high frequency edginess. All controls op-

erated well and with no noticeable switching pops or transients. The tone controls were judged particularly effective in making small corrections to the overall frequency response with different records and other program sources.

### Kit Builder' Comments

Although the PAT-5 was much easier to assemble than the ST-400 basic power amplifier (reviewed in *Audio*, p. 47, May 1975), it is not a kit I'd recommend to the beginning kit assembler because of the considerable amount of point-to-point wiring between the large selector switch assembly and the many input and output terminals (due to the unusually flexible input/output switching, as well as the EPL).

The 35-page manual is Dynaco's usual thorough job of presentation, and it has a circuit diagram as well as a detailed functional block diagram, both necessary for complete understanding of the extra features. Also included is a 17-by-22 in., full-size wiring and assembly diagram, showing every wire and component, which I taped to the wall over my work bench. At the bottom of the diagram, there's a 16-in. scale for measuring wire cut from the four hanks supplied.

Most of the circuitry is on the four preassembled PC boards—two identical audio boards and twin preamp boards. The audio boards are connected to the rest of the components via 27 edge-mounted solder eyelets, while the preamp boards have nine eyelets each. Only the board for the regulated power supply required assembly. Its seven capacitors, six diodes, and three resistors took 20 minutes to mount and solder in place.

Dynaco divided the wiring and assembly into six sections which are listed below with the number of steps and the time required to finish each:

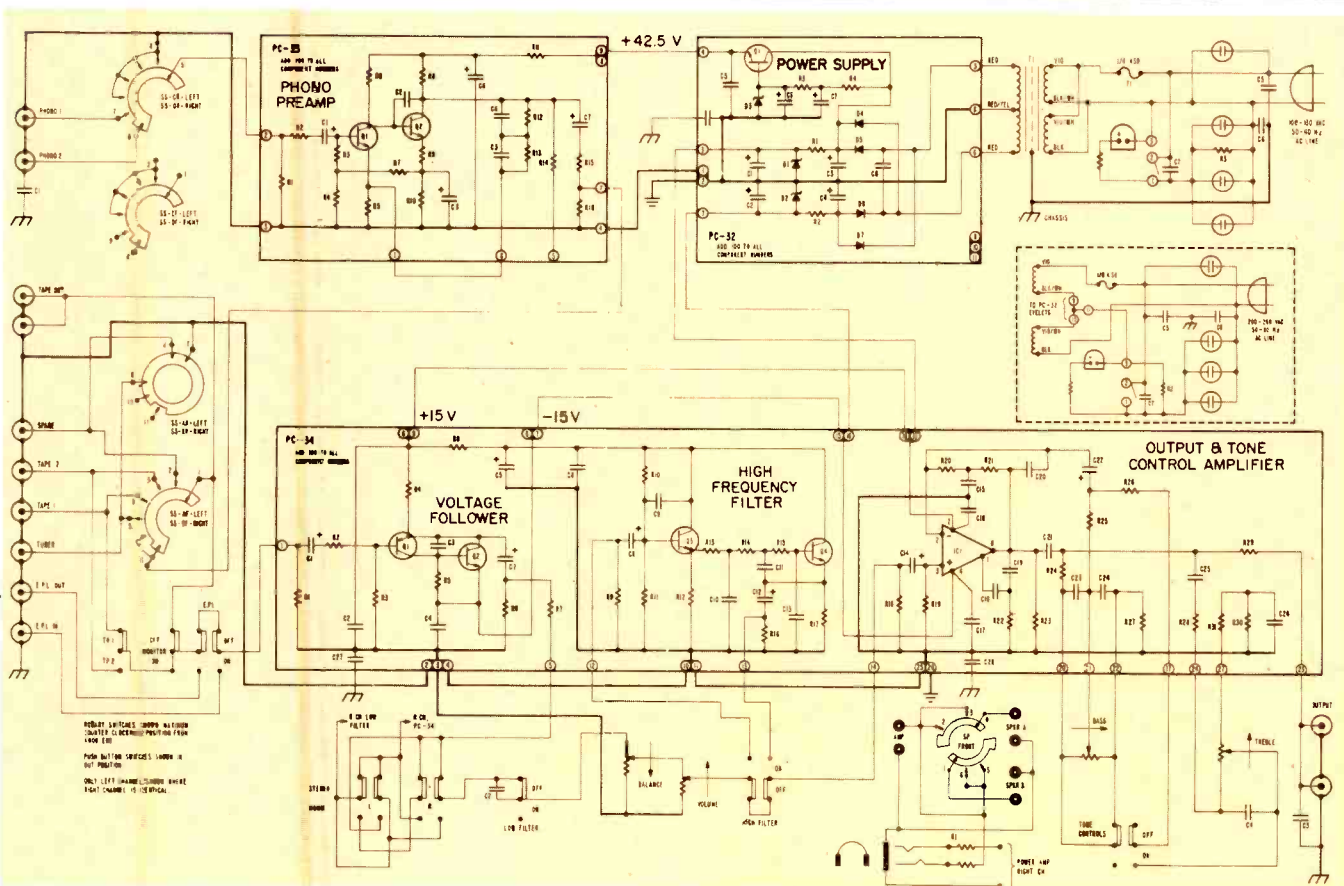

Fig. 4—Schematic diagram.

Section	No. Steps	Time, mins.
Back Panel Asmby.	45	135
Front Panel Asmby.	50	160
Selector Switch Asmby.	19	85
Audio Circuit Bd. Asmby.	60	100
Power Supply Asmby.	14	40
Final Asmby.	41	200
Total	229	11 hrs., 20 mins.

Because I made a couple of mistakes when I assembled the ST-400, I was especially careful in wiring the PAT-5. Either because it's a simpler kit or perhaps because I was more careful with this kit, it worked perfectly the first time I connected it to the system. If there'd been trouble, however, I probably would have been able to clear it up by using the information in the four pages of troubleshooting aids Dynaco supplied in the manual. These include pictorial layouts of the components on each board, with voltage tables for each board and for each transistor, diode, and the two ICs.—Charles Graham.

### Phono Preamp Measurements

Gain of the phono preamp at 1kHz measured 78X and 74X in the left and right channels respectively, which works out to 37.8 and 37.4 dB. Input noise with shorted inputs in a 400Hz to 20kHz band was 0.26  $\mu$ V for left and right channels and with the measurement bandwidth extended to 20 Hz to 20 kHz band was 0.6 and 0.7  $\mu$ V for both channels. The 20 Hz to 20kHz noise was largely "1/f" or lower frequency noise and was relatively free of 60 Hz line harmonics. These are excellent noise figures and represent a phono signal-to-noise ratio of 83 to 84 dB below 10 mV at 1 kHz.

The 20 kHz THD, standard SMPTE IM, and CCIF IM for equal amplitude 10 and 11 kHz output levels are plotted in Fig. 5 vs. phono preamp rms output level. The data shown is for a high impedance measurement load at the tape-out-

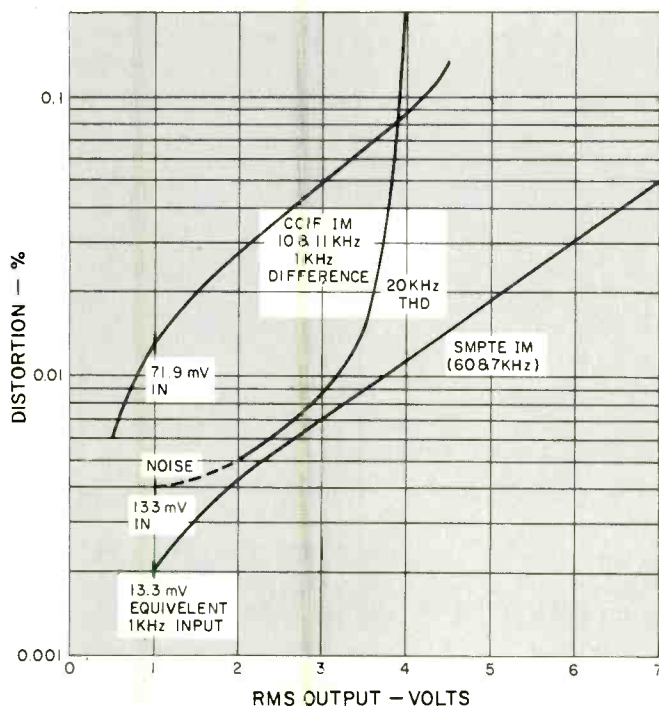

Fig. 5—Output voltage vs. CCIF and SMPTE IM and 20-kHz THD.

jacks of the preamp. This presents the normal load to the *phono preamp* output, which is the 50-kOhm input impedance of the voltage follower. Loading the phono preamp output with 10kOhms increased all the distortion levels somewhat and reduced the maximum output before clipping, which can be seen most easily in the phono overload measurements shown in Table 1.\* Standard SMPTE IM is quite low up to 7 V output. The 20-kHz THD is low up to about 3.5 volts and then climbs rapidly beyond 4 V. This rapid increase in THD above 4 V output is caused by the relatively low impedance reactive load of the RIAA feedback network upon the output stage of the phono circuit. Since the impedance of this network decreases with increasing frequency, it becomes more difficult for the output stage to swing to the lower frequency, lightly loaded voltage clipping level. This distortion in the region of rapid increase with output level is mainly even harmonic due to the output stage cutting off on the plus half cycle of the output voltage waveform. Since, due to the reactive nature of the load, the transistor output current is out of phase by some 60 to 80 degrees with the output voltage, the current cuts off when the output voltage goes past zero on the way to the positive peak of the sine wave. When this happens, the output transistor has lost control of the situation and the collector load resistor continues to pull the output positive but in a non-sinusoidal manner. This same effect causes first-order difference tone generation in the CCIF IM test.

All of the above simply means that the output voltage deliverable at low distortion decreases as frequency increases. This is not unique with the PAT-5 phono preamp but is characteristic, more or less, of all the two-stage, feedback-equalized phono preamps on the market. More sophisticated complementary output stage circuits can reduce this kind of \*Dynaco specifies 15 kOhms as the load.

Table 1—Frequency and load vs. phono overload. Dynaco specifies 15 kOhms as the load.

Frequency, Hz	Input, millivolts		Output, volts	
	Hi-Z Load	10-kOhm Load	Hi-Z Load	10-kOhm Load
20	15.8	12.5	11.0	5.7
100	30.2	19.8	11.0	6.0
1k	132	83	10.0	5.6
5k	298	202	8.8	5.4
10k	420	320	6.7	4.7
20k	540	480	4.3	3.5

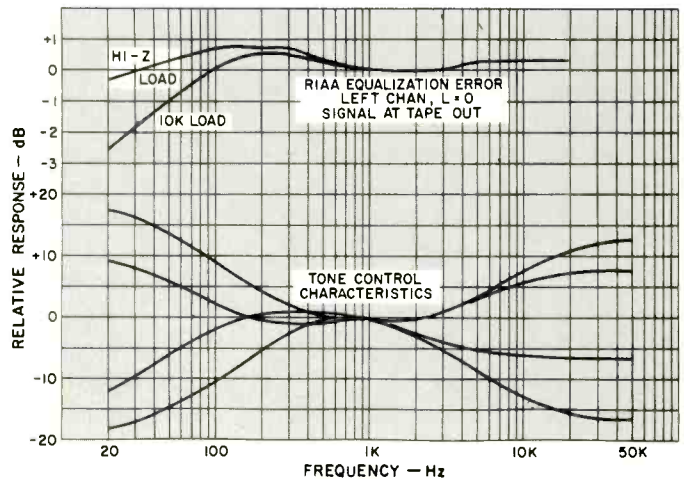

Fig. 6—RIAA equalization error and tone control characteristics. Dynaco specifies 15 kOhms as the load.

distortion but don't necessarily sound better. The Dyna PAT-5 phono stage has enough high frequency input signal acceptance to not be in trouble with most all high-quality magnetic cartridges.

RIAA equalization error with a noninductive source is shown in Fig. 6. The broad rise between 50 and 500 Hz in the left channel plotted is enough to be audible as a slight upper bass heaviness. The right channel was considerably flatter in this region. The low-frequency rolloff with 10 kOhm loading is mainly due to the relatively small 1  $\mu$ F output coupling capacitor. The effect of nonideal 47-kOhm input resistance and possible interaction of reactive sources on the feedback equalization was checked using representative low- and high-inductance cartridges. With the high-inductance cartridge source, the response was found to rise with frequency being up about 0.8 dB at 5 kHz, +1.6 dB at 10 kHz, +1.8 dB at 15 kHz, and +1.6 dB at 20 kHz. This is in contrast to other preamps tested which have tended to roll off the last octave by 1 to 2 dB. This characteristic would tend to make the PAT-5 sound slightly brighter than other preamps when using most magnetic cartridges which are high inductance types. With the low-inductance source, the effect was much less pronounced and more like other preamps tested which, in general, tend to be up 0.3 to 0.6 dB from 3 to 20 kHz.

Phono overload vs. input frequency is shown in Table 1 below for an open circuit and 10-kOhm load at the tape-out jacks. Overload was judged visually on a scope and was either onset of peak clipping at low frequencies or the positive slope distortion at high frequencies discussed under distortion observations.

Scope photos of pre-equalized square waves are illustrated in Fig. 8 for test frequencies of 40 Hz, 1 kHz, and 10 kHz. The rise time of the input signal is limited to 7  $\mu$ s to give an equivalent input bandwidth of 50 kHz. With a 10-kOhm load, the low-frequency tilt shown for 40 Hz about doubled.

Channel-to-channel crosstalk of the phono preamp was measured on a pre-equalized basis and found to be down 80 dB or more from 100 Hz to 5 kHz, decreasing to -49 dB at 20 Hz and -68 dB at 20 kHz. These are quite good measurements for this test.

### Output Section Measurements

Except where otherwise noted, the measurements of the output section are made with the filters and tone controls switched out. Signal input was into *Tuner*, output taken at main output with volume control at maximum.

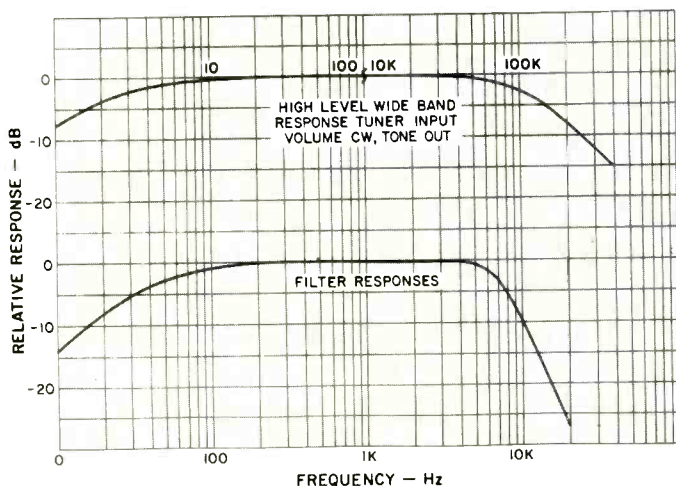

Fig. 7—Filter responses (lower curve) and high-level response (upper curve; note break at 100 Hz/10 kHz).

Output section voltage gain was found to be 9.8X and 10.2X for left and right channels respectively, which works out to 19.8 and 20.2 dB. IM distortion was low indeed, being less than 0.002 per cent for output levels of 7 V rms or below, with load resistances of 10 kOhms or higher. Harmonic distortion was also very low, being less than 0.01 per cent for 20 Hz to 20 kHz at rated output of 2 V rms with a 10-kOhm load or higher. THD was highest at 20 kHz and was just under 0.01 per cent. At 9 V rms output with a 10-kOhm load, THD was still under 0.01 per cent from 20 Hz to 10 kHz and was 0.025 per cent at 20 kHz. To get an idea of how low THD really was at mid frequencies, a wave analyzer was used to measure the distortion products at 2 V output at 1 kHz with a 10-kOhm load. The technique is to feed the wave analyzer from the distortion output of the Sound Technology 1700A THD meter. This keeps the fundamental out of the wave analyzer, reducing its own spurious responses to very low values and extends the percentage measurement range to the residual of the Sound Tech oscillator. This measurement yielded 0.0005 per cent second, 0.0005 per cent third, 0.00013 per cent fourth, and less than 0.0001 per cent fifth. Extremely low measured distortion levels to say the least!

High-level frequency response, along with filter responses, are plotted in Fig. 7. Tone control characteristics for maximum boost and cut and for boost and cut settings of plus and minus 6 dB at 50 and 19 kHz are shown in Fig. 6. The characteristics of this type of tone-control circuit are nicely revealed here, showing that the turnover frequency for bass boost and cut is clearly variable with amount of control rotation and that the treble turnover frequency is lower for cut than boost.

A comment is in order here on the relation between mechanical and electrical center of the tone control pots. This type of circuit is sensitive to the accuracy of 10 per cent resistance at 50 per cent rotation in the control pots and to the tolerance in the associated resistors and capacitors. It was noticed that this factory wired unit didn't have equal rotation of the tone control knobs on either side of center, i.e. the knobs were adjusted on the shafts so that the response was flat with the tone controls engaged and the slots in the

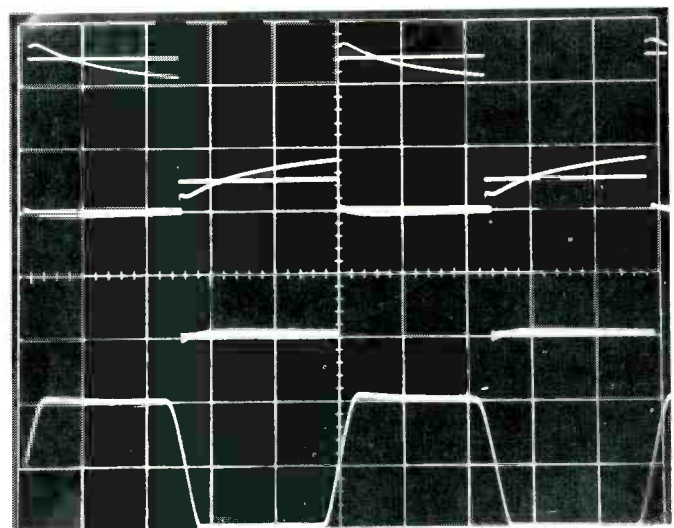

Fig. 8—Pre-equalized square-wave responses from phono preamp. Top, 40 Hz; middle, 1 kHz; bottom, 10 kHz. (All outputs, 0.5 V/cm; inputs adjusted to overlay outputs; top, 5 mS/cm; middle, 200  $\mu$ S/cm; bottom, 20  $\mu$ S/cm.)

knobs were at 12 o'clock. The kit instructions\* tell the builder to put the knobs on so that the amount of mechanical rotation is equal on either side of center. When that was done with this unit, response was down 3 dB at 20 Hz and 2 dB down at 10 kHz. The effect of this on a 100-Hz square wave is shown in the middle trace of Fig. 9. If the kit builder wants flattest response with the tone controls engaged and knobs set at 12 o'clock, it would be wise to use an a.c. VTVM and oscillator and set the shafts for flattest response and then put the knobs on with slots straight up. Square-wave response at 20 Hz and 20 kHz is shown in Fig. 9. The 20-Hz tilt with a 10-

kOhm or higher load was about the same, a good feature especially when driving a 10-kOhm input impedance power amplifier.

\*Ed. note: Dynaco tells us that the first kit manuals were in error on this point. Subsequent printings describe approximate knob positioning correctly, so the knob rotates clockwise from 6 o'clock to 4 o'clock.

Output noise vs. bandwidth and volume control rotation is in Table 2. The higher noise level in the 20-Hz to 20-kHz measurement bandwidth was mainly due to line harmonics. Switching the high-cut filter in caused the 20 Hz to 20 kHz noise to be 75 and 72  $\mu$ V in left and right channels respectively and was dominantly a high-frequency hiss increase due to the added noise of the filter amplifier. These output noise levels are in the area of possible audibility at the speakers if the speakers are high efficiency and the power amplifier used has higher than usual (28-32 dB) voltage gain.

Channel-to-channel crosstalk in the output section was measured and found to be greater than 80 dB down from 20-1500 Hz, decreasing to -70 dB at 4 kHz, -60 dB at 12 kHz, and -56 dB at 20 kHz.

In summary, the Dynaco PAT-5 offers good sonic performance and control features and would appear to be a good value for the money, especially if purchased as a kit. —Bascom H. King

Check No. 93 on Reader Service Card

**Table 2**—Output section noise vs. volume control rotation and bandwidth.

Bandwidth, Hz	Left Output, $\mu$ V			Right Output, $\mu$ V		
	CCW	WC	CW	CCW	WC	CW
400-20K	38	41	40	38	40	39
20-20k	62	74	74	46	49	49

Notes: CCW is counterclockwise; WC is worst case, usually about 6 dB down from maximum position, and CW is clockwise.

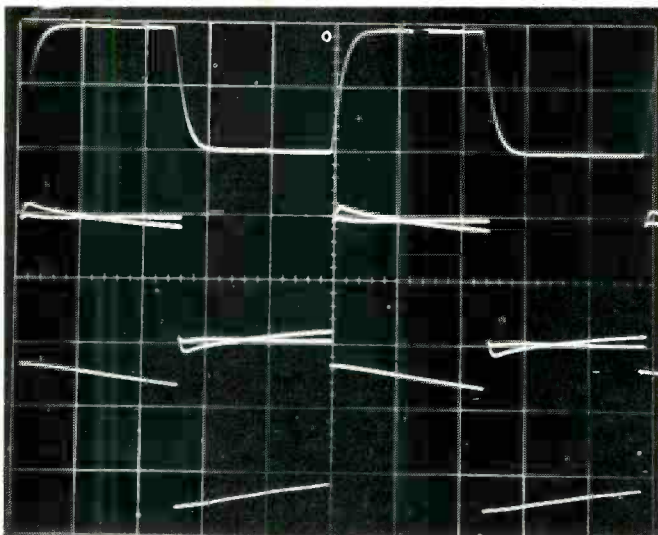

**Fig. 9**—Square-wave response of the output section. Top, 20 kHz, filters and tone controls out; middle, 1 kHz, tone controls electrically and mechanically centered; bottom, 20 Hz, filters and tone controls out. (Scales: top, 20  $\mu$ S/cm, 1 V/cm; middle, 200  $\mu$ S/cm, 1 V/cm; bottom, 10  $\mu$ S/cm, 1 V/cm.)



**Pioneer PL-71**  
Direct Drive Turntable

#### MANUFACTURERS SPECIFICATIONS

**Speeds:** 33-1/3 and 45 rpm. **Wow and Flutter:** 0.05% (WRMS) or less. **Rumble:** Better than 60 dB. **Platter:** 31 cm., aluminum alloy. **Effective Arm Length:** 224 mm. **Tracking Error:** +3, -1 deg. **Usable Cartridge Weight:** 4 to 32 gms. **Dimensions:** 18-7/8 in. W. x 16 in. D. x 7 1/4 in. H. **Weight:** 24 lbs. 4 oz. **Price:** \$299.95.

The Pioneer PL-71 is one of the most elegant, professional looking turntables we have yet tested, and its performance is top rate, as we will see later. Unlike most units, the motor panel is made of wood. The controls are all located on a handsome metal subpanel mounted on the right-hand side. From the front, there are three push-buttons for on/off, 33-1/3 or 45 rpm; then come two small rotary controls for speed variation (one for each speed) and, next to the arm base, is a long cue lever. The arm itself is a beautifully made S-type with counterweights, and there are adjustments for anti-skating, stylus force, lateral balance, arm height, and overhang. The anti-skating control is mounted on an extension to the arm base and is calibrated 0 to 4 grams, as is the tracking force dial. This is in the form of a ring on the rear of the tone arm (see Fig. 1). The reference mark is on the tone arm, and the dial is set to zero until the arm is balanced in the usual manner. The lateral balance is a little unusual, consisting of an angled bar fixed to the arm just in front of the



pivot. A weight is placed on the end and a set-screw locks the bar on the arm so that no further adjustment is required. The cartridge shell is held by a quick-release collar, and the cartridge is positioned for optimum overhang by using a gauge which doubles as the 45-rpm adaptor.

The motor is a d.c. servo type, direct-coupled to the turntable spindle so there is no belt, idler wheel or gears. It is driven by a single power transistor in a feedback circuit working at about 30 volts. The 3-lb. platter has strobe markings on the rim, and illumination is provided by a neon tube called a *strobe-light* which is mounted at the front left corner. Direct-drive systems have inherently low wow and flutter, while the servo control helps to maintain long term stability. The motor and pickup arm are not spring mounted, but acoustic feedback is prevented by elaborate shock absorbers built into the four mounting feet.

### Measurements

No trouble was experienced in mounting the phono cartridge which was my standard Shure V-15 III. Balancing and setting the other adjustments are fully described in the well-illustrated instruction manual so that even an absolute beginner should have no difficulty. The first test for wow and flutter measured a shade over 0.05% using the DIN standard. Rumble was exceptionally low at -65 dB ARRL. Speed variation was +4 to -3.5% at 45 rpm and +3 to -3.6% at 33-1/3. No change was detected when the line voltage was varied between 90 and 130 volts—a tribute to the servo system. (Incidentally, the PL-71 works just as well on a 50-Hz supply—no capstan or other change is necessary. There are connections for 200 to 240 volt operation.) The stylus force gauge was extremely accurate—certainly within 3%—and arm resonance with the Shure V-15 III came out at just under 8 Hz with a negligible 3-dB rise. Lateral and vertical bearing friction was too low to be measured accurately, and tracking error was less than 0.5 degrees per inch. Cable capacitance was found to be less than 100 pF, so some of the tests were made with a CD-4 cartridge, an Audio-technica AT-20.

### Use Tests

The PL-71 was used for several weeks, mainly with CD-4 records, and I must say I was very impressed. I *did* miss an automatic stop, but apart from that I have no criticisms to make. Optimum tracking force for the Audio-technica AT-20 was 1 1/4 grams and just over 1 gram for the Shure V15 Mk

III. Actually, many records could be played at under one gram but I invariably adjust for the difficult ones or use the Shure test disc. Many people do not realize that too low a tracking force can do as much damage as one that is too high! What about the anti-skating control? Well, optimum position was found to be a little higher than the tracking force but it was not unduly critical. The cue lift is nicely damped with no sideplay, and all the controls worked smoothly. Once the speed control was set, no readjustment was necessary—the speed remained constant—right on the nose. The motor itself is exceptionally quiet, and taken all round, I would put the PL-71 in the highest class—even the most fastidious audiophile will not be disappointed.

George W. Tillett

Check No. 94 on Reader Service Card

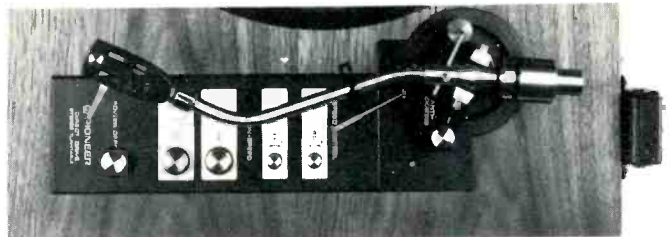

Fig. 1—Close-up of arm.

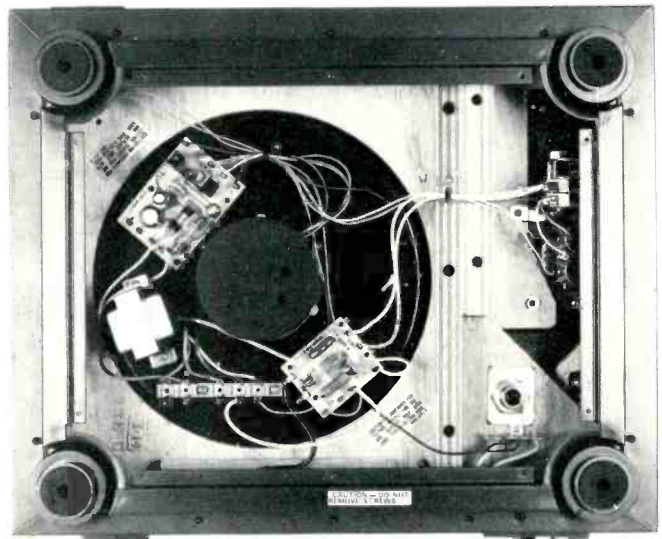

Fig. 2—View from beneath.

