

Operating Instructions

STEREO AMPLIFIER SA-1040

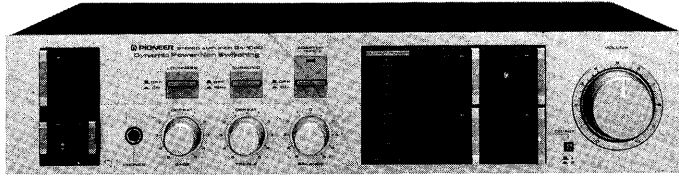

Thank you for buying this Pioneer product. Please read through these operating instructions and then you will know how to operate your model properly. After you have finished reading the instructions, put them away in a safe place for future reference.

These operating instructions are based on the model KU, and they can be used for the KC, YP, S and S/G models. The differences between the models are given below.

KU and KC models:

For U.S.A. and Canada ('KU' or 'KC' stamped on packing case): power line voltage is AC 120 volts.

YP model:

For Australia ('YP' stamped on packing case): power line voltage is a.c. 240 volts ~.

S and S/G models:

For destinations excluding above ('S' or 'S/G' stamped on packing case): A 4-point (a.c. 110 V/120 V/220 V/240 V) voltage selector switch is provided.

IMPORTANT NOTICE [For KU and KC models]

The serial number for this equipment is located on the rear panel. Please write this serial number on your enclosed warranty card and keep in a secure area. This is for your security.

The KU and KC models do not have a LINE VOLTAGE SELECTOR, therefore power line voltage cannot be changed.

LINE VOLTAGE SELECTOR SWITCH

Only S and S/G models are provided with this switch but KU, KC and other model YP are not provided with this switch

You will find the line voltage selector switch on the rear panel. This switch has positions for 110 V, 120 V, 220 V and 240 V power sources. Before your model is shipped from the factory, the switch is set to the power requirements of the destination; nevertheless, you should check that it is set properly before plugging the power cord into the AC outlet. If the voltage is not properly set or if you move to an area where the voltage requirements differ, adjust the selector switch as follows. Before adjusting disconnect the power cord.

1. Prepare a medium size screwdriver.
2. Insert the screwdriver into the arrow on the voltage selector and adjust so that the tip of the arrow points to the voltage value of your area.

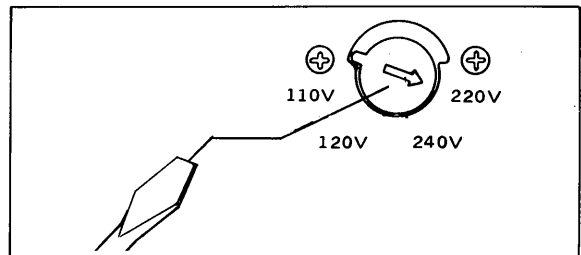

WARNING: TO PREVENT FIRE OR SHOCK HAZARD, DO NOT EXPOSE THIS APPLIANCE TO RAIN OR MOISTURE.

CONTENTS

Rear Panel Facilities and Connections	3	Operation	8
Connection Diagram	4	Using a Tape Deck	9
Power Cord Connection	5	Troubleshooting	10
Front Panel Facilities	6	Specifications	11

SAFETY INSTRUCTIONS [FOR KU MODEL]

READ INSTRUCTIONS — All the safety and operating instructions should be read before the appliance is operated.

RETAIN INSTRUCTIONS — The operating instructions should be retained for future reference.

HEED WARNING — All warnings on the appliance and in the operating instructions should be adhered to.

FOLLOW INSTRUCTIONS — All operating and use instructions should be followed.

WATER AND MOISTURE — The appliance should not be used near water — for example, near a bathtub, washbowl, kitchen sink, laundry tub, in a wet basement, or near a swimming pool, etc.

LOCATION — The appliance should be installed in a stable location.

WALL OR CEILING MOUNTING — The appliance should not be mounted to a wall or ceiling.

VENTILATION — The appliance should be situated so that its location or position does not interfere with its proper ventilation. For example, the appliance should not be situated on a bed, sofa, rug, or similar surface that may block the ventilation openings; or, placed in a built-in installation, such as a bookcase or cabinet that may impede the flow of air through the ventilation openings.

HEAT — The appliance should be situated away from heat sources such as radiators, heat registers, stoves, or other appliances (including amplifiers) that produce heat.

POWER SOURCES — The appliance should be connected to a power supply only of the type described in the operating instructions or as marked on the appliance.

POWER-CORD PROTECTION — Power-supply cords should be routed so that they are not likely to be walked on or pinched by items placed upon or against them, paying particular attention to cords at plugs, convenience receptacles, and the point where they exit from the appliance.

CLEANING — The appliance should be cleaned only with a polishing cloth or a soft dry cloth. Never clean with furniture wax, benzine, insecticides or other volatile liquids since they may corrode the cabinet.

POWER LINES — An outdoor antenna should be located away from power lines.

NONUSE PERIODS — The power cord of the appliance should be unplugged from the outlet when left unused for a long period of time.

OBJECT AND LIQUID ENTRY — Care should be taken so that objects do not fall and liquids are not spilled into the enclosure through openings.

DAMAGE REQUIRING SERVICE — The appliance should be serviced by Pioneer authorized service center or qualified service personnel when:

- The power-supply cord or the plug has been damaged; or
- Objects have fallen, or liquid has been spilled into the appliance; or
- The appliance has been exposed to rain; or
- The appliance does not appear to operate normally or exhibits a marked change in performance; or
- The appliance has been dropped; or the enclosure damaged.

SERVICING — The user should not attempt to service the appliance beyond that described in the operating instructions. For all other servicing, contact the nearest Pioneer authorized service center.

OUTDOOR ANTENNA GROUNDING — If an outside antenna is connected to the antenna terminal, be sure the antenna system is grounded so as to provide some protection against voltage surges and built up static charges.

In the U.S.A. section 810 of the National Electrical Code, ANSI/NEPA No. 70-1981, provides information with respect to proper grounding of the mast and supporting structure, grounding of the lead-in wire to an antenna discharge unit, size of grounding conductors, location of antenna-discharge unit, connection to grounding electrodes, and requirements for the grounding electrode. See Fig. A.

EXAMPLE OF ANTENNA GROUNDING AS PER NATIONAL ELECTRICAL CODE INSTRUCTIONS

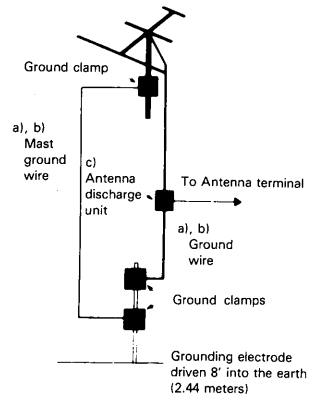

Fig. A

- a) Use No. 10 AWG (5.3 mm²) copper or No. 8 AWG (8.4 mm²) aluminum or No. 17 AWG (1.0 mm²) copper-clad steel or bronze wire, or larger as ground wires for both mast and lead-in.
- b) Secure lead-in wire from antenna to antenna discharge unit and mast ground wire to house with stand-off insulators, spaced from 4 feet (1.22 meters) to 6 feet (1.83 meters) apart.
- c) Mount antenna discharge unit as closely as possible to where lead-in enters house.

IMPORTANT [FOR KU MODEL]



The lightning flash with arrowhead, within an equilateral triangle, is intended to alert the user of the presence of uninsulated "dangerous voltage" within the product's enclosure that may be of sufficient magnitude to constitute a risk of electric shock to persons.



CAUTION:
TO PREVENT THE RISK OF ELECTRIC SHOCK, DO NOT REMOVE COVER (OR BACK). NO USER-SERVICEABLE PARTS INSIDE. REFER SERVICING TO QUALIFIED SERVICE PERSONNEL.



The exclamation point within an equilateral triangle is intended to alert the user of the presence of important operating and maintenance (servicing) instructions in the literature accompanying the appliance.

IMPORTANT

To prevent electric shock, do not remove cover. No user serviceable parts inside, refer servicing to qualified service personnel. Always disconnect all the equipment from the mains supply when disconnecting the signal leads. The power cord should be connected last, make sure that the power switch is off. Unplug the set from the wall socket when it is not to be used for an extended period of time.

FOR USE IN UNITED KINGDOM AND AUSTRALIA

CAUTION 240 V: Mains supply voltage is factory adjusted at 240 V.

FOR USE IN UNITED KINGDOM

The wires in this mains lead are coloured in accordance with the following cord:

Blue: Neutral
Brown: Live

As the colours of the wires in the mains lead of this apparatus may not correspond with the coloured marking identifying the terminals in your plug proceed as follows:

The wire which is coloured blue must be connected to the terminal which is marked with the letter N or coloured black.

The wire which is coloured brown must be connected to the terminal which is marked with the letter L or coloured red.

Equipment sold in the U.K. is not supplied with a power plug.

REAR PANEL FACILITIES AND CONNECTIONS

For connecting the ground wire of the turntable

A second tape deck or an adaptor can be connected here.

Connect the headphone cord of the rack here when the rack is provided with a PHONES jack.

For connecting a tape deck

For connecting the speakers

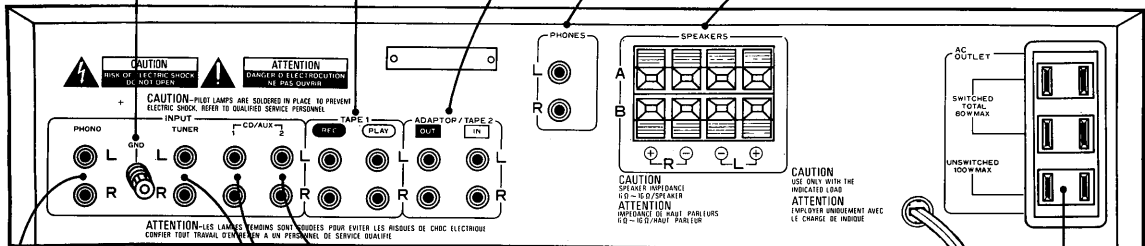

For connecting the output cords of a turntable

A compact disc player or other stereo component can be connected here.

AC outlets

For connecting the tuner's output terminals with a pin cord

A TV tuner or other stereo component can be connected here.

CONNECTING THE SPEAKER CORDS

- 1 Peel off the vinyl covering and twist the ends together.
- 2 Push the lever and insert the cord into the opening.

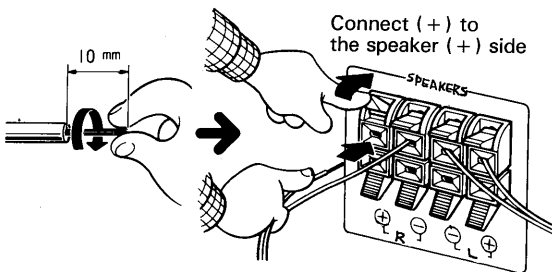

Connect (+) to the speaker (+) side

Connect (-) to the speaker (-) side

Release the lever and pull the cord to see that it is connected properly and securely.

SPEAKER IMPEDANCE

Use speaker systems with an impedance ranging from 6 to 16 ohms. When connecting two pairs of speaker systems for simultaneous use, select models with an impedance of between 6 and 16 ohms. Make a note of the allowable input of a speaker system which is not a model specially designed for this amplifier.

AC OUTLETS

Plug the power cords of the stereo components into these outlets.

These are coupled to the ON/OFF operations of the amplifier's power switch and the power is switched ON or OFF by this switch.

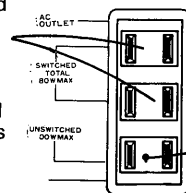

This is not coupled to the amplifier's power switch and is the same as any ordinary outlet.

AC OUTLETS (SWITCHED)

Power supplied through these outlets is turned on and off by the amplifier's POWER switch. Total electrical power consumption of connected equipment should not exceed 80 W

AC OUTLET (UNSWITCHED)

Power flows continually to this outlet, regardless of whether the amplifier is switched ON or OFF. Electrical power consumption of the connected equipment should not exceed 100 W.

The equipment should be disconnected by removing the mains plug from the wall socket when not in regular use, e.g. when on vacation.

NOTE:

Do not connect appliances with high power consumption such as heaters, irons, or television sets to the AC OUTLETS in order to avoid overheating or fire risk. This can cause the amplifier to malfunction.

CONNECTION DIAGRAM

First, try to see the entire connection configuration.

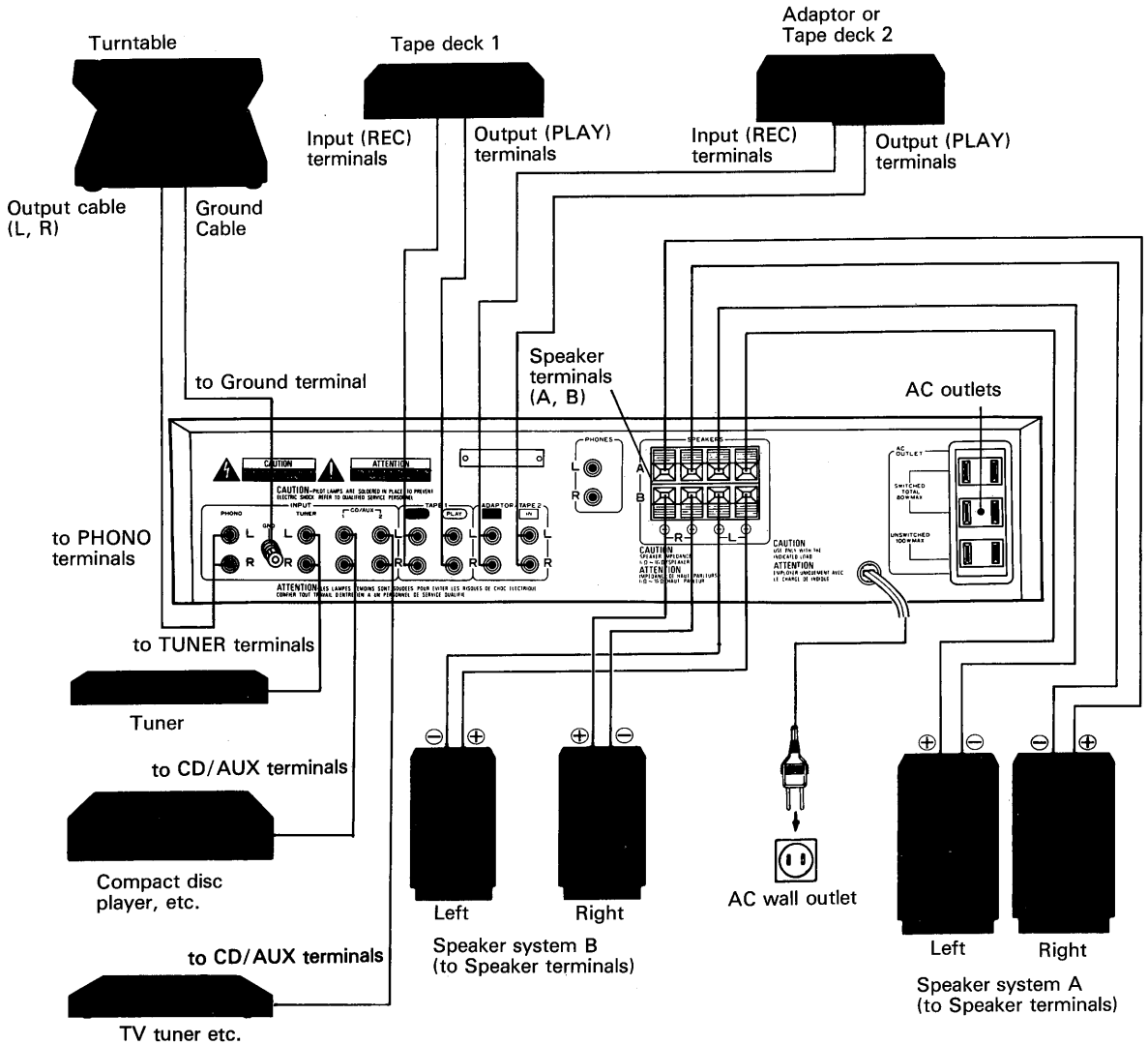

POWER CORD CONNECTION

This figure showing the power cord connection for the stereo system gives an example to follow when the unit is used in combination with PIONEER's stereo components.

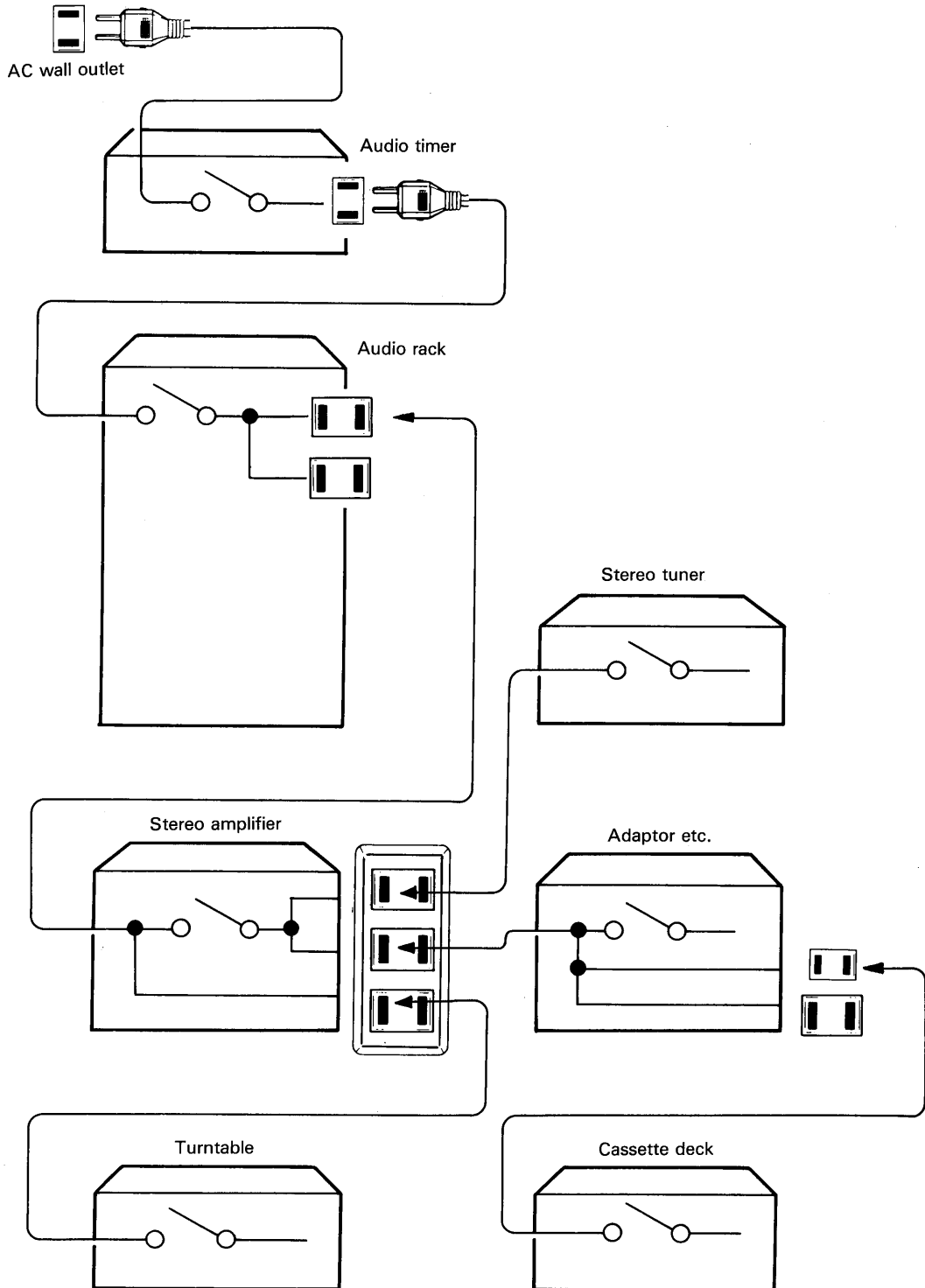

FRONT PANEL FACILITIES

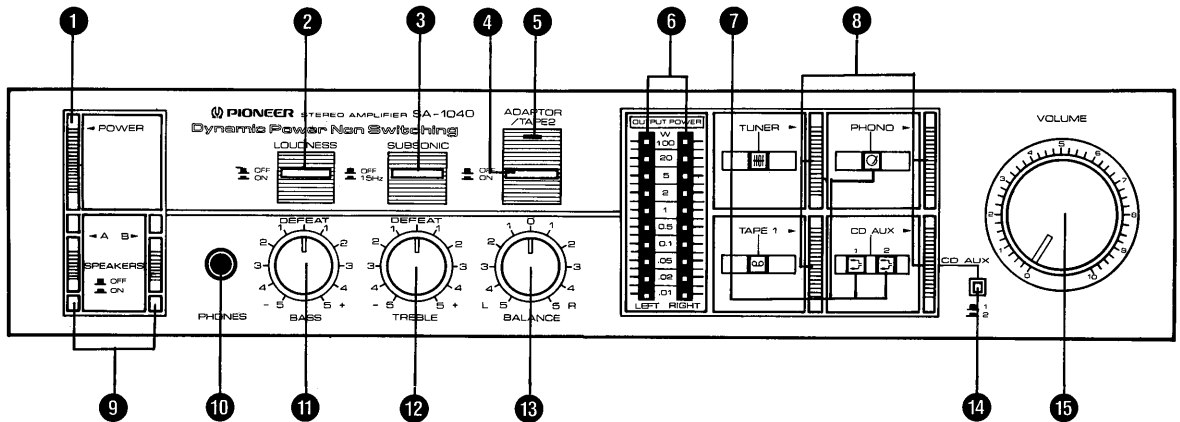

1 POWER SWITCH

When this switch is pressed, the power is supplied (the function indicators light). When it is pushed again, the power is switched off.

2 LOUDNESS SWITCH

Push this switch to the "ON" position for low-volume sound listening. The bass and treble are emphasized and you can sit back and listen to a dynamic sound even under low-volume conditions.

3 SUBSONIC FILTER SWITCH

The subsonic filter with the 15 Hz cutoff frequency is actuated when this switch is depressed to the 15 Hz (ON) position (the SUBSONIC indicator lights).

This filter serves to attenuate frequencies lower than 15 Hz with a 6 dB/oct slope and, therefore, it can be used to suppress the ultra-low-range noise which is generated by record warp and other factors. This noise cannot actually be heard by the ear but it can cause cross modulation distortion and even speaker damage. Use this switch when required during record play.

4 ADAPTOR/TAPE 2 SWITCH

This is used when operating an adaptor (such as a tape creating amplifier) or when playing back a tape in a tape deck connected to the rear panel ADAPTOR/TAPE 2 terminals.

5 ADAPTOR/TAPE 2 INDICATOR

This lights when the ADAPTOR/TAPE 2 switch is set to ON.

6 OUTPUT POWER INDICATORS

The left and right indicators show the output level (in watts) when a speaker system with an 8-ohm nominal impedance has been connected to the unit. "L" indicates the left channel output level and "R" the right channel.

7 FUNCTION INDICATORS

The indicator corresponding to the function switch which has been pushed lights. Each indicator has a symbol: "⊙" for PHONO, "⌘" for TUNER, "≡" for CD/AUX and "∞" for TAPE 1.

8 FUNCTION SWITCHES

PHONO: Used when playing records on a turntable connected to the rear panel PHONO terminals.

TUNER: Used when listening to broadcasts on the tuner connected to the rear panel TUNER terminals.

CD/AUX: Used when operating a TV tuner or compact disc player etc. connected to the rear panel CD/AUX terminals.

TAPE 1: Used when playing back tapes in the tape deck connected to the rear panel TAPE 1 terminals.

9 SPEAKER SELECTOR SWITCHES

Select the switch that corresponds to the speaker systems through which the sound is to be heard. When the switch is pressed, the sound is heard through the speaker systems selected.

A: The sound is heard from the speakers connected to the speaker A terminals on the rear panel.

B: The sound is heard from the speakers connected to the speaker B terminals on the rear panel.

No sound will be heard when SPEAKERS A and B switches are both released. This is the position at which the sound can be heard through the headphones.

NOTE:

No sound will be heard through the speakers when both the A and B switches are depressed if only one set of speakers has been connected to either the A or B SPEAKERS terminals.

10 PHONES JACK

Plug the headphones into this jack securely for private listening.

NOTE:

Make it a rule to turn down the volume before plugging in the headphones. A loud sound can hurt your ears.

11 BASS CONTROL

This is used to adjust the bass sound.

When rotated clockwise from the center DEFEAT position, the bass is emphasized; when rotated counterclockwise, the bass is attenuated.

12 TREBLE CONTROL

This is used to adjust the treble sound.

When rotated clockwise from the center DEFEAT position, the treble is emphasized; when rotated counterclockwise, the treble is attenuated.

13 BALANCE CONTROL

This is normally kept at the "0" position. It should be adjusted when the left/right stereo balance has become lopsided. Rotate the control to the left when the right channel sound is too loud; rotate it to the right when the left channel sound is too loud.

14 CD/AUX 1, 2 SELECTOR SWITCH

Use this to select the component which has been connected to the auxiliary (CD/AUX 1, 2) terminals on the rear panel.

15 VOLUME CONTROL

This is used to adjust the sound volume of the speakers and headphone. No sound will be heard when the control has been set to the "0" position. Rotate the control clockwise to increase the sound level.

OUTPUT POWER INDICATORS

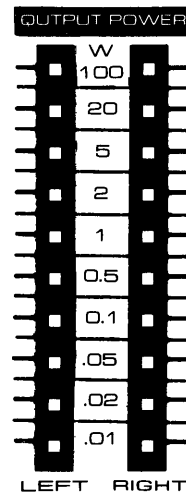

The output power indicators show the output level when speaker systems with a nominal impedance of 8 ohms have been connected to the rear panel speaker terminals. The output level (peak value) is indicated in watts by the scale units. Since a logarithmic compression scale is used, outputs ranging from the weak (0.01 W) to the strong (100 W) can be displayed without selecting the range.

During actual play the impedance of the speaker systems changes in accordance with the frequency. For this reason, the value indicated is not an exact representation of the output but only a rough guide.

OPERATION

Before starting any operation:

Set the controls and switches on the stereo amplifier as shown in the figure below.

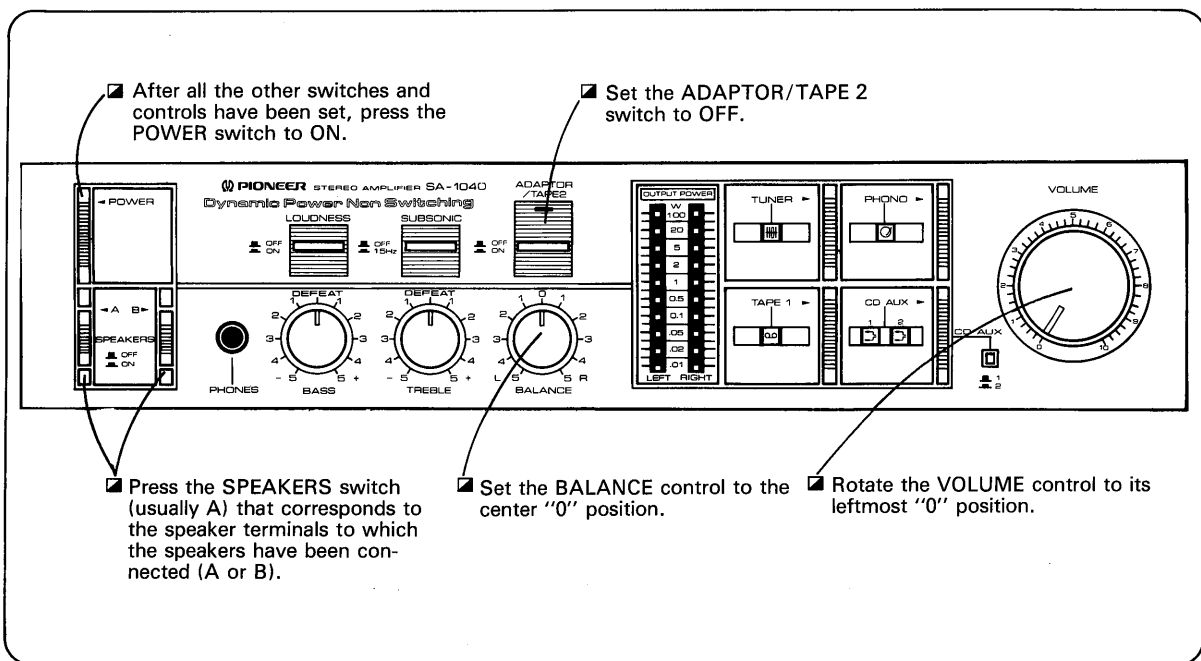

NOTE:

In order to protect the speakers, the power muting circuit is activated immediately after the power has been switched on and for about 3 seconds no sound is heard. The unit starts to function as soon as the muting circuit is released.

RECORD PLAY

- 1 Press the PHONO function switch.
- 2 Operate the turntable and place the record on the platter.
- 3 Start playing the record. Once the platter starts to rotate and the stylus descends onto the record, adjust the unit's volume with the VOLUME control.
For further details, refer to the Operating Instructions of the turntable concerned.
- 4 Adjust the sound quality to your preference using the bass and treble controls.

FM/AM RECEPTION

- 1 Press the TUNER function switch.
- 2 Tune in the station on the tuner.
- 3 Adjust the sound using the VOLUME control.
- 4 Adjust the sound quality to your preference using the bass and treble controls.

OPERATION OF COMPONENT CONNECTED TO CD/AUX TERMINALS

- 1 Press the CD/AUX function switch.
- 2 Press the CD/AUX switch (1 or 2) corresponding to the component connected to the rear panel auxiliary terminals (CD/AUX 1, 2).
- 3 Operate the component and start play.
- 4 Adjust the sound quality to your preference using the bass and treble controls.

USING A TAPE DECK

Tape Playback

- 1 Press the TAPE 1 function switch when a tape deck has been connected to the TAPE 1 terminals.
Press the ADAPTOR/TAPE 2 switch when a tape deck has been connected to the ADAPTOR/TAPE 2 terminals.
- 2 Set the tape deck to the playback mode.
- 3 Adjust the sound using the VOLUME control.
- 4 Adjust the sound quality to your preference using the bass and treble controls.

Tape Recording

- 1 Press the function switch corresponding to the program source to be recorded (PHONO, TUNER or CD/AUX) and check the sound (refer to page 8 for the procedure).
- 2 When the tuner, for instance, is in operation, the recording signals are sent from the tuner at the TAPE 1 and ADAPTOR/TAPE 2 REC terminals.
- 3 Start recording in accordance with the recording procedure of the tape deck.

Using a tape deck with a monitoring function (3-head system)

The recording can be monitored with this kind of tape deck through the speakers or headphones (when connected to the stereo amplifier's PHONES jack).

- Simultaneous monitoring is possible only with the ADAPTOR/TAPE 2 switch.

NOTE:

The recording cannot be monitored using a 2-head tape deck even if the ADAPTOR/TAPE 2 switch is operated. In this case, the sound is heard but this sound is from the program source before recording.

TROUBLESHOOTING

If you think that something has gone wrong with your unit, check out the points below before calling in the serviceman.

The cause of the trouble may lie in improper maintenance or operation. If the trouble is still not remedied even after the checks have been carried out, contact your nearest PIONEER service center.

Trouble	Possible cause	Remedy
No sound from speakers.	<ol style="list-style-type: none"> 1. POWER switch at OFF. 2. Disconnected power cord. 3. Minimum volume level. 4. Connecting cord has become disconnected from input terminal. 5. Speaker cord has become disconnected from output terminal. 6. ADAPTOR/TAPE 2 switch at ON. 7. Both A and B SPEAKERS SWITCHES have been depressed although two pairs of speaker systems, A and B, have not been connected. 	<ol style="list-style-type: none"> 1. Set switch to ON. 2. Plug into power outlet properly. 3. Rotate VOLUME control clockwise. 4. Connect pin plug securely. 5. Connect speaker cord properly. 6. Set switch to OFF. 7. Release the SPEAKER SWITCH corresponding to the rear panel SPEAKERS terminals which have not been connected to a speaker system.
No sound from one speaker.	<ol style="list-style-type: none"> 1. BALANCE control at leftmost or rightmost position. 2. One of speaker cords has become disconnected. 	<ol style="list-style-type: none"> 1. Set control to center position. 2. Connect cord securely.
No broadcast reception.	<ol style="list-style-type: none"> 1. Disconnected antenna connecting cord. 2. Antenna direction and height not adjusted properly. 3. Station not tuned in properly. 	<ol style="list-style-type: none"> 1. Connect antenna cord to terminal properly. 2. Install antenna in proper direction and at proper height. 3. Refer to Operating Instructions of tuner.
No record play heard.	<ol style="list-style-type: none"> 1. Tonearm is still in raised position. 2. Stylus not in position. 	<ol style="list-style-type: none"> 1. Operate arm and play record. 2. Insert stylus properly.
No recording.	<ol style="list-style-type: none"> 1. TAPE 1 function switch has been pushed. 2. Cassette tape's accidental erasure prevention tab broken out. 3. Disconnected connecting cord. 	<ol style="list-style-type: none"> 1. Press function switch corresponding to program source which is to be recorded. 2. Replace cassette tape or adhere piece of cellophane tape over opening where tab was broken out. 3. Connect cord properly. (Refer to CONNECTION DIAGRAM or POWER CORD CONNECTION on pages 4 and 5.)

SPECIFICATIONS

Amplifier Section

Continuous Average Power Output is 100 watts* per channel, min., at 8 ohms from 20 Hertz to 20,000 Hertz with no more than 0.007% total harmonic distortion.

Total Harmonic Distortion (20 Hertz to 20,000 Hertz, 8 ohms, from CD/AUX)

continuous rated power output No more than 0.007%
100 watts per channel power output

..... No more than 0.007%

Intermodulation Distortion (50 Hertz:7,000 Hertz = 4:1, 8 ohms, from CD/AUX)

continuous rated power output No more than 0.02%

Damping Factor

(1,000 Hertz, 8 ohms) 70

(20 Hertz to 20,000 Hertz, 8 ohms) 60

Input (Sensitivity/Impedance)

PHONO 2.5 mV/50 kilohms

TUNER, CD/AUX, TAPE PLAY, ADAPTOR IN

..... 150 mV/50 kilohms

Phono Overload Level (T.H.D. 0.1%, 1,000 Hz)

PHONO 200 mV

Output (Level)

TAPE REC, ADAPTOR OUT 150 mV

Speaker 6 — 16 Ω

Frequency Response

PHONO (RIAA Equalization)

..... 20 Hz to 20,000 Hz ± 0.2 dB

TUNER, CD/AUX, TAPE PLAY, ADAPTOR

..... 10 Hz to 100,000 Hz ± 3 dB

Tone Control

BASS ± 10 dB (100 Hz)

TREBLE ± 10 dB (10 kHz)

Subsonic Filter 15 Hz (-3 dB/oct.)

Loudness Contour (Volume control set at -40 dB position)

..... +6 dB (100 Hz), +3 dB (10 kHz)

Hum and Noise (IHF, short circuited A network)

PHONO 86 dB

TUNER, CD/AUX, TAPE PLAY, ADAPTOR IN

..... 106 dB

Miscellaneous

Power Requirements

KU, KC models AC 120 Volts, 60 Hz

S, S/G models

..... \sim AC 110 V/120 V/220 V/240 V (switchable) 50/60 Hz

YP model

..... a.c. 240 Volts \sim , 50 Hz

Power Consumption

KU, KC models 170 Watts (max.)

S, S/G models 230 Watts (max.)

YP model 700 Watts (max.)

Dimensions 420 (W) x 98 (H) x 327 (D) mm

16-9/16 (W) x 3-7/8 (H) x 12-7/8 (D) in

Weight (without package) 8.2 kg (18 lb 1 oz)

Furnished Parts

Operating Instructions 1

*Measured pursuant to the Federal Trade Commission's Trade Regulation rule on Power Output Claims for Amplifier.

NOTE:

Specifications and design subject to possible modifications without notice.

PIONEER ELECTRONIC CORPORATION 4-1, Meguro 1-Chome, Meguro-ku, Tokyo 153, Japan
PIONEER ELECTRONICS [USA] INC. 1925 E. Dominguez St., Long Beach, California 90810 U.S.A.
PIONEER ELECTRONIC [EUROPE] N.V. Keetberglaan 1, 2740 Beveren, Belgium
PIONEER ELECTRONICS AUSTRALIA PTY. LTD. 178-184 Boundary Road, Braeside, Victoria 3195, Australia

<83E01Y0S02>

Printed in Japan/Imprimé au Japon <ARB-543-A>