

A.G.Tannenbaum

Electronic Service Data

P.O. Box 386, Ambler PA 19002

Phone 215 657 0106 Fax 215 657 0520

Web Page www.agtannenbaum.com

PIONEER

MODEL SA-9100
AMPLIFIER

SERVICE MANUAL

STEREO AMPLIFIER **SA-9100** KUW, FVW

NOTE:

MODEL SA-9100 COMES IN TWO VERSIONS DISTINGUISHED AS FOLLOWS:

Round label on rear panel	Voltage	Type
KUW FVW	120V only 5-position selector	UL approved (U.S.A.) General export model

PIONEER®

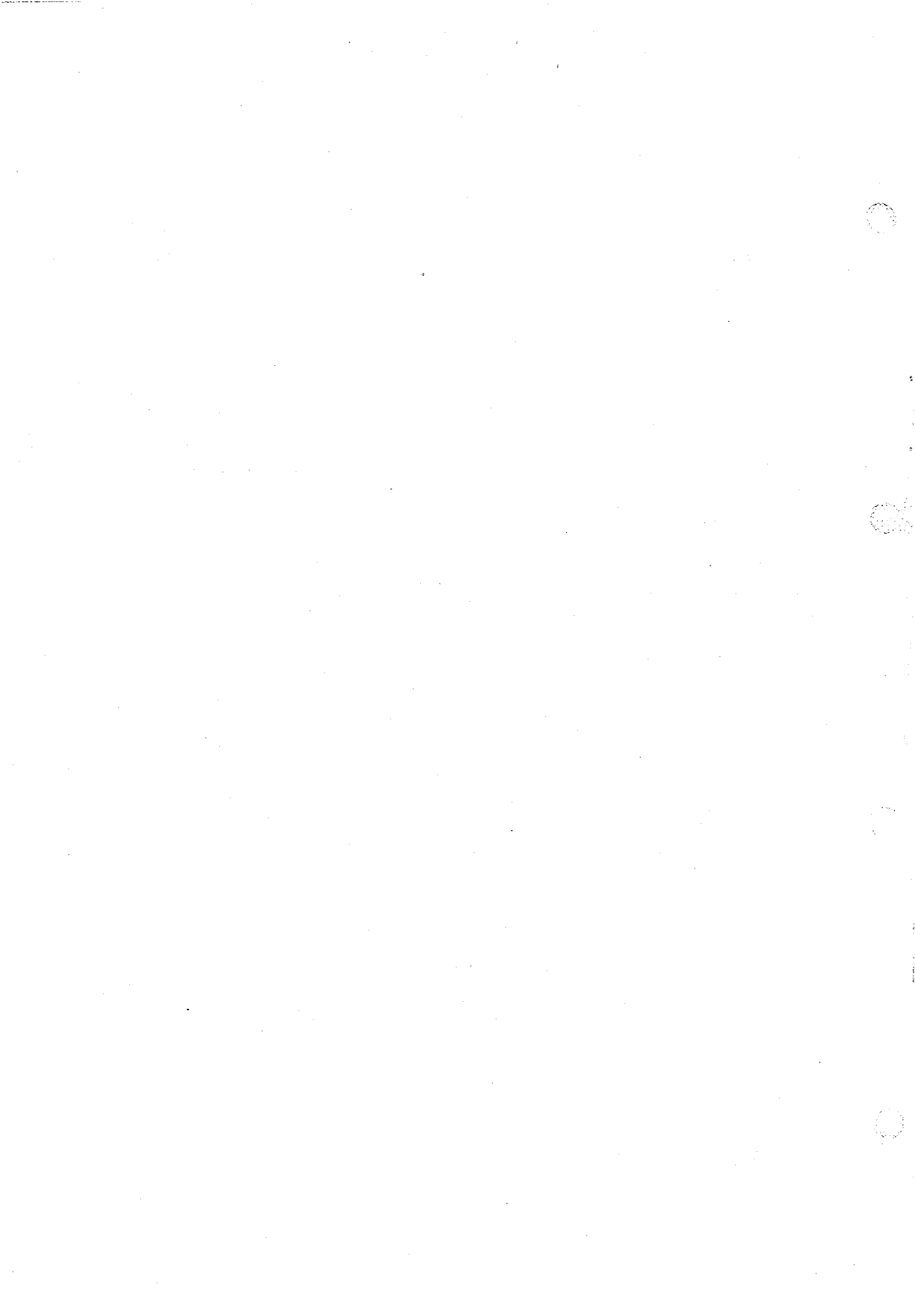

CONTENTS

1.	AMPLIFIER CHARACTERISTICS	2
2.	SPECIFICATIONS	3
3.	CONNECTION DIAGRAM	5
4.	FRONT PANEL FACILITIES	7
5.	BLOCK DIAGRAM	9
6.	CIRCUIT DESCRIPTION	
	6.1 Equalizer Amplifier	11
	6.2 Control Amplifier	11
	6.3 Filter Amplifier	12
	6.4 Power Amplifier	13
	6.5 Protection Circuit	14
	6.6 Power Supply Circuit	14
7.	DISASSEMBLY	15
8.	PARTS AND P.C. BOARD LOCATION	
	8.1 Top View	16
	8.2 Bottom View	17
9.	ALIGNMENT PROCEDURE	
	9.1 Idle Current Adjustment	18
	9.2 Adjustment of Neutral Potential	18
10.	EXPLODED VIEW AND PARTS LIST	19
11.	SCHEMATIC DIAGRAMS, P.C. BOARD PATTERNS AND PARTS LIST	
	11.1 Circuit Connection Diagram and Miscellaneous Parts	23
	11.2 Equalizer Amp Ass'y (AWF-007-0)	31
	11.3 Control Amp Ass'y (AWG-018-A)	33
	11.4 Filter Amp Ass'y (AWK-021-0)	37
	11.5 Power Amp Ass'y (AWH-023-B)	39
	11.6 Protection Circuit Ass'y (AWM-025-A)	43
	11.7 Power Supply Circuit-A Ass'y (AWR-031-0)	46
	11.8 Power Supply Circuit-B Ass'y (AWR-032-0)	48
	11.9 Switch-A Ass'y (AWS-038-0)	51
	11.10 Switch-B Ass'y (AWS-039-0)	52
	11.11 Switch-C Ass'y (AWS-040-0)	54
	11.12 Volume Ass'y (AWX-048-0)	56
12.	PACKING METHOD AND PARTS NUMBERS	57
13.	SKELETON APPEARANCES OF TRANSISTORS	58

1. AMPLIFIER CHARACTERISTICS

POWER BANDWIDTH

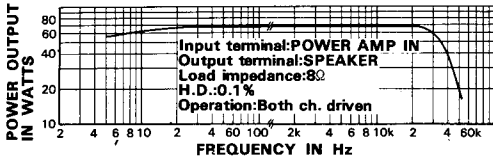

DAMPING FACTOR

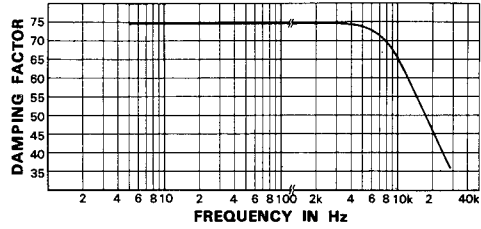

PHONO EQUALIZATION ACCURACY

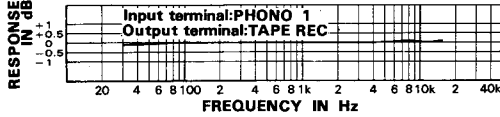

LOW AND HIGH FILTERS

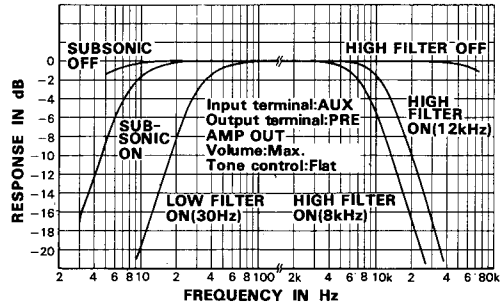

MAX. PHONO INPUT LEVEL

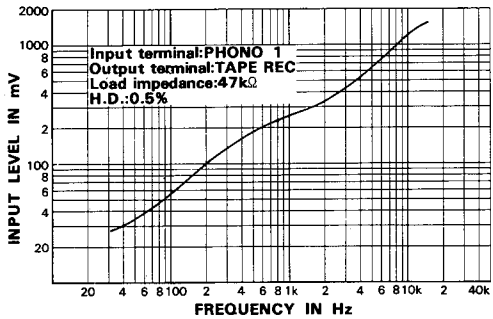

TWIN TONE CONTROLS (MAIN)

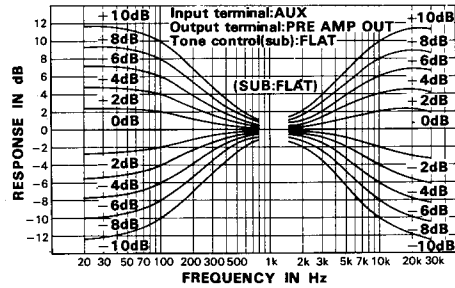

OUTPUT POWER vs. HARMONIC DISTORTION

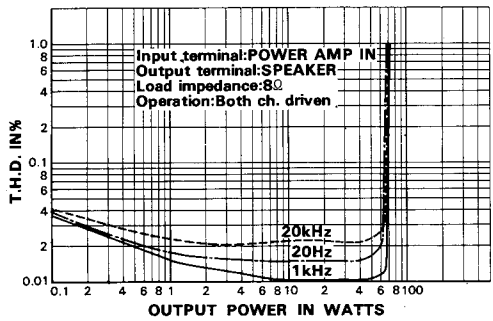

TWIN TONE CONTROLS (SUB)

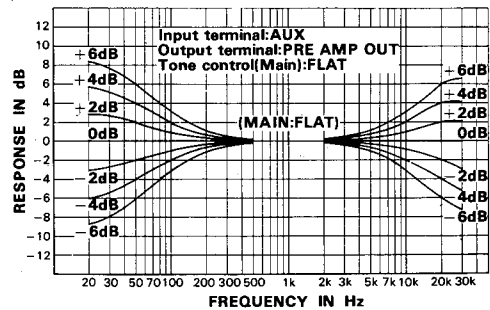

2. SPECIFICATIONS

SEMICONDUCTORS

Transistors 63
Diodes 30

POWER AMPLIFIER SECTION

Circuitry
2-stage Differential Amplifier,
Direct Coupled Pure Com-
plementary OCL

Continuous Power Output
20Hz~20kHz
(Both channels driven) 60W+60W(8Ω), 75W+75W(4Ω)
1kHz
(Both channels driven) 65W+65W(8Ω), 85W+85W(4Ω)
1kHz
(Each channel driven) 75W/75W(8Ω), 100W/100W(4Ω)

Harmonic Distortion
(Continuous Power
Output)
(1W+1W Power
Output)
Less than 0.1%
Less than 0.04%

Intermodulation Distortion
(Continuous Power
Output)
(1W+1W Power
Output)
Less than 0.1%
Less than 0.04%

Power Bandwidth (IHF, Both channels driven)
5Hz~40kHz (H.D. 0.1%)
7Hz~80kHz ±1dB

Frequency Response
Input Sensitivity/Impedance
POWER AMP IN
500mV/50kΩ
Output, Speaker
A,B,C,A+B, A+C (4~16Ω)
Headphones
4~16Ω

Damping Factor
(1kHz, 8Ω)
More than 70

Hum & Noise (IHF, Short-circuited, A Network)
More than 95dB

Residual Hum & Noise (8Ω, Pre & Power-amplifier)
Less than 1mV (0.13 μW)

Subsonic Filter
8Hz (12dB/oct)

PREAMPLIFIER SECTION

Circuitry
Equalizer-amplifier
1st Stage Differential Amplifier,
3-stage Direct Coupled SEPP
NFB type

Control-amplifier
1st Stage Differential Amplifier,
3-stage Direct Coupled NFB type

Input Sensitivity/Impedance

PHONO 1 2.5mV/50kΩ
PHONO 2 2.5mV~10mV/25kΩ, 50kΩ
100kΩ

PHONO Overload Level (rms/p-p)

250mV/700mV

MIC 2.0mV/50kΩ

TUNER 150mV/100kΩ

AUX 1 150mV/100kΩ

AUX 2 150mV~1.5V/50kΩ~100kΩ

TAPE MONITOR 1, 2 150mV/100kΩ

TAPE MONITOR 2 (DIN connector) 150mV/100kΩ

Output Level/Impedance

TAPE REC 1, 2 150mV

TAPE REC 2 (DIN connector) 30mV/80kΩ

PRE AMP OUT 2V/8Ω

Harmonic Distortion
(20Hz~20kHz)
Less than 0.03%

Frequency Response

PHONO (RIAA
equalization)
30Hz~15kHz ±0.2dB

MIC 10Hz~10kHz ±1dB

TUNER, AUX, TAPE
MON 10Hz~70kHz ±1dB

Tone Control

BASS Main Control ±10dB(100Hz)

Sub Control ±6dB(50Hz)

TREBLE Main Control ±10dB(10kHz)

Sub Control ±6dB(20kHz)

Filter

SUBSONIC 8Hz (12dB/oct)

LOW 30Hz (12dB/oct)

HIGH 8kHz, 12kHz (12dB/oct)

Loudness Contour (Volume control set at -40dB position)
+10dB (100Hz)

Hum & Noise (IHF, Short-circuited, A Network)

PHONO More than 80dB

MIC More than 70dB

TUNER, AUX, TAPE
MON More than 90dB

Muting -20dB

Level Set 0dB, -15dB, -30dB

Miscellaneous

Power Requirements
AC 120V 60Hz or AC 110V,
120V, 130V, 220V and 240V
50/60Hz.
(Switchable)

Power Consumption
(Max.) 430W

AC Outlets Switched 1, Unswitched 2

Dimensions (overall) 430(W) x 138(H) x 341(D)mm

16-15/16(W) x 5-7/16(H) x 13-
7/16(D)in.

Weight Without package 13.6kg(29 lb 15oz)

With Package 15.6kg(34 lb 5oz)

Furnished Parts

Connection Cord 1
Polishing Cloth 1
Hex. Wrench 1
Factory-tested Data 1
Operating Instructions 1
5-voltage Model; Fuse 2.5A 1
Fuses 5A 2

NOTE:

Specifications and the design subject to possible modification
without notice due to improvements.

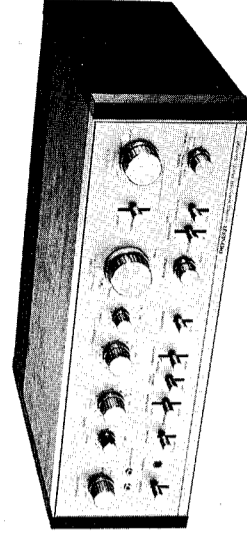

3. CONNECTION DIAGRAM

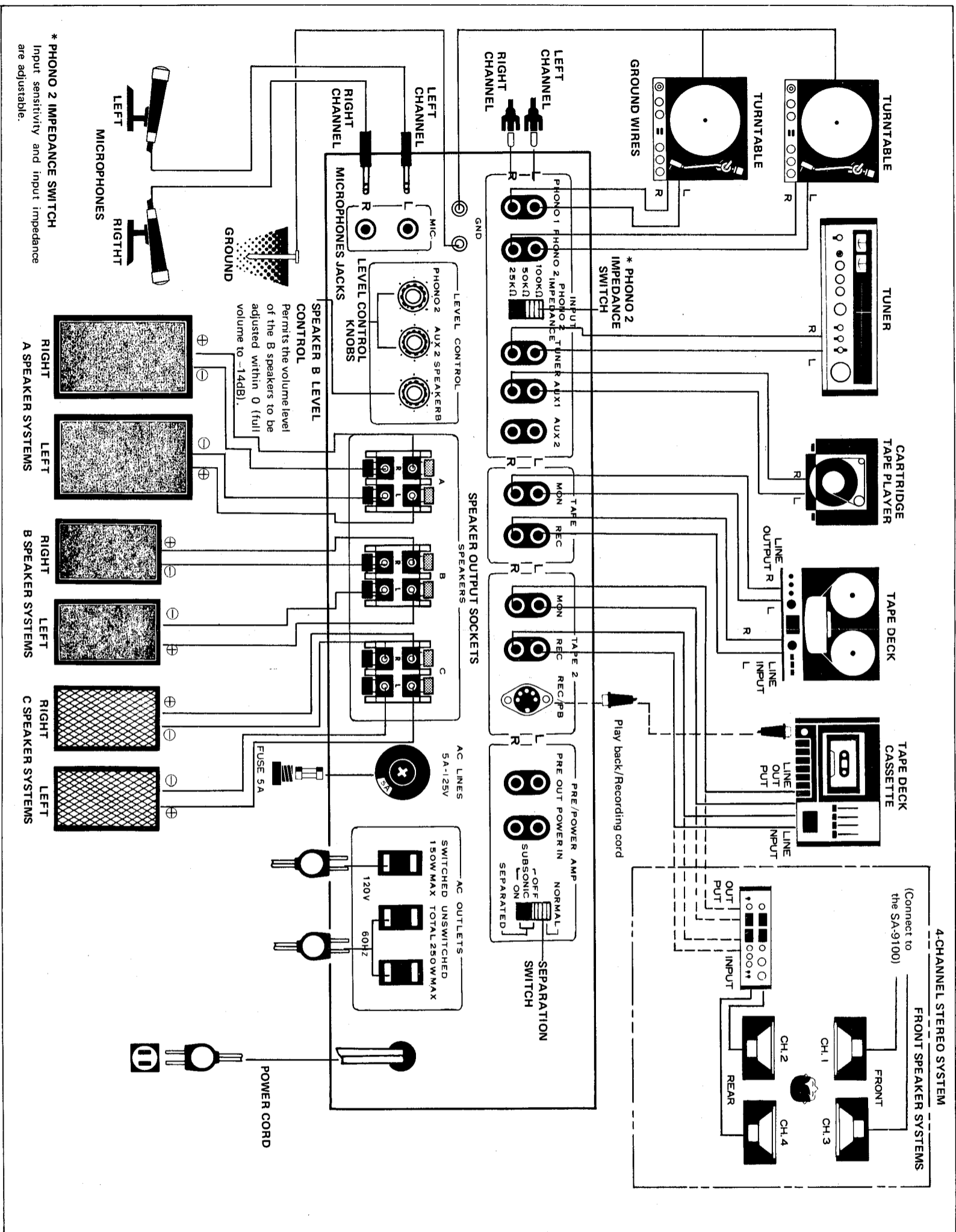

4. FRONT PANEL FACILITIES

BASS CONTROL

This pair of twin controls are for tone adjustments in the bass range.

100Hz knob . . . Controls bass frequencies at and below 400Hz and also at 100Hz by up to ± 10 dB, in click-steps of 2dB.

50Hz knob . . . Re-controls frequency range below 100 Hz of tone quality being controlled by the 100Hz knob and also by up to ± 6 dB, in click-steps of 2dB.

POWER SWITCH, PILOT LAMP

Turns the power to the unit ON and OFF. Also controls the AC outlet marked SWITCHED on the rear panel. The pilot lamp lights when the power is on.

SPEAKERS SWITCH

Selects the speaker system(s) to be driven.

- A Speaker systems connected to speaker outputs A operate.
- B Speaker systems connected to speaker outputs B operate.
- C Speaker systems connected to speaker outputs C operate.
- A+B . . . Both speaker systems A and B operate.
- A+C . . . Both speaker systems A and C operate.
- OFF . . . All speakers off. Use this position when listening through headphones.

PROTECTION PILOT LAMP

When the built-in protector circuit operates to shut off the power to the speakers, this lamp will light. This happens when there's a short-circuit in the speaker leads, or when combined speaker impedance is below 2-ohm, causing overload.

NOTE:

The lamp will also light for 3 to 6 seconds after you turn on the power, and the speakers will remain silent. This is no indication of trouble. The protector circuit is so designed that it will keep the speakers muted for the first few seconds, because they might produce unpleasant noise while the amplifier is still warming up.

HEADPHONE JACK

Stereo headphones can be plugged into this jack. A wide variety of quality headphones is available from Pioneer.

LOW FILTER SWITCH

The low filter is used to eliminate low-frequency noise such as turntable rumble, etc.

SUBSONIC . . . Frequencies below 8Hz are attenuated by 12dB/octave. Although such subsonic frequencies are inaudible to the human ear, they can cause intermodulation distortions and even damage to the loudspeakers. It is advisable to leave the switch in this position at all times, even if no record rumble etc. is heard.

30Hz Frequencies below 30Hz are attenuated by 12dB/octave. Use this position to eliminate record rumble and other low-frequency noise.

OFF No attenuation of low and subsonic frequencies. Use this position for measurements, when the widest possible bass response is required.

TREBLE CONTROL

These twin controls are for tone adjustments in the high sound range.

10kHz knob . . . Controls high-frequencies at and above 2.5kHz and also at 10kHz by up to ± 10 dB in click-steps of 2dB.

20kHz knob . . . Re-controls frequency range above 10 kHz of tone quality being controlled by the 10kHz knob and also by up to ± 6 dB in click-steps of 2dB.

LEVEL SET CONTROL

The outer ring of the volume control serves to limit the output level of the SA-9100. This helps to protect speakers of small power handling ability, but also permits finer volume adjustments at low-to-medium listening levels.

- 30dB . . . Output level reduced by 30dB.
- 15dB . . . Output level reduced by 15dB.
- 0 No reduction. Full output level available.

VOLUME CONTROL

Controls the listening volume. Clockwise rotation increases the volume.

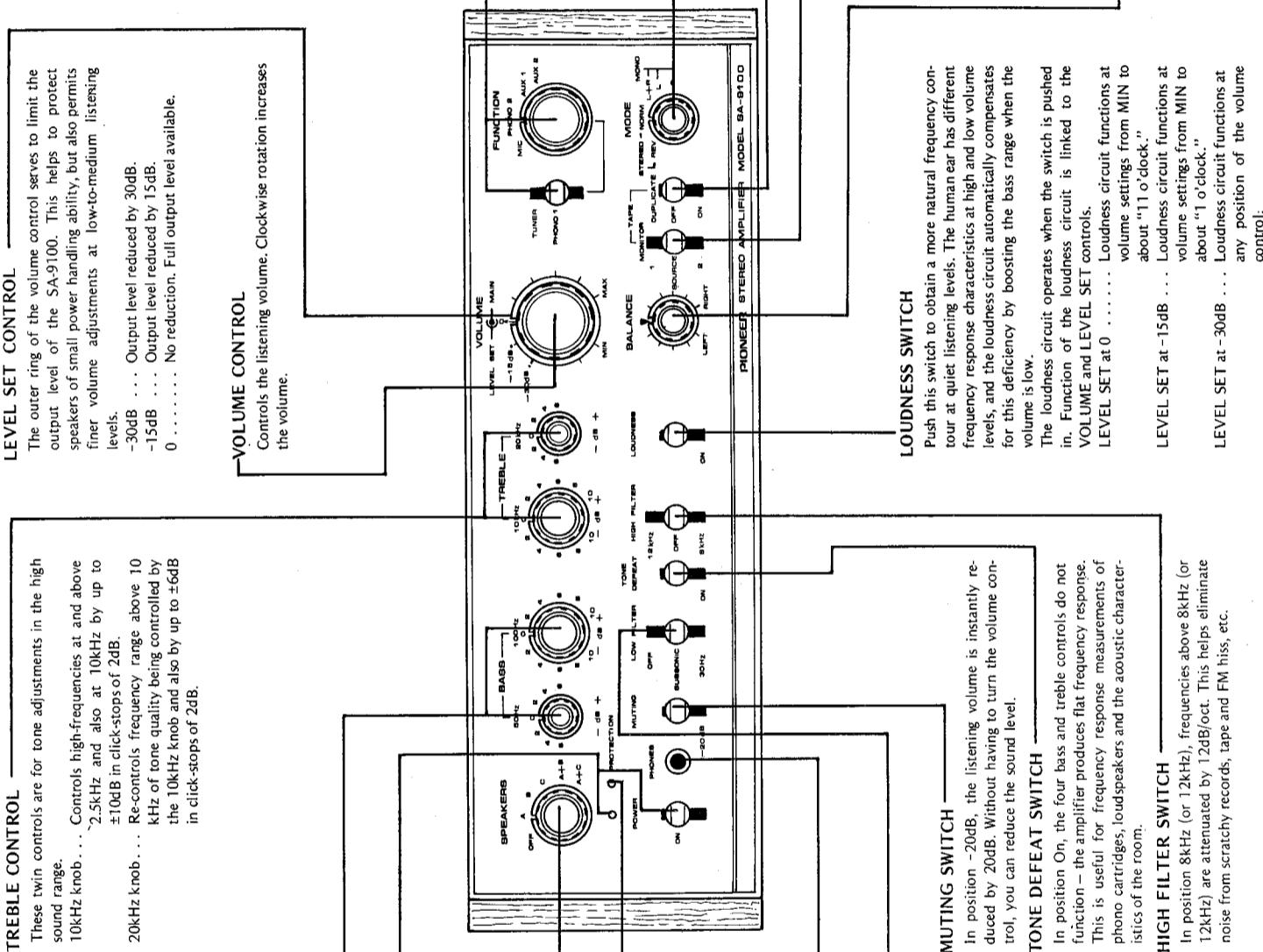

FUNCTION SELECTORS

This combination of a lever switch and a rotary switch selects the program sources to be played.

LEVER SWITCH
TUNER Radio reception with tuner connected to TUNER inputs.

PHONO 1 . . . Operation of turntable connected to PHONO 1 inputs.

When this switch is in bottom position, programs are selected by the rotary switch.

ROTARY SWITCH
MIC Use of microphones plugged into MIC inputs.

PHONO 2 . . . Operation of turntable connected to PHONO 2 inputs.

AUX 1 Program source (cartridge tape player etc.) connected to AUX 1 inputs.

AUX 2 Program source (TV sound track etc.) connected to AUX 2 inputs.

MODE SWITCH

Selects stereophonic and monophonic listening modes.

STEREO NORM . . . Normal stereophonic reproduction.
STEREO REV . . . Stereophonic reproduction with reversed channels: left input signal to right speaker, right input signal to left speaker.

MONO L+R Monophonic reproduction. Mixed left-plus-right signal to both speakers.

MONO L Left input signal to both speakers.

MONO R Right input signal to both speakers.

TAPE DUPLICATE SWITCH

Position ON is used for duplicating a tape with the help of two tape decks. For all other modes of operation, this switch must be left at OFF.

TAPE MONITOR SWITCH

Positions 1 or 2 of this switch are used only for tape playback and for monitoring a tape recording in progress. In all other cases, leave this switch in position SOURCE.

1 Tape playback or monitoring with tape deck connected to TAPE 1 REC outputs and TAPE 1 MON inputs.

SOURCE . . . For all other modes of operation such as record playing, radio reception, etc.

2 Tape playback or monitoring with tape deck connected to TAPE 2 REC outputs and TAPE 2 MON inputs, or to DIN-type REC/PB connector.

BALANCE CONTROL

For balancing the relative sound volume of the left and right channel speakers. Clockwise rotation reduces the volume from the left speaker, counterclockwise rotation decreases the volume from the right speaker.

LOUDNESS SWITCH

Push this switch to obtain a more natural frequency contour at quiet listening levels. The human ear has different frequency response characteristics at high and low volume levels, and the loudness circuit automatically compensates for this deficiency by boosting the bass range when the volume is low.

The loudness circuit operates when the switch is pushed in. Function of the loudness circuit is linked to the VOLUME and LEVEL SET controls.

LEVEL SET at 0 Loudness circuit functions at volume settings from MIN to about "11 o'clock."

LEVEL SET at -15dB . . . Loudness circuit functions at volume settings from MIN to about "1 o'clock."

LEVEL SET at -30dB . . . Loudness circuit functions at any position of the volume control.

5 BLOCK DIAGRAM

SA-9100

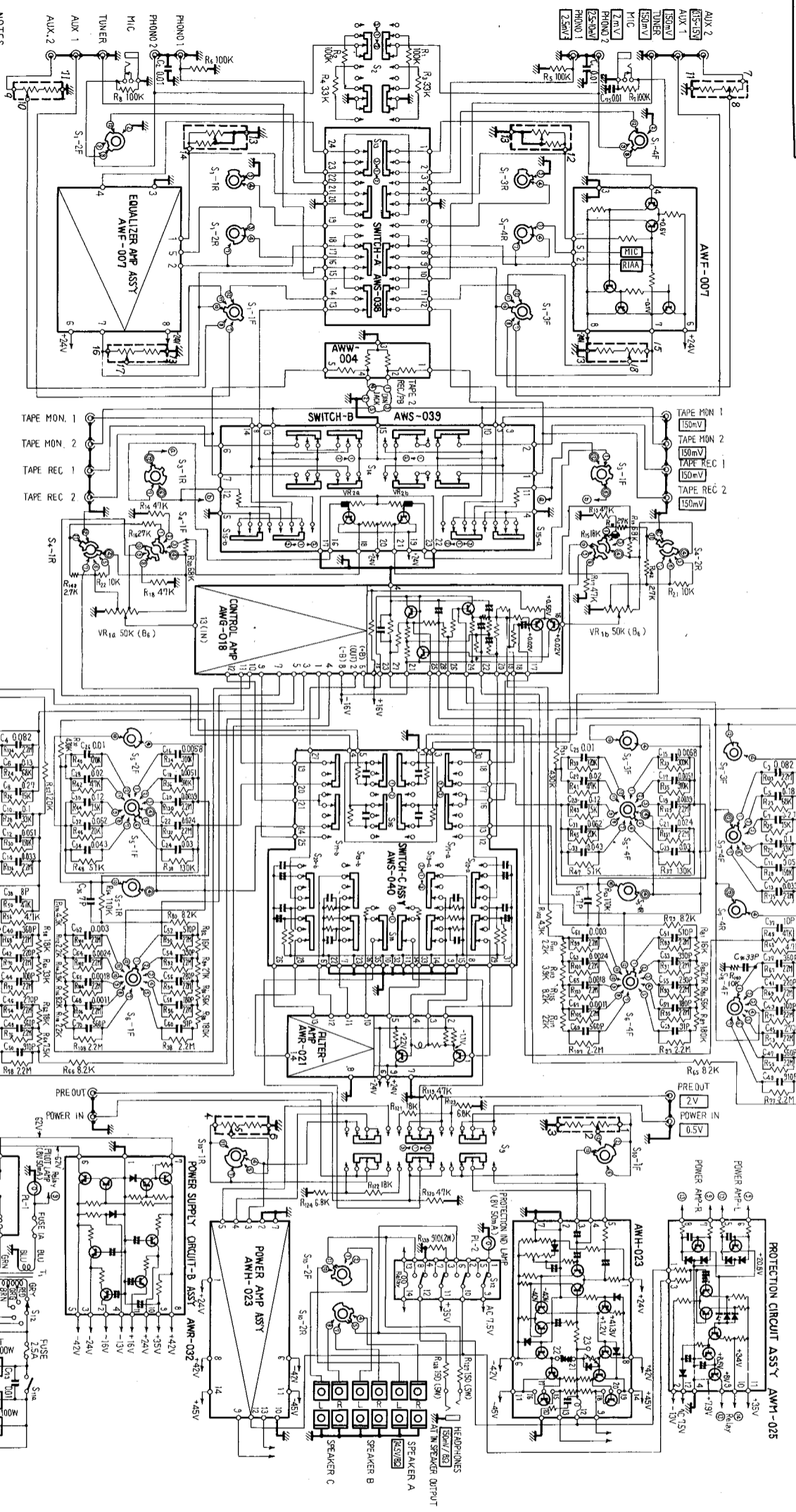

- NOTES**
- SWITCHES**
- S₁: FUNCTION SELECTOR
 - (1) MIC (2) PHONO (3) AUX1 (4) AUX 2
 - (1) -6dB (2) -12dB (3) +6dB 2dB step 20kHz
 - (1) PHONO (2) IMPEDANCE SELECTOR
 - (1) SIMO (2) 25KΩ (3) 10KΩ
 - S₂: MODE SELECTOR
 - (1) REV (2) NORM (3) L (4) L (5) R
 - (1) REV (2) NORM (3) L (4) L (5) R (6) A+B (6) A+C
 - S₃: LEVEL SET
 - (1) -30dB (2) -15dB (3) 0dB
 - S₄: BASS CONTROL
 - (1) -10dB (2) -11) +10dB 2dB step 10kHz
 - S₅: TREBLE CONTROL
 - (1) -10dB (2) -11) +10dB 2dB step 10kHz
 - S₆: BASS CONTROL
 - (1) -10dB (2) -11) +10dB 2dB step 10kHz
 - S₇: TUNE POINT CONTROL
 - (1) -6dB (2) -12dB 2dB step 50Hz
 - (1) SOURCE (2) MON. 2 (3) MON. 1
- POTENTIOMETERS**
- VR₁: VOLUME CONTROL
 - VR₂: BALANCE CONTROL
- RESISTORS**
- IN OHM, 1/2W, ±5% TOLERANCE
 - UNLESS OTHERWISE NOTED, K=KΩ, M=MΩ.
- CAPACITORS**
- IN μF UNLESS OTHERWISE NOTED, P=Pf

- RESISTORS**
- IN OHM, 1/2W, ±5% TOLERANCE
 - UNLESS OTHERWISE NOTED, K=KΩ, M=MΩ.
- CAPACITORS**
- IN μF UNLESS OTHERWISE NOTED, P=Pf

- RESISTORS**
- IN OHM, 1/2W, ±5% TOLERANCE
 - UNLESS OTHERWISE NOTED, K=KΩ, M=MΩ.
- CAPACITORS**
- IN μF UNLESS OTHERWISE NOTED, P=Pf

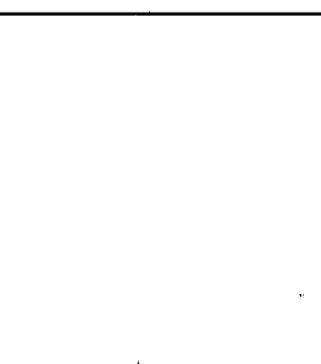
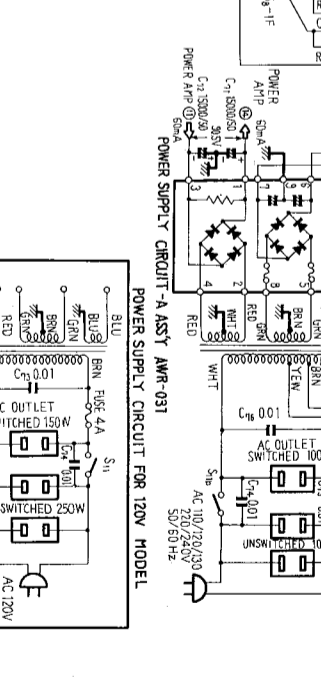

6. CIRCUIT DESCRIPTION

6.1 EQUALIZER AMPLIFIER

The equalizer amplifier is a 3-stage direct coupled single-ended push-pull circuit with a differential amplifier in its first stage. The differential amp transistors (Q1, Q2) are can-sealed type which prevents changes in noise characteristics with the passage of time. The use of a differential amplifier in the first stage permits the application of 100% of DC feedback, resulting in a substantial improvement of DC stability.

By equipping the last stage with a complementary push-pull circuit as commonly used in power amplifiers, power voltage utilization can be improved and output of very low distortion obtained. This design also raises the maximum input handling ability, resulting in a wider dynamic margin.

To assure strict adherence to the RIAA equalization curve, metallized film resistors of $\pm 1\%$ tolerance and styrol capacitors of $\pm 2\%$ tolerance are used. Thus, RIAA deviation remains within $\pm 0.2\text{dB}$ from 30Hz to 15kHz. Gain fluctuations caused by the passage of time are prevented by using a metallized film resistor

of $\pm 1\%$ tolerance at the NFB receiving side.

A variable resistor in series with the dividing resistor for feedback voltage changes the amount of NFB, thus controlling the total gain — this permits phono cartridges of relatively high output voltage to be accommodated without clipping. The phono input circuit has, in other words, more than sufficient dynamic safety margin.

Through the FUNCTION switch the input signal enters the base of Q1. Q1 and Q2 form a differential amplifier. NFB is applied to the base of Q2 to obtain the specified response curve.

R14 is normally grounded, but when the FUNCTION switch is in position PHONO 2, the potentiometer controlled by the LEVEL CONTROL on the rear panel is switched in series into the circuit.

Output from Q1 is amplified in Q3 and then taken out through the A-class complementary circuit formed by Q4 and Q5. A bootstrap circuit is provided to increase the AC load on Q3 and to obtain sufficient loop gain.

EQUALIZER AMP, CIRCUIT SCHEMATIC

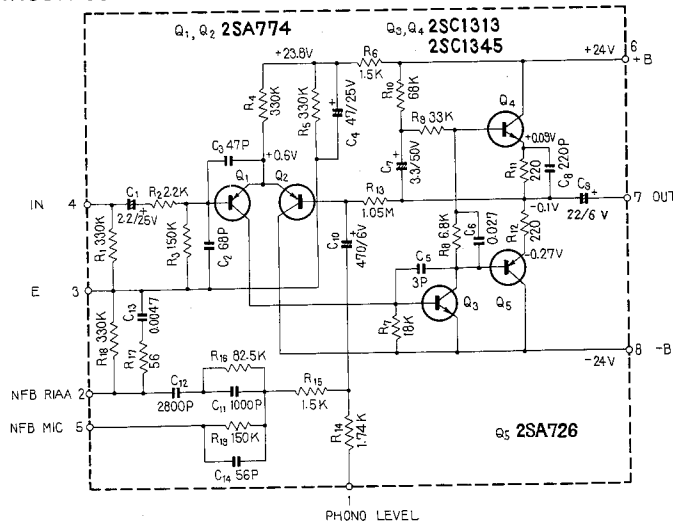

6.2 CONTROL AMPLIFIER

The control amplifier is a 3-stage direct coupled circuit with a differential amp in its initial stage and with so-called "twin tone controls." Adoption of the differential amplifier in the first stage improves DC stability and permits stable higher loop gain operation.

Main as well as sub tone controls operate by switching the CR elements in the feedback path, and precise switching by 2dB steps is possible at all turnover frequencies indicated on

the front panel. In position FLAT, NFB is applied through a resistance only, giving totally flat response characteristics. For accurate and easy system checks and determination of tone control effect, a TONE DEFEAT switch has been provided.

Can-sealed low-noise transistors are used in the first-stage differential amplifier to prevent fluctuations in noise characteristics due to passage of time.

CONTROL AMP, CIRCUIT SCHEMATIC

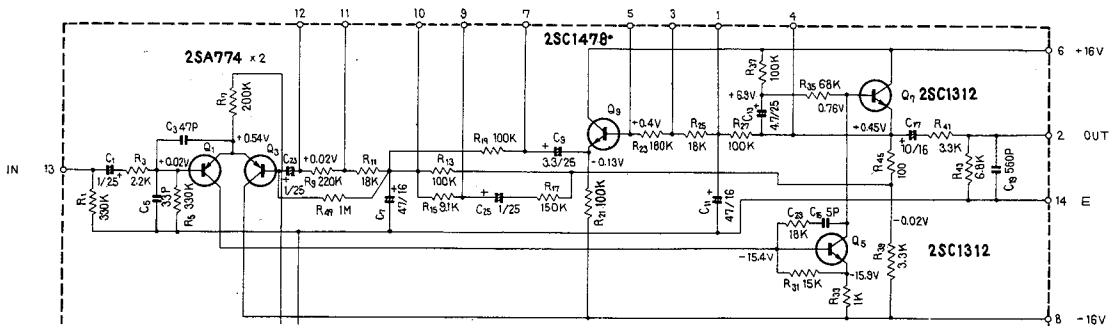

Supply of balanced positive and negative power keeps the DC potential at the inputs and outputs at practically 0V, whereby switching noise is minimized.

The signal from the equalizer amplifier or from the high level input terminals passes through the FUNCTION, TAPE MONITOR, DUPLICATE and MODE switches and through the BALANCE control, then through the emitter-follower in switch circuit-B ass'y and goes to the LEVEL SET switch and VOLUME control. The LOUDNESS contour circuit is interlocked with the LEVEL SET switch whereby its range of effectiveness is changed; with the LEVEL SET at -30dB, the loudness circuit operates over the whole range of the VOLUME control. After adjustment by the VOLUME control, the signal goes to the base of Q1 on the control amplifier assembly. Q1 and Q3 form a differential amp, and the CR elements for negative feedback, selected by switches, are connected to the base of Q3. Output from this differential amplifier goes from the collector of Q1 to the base of Q5.

The output from Q5 undergoes a change of impedance in the Q7 emitter-follower circuit, then goes to the next stage at low impedance. To assure precise, effective operation of the twin tone controls, an emitter-follower circuit (Q9) has been included between the main and sub controls, preventing mutual interference between these controls.

6.3 FILTER AMPLIFIER

From the control amplifier, the signal passes through low cut and high cut filters where unwanted portions are filtered out, and then enters the power amplifier. The low cut filter, with Q1, provides 12dB/oct. cut-off at either 30Hz or 8Hz (SUBSONIC). The high cut filter uses an LC network for 12dB/oct. cut-off at 8kHz or 12kHz frequency.

6.4 POWER AMPLIFIER

The power amplifier is a pure complementary direct coupled OCL design with two differential amplification stages. The two-stage differential amplifier and the bias compensation circuit result in extremely good DC stability, preventing practically completely any generation of DC potential at the output junction caused by changes in the operating ambient temperature. Moreover, constant-current circuits are included at two stages to prevent changes in idle current due to AC line voltage fluctuations, which in turn precludes the generation of transient crossover distortions. Because of the 3-stage quasi-Darlington circuit provided with the constant-current drive, the predriver (Q3) operation could be help, distortion decreased and relatively high loop gain obtained. In both the driver and last stages, special PNP and NPN transistors of precisely matched characteristics are employed. Left and right channel circuits are not combined on one circuit board but are separated into two monophonic amplifiers. This not only improves heat dissipation but also prevents inequality in ultra-high frequency response caused by slight differences in the PC Boards copper film conductor pattern. Utmost operational safety is assured by using transistors of very high strength, by providing large-sized heat sinks, by including a current limiter circuit, and by installing an electronic protection circuit. The input signal enters the base of Q1. AC and DC negative feedback is applied to the base of Q2. The balanced output from the collectors of Q1 and Q2 enters the bases of Q3

and Q4 (the differential amplifier), respectively. The constant-current circuit (Q5) and the input impedance of the emitter-follower (Q6) reduce the operating load on Q3.

The signal from Q3 undergoes current amplification in Q6 and is then power-amplified in the output stages Q8~Q11. The emitter side load of Q6 is maintain to high impedance by the constant-current circuit formed by Q7.

DC negative feedback from the output junction is applied to the base of Q2 through R33, R34 and R35, while AC NFB goes to the base of Q2 through R33 and R35.

To maintain DC potential at the output junction at 0V, a bias circuit formed by D1, R6, R7, R8, R9, R10 and VR1 is provided. D1 is included for perfect temperature compensation. The idle current limiter circuit is formed by VR4 and D4. Varistor D4 consists of four diode unit analog to the VBE of the driver and power transistors and to their temperature characteristics. Diode D3, in parallel with VR2, acts as protection if, by some trouble, VR2 should become non-conductive. D6 is a current limiting diode protecting against excessively high input.

To improve stability in the high-frequency range, high range phase compensation is performed by the following circuit: C4, C7, R14, C8, R15, C9, C11, R31, L1 and R32. C10, by providing a smooth outlet for the base storage carrier of Q10 and Q11, reduces high range notching distortion, thereby improving overall distortion characteristics.

POWER AMP, CIRCUIT SCHEMATIC

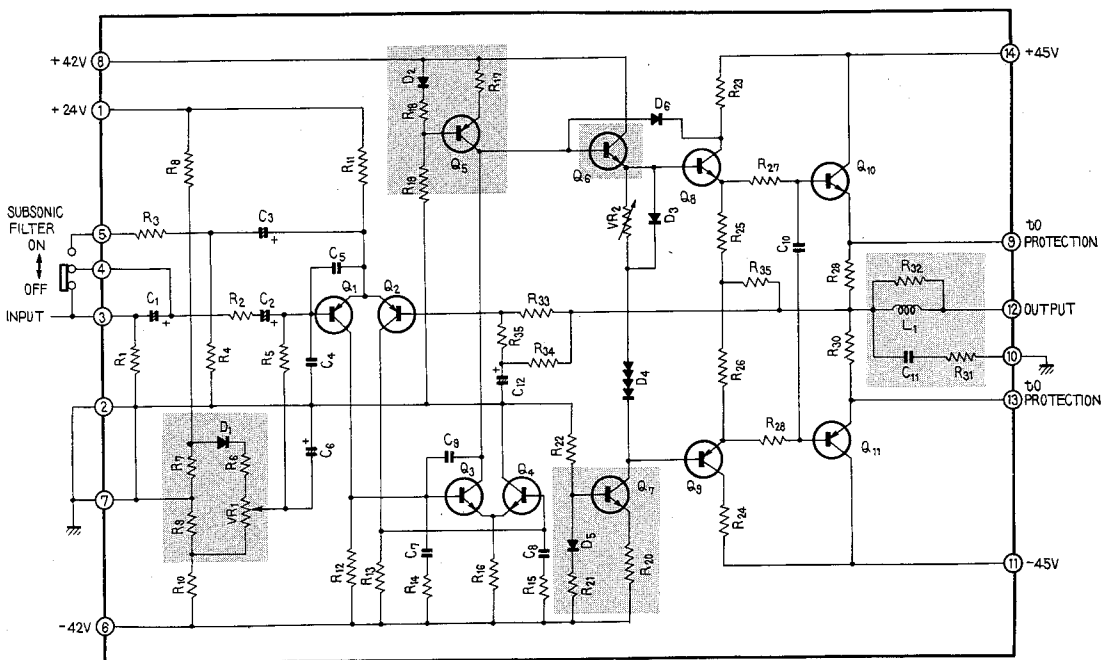

R23, R27, R24 and R28 are protective resistors which limit current flow under low-load conditions.

Output from the power amplifier passes through the relay points and the SPEAKERS switch to the speaker output terminals and the headphone jack.

6.5 PROTECTION CIRCUIT

The protection circuit comprises 7 transistors. Of these, Q1 and Q2 serve to detect excessive current in the power amplifier and short-circuiting of the output load (speaker leads, etc.). Each transistor serves one channel.

Q3 and Q4, constituting a differential amplifier, detect DC potential at the power amplifier output; this circuit is common for both channels. Transistors Q5 to Q7 are the relay driving circuit. When the power switch is turned off, negative voltage is applied to the base of Q6 to open the relay smoothly.

And CR time constant circuit is connected to the base of Q7. This mutes the output immediately upon switch-on and controls the reset time of the relay.

6.6 POWER SUPPLY CIRCUIT

All circuits — with the exception of the protection circuit — are supplied with balanced positive and negative power, which substantially improves operating stability. There are two sets of bridged rectifier circuits for this purpose. One set exclusively supplies the power amplifier. After rectification, ripple voltage takes off by through a 15,000 μ F capacitor. The other rectifier set supplies all other circuits with power. After rectification, voltage stabilization and passage through a ripple filter, power is supplied with low impedance.

7. DISASSEMBLY

1. To remove the wooden case, remove the two screws on either side, then lift the back end of the case upward.
2. Pull off all control knobs. The LEVEL SET knob must be first loosened with a hex. wrench.
3. Remove the three screws each from the top and bottom edges of the front panel, then gently pull the panel forward.
4. To remove the bottom panel, first remove the 9 screws holding it in place.
5. Adjustment procedures

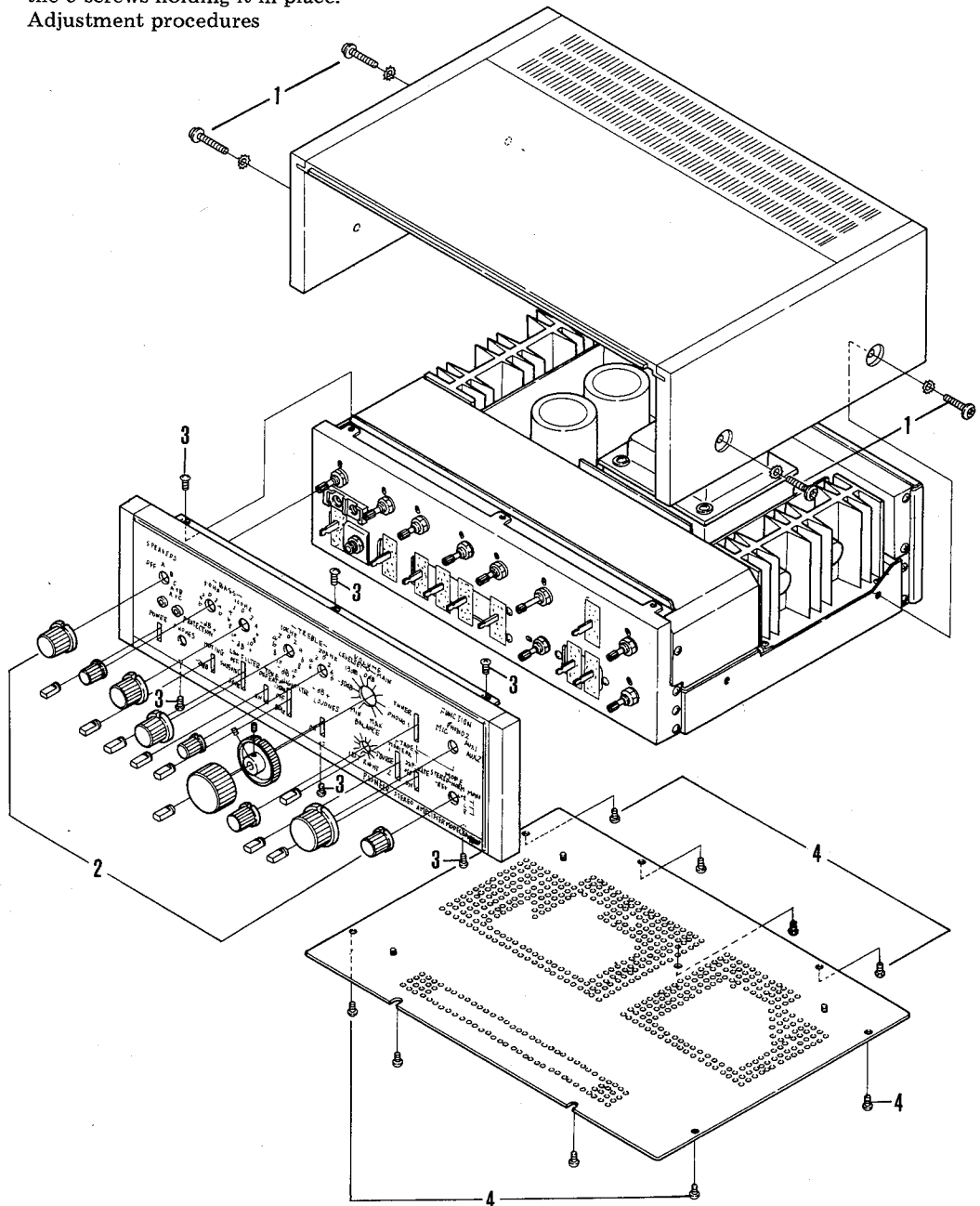

8. PARTS AND P.C. BOARD LOCATION

8.1 TOP VIEW

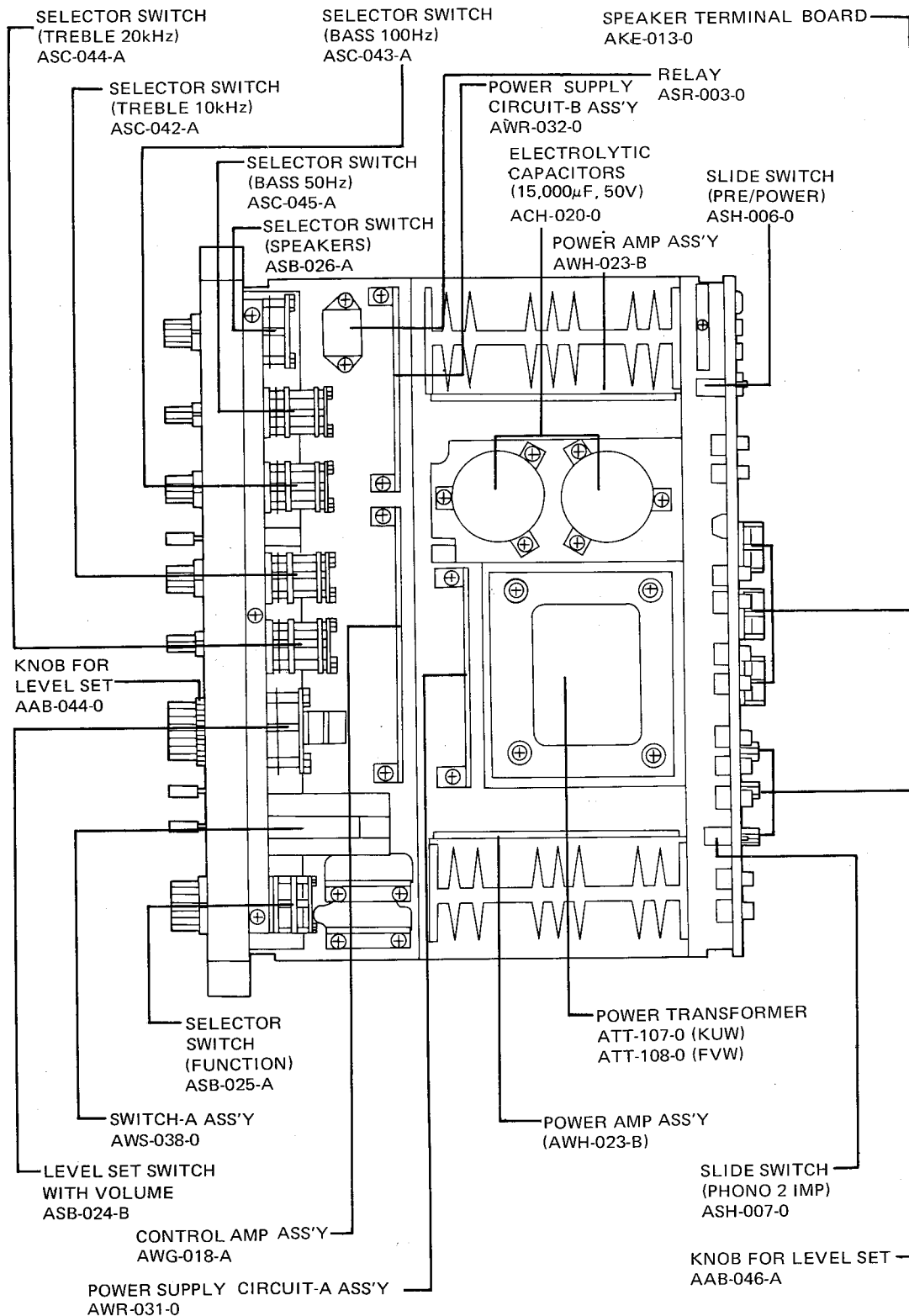

8.2 BOTTOM VIEW

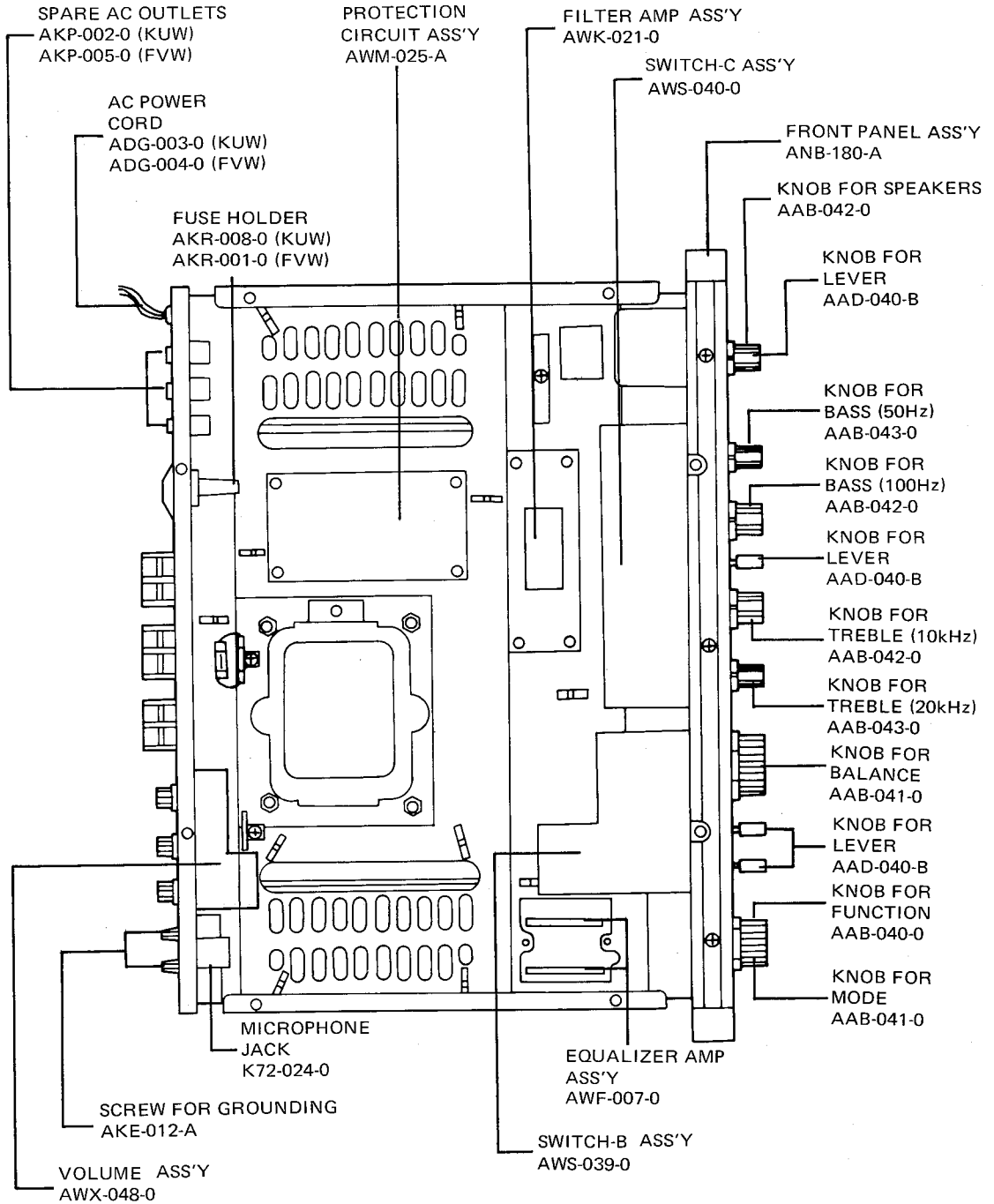

9. ALIGNMENT PROCEDURE

The SA-9100 has two separate power amp boards. As viewed from the front, the left circuit board is the left channel power amp, the right circuit board, is the right channel power amp.

Adjustment procedures are identical for both channels, so the explanations below are given for one channel only. All adjustments are required to be made on both channels, however.

9.1 IDLE CURRENT ADJUSTMENT

1. Remove output load. Without applying input, terminate input terminals (terminals no.3) with $4.7\text{ k}\Omega$ resistance.
2. Set VR1 at approximately center position, turn VR3 all the way counterclockwise. Then turn on power

3. Allow approximately 20 minutes warm-up time. Then adjust VR3 to obtain a voltage reading of 25mV between terminals no. 9 and 13.

9.2 ADJUSTMENT OF NEUTRAL POTENTIAL

1. Remove output load. Terminate input terminals of circuit board with $4.7\text{ k}\Omega$ resistance, then turn on power.
2. Allow approximately 20 minutes warm-up time. Then adjust VR1 to obtain a voltage reading of $0\text{V} \pm 10\text{mV}$ between terminal no. 23 and ground.

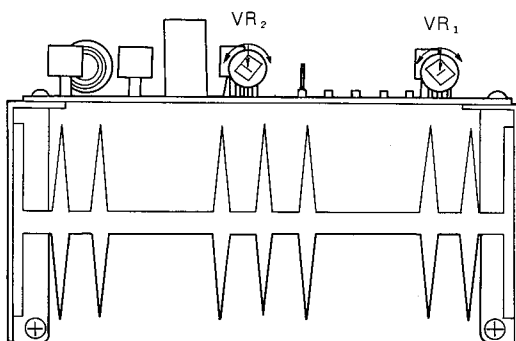

10. EXPLODED VIEW AND PARTS LIST

Parts List of Exploded View

NOTICE:

Any parts asterisked * are subject to being not supplied.

Key No.	Description	Part No.
1*	Front shield cover	ANH-133-0
2	Power amp ass'y	AWH-023-B
3	Power transformer for KUW model	ATT-107-0
	Power transformer for FVW model	ATT-108-0
4*	Rear shield cover	ANH-119-0
5	Power amp ass'y	AWH-023-B
6*	4P terminal strip	AKC-021-0
7	Electrolytic capacitor 15,000 μ F 50V	ACH-020-0
8	Electrolytic capacitor 15,000 μ F 50V	ACH-020-0
9	Power supply circuit-A ass'y	AWR-031-0
10	Power supply circuit-B ass'y	AWR-032-0
11	Control amp ass'y	AWG-018-A
12*	Wire clip-A	AEC-004-0
13	Relay	ASR-003-0
14	AC power cord for KUW model	ADG-003-0
	AC power cord for FVW model	ADG-004-0
15*	AC cord stopper	AEC-079-0
16	5P connector (DIN type)	K93-003-B
17*	Switch stopper	AEC-086-0
18	Knob for level control	AAB-046-A
19	Screw for grounding	AKE-012-A
20*	Rear panel	ANC-074-0
21	Slide switch (PRE/POWER)	ASH-006-0
22	Spare AC outlet for KUW model	AKP-002-0
	Spare AC outlet for FVW model	AKP-005-0
23	Fuse holder for KUW model	AKR-008-0
	Fuse holder for FVW model	AKR-001-0
24	Speaker terminal board (triple type)	AKE-013-0
25	Six fold phono jack-B	AKB-017-0
26	Slide switch (PHONO 2 IMP)	ASH-007-0
27	Four-fold phono Jack-B	AKB-015-0
28	Four-fold phono jack-A	AKB-014-0
29	Four-fold phono jack-A	AKB-014-0
30	Microphone jack	K72-024-0
31	Volume ass'y	AWX-048-0
32	Equalizer amp ass'y	AWF-007-0
33*	Chassis	ANA-036-B
34*	Boss	AEB-019-0
35	Protection circuit ass'y	AWM-025-A
36	Filter amp ass'y	AWK-021-0
37*	4P ground terminal	K13-047-0
38	Selector switch (MODE)	ASB-022-A
39	Selector switch (FUNCTION)	ASB-025-A
40*	2P terminal strip	AKC-015-0

Symbol	Description	Part No.	
41	Switch-A ass'y	AWS-038-0	
42	LEVEL SET switch with VOLUME	ASB-024-B	
43*	4P terminal strip	AKC-021-0	
44	Selector switch (TREBLE 20kHz)	ASC-044-A	
45	Selector switch (TREBLE 10kHz)	ASC-042-A	
46	Selector switch (BASS 100Hz)	ASC-043-A	
47	Selector switch (BASS 50Hz)	ASC-045-A	
48	Selector switch (SPEAKERS)	ASB-026-A	
49	Pilot lamp for indicator	AEL-007-0	
50	Pilot lamp for protection	AEL-014-0	
51*	Cushion	AEB-030-0	
52*	Light shade	AED-018-0	
53	Headphone jack	K72-026-0	
54	Lever switch (POWER) for KUW model	ASK-039-0	
	Lever switch (POWER) for FVW model	ASK-040-0	
55	Switch-C ass'y	AWS-040-0	
56	Switch-B ass'y	AWS-039-0	
57*	Wire clip-D	AEC-024-0	
58*	Shield cover	ANH-148-0	
59*	Shield board	ANH-138-0	

